



OWNER'S MANUAL

SXS

REFRIGERATOR

Please read this manual carefully before operating your set and retain it for future reference.

(In the UK Only)**Important**

The wires in this mains lead are coloured in accordance with the following code:

GREEN AND YELLOW: EARTH

BLUE: NEUTRAL

BROWN: LIVE

This appliance must be earthed

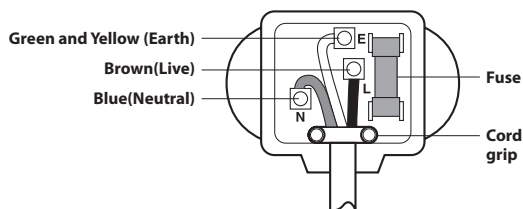

As the colours of the wires in the mains lead of this apparatus may not correspond with the coloured markings identifying the terminals in your plug, proceed as follows:

The wire which is coloured Green and Yellow must be connected to the terminal in the plug which is marked with the letter E or by the earth symbol (\perp) or coloured Green or Green and Yellow.

The wire which is coloured Blue must be connected to the terminal which is marked with the letter N or coloured Black.

The wire which is coloured Brown must be connected to the terminal which is marked with the letter L or coloured Red.

If a 13 amp (BS 1363) plug is used, fit a 13 amp BS 1362 fuse.

Table of contents

Introduction	Entry _____	4
	Important safety instructions _____	4
	Identification of parts _____	6
Installation	Where to install _____	8
	Door removal _____	8
	Door replacement _____	9
	Feed water pipe installation (Dispenser model only) _____	10
	Door height adjustment _____	10
Operation	Starting _____	12
	Adjusting the temperature and functions _____	12
	Dispenser use (on some model) _____	18
	Two stars section (Applicable to some models only) _____	22
	Refreshment centre(Applicable to some models only) _____	22
	No Plumbing Ice & Water (Applicable to some models only) _____	23
	Shelf (Applicable to some models only) _____	24
	Wine holder (Applicable to some models only) _____	24
	Egg box (Depends on model) _____	24
	V Fresh (Option not available for all models) _____	25
	Fresh 0 Zone (Applicable to some models only) _____	26
	Usage of door rack (option) _____	26
	Opti Temp Zone Temperature Transition Corner (Applicable to some models only) _____	27
	Temperature Change at Opti Temp Zone (Applicable to some models only) _____	27
Opti Temp Zone Temperature Transition Corner (Applicable to some models only) _____	27	
Suggestion on food storage	Location of foods _____	28
	Storing foods _____	29
	Suggestion for energy saving _____	29
Care and maintenance	How to dismantle parts _____	30
	General information _____	32
	Cleaning _____	32
	Troubleshooting _____	34

Entry

The model and serial numbers are found on the inner case on the back or one side of the refrigerator compartment of this unit. These numbers are unique to this unit and are not available to others. You should record requested information here and retain this guide as a permanent record of your purchase. Staple your receipt here.

Date of purchase : _____
 Dealer purchased from : _____
 Dealer address : _____
 Dealer phone no. : _____
 Model no. : _____
 Serial no. : _____

Important safety instructions

Before it is used, this refrigerator must be properly installed and located in accordance with the installation instructions in this document. This Refrigerator is intended for Domestic indoor use only.

Never unplug your refrigerator by pulling on the power cord. Always grip plug firmly and pull it straight out from the outlet.

When moving your appliance away from the wall, be careful not to roll over the power cord or to damage it in any way.

After your refrigerator is in operation, do not touch the cold surfaces in the freezer compartment, particularly when your hands are damp or wet. Skin could adhere to these extremely cold surfaces.

Unplug the power cord from the power outlet for cleaning or other maintenance. Never touch the appliance with wet hands as you may receive an electric shock or injure yourself.

Never damage, press, severely bend, pull or twist the power cord as damage to the cord may cause fire or electric shock. Never touch the cord if you are uncertain if the appliance is correctly earthed.

Never place glass items in the freezer as they may break due to expansion of their contents on freezing.

Never put your hands into the storage bin of the automatic ice maker as you could be injured during its operation.

The appliance is not intended for use by young children or infirm persons without supervision.

Young children should be supervised to ensure that they do not play with the appliance.

Never allow anyone to climb, sit, stand or hang on the refreshment centre door. These actions may damage the refrigerator and even tip it over, causing severe personal injury.

It is advised that this appliance should be connected through an independent power socket to prevent it and other appliances from overloading the circuit and causing a power outage.

The appliance should be positioned so that the supply plug is easily accessible for quick disconnection should an accident occur.

If the supply cord is damaged, it must be replaced by the manufacturer or its service agent or a similarly qualified person in order to avoid a hazard.

- Do not modify or extend the Power Cord length. It may cause electric shock or fire.



Don't use an extension cord

Accessibility of Supply Plug Supply Cord Replacement

 Warning

Child entrapment

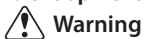

Warning

DANGER: Risk of child entrapment.

Before you dispose of your old refrigerator please remove doors but leave the shelves in place so that children cannot climb inside.

This appliance is not intended for use by persons (including children) with reduced physical, sensory or mental capabilities, or lack of experience and knowledge, unless they have been given supervision or instruction concerning use of the appliance by a person responsible for their safety.

Children should be supervised to ensure that they do not play with the appliance.

Do not store or use gasoline or other flammable vapour and liquids in the vicinity of this or any other appliance.

In the event of an electric short circuit, grounding (earthing) reduces the risk of electric shock by providing an escape wire for the electric current.

In order to prevent possible electric shock this appliance must be earthed. Improper connection of the earthing plug can cause electric shock. Consult a qualified electrician or service engineer if the earthing instructions are not completely understood, or if you have doubts as to whether the appliance is properly earthed.



Don't store

Warning

Grounding

(Earthing)





Warning





Warning

 Keep ventilation openings in the room where the appliance is installed clear of obstruction.

 Do not use mechanical devices or other means to accelerate the defrosting process, other than those recommended by the manufacturer.

 Do not damage the refrigerant circuit.

 Do not use electrical appliances inside the food storage compartments of the appliance, unless they are of the type recommended by the manufacturer.

 Disposal procedures. If disposing of this appliance, please consult with a service agent or a similarly qualified person for more details.



This appliance may contain (Check the rating/compliance label for the refrigerant type and amount. Applicable to some models only) a small amount of isobutane refrigerant (R600a),

natural gas with high environmental compatibility, but it is also combustible.

When transporting and installing the appliance, care should be taken to ensure that no parts of the refrigerating circuit are damaged. Refrigerant squirting out of the pipes could ignite or cause an eye injury. If a leak is detected, avoid any naked flames or potential sources of ignition and air the room in which the appliance is standing for several minutes.

In order to avoid the creation of a flammable gas air mixture if a leak in the refrigerating circuit occurs, the size of the room in which the appliance may be sited depends on the amount of refrigerant used. The room must be 1m² in size for every 8g of R600a refrigerant inside the appliance. The amount of refrigerant in your particular appliance is shown on the identification plate inside the appliance. Never start up an appliance showing any signs of damage. If in doubt, consult your dealer.

Identification of parts

*Non dispenser model - Type 1

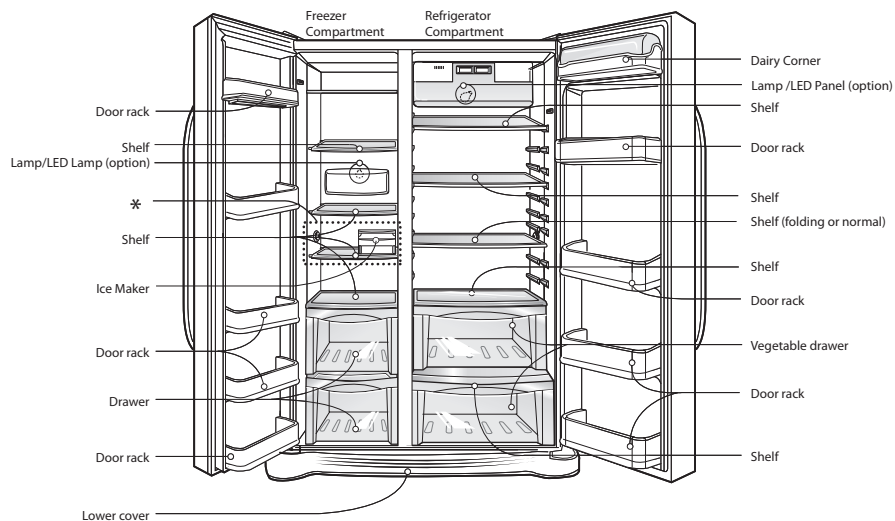

NOTE

- Parts, features, and options vary by model. Your model may not include every option.

*Non dispenser model - Type 2

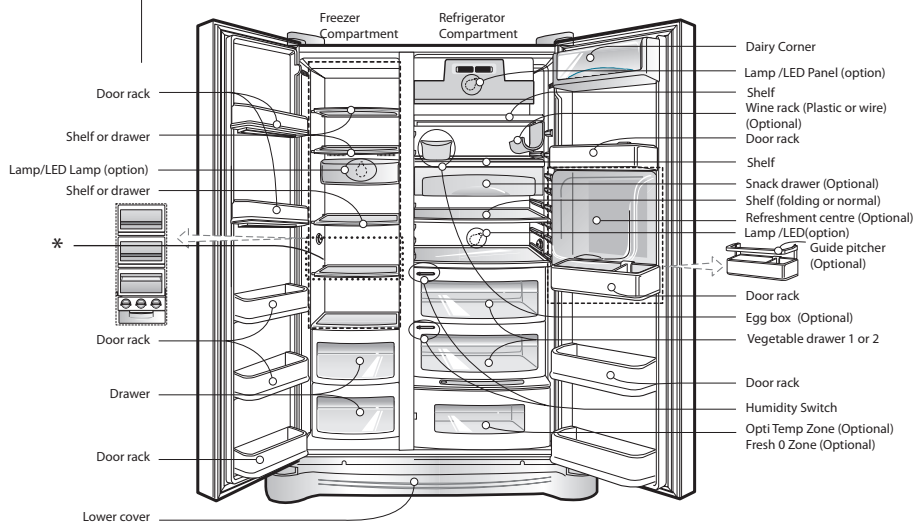

NOTE

- Parts, features, and options vary by model. Your model may not include every option.

* The process of freezing occurs the fastest on the marked shelf.

***Dispenser model - Type 1**

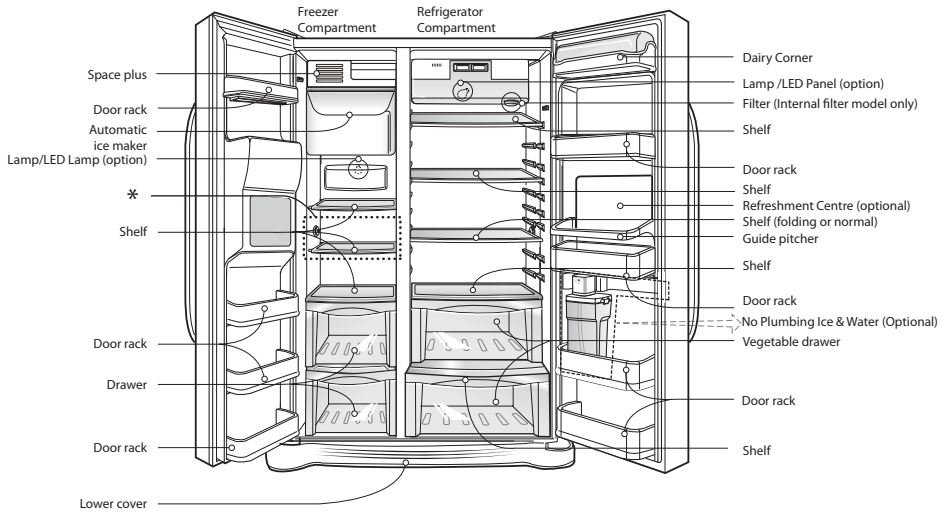

NOTE

- Parts, features, and options vary by model. Your model may not include every option.

***Dispenser model - Type 2**

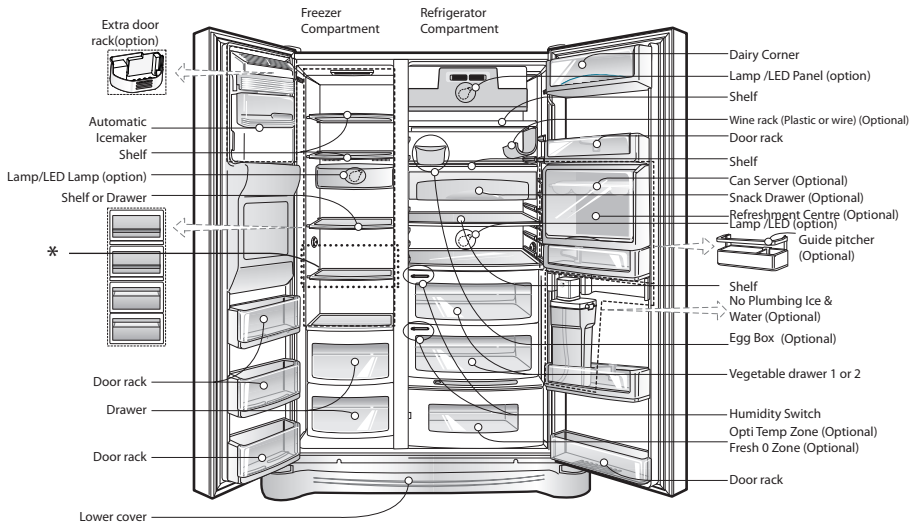

NOTE

- Parts, features, and options vary by model. Your model may not include every option.

* The process of freezing occurs the fastest on the marked shelf.

Select a good location

Where to install

1. Place your appliance where it is easy to use.
2. Avoid placing the unit near heat sources, direct sunlight or moisture. Do not operate the appliance outdoors where it can be exposed directly, or indirectly to sun, wind and rain.
3. To ensure proper air circulation around the fridge -freezer, please maintain sufficient space on both the sides as well as top and maintain at least 2 inches (5 cm) from the rear wall.
4. To avoid vibrations, the appliance must be levelled.
5. Do not install the appliance in temperatures of less than 5°C as the performance may be affected.

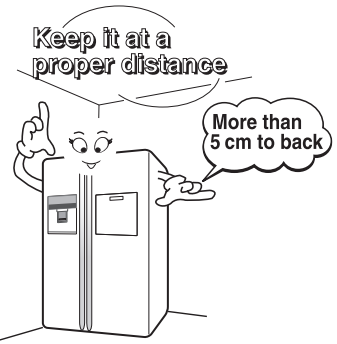

Disposal of the old appliance

This appliance contains fluid (refrigerant, lubricant) and is made of parts and materials which are reusable and/or recyclable. All the packaging materials should be sent to the collection centre for recycling. For details of your local recycling centre, please contact your local council.

Door removal

Electric Shock Hazard

Disconnect electrical supply to refrigerator before installing. Failure to do so could result in death or serious injury.

If your front door is too narrow to get the refrigerator into the house, remove the refrigerator doors and pass the appliance through laterally.

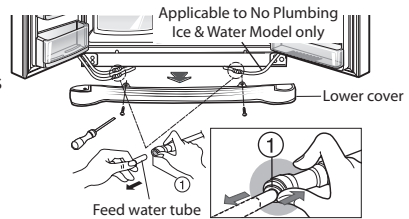

Remove the lower cover by loosening all the screws. Then push in the feed water tube while depressing the connector, as shown in the illustration on the right.

NOTE
• If a tube end is deformed or abraded, trim the end with sharp knife until perfectly round.

Remove lower cover and then feed water tube

- 1) Remove the hinge cover by loosening the screws. Then separate all connection wires except for the earth.

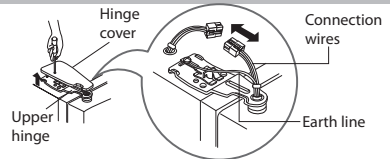

- 2) Remove the keeper by rotating it counter clockwise (1) and then lifting the upper hinge up (2).

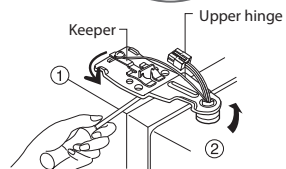

Remove the freezer compartment door

NOTE
• When removing the upper hinge, be careful that the door does not fall forwards.

- Remove the freezer compartment door by lifting it upward. The door should be lifted high enough for the feed water pipe tube to be completely pulled out.

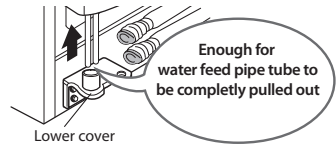

NOTE

- If you have removed the refrigerator compartment door to pass the appliance through an access door, lay the door down, but be careful not to damage the feed water pipe tube.

Remove the refrigerator compartment door

- Loosen the hinge cover screws and remove the cover. Remove connection wires, if any, except for the earth line.

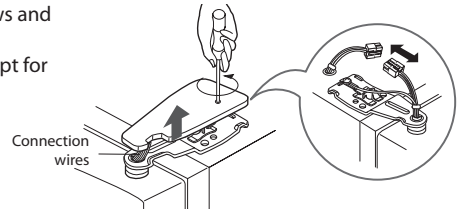

- Remove keeper by rotating it clockwise (1) and then remove the upper hinge by lifting it up (2).

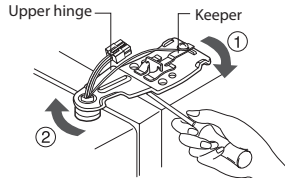

- Remove the refrigerator compartment door by lifting it up.

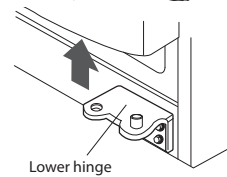

Pass the refrigerator

- Pass the refrigerator laterally through the access door as illustrated to the right.

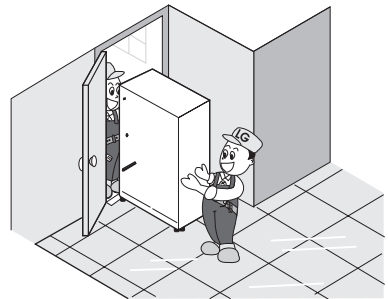

Door replacement

- Once the fridge is through the access door, remount the fridge doors by following the door removal instructions in reverse.

Feed water pipe installation (Dispenser model only)

Before installation

- Automatic ice maker operation needs water pressure of 147~834kPa (1.5~8.5kgf/cm²) (The pressure is correct when an instant paper cup (180cc) is filled in 3 sec.).
- If water pressure does not reach the rating 147kPa(1.5kgf/cm²) or below, it is necessary to purchase a separate pressure pump for normal automatic icing and cool water feed.
- Keep the total length of the feed water pipe tube within 8m and be careful that the tube does not bend. If the tube is 8m or longer it may cause water feed problems owing to the drain water pressure.
- Install the feed water pipe tube at a place free from heat.
- Connect to drinking water supply only.
- Refer to instructions with water filter kit for installation.



Warning

Door height adjustment

Level the door by inserting flat(-) type driver into the groove of the left height adjusting screw and rotate it clockwise (⌚).

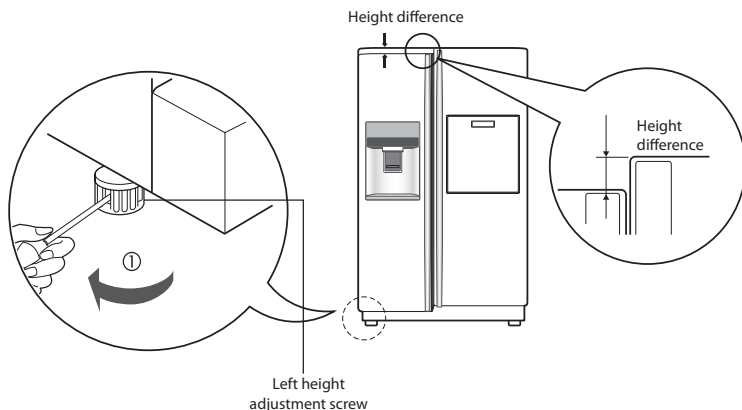

If the freezer compartment door is lower than the refrigerator compartment door

Level the door by inserting flat(-) type driver into the groove of the left height adjusting screw and rotate it clockwise (⌚).

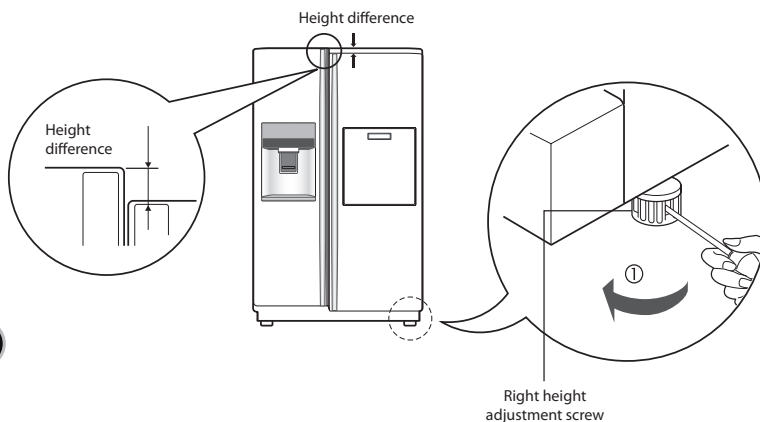

If the freezer compartment door is higher than the refrigerator compartment door

If the freezer compartment door is lower than the refrigerator compartment door (on some model)

Insert the transparent sheet supplied with the product when the freezer door is lower than the refrigerator door

Separate the door with the lower height, use the (+) type screwdriver to unscrew the screw at the bottom hinge as shown at Figure (1), insert the transparent sheet between the bottom hinge and the bottom bracket, and then fix it with the screw as shown at Figure (2)

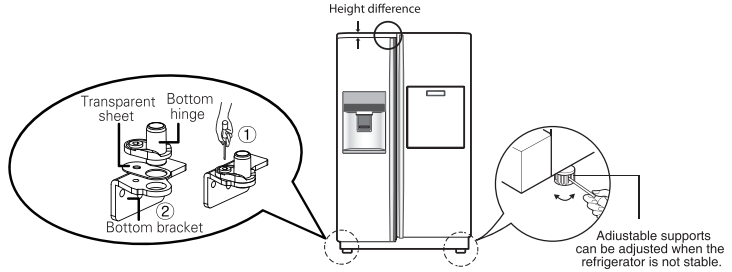

If the freezer compartment door is higher than the refrigerator compartment door (on some model)

Make adjustments when the refrigerator door is lower than the freezer door while using the refrigerator.

Use the adjustment tool (1) to rotate the adjustment hinge pin (2) in either clockwise or counterclockwise direction to level the height of the refrigerator to that of the freezer.

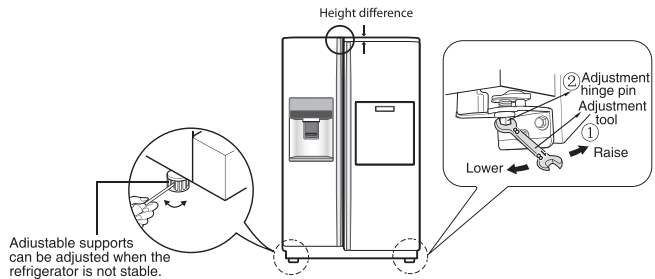

Warning

Do not adjust the height excessively. You can lose the hinge pin.
Height adjustable range: Maximum of 5mm)

After levelling the door height

Next

1. Wipe off all dust accumulated during shipping and clean your appliance thoroughly.
2. Install accessories such as the ice cube box, cover evaporating tray, etc., in their proper places. They are packed together to prevent possible damage during shipping.
3. Connect the power supply cord (or plug) to the outlet. Don't double up with other appliances on the same outlet.

Starting

When your refrigerator is first installed, allow it to stabilize at normal operating temperatures for 2-3 hours prior to filling it with fresh or frozen foods. If operation is interrupted, wait 5 minutes before restarting.

Adjusting the temperature and functions

*Non dispenser model - Type 1

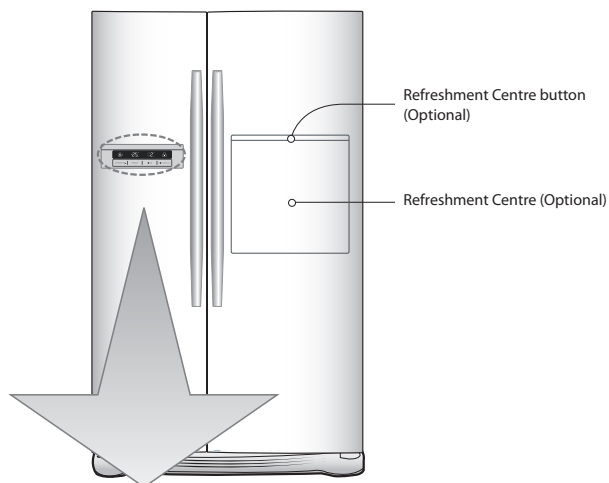

Function display board

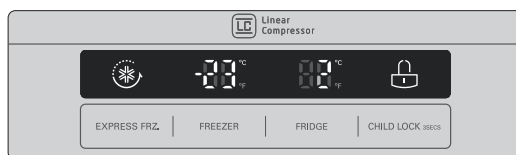

NOTE

- Your model may not include every option.
- The control display is touch operated. Excessive moisture on the display panel may result in its malfunction. Please keep the display panel dry and clean.

*Non dispenser model - Type 2

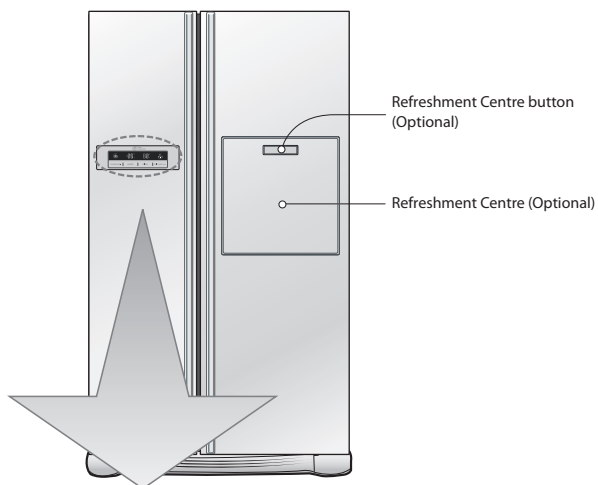

Function display board

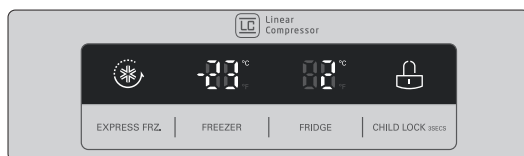

NOTE

- Your model may not include every option.
- The control display is touch operated. Excessive moisture on the display panel may result in its malfunction. Please keep the display panel dry and clean.

*Dispenser model - Type 1

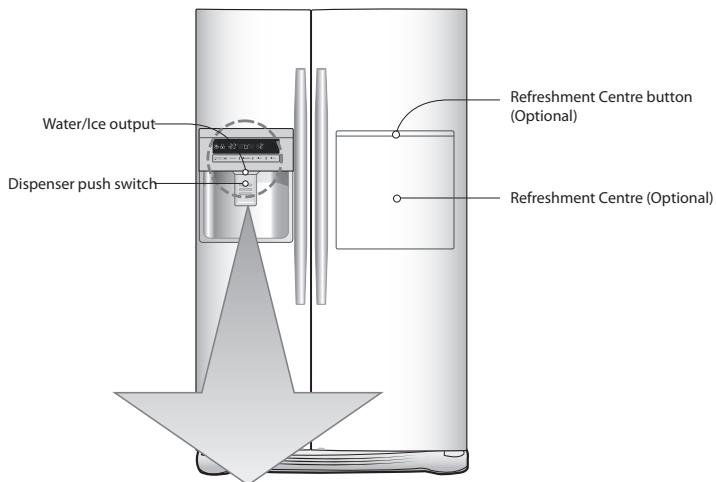

Option	Function display board
Type-1	<p>EXPRESS FRZ. FREEZER DISPENSER FRIDGE FILTER</p>
Type-2	<p>EXPRESS FRZ. FREEZER DISPENSER FRIDGE NO PLUMBING</p>

NOTE

- Your model may not include every option.
- The control display is touch operated. Excessive moisture on the display panel may result in its malfunction. Please keep the display panel dry and clean.

*Dispenser model - Type 2

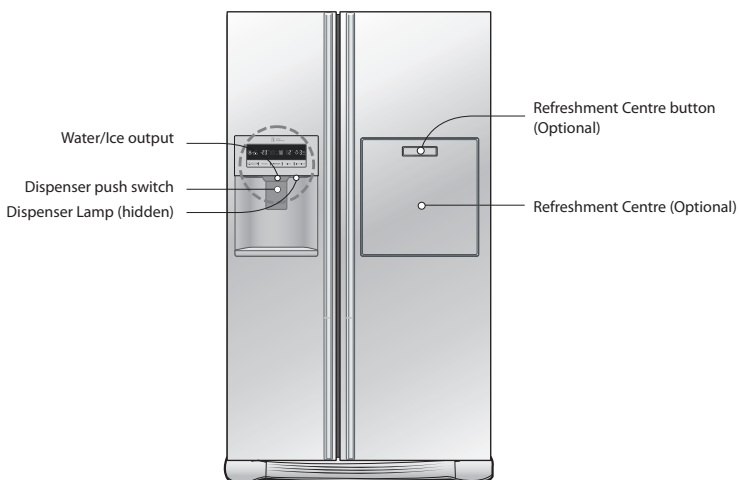

Option	Function display board
Type-1	<p>Linear Compressor</p> <p>EXPRESS FRZ. CHILD LOCK (LOCK) FREEZER DISPENSER FRIDGE LIGHT/FILTER</p>
Type-2	<p>Linear Compressor</p> <p>EXPRESS FRZ. CHILD LOCK (LOCK) FREEZER DISPENSER FRIDGE LIGHT/NO PLUMBING</p>

NOTE

- Your model may not include every option.
- The control display is touch operated. Excessive moisture on the display panel may result in its malfunction. Please keep the display panel dry and clean.

*Dispenser model - Type 3

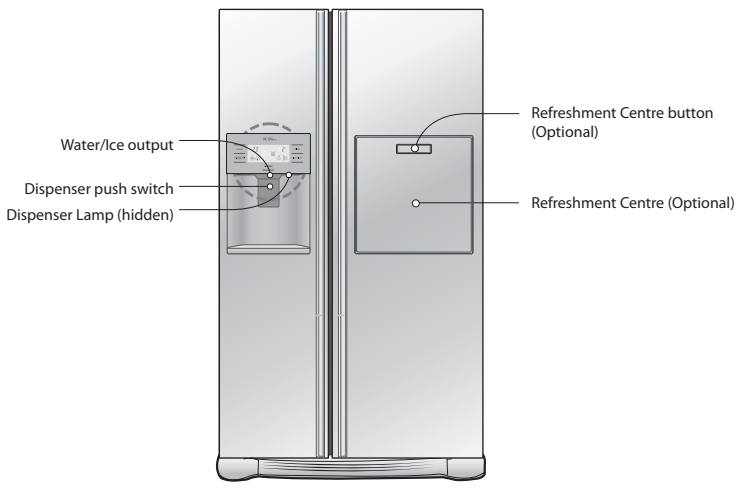

Option	Function display board
Type-1	<p>The Type-1 function display board features a central LCD screen. At the top, it displays 'Linear Compressor'. The screen shows the freezer temperature as -23°C and the fridge temperature as 8°C. Below the temperatures are icons for water and ice dispensing, and a 'DISPENSER' indicator. On the left side, there are labels for 'FREEZER' and 'EXPRESS FRZ. CHILD LOCK (ON/OFF)'. On the right side, there are labels for 'FRIDGE' and 'LIGHT/FILTER'. At the bottom, there is a 'DISPENSER' label.</p>
Type-2	<p>The Type-2 function display board is similar to the Type-1 model. It features a central LCD screen with 'Linear Compressor' at the top. The screen shows the freezer temperature as -23°C and the fridge temperature as 8°C. Below the temperatures are icons for water and ice dispensing, and a 'DISPENSER' indicator. On the left side, there are labels for 'FREEZER' and 'EXPRESS FRZ. CHILD LOCK (ON/OFF)'. On the right side, there are labels for 'FRIDGE' and 'LIGHT NO PLUMBING'. At the bottom, there is a 'DISPENSER' label.</p>

NOTE

- Your model may not include every option.
- The control display is touch operated. Excessive moisture on the display panel may result in its malfunction. Please keep the display panel dry and clean.

How to adjust the temperature in the freezer compartment

How to adjust the temperature in the refrigerator compartment

Display Power Saving Mode

This function is automatically activated after 20 seconds from the power is on. During Power Saving Mode all LED/LCDs display will remain off until the next time the door is opened. Then, it will come on whenever a door is opened or a button is pressed and remain on for 20 seconds after the last door opening or button selection.

You can adjust temperature of the fridge and freezer compartments

Freezer Compartment temperature adjustment

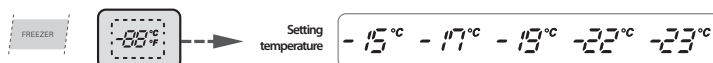

Refrigerator Compartment temperature adjustment



*Whenever pressing button, setting is repeated in the order of (Middle Strong)→(Middle)→(Weak)→(Middle Weak).

- The actual inner temperature varies depending on the food status. The indicated temperature is a target temperature, not the actual temperature within the refrigerator
- Until your refrigerator has settled from transit, it will not perform at its optimum. It takes 2 or 3 days for the fridge to stabilise. During this period, please adjust the temperature as above.

**Dispenser use
(on some
model)**

- Choose from crushed ice, water, and cubed ice and depress the dispenser switch with a glass or other container.

<p>Crushed Ice Select crushed ice by pressing the selection button, which will be highlighted.</p>	<p>Water Select water by pressing the selection button, which will be highlighted.</p>	<p>Cubed Ice Select cubed ice by pressing the selection button, which will be highlighted</p>
---	---	--



NB : Please wait for 2-3 seconds before removing the cup from beneath the dispenser to ensure it has finished dispensing the ice or water.

**Door mounted
automatic
icemaker
(on some model)**

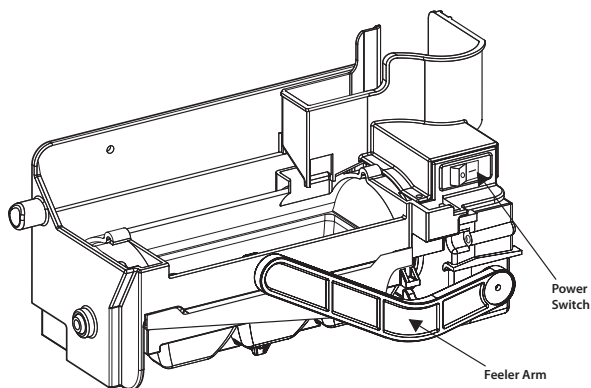

- The icemaker automatically makes 6 cubes of ice at any one time, which equals approximately 50-60 cubes per day. These quantities, however, may vary according to climatic conditions. E.g. the duration and amount of times the refrigerator door is opened.
- Icemaking stops when the ice storage bin is full.
- If you don't want to use the automatic icemaker, turn the icemaker switch to OFF. If you want to use automatic icemaker again, change the switch to ON.

NOTE

- The sound produced when the ice drops into the ice storage bin is normal, and is not caused by a defect.

WARNING

- Do not put your hands into the Ice maker during operation. You may injure yourself.
- Do not store ice (cubes) for longer than two weeks., they can cause the dispenser to malfunction as the ice cubes clump together.

Precautions when using the dispenser (on some model)

To get cold water

The dispensed water will not be icy cold, but just cool or cold. If you want colder water, dispense ice before dispensing water.

If you have difficulty in replacing the ice storage bin

Rotate the rotary gear in 1/4 cycle as shown in the illustration and then push it back.

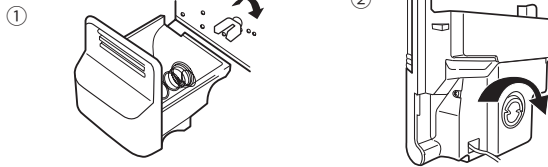

NOTE

- Figure ① and ② depends on model.

When the ice dispenser will not operate properly

It is normal that the ice maker will not operate correctly when there is only a small amount of ice left in the storage bin. Allow approximately one day for the ice maker to restock.

If the ice forms into a solid lump and interrupts the operation of the automatic ice maker mechanism, remove the ice storage bin, separate the ice, discard the inseparable ice, and put the usable ice pieces back into the bin. The intermittent dispensing of ice is normal. However, since ice may get stuck and block the ice chute, regularly check the ice chute and clear any obstacles.

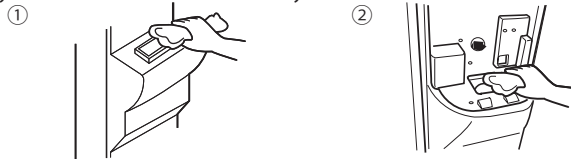

NOTE

- Figure ① and ② depends on model.

WARNING

- Never insert your hand or any other object into the ice chute as this may damage dispenser parts or cause injury to the hand.
- If ice is discoloured, stop using the dispenser and call the service centre.
- Do not touch the blade ① ③ as it may injure the hand.
- Never insert your hands into the ice maker during operation. It may cause injury ②.
- Do not allow your children to hang off the ice dispenser or the ice storage bin. This could cause injury.

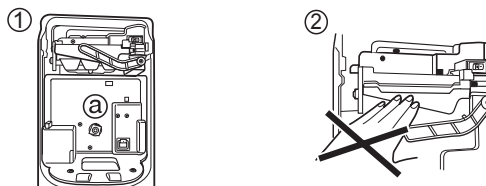

When ice maker does not operate smoothly

Ice is lumped together

- When ice is lumped together, take the ice lumps out of the ice storage bin, break them into small pieces, and place them back into the ice storage bin.
- When the ice maker produces small or lumped together ice, the amount of water supplied to the ice maker may need to be adjusted. Contact the service centre.
- * If ice is not used frequently, it may lump together.

Power failure

- Ice may melt and drop into the freezer compartment. Take the ice storage bin out and discard all the ice then dry it and place it back. After the machine is powered again, crushed ice will be automatically selected.

The unit is newly installed

- It takes about 12 hours for a newly installed refrigerator to make ice in the freezer compartment.

Express Freezer

Please select this function for fast freezing.

- OFF→ON→OFF is repeated whenever pressing  button.
- The arrow graphic remains On after flickering 4 times when selecting Express Freeze
- Express Freeze will automatically turn off after a fixed time passes.



Lock

This button locks the other buttons

- Locking or Release is repeated whenever the  is pressed for more than 3 seconds.
- If you use the lock button, none of the other buttons will work until you unlock them.

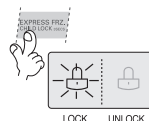

Filter condition (filter replacement cycle) display function (on some model)

- There is a replacement indicator light for the water filter cartridge on the dispenser.
- The water filter should be replaced every six months.
- The filter light comes on as a reminder to let you know when to replace filter.
- After replacing the filter, press and hold the filter button for more than 3 seconds to reset the indicator.

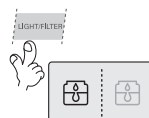

Dispenser light (on some model)

This button turn the dispenser light on and off.

- The dispenser light function is turned ON or OFF by pressing Light/Filter / Light button.

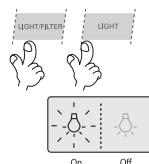

- For some models, icon  is always ON, except Display Power Saving Mode.



The other functions

Door open warning

- A warning bleep will sound 3 times every 30 seconds if the main or minibar door is left open or ajar for more than a minute.
- Please contact your local service centre if the warning continues to sound when the door is closed.

Diagnosis (failure detection) function

- The Diagnosis function automatically detects the problem when a failure is found whilst using of refrigerator.
- If a fault occurs, and none of the refrigerator buttons or functions are working, do not turn power off but immediately contact your local service centre. Once powered off it may not be possible for a service engineer to use the Diagnosis function to detect what caused the original fault.

How ice/cold water is supplied

Water is cooled while stored in the water tank in the refrigerator compartment, and then sent to the dispenser. Ice is made in the automatic ice maker and is then sent to the dispenser as either crushed or cubed ice.

NOTE

- It is normal that at first the water is not very cold. If you want colder water, add ice to the glass.

Throw away the first ice (about 20 pieces) and the first water (about 7 glasses) passing through the appliance when the refrigerator is initially installed.

The first ice and water may include particles or odour from the feed water pipe or the feed water box. This should also be done if the refrigerator has not been used for a long time.

Keep children away from the dispenser.

Children may push the dispenser switch incorrectly, or damage the dispenser by breaking associated parts. It may also cause them injury.

Always ensure that food does not block the ice chute.

If foods are placed at the entrance of the ice chute, ice may not be dispensed. The ice chute may become covered with ice powder if crushed ice is most commonly used. Remove the accumulated ice powder.

Never store beverage cans or other foods in the ice storage bin for rapid cooling.

This may damage the automatic ice maker.

Never use fine crystal glasses or crockery to collect ice.

Such glasses or containers may be broken.

Put ice into a glass before filling with water or other beverages.

Water may be splashed if ice is added after the drink.

Never touch the ice outlet either with hands or any implement.

Touching the ice outlet may cause a breakage or hand injury.

Never remove the ice maker cover. It might be necessary from time to time to level the ice so the storage bin can fill to capacity.

If ice is allowed to pile up near the ice maker, the ice maker may think that it is already full and it will stop producing ice.

If discolored ice is dispensed, stop using the appliance and contact your service centre immediately.

Ice may be jammed in ice chute causing the refrigerator to fail.

Never use narrow or deep glassware when using the icemaker

as ice can back up into the ice chute and cause a malfunction.

Keep the glass at a proper distance from ice outlet.

A glass too close to the outlet may hinder ice from coming out.

Freezer basket
(two stars section)

How to use

Use the minibar door as a stand

Never remove
the inner minibar
door cover

Never place
heavy items on
the minibar door
or allow children
to hang or sit
on it.

Two stars section ** (Applicable to some models only)

- Two stars means the temperature in the section is $-12^{\circ}\text{C} \sim -18^{\circ}\text{C}$.
- Freezer foods for short-term storage.

Refreshment centre (Applicable to some models only)

Open the minibar door.

- You can access the minibar without opening the refrigerator door, thus saving electricity.
- Inner lamp is lit in the refrigerator compartment when the minibar door opens, making it easy to identify the contents.

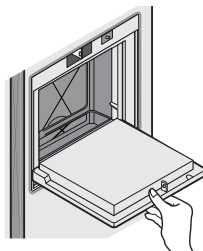

- Never use the minibar door as a chopping board and take care not to damage it with sharp tools.
- Never rest or press on the open minibar door.

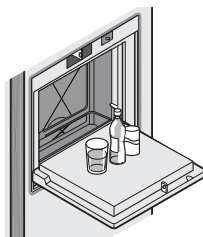

- The minibar can not function correctly without the cover. Only applies to models with inner minibar cover.



- Not only may the minibar door be damaged, but children may be hurt.

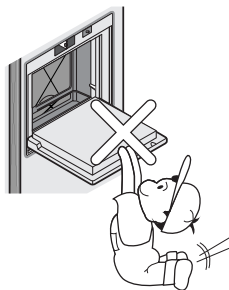

The other functions

No Plumbing Ice & Water (Applicable to some models only)

You can use the water in the water tank or general water bottles to use the Auto Ice Maker function and Water Dispenser function without having to connect the water pipe to the refrigerator.

Turn the secure switch into "OPEN" position as shown in ①. Next to loosen the water tank hold and pull the cap of the water tank ② to loosen the water tank.

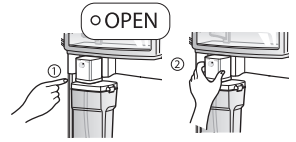

To fill the water tank

Lift up the clamps on both sides to open the water tank cover, and then fill the tank. Pour water up to the marked line (3ℓ or 2.1ℓ <depends of type>). When the tank is full, close the tank cover and lock the clamps on both sides.

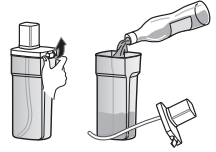

Adjust the top of the water tank cap and align the pump tube with the centre, pushing the tank in firmly, as shown in ③. Turn the security switch to the "CLOSE" position ④.

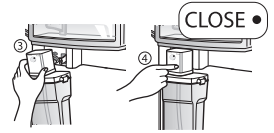

When using the water bottle

When using the water bottle

You can connect the cap to the general water bottle to use the water bottle, instead of the water tank provided. Turn the cap of the water tank in Open direction to open it. Open the water bottle and connect the cap. Only the water bottle of 1.5 ~2.0ℓ (35cm) can be used and there are some types that are not compatible.

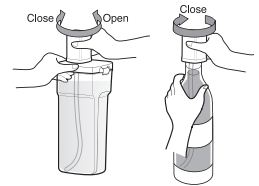

NOTE

- When assembling or disassembling the water tank, be careful not to apply excessive force as it can damage the water tank.
- If there is no water in the water tank, you will not be able to use the Auto Ice Maker function and Water Dispenser function.
- Using other liquid besides water can cause problems to the pump.
- When the water in the water tank is low, the size of the ice cubes may become smaller.
- It's a good idea to clean out the water tank initially before filling it with water and placing it into position.
- The method of using the Dispenser and Ice Maker is the same as other common Dispenser models.
- When using the water bottle instead of the water tank, do not throw away the water tank.
- Because the water tank can get heavy, don't let children use or hold the water tank, especially with one hand.
- You may hear the water pump operating 9~10 times per day.

Folding Shelf

Shelf (Applicable to some models only)

You can store taller items such as a gallon container or bottles by simply pushing in front half of shelf underneath back half of shelf. Pull toward you to return to a full shelf.

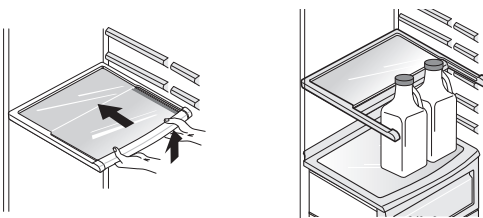

Wine holder adjustment
(Type 1)

Wine holder (Applicable to some models only)

Bottles can be stored laterally with this wine corner. This can be attached to any shelf.

In case of inserting the wine holder :

Pull the wine holder downward as in ② after inserting it into the side anchoring part of the shelf as in ① by catching it upward as in ①.

In case of separating the wine holder :

Pull the wine holder inward as in ③ after holding it upward as in ④ by catching it.

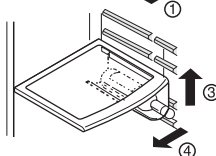
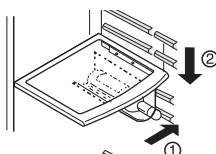
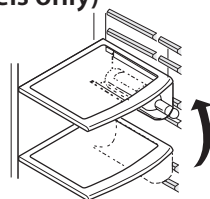

(Type 2)

Bottles can be stored laterally with this wine rack.

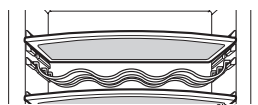

Egg box (Depends on model)

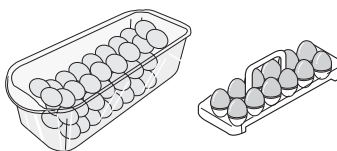

NOTE

- Never use the egg box as an ice storage bin. It can be broken.
- Never store the egg box in the freezer compartment or fresh compartment.

Humidity control in the vegetable compartment (Applicable to some models only)

The humidity can be controlled by adjusting the humidity control switch to the left/right when storing vegetables or fruits.

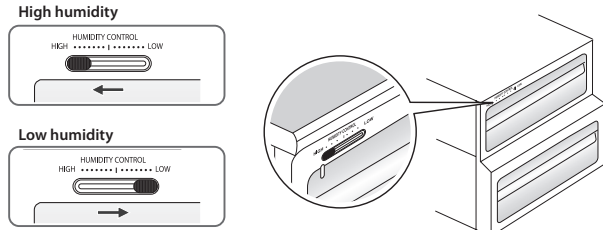

Deodorizer (Applicable to some models only)

This system efficiently absorbs strong odours by using an optical catalyst. This system does not have any affect on stored food.

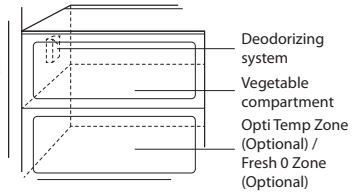

- The deodorizer is located behind the vegetable compartment. It can be removed for cleaning with soapy warm water from time to time.
- Please use closed containers to store pungent food. Odours are easily absorbed by other food in the compartment.

V Fresh (Option not available for all models)

Regular application of the V Fresh button keeps vegetables and fruits fresher. A portion of air is pumped out temporarily from the compartment which creates in the partially sealed compartment drawer a finite vacuum.

- Pressing the button on the drawer will evacuate air out of the compartment, thus temporarily reducing the internal air pressure.
- To open the drawer, ① grasp the release handle and press outwards and ② pull open the drawer. To close the drawer, push the drawer inwards until you hear a click. Then apply V Fresh button.

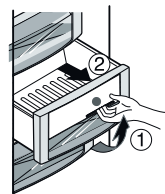

How to use the deodorizing system

Instructions for use

Fresh 0 Zone (Applicable to some models only)

- "Fresh 0 Zone" temperature can be changed by setting listed like below:
- When the refrigerator room is set on 6°C, FRESH 0 ZONE has 4 ±2°C.
- When the refrigerator room is set on 3°C, FRESH 0 ZONE has 0 ±2°C.
- When the refrigerator room is set on 0°C, FRESH 0 ZONE has -3 ±2°C.

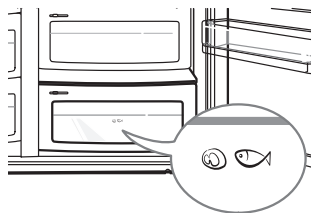

NOTE

- Store only meat, fish.
- If store vegetables and fruits, they can be frozen.

Using door rack (option)

If the ice maker is not used more room is available for foodstuffs.

- Disassemble and empty the automatic ice maker.
- Turn off the ice maker (①)
- Assemble the door rack with care.

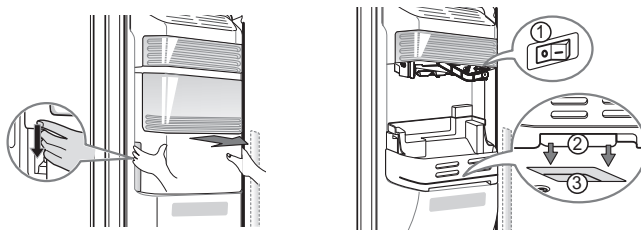

- Insert ② into bottom hole (③)
- Store food products in a way preventing them from falling out while opening the door.

Freezer Compartment (Option not available for all models)

If a large quantity of food is to be placed in the freezer compartment:

The middle drawer of freezer compartment shall be taken out of the appliance and food shall be stacked directly on the wire shelf.

Freezer compartment provides wire shelf on default to maximize food storage capacity. And also the drawer is provided to convenient usage for watery meat or half-liquid state food.

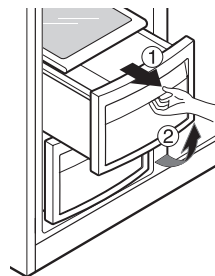

Opti Temp Zone Temperature Transition Corner (Applicable to some models only)

By pressing the button, store vegetables, fruits or other types of food such as defrosting meat, raw fish, etc.



Method to use

Temperature Change at Opti Temp Zone (Applicable to some models only)

You can select optimum temperature range depending on types of foods stored.

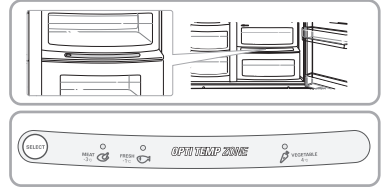

- 3-step of temperature selection including -3°C, -1°C and 4°C is available. Vegetables/fruits and cold storage foods requiring humidity maintenance and meats/fishes can be more freshly stored.

- When using the Opti Temp Zone as storage room of meats, storing vegetables or fruits, undesirable freezing may occur to some items if the incorrect setting is selected. It is recommended that all meat and produce be stored in plastic or paper bags.
- The Opti Temp Zone is for temporary storage only(1~2 days). Longer storage of Meat and Fish should be stored in the freezer to avoid it from spoiling.
- If opening the R-room, the lamp turns on and then turns off again on closing.
- (Vegetable/Fruit)→(Cold storage while maintaining humidity)→(Meat) is sequentially repeated whenever pressing the "SELECT" button.

When removing OptiTemp Zone

Opti Temp Zone Temperature Transition Corner (Applicable to some models only)

- First, remove the vegetable bin.
- After lifting the Opti Temp Zone case slightly ①, reach inside and pull it outward ②.

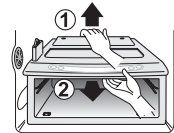





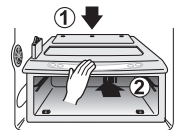





When installing OptiTemp Zone

- Fit the Opti Temp Zone case on to the ledge ① and gently slide it in ②.
- When forced, the connecting parts can be damaged.

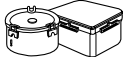

Location of foods

(Refer to identification of parts)

Wine holder	Store wine.	
Snack drawer	Store small foods such as bread, snacks, etc..	
Freezer compartment shelf	Store various frozen foods such as meat, fish, ice cream, frozen snacks, etc..	
Freezer compartment door rack	<ul style="list-style-type: none"> ▪ Store small packed frozen food. ▪ Temperature is likely to increase as door opens. So, do not store long-term food such as ice cream, etc.. 	
Freezer compartment drawer	<ul style="list-style-type: none"> ▪ Store meat, fish, chicken, etc.. after wrapping them with tin foil. ▪ Store dry. 	
Milk product corner	Store milk products such as butter, cheese, etc..	
Egg box	Place this egg box in the proper location.	
Refreshment center	Store foods of frequent use such as beverage, etc..	
Refrigerator compartment shelf	Store side dishes or other foods at a proper distance.	
Refrigerator compartment door rack	Store small packed food or beverages such as milk, juice, beer, etc..	
Vegetable drawer	Store vegetables or fruits.	
Vegetable drawer/ meat drawer conversion corner	Store vegetable, fruits, meat to thaw, raw fish, etc.. setting the conversion switch as necessary. Be sure to check the conversion switch setting before storing foods.	

Storing foods

- Store fresh food in the refrigerator compartment. How food is frozen and thawed is an important factor in maintaining its freshness and flavour.
- Do not store food which goes bad easily at low temperatures, such as bananas, and melons.
- Allow hot food to cool prior to storing. Placing hot food in a refrigerator could spoil other food, and lead to higher energy consumption.
- When storing food, cover it with vinyl wrap or store in a container with a lid. This prevents moisture from evaporating, and helps food to keep its taste and nutrients.
- Do not block air vents with food. Smooth circulation of chilled air keeps refrigerator temperatures even.
- Do not open the door frequently. Opening the door lets warm air enter the refrigerator and causes temperatures to rise.
- Never keep too much food in the door rack as it may push against the inner racks so that the door cannot fully close.

Freezer Compartment

- Do not store bottles in the freezer compartment - they may break when frozen.
- Do not refreeze food that has been thawed. This causes loss of taste and nutrients.
- When storing frozen food like ice cream for a long period, place it on the freezer shelf, not in the door rack.
- Do not touch cold foods or containers - especially metallic containers - with wet hands or place glass products in the freezer compartment.
- You may get chill blains, and glass containers may break when frozen, causing personal injury.

Refrigerator Compartment

- Avoid placing sauces on top refrigerator shelves, which could freeze on direct contact with chilled air.
- Always clean food prior to refrigeration. Vegetables and fruits should be washed and wiped, and packed food should be wiped, to prevent adjacent food from spoiling.
- When storing eggs in their storage rack or box, ensure that they are fresh, and always store them in an upright position, which keeps them fresh longer.

NOTE

- If you keeping the refrigerator in a hot and humid place, frequently open the door or store a lot of vegetables, dew may form. This has no effect on operation or performance. Remove the dew with an absorbent dry cloth.

Suggestion for energy saving

- Please do not keep the door open for a long time, close door in the shortest time.
- Storing too much food is not recommended. Sufficient space should be left to ensure proper air circulation.
- Do not set the temperature of fridge freezer lower than needed. Do not put food near the temperature sensors. Keep the distance of at least 5mm from the sensors.
- Allow hot food to cool prior to storing. Placing hot food in the fridge freezer could affect other food, and lead to higher energy consumption.
- Do not block air vents. Smooth circulation of cold air maintains the appropriate temperature.
- Do not open the door frequently. Opening the door lets warm air enter the fridge-freezer, and causes the temperature to rise.
- The configuration of shelves, baskets and drawers supplied by the manufacturer is the most efficient in terms of energy saving.

How to dismantle parts

NOTE

- Dismantle by reversing the assembly instructions. Be sure to unplug the power plug before dismantling and assembly. Never apply severe force to dismantle parts. Parts may be damaged.

Freezer compartment lamp

Separate the lamp by pulling it out ③ while slightly pressing ① and rotating ② the lamp cover. Turn the bulb counterclockwise.

OPTION 1 Use a 40-watt bulb(max.) which can be purchased at a service centre.

OPTION 2 - LED Use only 12VDC LED bulb which can be purchased at a service centre.

OPTION 1 To remove the lamp cover, press the protrusion under the lamp cover to the front and then pull the lamp cover out.

Turn the bulb counterclockwise. Max. 40 W bulb for refrigerator is used and can be purchased at a service centre.

OPTION 2 - LED To replace refrigerator light panel please contact to your service centre.

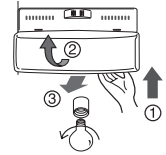

Refrigerator compartment lamp

NOTE

- Not all bulbs will fit your refrigerator.
- Be sure to replace the bulb with one of the same size, shape and wattage.
- The dispenser lights are LEDs that can not be changed.

Freezer compartment shelf

To remove a shelf, push the shelf to the left ②, lift the left part of the shelf a bit ①, lift the right part up ③, and take it out.

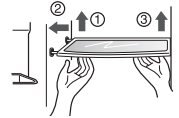

Door rack and support

Lift the door rack holding both sides ① and pull it out ②.

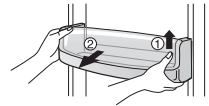

Ice storage bin (Applicable to some models only)

Hold the ice storage bin as shown in the right figure and pull it out ② while slightly lifting it ①.

- Do not dismantle the ice storage bin unless it is necessary.
- Use both hands to remove the ice bin to avoid dropping it.

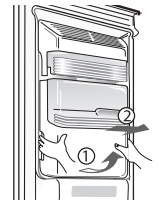

After dispenser is used (Applicable to some models only)

The water collector has no self-draining function. It should be cleaned regularly.

First take out the water collector cover.

Press the cover where PUSH marked ① to lift the water collector cover up.

Take out the water collector cover as illustrated ②.

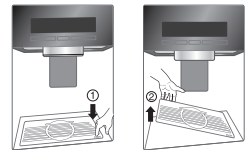

Refreshment centre
(Applicable to some models only)

- Separate the bin ① to upward.
- Separate the upper rack of the minibar and then pull out the minibar cover ②.
- The minibar can be removed by pulling it upwards.

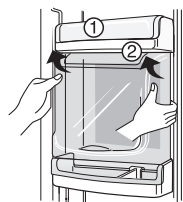

NOTE

- Be sure to remove parts from the refrigerator door when removing the vegetable compartment, snack drawer and minibar cover.

Vegetable compartment cover

- To remove the vegetable compartment cover, pull out the vegetable compartment a bit to the front ①, lift the front part of the vegetable compartment cover as shown by ②, and take it out.

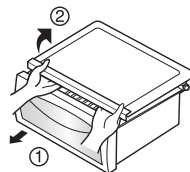

V Fresh
(Option not available for all models)

To remove the vegetable compartment drawer, pull out the drawer halfway and then ① lift the roof of the outer compartment while ② pulling out the drawer.

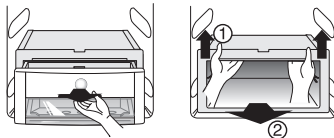

Space Plus
(Applicable to some models only)

Lift the space plus ① and pull it out to ② direction.

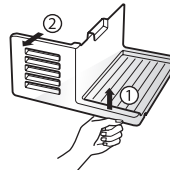

Ice storage bin
(Applicable to some models only)

- Hold the ice storage bin as shown in the right figure and pull it out ② while slightly lifting it ①.
- It is recommended that the ice storage bin is not dismantled unless absolutely necessary.
- Be sure to use both hands when removing the ice storage bin, so as not to drop it on the floor.
- If the ice storage bin does not fit well, slightly rotate the rotating device.

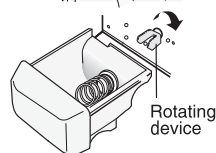

Ice maker
(Applicable to some models only)

Turn off the Ice maker switch (off) after remove the SPACE PLUS, if you are on a long term vacation or don't use ice. If you want to use for ice, turn on the Ice maker switch(on).

General information

Vacation time

During average length vacations, you will probably find it best to leave the refrigerator in operation. Place freezable items in freezer for longer life. When you plan not to operate, remove all food, disconnect the power cord, clean the interior thoroughly, and leave each door OPEN to prevent odour formation.

Power failure

Most power failures that are corrected in an hour or two will not affect your refrigerator temperatures. However, you should minimize the number of door openings while the power is off.

If you move

Remove or securely fasten down all loose items inside the refrigerator. To avoid damaging the height adjusting screws, turn them all the way into the base.

Anti condensation pipe

The outside wall of the refrigerator cabinet may sometimes get warm, especially just after installation. Don't be alarmed. This is due to the anti-condensation pipe, which pumps through the refrigerator to prevent "sweating" on the outer cabinet wall.

Understanding sounds you may hear

Your new refrigerator may make sounds that your old one didn't make. Because the sounds are new to you, you might be concerned about them. Most of the new sounds are normal. Hard surfaces, like the floor, walls and cabinets, can make the sounds seem louder than they describes the kinds of actually are. The following sounds and what may be making them:

- The defrost timer will click when the automatic defrost cycle begins and ends. The thermostat control (or refrigerator control, depending on the model) will also click when cycling on and off.
- Rattling noises may come from the flow of refrigerant, the water line, or items stored on top of the refrigerator.
- Your refrigerator is designed to run more efficiently to keep your food items at the desired temperature. The high efficiency compressor may cause your new refrigerator to run longer than your old one, and you may hear a pulsating or high-pitched sound.
- You may hear the evaporator fan motor circulating the air through the refrigerator and freezer compartments.
- As each cycle ends, you may hear a gurgling sound due the refrigerant flowing in your refrigerator.
- Contraction cause a popping noise to and expansion of the inside walls may a popping noise.
- Water dripping on the defrost heater during a defrost cycle may cause a sizzling sound.
- You may hear air being forced over the condenser by the condenser fan.
- You may hear water running into the drain pan during the defrost cycle.

Cleaning

It is important that your refrigerator be kept clean to prevent undesirable odours. Spilled food should be wiped up immediately, since it may acidify and stain plastic surfaces if allowed to settle.

Exterior

Use a luke warm solution of mild soap or detergent to clean the durable finish of your refrigerator. Wipe with a clean damp cloth and then dry.

Interior

Regular cleaning is recommended. Wash all compartments with a baking soda solution or a mild detergent and warm water. Rinse and dry.

After cleaning

Please verify that the power cord is not damaged, power plug is not overheated, or power plug is well inserted into the wall outlet socket.

Warning

Always remove power cord from the wall outlet prior to cleaning near to electrical equipment (lamps, switches, controls, etc.). Wipe up excess moisture with a sponge or cloth to prevent water or liquid from getting into any electrical part and causing an electric shock. Never use metallic scouring pads, brushes, coarse abrasive cleaners, strong alkaline solutions, flammable or toxic cleaning liquids on any surface. Do not touch frozen surfaces with wet or damp hands, because damp object will stick to extremely cold surfaces.

Cleaning the water dispenser and the water tank. (Applicable to some models only)

Frequency of cleaning: every 2 months or when is needed.

Procedure:

1. Before cleaning pour out water from the water tank.
2. Mix 0.5l of water with proper amount of dispenser cleaning product (and then pour it into the water tank). Do not use any harsh chemicals.
3. Dispense 1 cup of solution and leave the rest of it inside dispenser system for time shown on the cleaning product label. Do not drink water from the dispenser while all the cleaning process!
4. Dispense rest of the solution until the tank is empty.
5. Clean the water tank with a soft sponge and rinse it under tap water.
6. Fill the water tank with fresh water. Dispense 3 cups of water, one after another with 20s breaks. Fill the water tank with boiled water and dispense one cup.
7. Check taste of water. If the taste is tainted repeat action no.6 until water has non-suspicious taste.

We recommend NOT to leave water inside the water tank for more than 2 days.

Occurrence	Possible cause	Solution
Sediment seen inside the water tank	Type of water supply or water dispenser needs cleaning.	Clean the water tank. Always boil water before placing it into the water tank.
Bad smell and taste of water	Water not dispensed for extended period.	Pour out old water. Clean the water tank. Fill the water tank with new water.

General information

Before calling for service, review this list. It may save you both time and expense. This list includes common occurrences that are not the result of defective workmanship or materials in this appliance.

Occurrence	Possible cause	Solution
Running of refrigerator	Refrigerator control is off.	Set refrigerator control. See setting the controls.
Refrigerator compressor does not run.	Refrigerator is in defrost cycle.	This is normal for a fully automatic defrosting refrigerator. The defrost cycle occurs periodically.
	Plug at wall outlet is disconnected.	Make sure plug is tightly pushed into outlet.
	Power outage. Check house lights.	Call your electricity supplier.
	Refrigerator is larger than the previous one you owned.	This is normal. Larger, more efficient units run longer in these conditions.
	Room or outside weather is hot.	It is normal for the refrigerator to work harder under these conditions.
Refrigerator compressor runs too often or too long.	Refrigerator has recently been disconnected for a period of time.	It takes some hours for the refrigerator to cool down completely.
	Large amounts of warm or hot food may have been stored recently.	Warm food will cause the refrigerator to run longer until the desired temperature is reached.
	Doors are opened too frequently or too long.	Warm air entering the refrigerator causes it to run longer. Open the door less often.
	Refrigerator or freezer door may be slightly open.	Make sure the refrigerator is level. It is normal for the refrigerator to have a slight lean backwards. Keep food and containers from blocking door. See problem section OPENING/CLOSING of doors.
	Refrigerator control is set too cold.	Set the refrigerator control to a warmer setting until the refrigerator temperature is satisfactory.
	Refrigerator or freezer gasket is dirty, worn, cracked, or poorly fitted.	Clean or change gasket. Leaks in the door seal will cause refrigerator to run longer in order to maintain desired temperatures.
	Thermostat is keeping the refrigerator at constant temperature.	This is normal. Refrigerator goes on and off to keep the temperature constant.

Occurrence	Possible cause	Solution
Refrigerator compressor does not run	Thermostat is keeping the refrigerator at a constant temperature.	Set refrigerator control. See setting the controls.
Temperatures are too cold		
Temperature in the freezer is too cold but refrigerator temperature is satisfactory.	Freezer control is set too cold	Set freezer control to a warmer setting until the freezer temperature is satisfactory.
Temperature in the refrigerator is too cold but freezer temperature is satisfactory.	Refrigerator control is set too cold	Set refrigerator control to a warmer setting until the refrigerator temperature is satisfactory.
Food stored in drawers freezes.	Refrigerator control is set too cold	See above solution.
Meat stored in fresh meat drawer freezes.	Meat should be stored at a temperature just below the freezing point of water (32F, 0°C) for maximum fresh storage time.	It is normal for ice crystals to form due to the moisture content of meat.
Temperatures are too warm		
Temperatures in the refrigerator or freezer are too warm.	Freezer control is set too warm.	Set the refrigerator control to a colder setting until the freezer or refrigerator temperature is satisfactory.
	Refrigerator control is set too warm. Refrigerator control has some effect on freezer temperature.	Set the refrigerator control to a colder setting until the freezer or refrigerator temperature is satisfactory.
	Doors are opened too frequently or too long.	Warm air enters the refrigerator/ freezer whenever the door is opened. Open the door less often.
	Door is slightly open.	Close the door completely
	Large amounts of warm or hot food may have been stored recently.	Wait until the refrigerator or freezer has a chance to reach its selected temperature.
	Refrigerator has recently been disconnected for a period of time.	A refrigerator requires some hours to cool down completely. Do not place food items inside the refrigerator until it has initially reached its set temperature, or has cooled down considerably.
Temperature in the refrigerator is too warm but the freezer temperature is satisfactory.	Refrigerator control is set too warm.	Set the refrigerator control to a colder setting.

Occurrence	Possible cause	Solution
Sound and noise		
Louder sound levels when refrigerator is on.	Today's refrigerators have increased storage capacity and maintain more even temperatures.	It is normal for sound levels to be higher.
Louder sound levels when compressor comes on.	Refrigerator operates at higher pressures during the start of the ON cycle.	This is normal. The sound will level off as the refrigerator continues to run.
Vibrating or rattling noise.	Floor is uneven or weak. Refrigerator rocks on the floor when it is moved slightly.	Be sure floor is level and solid and can adequately support refrigerator.
	Refrigerator control is set too cold	See above solution.
	Items placed on the top of the refrigerator are vibrating.	Remove items.
	Dishes are vibrating on the shelves in the refrigerator.	It is normal for dishes to vibrate slightly. Move dishes slightly. Make sure refrigerator is level and firmly set on floor. It is normal for the refrigerator to have a slight lean backwards.
	Refrigerator is touching wall or cabinets.	Move refrigerator so that it does not touch the wall or refrigerator.
Water/Moisture/Ice inside refrigerator		
Moisture collects on the inside walls of the refrigerator.	The weather is hot and humid which increases the rate of frost buildup and internal sweating.	This is normal.
	Door is slightly open.	See problem section opening/closing of doors.
	Door is opened too often or too long.	Open the door less often.
Water/Moisture/Ice outside refrigerator		
Moisture forms on the outside of the refrigerator or between doors.	Weather is humid.	This is normal in humid weather. When humidity is lower, the moisture should disappear.
	Door is slightly open, causing cold air from the inside the refrigerator to meet warm air from the outside.	This time, close the door completely.

Occurrence	Possible cause	Solution
Odours in refrigerator	Interior needs to be cleaned.	Clean interior with sponge,warm water and baking soda.
	Food with strong odour is in the refrigerator.	Cover food completely.
	Some containers and wrapping materials produce odours.	Use a different container or brand of wrapping materials.
Opening/Closing of doors/Drawers		
Door(s) will not close.	Food package is keeping door open.	Move packages that keep door from closing.
	Door was closed too hard, causing other door to open slightly	Close both doors gently.
	Refrigerator is not level. It rocks on the floor when it is moved slightly.	Adjust the height adjusting screw.
	Floor is uneven or weak. Refrigerator rocks on the floor when it is moved slightly.	Be sure floor is level and can adequately support refrigerator. Contact carpenter to correct sagging or sloping floor. It is normal for the refrigerator to have a slight lean backwards.
	Refrigerator is touching wall or cabinets.	Move refrigerator.
Drawers are difficult to move.	Food is touching shelf on top of the drawer.	Keep less food in drawer.
	Track that drawer slides on is dirty.	Clean drawer and track.
Dispenser		
Dispenser will not dispense ice	Ice storage bin is empty.	When the first supply of ice is dropped into the bin, the dispenser should operate.
	Freezer temperature is set too warm.	Turn the freezer control to a higher setting so that ice cubes will be made. When the first supply of ice is made,the dispenser should operate.
	Household water line valve is not open.	Open household water line valve and allow sufficient time for ice to be made. When ice is made, dispenser should operate.
	Refrigerator or freezer door is not closed.	Be sure both doors are closed.

Occurrence	Possible cause	Solution
Dispenser will not dispense ice.	Ice has melted and frozen around auger due to infrequent use, temperature fluctuations and/or power outages.	Remove ice storage bin, and thaw and the contents. Clean bin, wipe dry and replace in proper position. When new ice is made, dispenser should operate.
Ice dispenser is jammed.	Ice cubes are jammed between the icemaker arm and back of the bin.	Remove the ice cubes that are jamming the dispenser.
	Ice cubes are frozen together.	Only the ice cubes made by the ice maker should be used with the dispenser.
	Ice cubes that have been purchased or made in some other way have been used in the dispenser.	Use a different container or brand of wrapping materials.
Dispenser will not dispense water.	Household water line valve is not open. See problem "Ice maker is not making any ice."	Open household water line valve.
	Refrigerator or freezer door is not closed.	Be sure both doors are closed.
Water has an odd taste and/or odour.	Water has been in the tank for too long.	Dispense and discard 7 glasses of water to freshen the supply. Dispense and discard an additional 7 glasses to completely rinse out tank.
	Unit not properly connected to cold water line.	Connect unit to cold water line which supplies water to kitchen tap.
Sound of ice dropping	This sound is normally made when automatically made ice is dropped into ice storage bin. Volume may vary according to refrigerator's location.	
Sound of water supply	This sound is normally made when ice maker is supplied with water after dropping the automatically made ice.	
The display shows the word OFF (After 20 seconds the word OFF disappears but the refrigerator is still in the DEMO MODE).	The refrigerator is in the Demo(Demonstration) Mode. The Demonstration Mode disables the cooling system, only the lighting system and the display operate in a regular way. To disable the Demo Mode open the door and holding down the Fridge button press the EXPRESS F button 3 times After deactivating the Demo Mode, the previously set values will appear.	
Other	Please thoroughly read 'Automatic ice maker and dispenser' in this manual.	

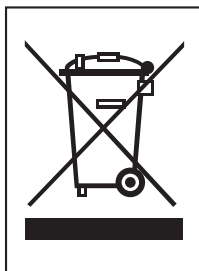

DISPOSAL OF YOUR OLD APPLIANCE

1. When this crossed-out wheeled bin symbol is attached to a product it means the product is covered by the European Directive 2002/96/EC.
2. All electrical and electronic products should be disposed of separately from the municipal waste stream via designated collection facilities appointed by the government or the local authorities.
3. The correct disposal of your old appliance will help prevent potential negative consequences for the environment and human health.
4. For more detailed information about disposal of your old appliance, please contact your local Council, waste disposal service or the shop where you purchased the product.

This product contains fluorinated greenhouse gases covered by the Kyoto Protocol (Optional).

• Information of fluorinated greenhouse gases used as refrigerant of this refrigerator.

Chemical name	Composition of Gases	Total GWP (kg CO ₂ -eq)
R-134a	100% HFC-134a	1300