



**LG**

Life's Good

ENGLISH

OWNER'S MANUAL

# MONITOR SIGNAGE

Please read this manual carefully before operating your set and retain it for future reference.

**MONITOR SIGNAGE MODELS**

55WV70MS

55WV70BS

# CONTENTS

## 4 LICENSES

---

## 5 ASSEMBLING AND PREPARING

---

- 5 Accessories
- 6 Parts
- 7 To install in a Portrait Layout
- 7 Remove L-brackets before Installation
- 8 STORAGE METHOD FOR PANEL PROTECTION
- 8 - Correct Method
- 8 - Incorrect Method
- 9 Installing on a wall
- 10 EXTERNAL EQUIPMENT SETUP
- 10 - IR RECEIVER
- 11 Tiling Displays
- 11 - How to Mount the Set
- 12 - How to Join Sets

## 13 REMOTE CONTROL

---

- 15 Displaying the device name connected to an input port

## 16 USING THE MONITOR SET

---

- 16 Connecting to a PC
- 16 - RGB connection
- 17 - DVI connection
- 17 - HDMI connection
- 18 - Display Port connection
- 18 - IR Receiver connection
- 19 Adjusting the screen
- 19 - Selecting an image mode
- 19 - Customizing image options
- 20 - Customizing PC display options
- 20 Adjusting the sound
- 20 - Selecting an sound mode

- 21 - Customizing sound options
- 21 Using additional options
- 21 - Adjusting aspect ratio
- 23 - Using the input list

## 24 ENTERTAINMENT

---

- 24 - Connecting to a wired network
- 25 - Network Status
- 26 - Connecting USB storage devices
- 27 - Browsing files
- 29 - Viewing movies
- 32 - Viewing photos
- 35 - Listening to music
- 37 - Viewing the Contents List
- 38 - DivX® VOD Guide
- 39 - Using PIP/PBP

## 40 CUSTOMIZING SETTINGS

---

- 40 Accessing the main menus
- 41 - PICTURE settings
- 44 - AUDIO settings
- 45 - TIME settings
- 46 - OPTION settings
- 51 Picture ID
- 52 - NETWORK settings

## 53 MAKING CONNECTIONS

---

- 54 Connecting to a HD receiver, DVD, Camcorder, Camera, Gaming Device or VCR player
- 54 - DVI connection
- 54 - HDMI connection
- 55 - Component connection
- 55 - AV(COMPOSITE,CVBS) connection
- 56 Connecting to the LAN
- 56 - LAN connection
- 56 Connecting to a USB
- 57 Daisy Chain Monitors

- 57 - RGB Cable
- 57 - DVI Cable

## **58 TROUBLESHOOTING**

---

## **61 SPECIFICATIONS**

---

## **63 IR CODES**

---

## **64 CONTROLLING THE MULTIPLE PRODUCT**

---

- 64 Connecting the cable
- 64 RS-232C Configurations
- 64 Communication Parameter
- 65 Command reference list
- 67 Transmission / Receiving protocol

# LICENSES

Supported licenses may differ by model. For more information of the licenses, visit [www.lg.com](http://www.lg.com).



HDMI, the HDMI logo and High-Definition Multimedia Interface are trademarks or registered trademarks of HDMI Licensing LLC.



**ABOUT DIVX VIDEO:** DivX® is a digital video format created by DivX, LLC, a subsidiary of Rovi Corporation. This is an official DivX Certified® device that plays DivX video. Visit [divx.com](http://divx.com) for more information and software tools to convert your files into DivX videos.

**ABOUT DIVX VIDEO-ON-DEMAND:** This DivX Certified® device must be registered in order to play purchased DivX Video-on-Demand (VOD) movies. To obtain your registration code, locate the DivX VOD section in your device setup menu. Go to [vod.divx.com](http://vod.divx.com) for more information on how to complete your registration.

DivX Certified® to play DivX® video up to HD 1080p, including premium content.

DivX®, DivX Certified® and associated logos are trademarks of Rovi Corporation or its subsidiaries and are used under license.

Covered by one or more of the following U.S. patents: 7,295,673; 7,460,668; 7,515,710; 7,519,274



Manufactured under license from Dolby Laboratories. “Dolby” and the double-D symbol are trademarks of Dolby Laboratories.



# ASSEMBLING AND PREPARING

## Accessories

Check your product box for the following items. If there are any missing accessories, contact the local dealer where you purchased your product. The illustrations in this manual may differ from the actual product and accessories.



**CD (Owner's Manual, SuperSign Elite-w Program/SuperSign Manual) / Card**

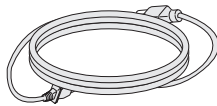

**Power Cord**

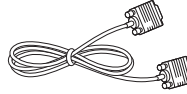

**RGB Cable**

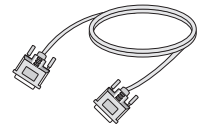

**DVI Cable**

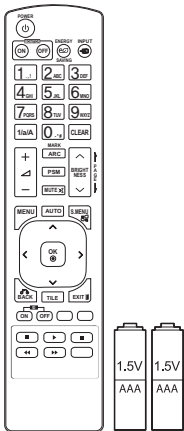

**Remote Control and Batteries**

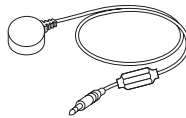

**IR Receiver**

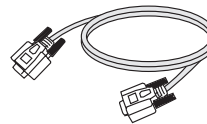

**RS-232C Cable**

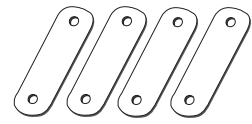

**Tiling Guide  
(4ea)**



**M4 x 6L  
Screws (8ea)**



**M6  
Screws (4ea)**



### CAUTION

- Do not use any pirated items to ensure the safety and product life span.
- Any damages or injuries by using pirated items are not covered by the warranty.



### NOTE

- The accessories supplied with your product may vary depending on the model.
- Product specifications or contents in this manual may be changed without prior notice due to upgrade of product functions.

# Parts

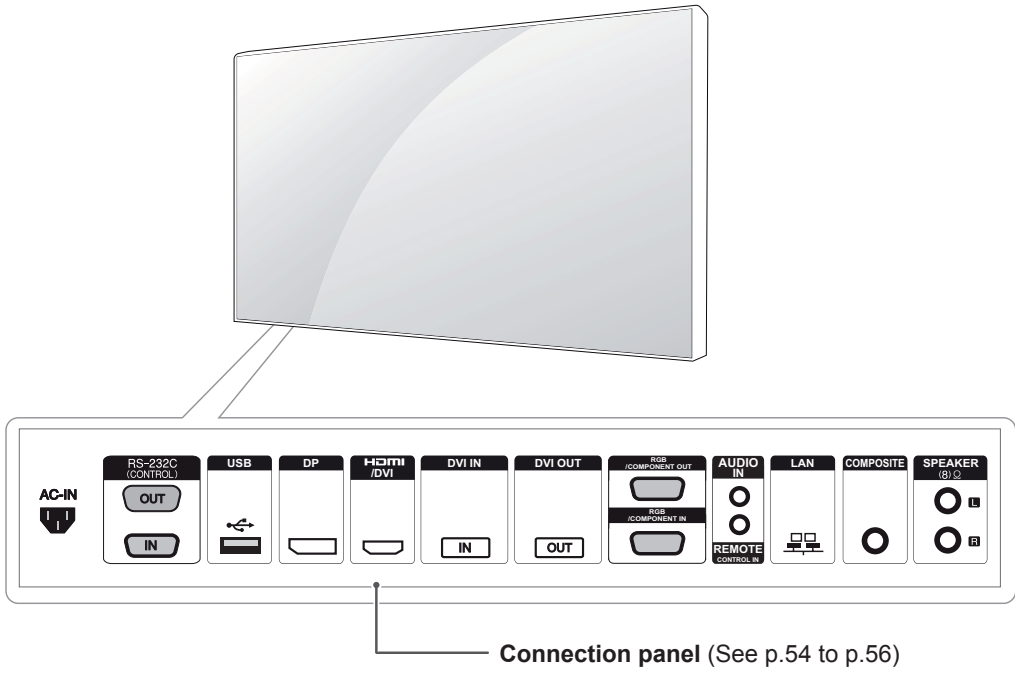

## To install in a Portrait Layout

When installing in a Portrait Layout, rotate the monitor clockwise 90 degrees (when facing the screen).

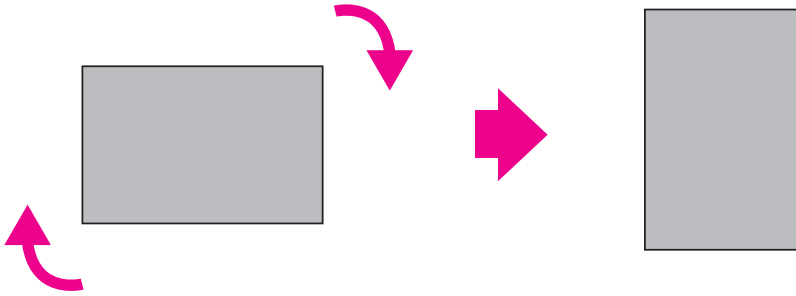

## Remove L-brackets before Installation

Remove the L-brackets from each corner of the monitor before installing it.

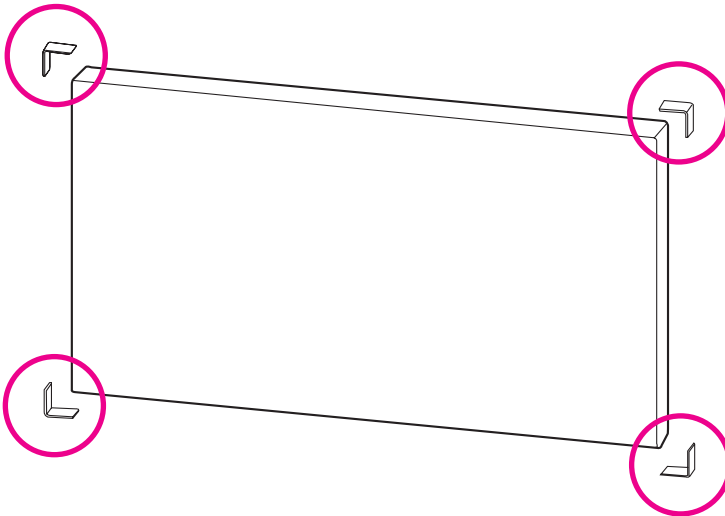

### ! NOTE

Keep the removed L-brackets and use them when moving the monitor later.

## STORAGE METHOD FOR PANEL PROTECTION

### Correct Method

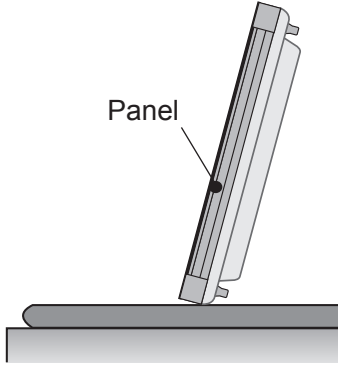

If the product needs to be set upright, hold both sides of the product, and tilt backward carefully for. Do not let the panel touch the floor.

### Incorrect Method

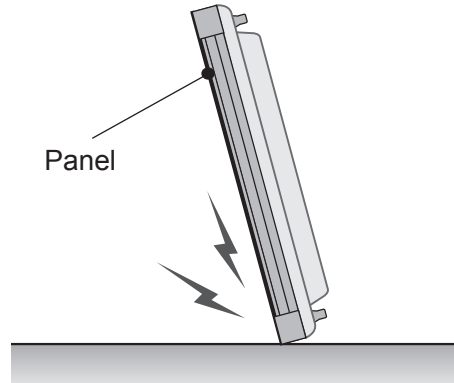

If the product is tilted onto the bezel, the bottom of the panel may be damaged.

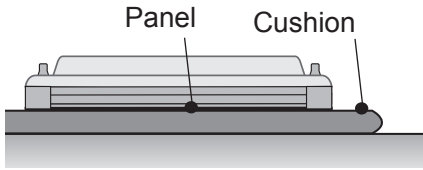

When laying down the product, lay a cushion on a flat floor. Put the product on it with the panel of the product facing down.

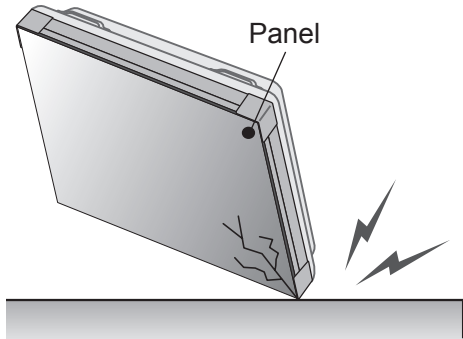

If the product is tilted onto the edge of the panel, the panel may be damaged.

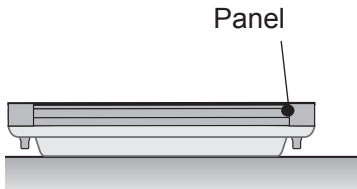

If there is not a cushion available, ensure the floor is clean and then lay the product down carefully with the panel facing either upward or downward. At this time, be careful for objects not to fall on the panel.

## Installing on a wall

To install the Monitor on a wall (optional), use the VESA screws provided as accessories to fasten it.

Please refer to p11 on How to Mount the Set.

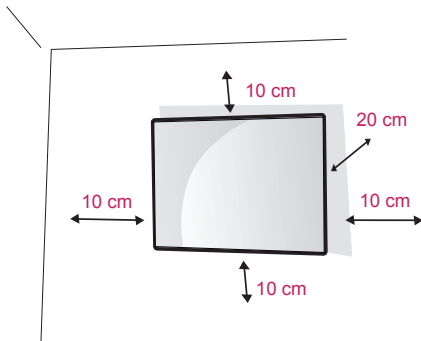

Install the monitor at least 10 cm away from the wall and leave about 10 cm of space at each side of the monitor to ensure sufficient ventilation.

Use the wall mount plate and screws that comply with the VESA standard.



### CAUTION

- Disconnect the power cord first, and then move or install the Monitor set. Otherwise electric shock may occur.
- If you install the Monitor set on a ceiling or slanted wall, it may fall and result in severe injury.
- Do not over tighten the screws as this may cause damage to the Monitor set and void your warranty.
- Use the screws and wall mounts that meet the VESA standard. Any damages or injuries by misuse or using an improper accessory are not covered by the warranty.

### NOTE

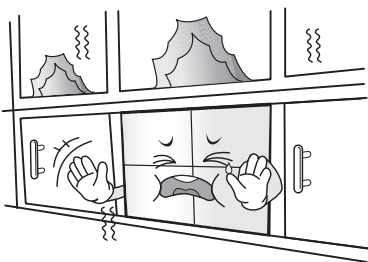

Do not install the product in a place with no ventilation (e.g., on a bookshelf or in a closet) or on a carpet or cushion. If there is no other option but to mount the product on the wall, make sure that sufficient ventilation is provided before installation.

- Failure to do so may result in a fire due to the increase in the internal temperature.

## EXTERNAL EQUIPMENT SETUP

ENGLISH

### IR RECEIVER

This allows a remote control sensor to be placed in a custom location. Then that display can control other displays via an RS-232 cable.

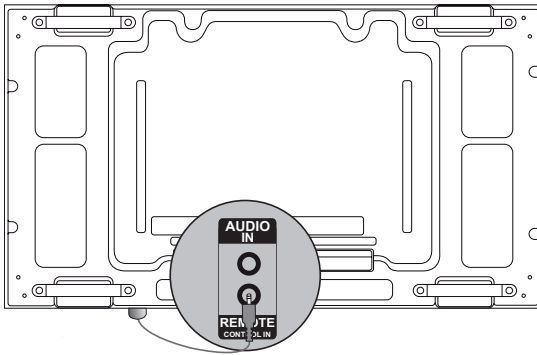

## Tiling Displays

### How to Mount the Set

#### \*Example of 2 x 2 tiling

\* Using the screws for attaching the VESA wall mount, mount the set to the wall mount plate or the wall.

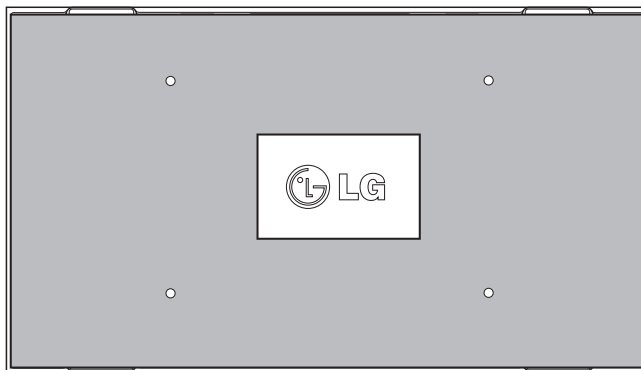
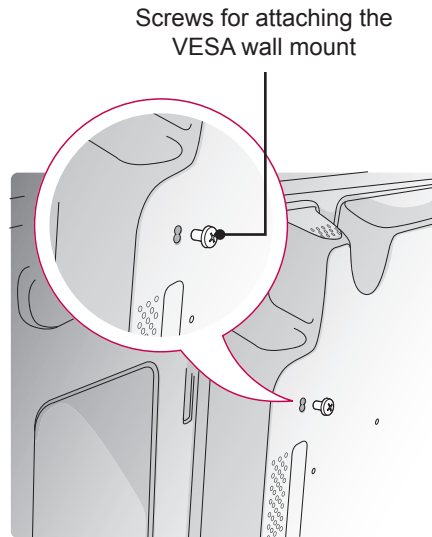

<Rear view of the set with the wall mount plate>

\* The wall mount plate is shaded in gray in the illustration to help you see it.

## How to Join Sets

- 1 Join other sets using screws for fixing the VESA wall mount in the same way as above.

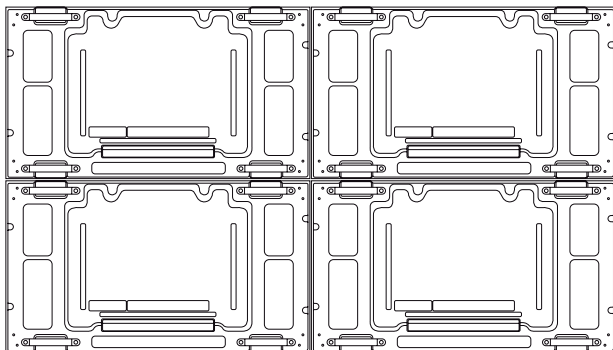

Set 4 joined to the rest of the sets  
(2 x 2 tiling)

- 2 After joining the sets, use the tiling guide to adjust the gap between the sets.

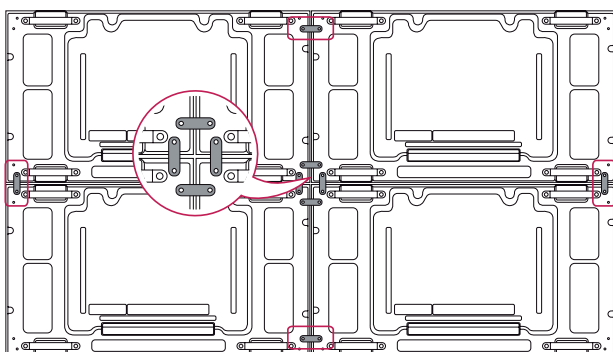

- 3 Now the 2 x 2 tiling is complete.  
You can tile in various combinations, such as 3 x 3.

### ! NOTE

- The load applied to each set should be supported by the wall mount plate or the wall using a VESA wall mount (600 x 400).
- The load applied to each set should be supported by the wall mount plate using a VESA wall mount. (Each set must be firmly mounted to the wall mount plate or the wall.)
- You may mount the set without using the tiling guide; this does not affect the performance of the device.



# REMOTE CONTROL

The descriptions in this manual are based on the buttons of the remote control. Please read this manual carefully and use the Monitor set correctly.

To replace batteries, open the battery cover, replace batteries (1.5 V AAA) matching ⊕ and ⊖ ends to the label inside the compartment, and close the battery cover.

To remove the batteries, perform the installation actions in reverse.

**CAUTION**

- Do not mix old and new batteries, as this may damage the remote control.
- Make sure to point the remote control to the remote control sensor on the Monitor set.

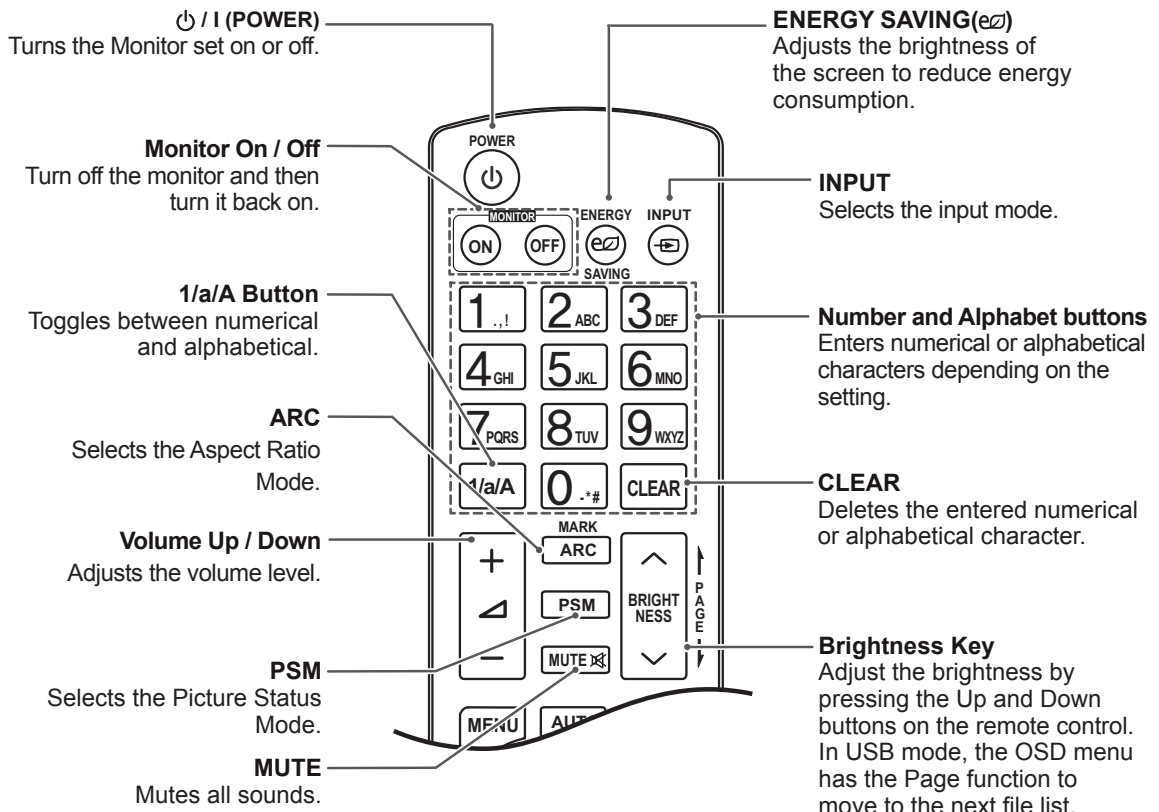
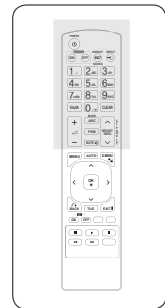
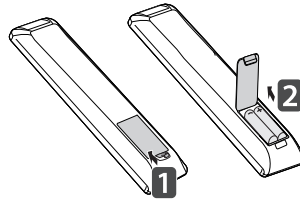

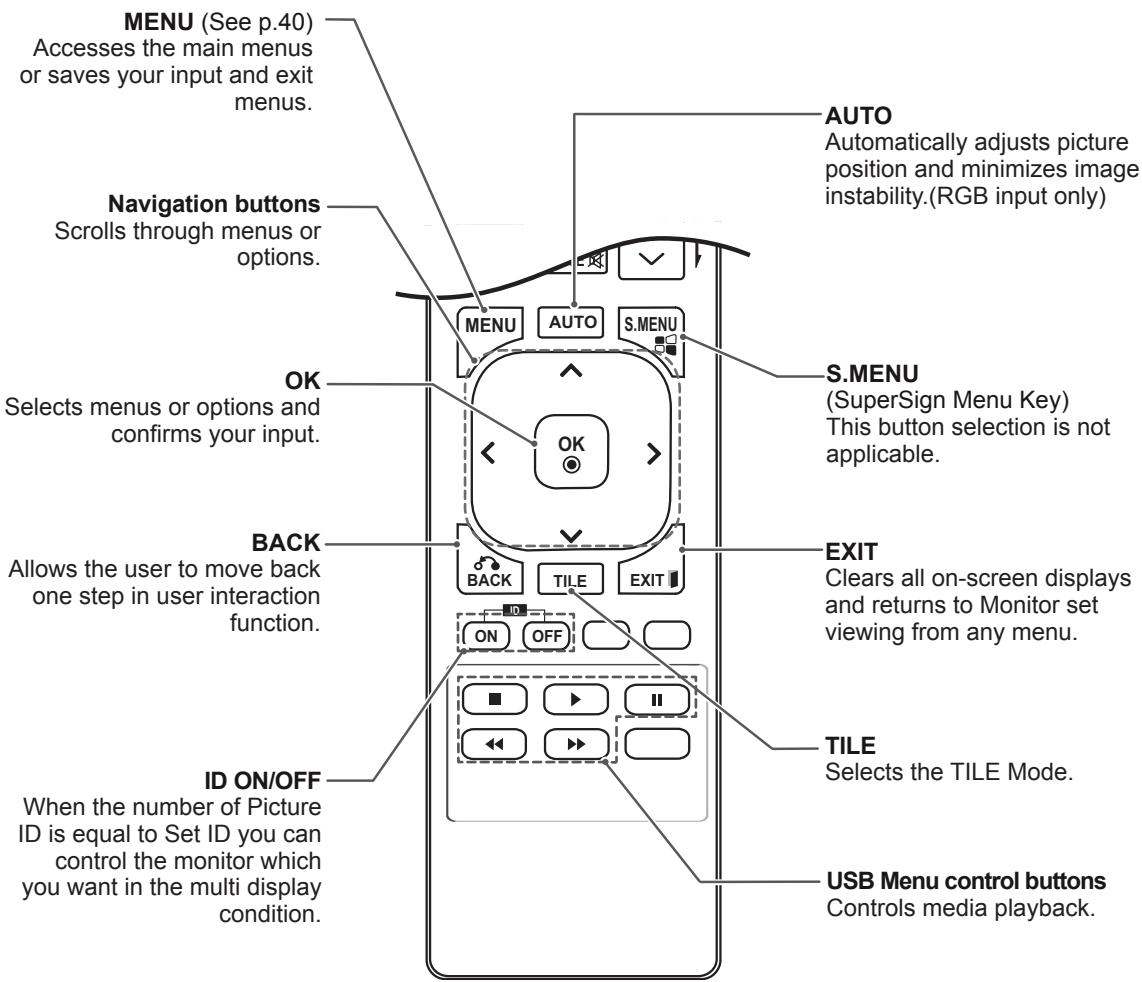
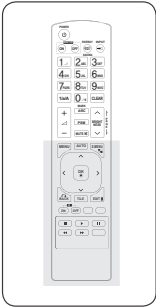

## Displaying the device name connected to an input port

Display which devices are connected to which external input ports.

- 1 Access the Input list screen and press the blue (input label) button on the remote control.

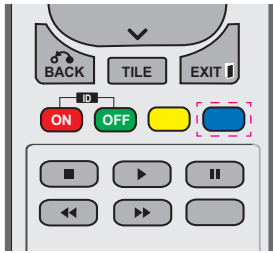

**NOTE**

- External inputs supported: AV, Component, RGB, HDMI, DVI-D, Display Port
- Labels available : VCR, DVD, Set top box, Satellite, Game, PC, Blue-ray, HD-DVD
- The input labels are displayed on the Input Label screen or at the top left of the screen when you change the external input setting.
- For DTV/PC-compatible signals, such as 1080p 60 Hz, the screen settings may change according to the input label. The Just Scan option is available if a PC is connected as an external device.

- 2 You can assign an input label for every input except USB.

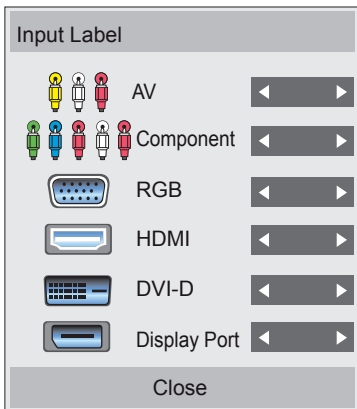

# USING THE MONITOR SET

## Connecting to a PC

Your Monitor set supports the Plug & Play\* feature.

\* Plug & Play: A PC will have a built-in driver for the monitor, no extra software is needed.

**NOTE**

- It is recommended to use the Monitor set with the HDMI connection for the best image quality.
- To comply with the specifications of the product, use a shielded interface cable with ferrite core, such as D-sub 15 pin cable and DVI/HDMI cable provided with the product.
- If you turn the Monitor set on when the set becomes cold, the screen may flicker. This is normal.
- Some red, green, or blue spots may appear on the screen. This is normal.

## RGB connection

Transmits the analog video signal from your PC to the Monitor set. Connect the PC and the Monitor set with the 15 pin signal cable as shown the following illustrations.

Select RGB input.

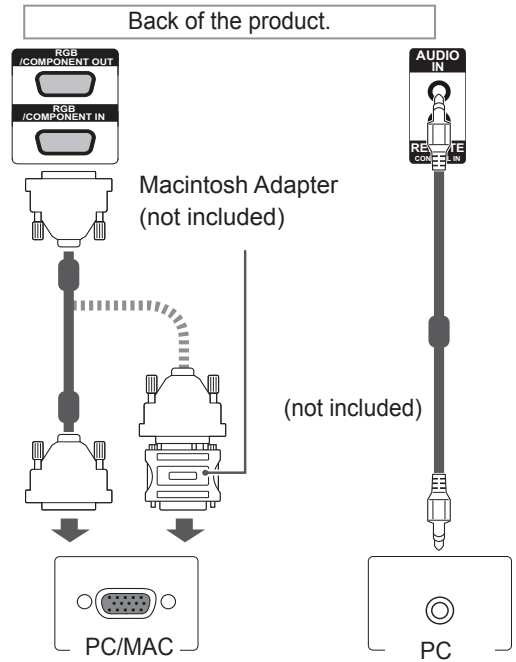

**CAUTION**

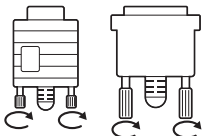

- Connect the signal input cable and tighten it by turning the screws clockwise.

- Do not press the screen with your finger for a long time as this may result in temporary distortion on the screen.
- Avoid displaying a fixed image on the screen for a long period of time to prevent image burn. Use a screensaver if possible.

**NOTE**

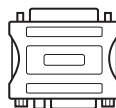

- Use the standard Macintosh adapter since an incompatible adapter is available in the market. (Different signaling system)
- Apple computers may require an adapter to connect to this monitor. Call or visit their web site for more information.

## DVI connection

Transmits digital video signal from your PC to the Monitor set. Connect the PC and the Monitor set with the DVI cable as shown the following illustrations.

Select DVI input.

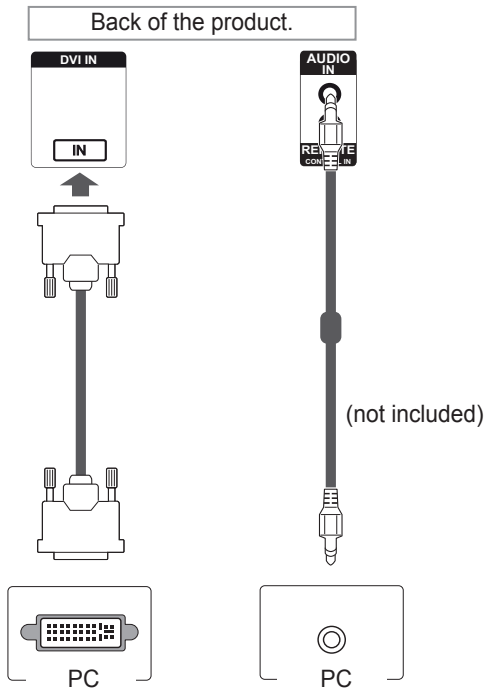

## HDMI connection

Transmits digital video and audio signals from your PC to the Monitor set. Connect the PC and the Monitor set with the HDMI cable as shown in the following illustrations.

Select HDMI input.

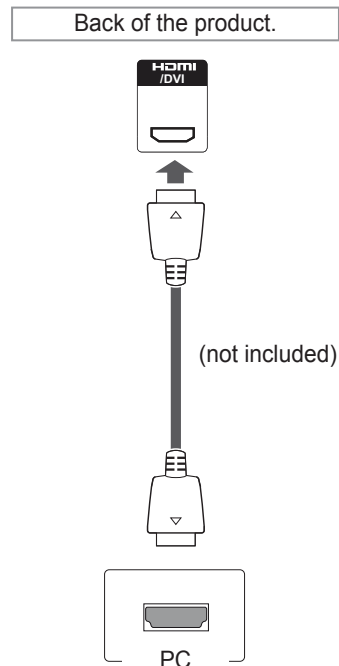

### NOTE

- Use a High Speed HDMI™ Cable.
- Please check the PC environment if you cannot hear the sound in HDMI mode. Some PCs require you to manually change the default audio output to HDMI.
- If you want to use HDMI-PC mode, you must set the input label to PC mode.
- When HDMI PC is used, a compatibility problem could occur.

## Display Port connection

Transmits digital video and audio signals from your PC to the Monitor. Connect the PC and the Monitor with the Display Port cable as shown in the following illustrations.

Select Display Port input source.

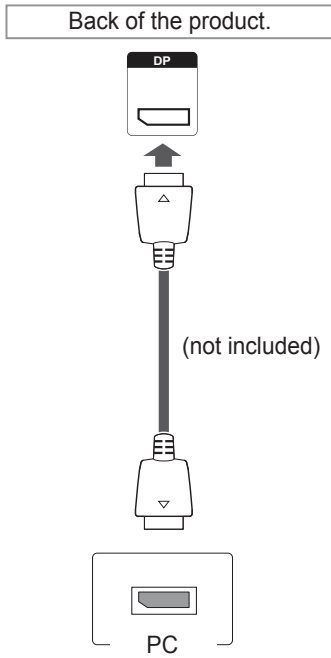

## IR Receiver connection

Allows the use of a wired remote or IR receiver extension.

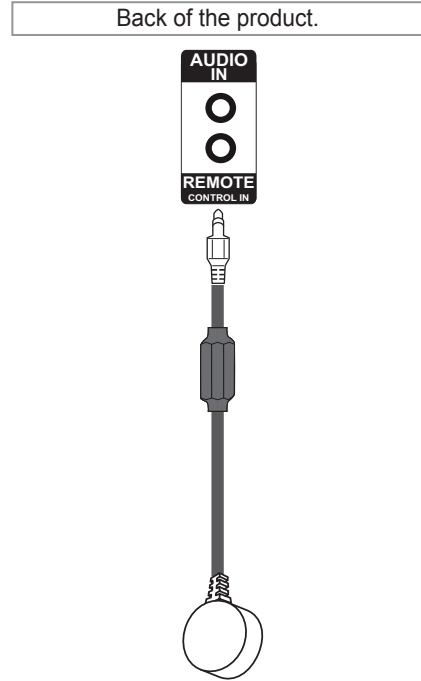

### ! NOTE

- Sound may not be available depending on the DP version of your PC.

## Adjusting the screen

### Selecting an image mode

Display images in its optimized settings by selecting one of the preset image modes.

- 1 Press **MENU** to access the main menus.
- 2 Press the Navigation buttons to scroll to **PICTURE** and press **OK**.
- 3 Press the Navigation buttons to scroll to **Picture Mode** and press **OK**.
- 4 Press the Navigation buttons to scroll to an image mode you want and press **OK**.

Mode	Description
<b>Vivid</b>	Adjusts the video image for the retail environment by enhancing the contrast, brightness, color, and sharpness.
<b>Standard</b>	Adjusts the image for the normal environment.
<b>Cinema</b>	Optimizes the video image for a cinematic look to enjoy movies as if you are in a movie theater.
<b>Sport</b>	Optimizes the video image for high and dynamic actions by emphasizing primary colors such as white, grass, or sky blue.
<b>Game</b>	Optimizes the video image for a fast gaming screen such as PCs or games.

- 5 When you are finished, press **EXIT**.  
When you return to the previous menu, press **BACK**.

### Customizing image options

Customize basic and advanced options of each image mode for the best screen performance.

- 1 Press **MENU** to access the main menus.
- 2 Press the Navigation buttons to scroll to **PICTURE** and press **OK**.
- 3 Press the Navigation buttons to scroll to **Picture Mode** and press **OK**.
- 4 Press the Navigation buttons to scroll to an image mode you want and press **OK**.
- 5 Select and adjust following options, and then press **OK**.

Option	Description
<b>Backlight</b>	Adjusts the brightness of the screen by controlling the LCD backlight. If you decrease the brightness level, the screen becomes darker and the power consumption will be reduced without any video signal loss.
<b>Contrast</b>	Increases or decreases the gradient of the video signal. You may use Contrast when the bright part of the picture is saturated.
<b>Brightness</b>	Adjusts the base level of the signal in the picture. You may use Brightness when the dark part of the picture is saturated.
<b>Sharpness</b>	Adjusts the level of crispness in the edges between the light and dark areas of the picture. The lower the level, the softer the image.
<b>Color</b>	Adjusts intensity of all colors.
<b>Tint</b>	Adjusts the balance between red and green levels.
<b>Color Temp.</b>	Set to warm to enhance hotter Colors such as red, or set to cool to make picture bluish.
<b>Advanced Control</b>	Customizes the advanced options. Refer to the Advanced image options.
<b>Picture Reset</b>	Restores the options to the default setting.

- 6 When you are finished, press **EXIT**.  
When you return to the previous menu, press **BACK**.

## Customizing PC display options

Customize options of each image mode for the best image quality.

- This function works in the following mode:  
RGB[PC] mode.
- 1 Press **MENU** to access the main menus.
  - 2 Press the Navigation buttons to scroll to **PICTURE** and press **OK**.
  - 3 Press the Navigation buttons to scroll to **Screen** and press **OK**.
  - 4 Select and adjust following options, and then press **OK**.

Option	Description
<b>Resolution</b>	Selects a proper resolution. See "Customizing PC display options".
<b>Auto Config.</b>	Sets to adjust the screen position, clock, and phase automatically. The displayed image may be unstable for a few seconds while the configuration is in progress.
<b>Position/ Size/Phase</b>	Adjusts the options when the picture is not clear, especially when characters are shaky, after the auto configuration.
<b>Reset</b>	Restores the options to the default setting.

- 5 When you are finished, press **EXIT**.  
When you return to the previous menu, press **BACK**.

## Adjusting the sound

### Selecting an sound mode

Play the sound in its optimized settings by selecting one of the preset sound modes.

- 1 Press **MENU** to access the main menus.
- 2 Press the Navigation buttons to scroll to **AUDIO** and press **OK**.
- 3 Press the Navigation buttons to scroll to **Sound Mode** and press **OK**.
- 4 Press the Navigation buttons to scroll to a sound mode you want and press **OK**.

Mode	Description
<b>Standard</b>	Select when you want standard-quality sound.
<b>Music</b>	Select when you listen to music.
<b>Cinema</b>	Select when you watch movies.
<b>Sports</b>	Select when you watch sports events.
<b>Game</b>	Select when you play games.

- 5 When you are finished, press **EXIT**.  
When you return to the previous menu, press **BACK**.



## Customizing sound options

Customize options of each sound mode for the best sound quality.

- 1 Press **MENU** to access the main menus.
- 2 Press the Navigation buttons to scroll to **AUDIO** and press **OK**.
- 3 Press the Navigation buttons to scroll to **Sound Mode** and press **OK**.
- 4 Press the Navigation buttons to scroll to a sound mode you want and press **OK**.
- 5 Select and adjust following options, and then press **OK**.

Option	Description
<b>Infinite Sound</b>	LG's Infinity Sound option provides 5.1 channel stereo sound quality from two speakers.
<b>Treble</b>	Increases the intensity of the high frequency part of audio.
<b>Bass</b>	Increases the intensity of the low frequency part of audio.
<b>Reset</b>	Resets the sound mode to the default setting.

- 6 When you are finished, press **EXIT**.  
When you return to the previous menu, press **BACK**.

## Using additional options

### Adjusting aspect ratio

Resize the image to view the image at its optimal size by pressing **ARC** while you are watching Monitor set.



#### CAUTION

- If a fixed image displays on the screen for a long period of time, it could be imprinted and become a permanent disfigurement on the screen. This is "image burn" or "burn-in" and not covered by the warranty.
- If the aspect ratio is set to 4:3 for a long period of time, image burn may occur on the letterboxed area of the screen.



#### NOTE

You can also change the image size by accessing the main menus.

MODE	AV	Component	RGB			Display Port			DVI-D		HDMI	
			PC	DTV	PC	PC	DTV	PC	DTV	PC		
<b>ARC</b>												
<b>16:9</b>	o	o	o	o	o	o	o	o	o	o	o	o
<b>Just Scan</b>	x	o	x	o	x	x	o	x	o	x		x
<b>1:1</b>	x	x	o	x	o	o	x	o	x	o		o
<b>4:3</b>	o	o	o	o	o	o	o	o	o	o		o
<b>Zoom</b>	o	o	x	o	x	x	o	x	o	x		x
<b>Cinema Zoom</b>	o	o	x	o	x	x	o	x	o	x		x

- **16:9** : This selection will allow you to adjust the picture horizontally, in linear proportion, to fill the entire screen(useful for viewing 4:3 formatted DVDs).
- **4:3** : This selection will allow you to view a picture with an original 4:3 aspect ratio, black bars will appear on both the left and right of the screen.

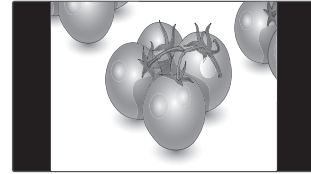
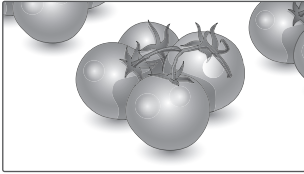

- **Just Scan** : This Selection will allow you view the picture of best quality without loss of original picture in high resolution image. Note: If there is noise in original Picture, You can see the noise at the edge.
- **Zoom** : This selection will allow you to view the picture without any alteration, while filling the entire screen. However, the top and bottom of the picture will be cropped.

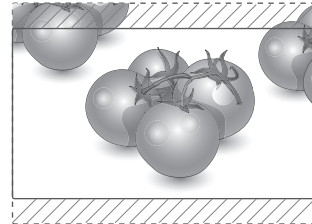

- **1:1** : The aspect ratio is not adjusted from the original. (Only Display Port PC, HDMI PC, DVI-D PC, RGB PC)
- **Cinema Zoom** : Choose Cinema Zoom when you want to enlarge the picture in correct proportion. Note: When enlarging or reducing the picture, the image may become distorted.

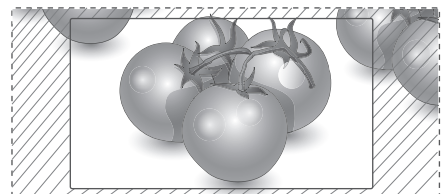
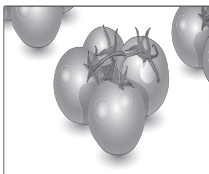

## Using the input list

### Selecting an input source

- 1 Press **INPUT** to access the input source list.
- 2 Press the Navigation buttons to scroll to one of the input sources and press **OK**.

Input source	Description
<b>AV(CVBS)</b>	Watch video from a VCR or other external devices.
<b>Component</b>	Watch the content from a DVD or other external devices, or through a digital set-top box
<b>RGB</b>	View a PC display on the screen
<b>DVI-D</b>	View a PC display on the screen
<b>HDMI</b>	Watch contents from a PC, DVD of Digital set-top box other high definition devices
<b>Display Port</b>	Watch contents in a PC, DVD of Digital set-top box other high definition devices

# ENTERTAINMENT

## Connecting to a wired network

Connect the display to a local area network (LAN) via the LAN port as shown on the following illustration and set up the network settings.

Only supports wired network connection.

After making a physical connection, a small number of networks may require the display network settings to be adjusted. For most networks, the display will connect to automatically without any adjustments.

For detail information, contact your internet provider or router manual.

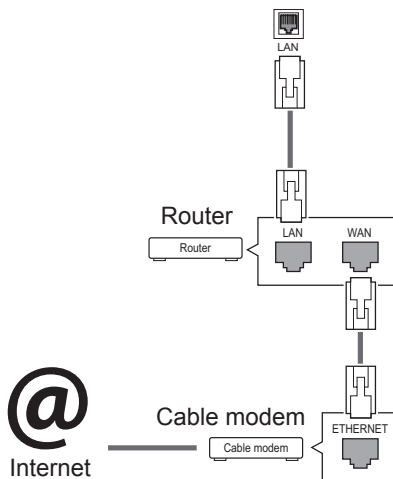

To set up the network settings: (Even if your display has already connected automatically, running setup again will not harm anything),

- 1 Press **MENU** to access the main menus.
- 2 Press the Navigation buttons to scroll to **NETWORK** and press **OK**.
- 3 Press the Navigation buttons to select **Network Setting** and press **OK**.
- 4 If you already set Network Setting, select **Resetting**. The new connection settings resets the current network settings.
- 5 Select **IP Auto Setting** or **IP Manual Setting**.
  - If selecting **IP Manual Setting**, press the Navigation and Number buttons. IP addresses will need to be input manually.
  - **IP Auto Setting**: Select this if there is a DHCP server (Router) on the local area network (LAN) via wired connection, the display will automatically be allocated an IP address. If you're using a broadband router or broadband modem that has a DHCP (Dynamic Host Configuration Protocol) server function. The IP address will automatically be determined.
- 6 When you are finished, press **EXIT**.

### CAUTION

- Do not connect a modular phone cable to the LAN port.
- Since there are various connection methods, please follow the specifications of your telecommunication carrier or internet service provider.

### CAUTION

- Network setting menu will not be available until the display connected to physical network.
- Since there are various connection methods, please follow the specifications of your telecommunication carrier or internet service provider.

**NOTE**

- If you want to access the Internet directly on your display, the internet connection should always be on.
- If you cannot access the Internet, check the network conditions from a PC on your network.
- When you use **Network Setting**, check the LAN cable or check if DHCP in the router is turned on.
- If you do not complete the network settings, the network may not work properly.

**Tips for Network setting**

- Use a standard LAN cable with this display. Cat5 or better with a RJ45 connector.
  - Many network connection problems during set up can often be fixed by re-setting the router or modem. After connecting the display to the network, quickly power off and/or disconnect the power cable of the network router or cable modem. Then power on and/or connect the power cable again.
  - Depending on the internet service provider (ISP), the number of devices that can receive internet service may be limited by the applicable terms of service. For details, contact your ISP.
  - LG is not responsible for any malfunction of the display and/or the internet connection feature due to communication errors/malfunctions associated with your internet connection, or other connected equipment.
  - LG is not responsible for problems within your internet connection.
  - You may experience undesired results if the network connection speed does not meet the requirements of the content being accessed.
  - Some internet connection operations may not be possible due to certain restrictions set by the Internet service provider (ISP) supplying your Internet connection.
  - Any fees charged by an ISP including, without limitation, connection charges are your responsibility.
  - A 10 Base-T or 100 Base-TX LAN port is required when using a wired connection to this display. If your internet service does not allow for such a connection, you will not be able to connect the display.
- A DSL modem is required to use DSL service and a cable modem is required to use cable modem service. Depending on the access method of and subscriber agreement with your ISP, you may not be able to use the internet connection feature contained in this display or you may be limited to the number of devices you can connect at the same time. (If your ISP limits sub-scription to one device, this display may not be allowed to connect when a PC is already connected.)
  - The use of a “Router” may not be allowed or its usage may be limited depending on the policies and restrictions of your ISP. For details, contact your ISP directly.

**Network Status**

- 1 Press **MENU** to access the main menus.
- 2 Press the Navigation buttons to scroll to **NETWORK** and press **OK**.
- 3 Press the Navigation buttons to select **Network Status**.
- 4 Press **OK** to check the network status.
- 5 When you are finished, press **EXIT**.

Option	Description
<b>Setting</b>	Return to the network setting menu.
<b>Test</b>	Test the current network status after setting the network.
<b>Close</b>	Return to the previous menu.

## Connecting USB storage devices

Connect USB storage devices such as a USB flash memory, external hard drive to the display and use multimedia features (See "Browsing files" on page 27).

Connect a USB flash memory or USB memory card reader to the Display as shown on the following illustration. The My media screen appears.

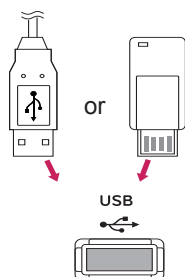

### CAUTION

- Do not turn the display off or remove a USB storage device while EMF(my media) Menu is activated, as this could result in loss of files or damage to the USB storage device.
- Back up your files saved on a USB storage device frequently, as you may lose or damage the files and this may be not covered by the warranty.

### Tips for using USB storage devices

- Only a USB storage device is recognizable.
- If the USB storage device is connected through a USB hub, the device is not recognizable.
- A USB storage device using an automatic recognition programme may not be recognized.
- A USB storage device which uses its own driver may not be recognized.
- The recognition speed of a USB storage device may depend on each device.
- Please do not turn off the display or unplug the USB device when the connected USB storage device is working. When such device is suddenly separated or unplugged, the stored files or the USB storage device may be damaged.
- Please do not connect the USB storage device which was artificially maneuvered on the PC. The device may cause the product to malfunction or fail to be played. Never forget to use only a USB storage device which has normal music files, image files or movie files.
- Please use only a USB storage device which was formatted as a FAT32 file system, NTFS file system provided with the Windows operating system. In case of a storage device formatted as a different utility program which is not supported by Windows, it may not be recognized.
- Please connect power to a USB storage device(over 0.5 A) which requires an external power supply. If not, the device may not be recognized.
- Please connect a USB storage device with the cable offered by the device maker.
- Some USB storage devices may not be supported or operated smoothly.
- File alignment method of USB storage device is similar to Window XP and filename can recognize up to 100 English characters.

- Be sure to back up important files since data stored in a USB memory device may be damaged. We will not be responsible for any data loss.
- If the USB HDD does not have an external power source, the USB device may not be detected. So be sure to connect the external power source.
  - Please use a power adaptor for an external power source. We do not guarantee an USB cable for an external power source.
- If your USB memory device has multiple partitions, or if you use a USB multi-card reader, you can use up to 4 partitions or USB memory devices.
- If a USB memory device is connected to a USB multi-card reader, its volume data may not be detected.
- If the USB memory device does not work properly, disconnect and reconnect it.
- How fast a USB memory device is detected differs from device to device.
- If the USB is connected in Standby Mode, specific hard disk will automatically be loaded when the display is turned on.
- The recommended capacity is 1 TB or less for a USB external hard disk and 32 GB or less for USB memory.
- Any device with more than the recommended capacity may not work properly.
- If a USB external hard disk with a “Energy Saving” function does not work, turn the hard disk off and on again to make it work properly.
- USB storage devices below USB 2.0 are supported as well. But they may not work properly in the movie list.
- Maximum of 999 folders or files can be recognized under one folder.
- A USB 3.0 storage device may not work.

## Browsing files

Access the photo, music, or movie lists and browse files.

- 1 Connect a USB storage device.
- 2 Press **MENU** to access the main menus.
- 3 Press the Navigation buttons to scroll to **My Media** and press **OK**.
- 4 Press the Navigation buttons to choose from **Movie List**, **Photo List**, **Music List** or **Contents List** and press **OK**.

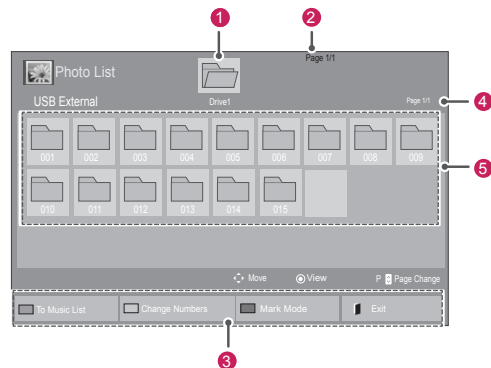
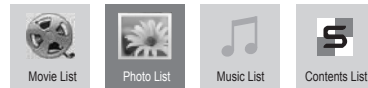

No.	Description
1	Moves to upper level folder
2	Current page/Total pages
3	Corresponding buttons on the remote control
4	Current page/ total pages of contents under the folder focused on 1
5	Contents under the folder focused on 1
Button	Description
Green button	Press the green button to toggle between <b>Photo List -&gt; Music List, Music List -&gt; Contents List, Contents List -&gt; Movie List</b> or <b>Movie List -&gt; Photo List</b> .
Yellow button	A method to view in 5 large thumbnail or simple list.
Blue button	Convert to Mark Mode.

Supported file format

Type	Supported file format		
Movie	<b>DAT,MPG,MPEG,VOB,AVI,DIVX,MP4,MKV,TS,TRP,TP,ASF,WMV,FLV)</b> <b>Movie</b> (* .mpg/* .mpeg/* .dat/* .ts/* .trp/* .tp/* .vob/* .mp4/* .mov/* .mkv/* .divx/* .avi/* .asf/* .wmv/* .flv/* .avi(motion-jpeg)/* .mp4(motion-jpeg)/* .mkv(motion-jpeg))supporting file <b>Video format</b> : DivX 3.11, DivX4, DivX5, DivX6, Xvid1.00, Xvid1.01, Xvid1.02, Xvid1.03, Xvid1.10 beta-1/beta-2, Mpeg-1, Mpeg-2, Mpeg-4, H.264/AVC, VC1, JPEG, Sorenson H.263 <b>Audio format</b> : Dolby Digital, AAC, Mpeg, MP3, LPCM, HE-AAC, ADPCM, WMA <b>Bit rate</b> : within 32 kbps to 320 kbps(MP3) <b>External Subtitle format</b> : *.smi/* .srt/* .sub (MicroDVD,Subviewer1.0/2.0)/* .ass/* .ssa/* .txt(TMPlayer)/* .psb(PowerDivX) <b>Internal Subtitle format</b> : only, XSUB (It is the subtitle format used in DivX6 files)		
	<b>Photo</b> JPEG Baseline : 64 x 64 to 15360 x 8640 Progressive : 64 x 64 to 1920 x 1440 • You can play JPEG files only. • Non-supported files are displayed in the form of predefined icon.		
<b>Only 3D Models</b>			
	File Extensions	Item	Profile
2D	jpeg jpg jpe	supported file format	SOF0: baseline SOF1: Extend Sequential SOF2: Progressive
		photo size	Min: 64 x 64 Max-Normal Type: 15360 (W) x 8640 (H) Progressive Type: 1920 (W) x 1440 (H)
3D	mpo	supported file format	mpo
		photo size	4:3 size: 3,648 x 2,736 2,592 x 1,944 2,048 x 1,536 3:2 size: 3,648 x 2,432

Music	MP3 Bit rate 32 to 320 <ul style="list-style-type: none"> <li>• Sampling rate MPEG1 Layer3 : 32 kHz, 44.1 kHz, 48 kHz</li> <li>• Sampling rate MPEG2 Layer3 : 16 kHz, 22.05 kHz, 24 kHz</li> <li>• Sampling rate MPEG2.5 Layer3 : 8 kHz, 11.025 kHz, 12 kHz</li> </ul>		
	Content (when using SuperSign Manager)	File Extensions : *.cts/* .cse Movie <b>File Extensions:</b> *.mpg/* .mpeg/* .dat/* .ts/* .trp/* .tp/* .vob/* .mp4/* .mov/* .mkv/* .avi/* .asf/* .wmv/* .avi(motion JPEG)/* .mp4(motion JPEG)/* .mkv(motion JPEG) <b>Video format:</b> MPEG1, MPEG2, MPEG4,H.264/AVC, DivX 3.11, DivX4, DivX5, DivX6 Xvid 1.00, Xvid 1.01, Xvid 1.02, Xvid 1.03,Xvid 1.10-beta1/2, JPEG, VC1(WVC1/WMV3) <b>Audio format:</b> MP2,MP3,Dolby Digital, LPCM, AAC, HE-AAC,LPCM, ADPCM, WMA, MP3	
	File Extensions	Item	Profile
Photo	JPEG JPG PNG BMP	supported file format	SOF0: baseline SOF1: Extend Sequential SOF2: Progressive
		Photo size	Min: 64 x 64 Max Type: 1366 x 768
Music	MP3	Bit rate	32 kbps to 320 kbps
		Sampling rate	32 kHz, 44.1 kHz, 48 kHz (MPEG1 L3) 16 kHz, 22.05 kHz, 24 kHz (MPEG2 L3) 8kHz, 11.025 kHz, 12 kHz (MPEG2.5 L3)



## Viewing movies

Play video files on display. Your display shows all of the video files saved in a USB storage device or shared folder on a PC.

- 1 Press the Navigation buttons to scroll to **My Media** and press **OK**.
- 2 Press the Navigation buttons to scroll to **Movie List** and press **OK**.
- 3 Press the Navigation buttons to scroll to a folder you want and press **OK**.
- 4 Press the Navigation buttons to scroll to a file you want and press **OK**.

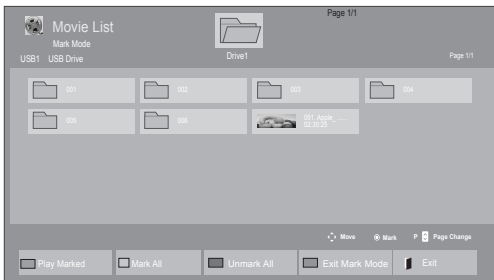
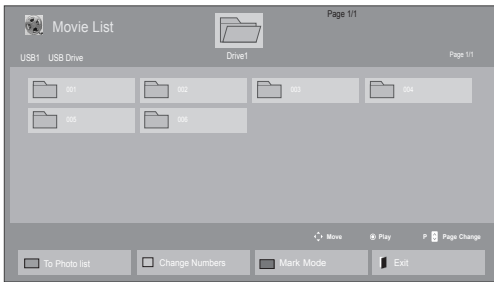

Menu	Description
<b>Play Marked</b>	Play the selected movie file. Once a movie file finishes playing, the next selected one will be played automatically.
<b>Mark All</b>	Mark all movie files on the screen.
<b>Unmark All</b>	Deselect all marked movie files.
<b>Exit Mark Mode</b>	Exit the Mark Mode.

- 5 Play a movie.

### NOTE

- Non-supported files are displayed the preview image by icon only **5A**.
- Abnormal files are displayed in the form of bitmap **5B**.

- 6 Control playback by using the following buttons.



Button	Description
	Stops the playback
	Plays a video
	Pauses or resumes the playback
	Scans backward in a file
	Scans forward in a file
<b>MENU</b>	Show the <b>Option</b> menu.
<b>HIDE</b>	Hide the menu on the full-sized screen.
<b>EXIT</b>	Return to <b>Movie List</b> .
<b>&lt; or &gt;</b>	Skips to specific points in a file during playback. The time of a specific point will appear on the status bar. In some files, this function may not work properly.
<b>ENERGY SAVING(e)</b>	Press the <b>ENERGY SAVING</b> button repeatedly to increase the brightness of your screen.

**Tips for using playing video files**

- Some user-created subtitles may not work properly.
- Some special characters are not supported in subtitles.
- HTML tags are not supported in subtitles.
- Subtitles in languages other than the supported languages are not available.
- The screen may suffer temporary interruptions (image stoppage, faster playback, etc.) when the audio language is changed.
- A damaged movie file may not be played correctly, or some player functions may not be usable.
- Movie files produced with some encoders may not be played correctly.
- If the video and audio structure of recorded file is not interleaved, either video or audio is outputted.
- Videos with resolutions higher than 1920X1080@25/30P may not work properly depending on the frame.
- Movie files other than the specified types and formats may not work properly.
- Max bitrate of playable movie file is 20 Mbps. (only, Motion JPEG : 10 Mbps)
- We do not guarantee smooth playback of profiles encoded level 4.1 or higher in H.264/AVC.
- DTS Audio codec is not supported.
- A movie file more than 30 GB in file size is not supported for playback.
- A DivX movie file and its subtitle file must be located in the same folder.
- A video file name and its subtitle file name must be identical for it to be displayed.
- Playing a video via a USB connection that doesn't support high speed may not work properly.
- Files encoded with GMC(Global Motion Compensation) may not be played.
- When you are watching the movie by Movie List function, you can adjust an image by Energy Saving key on the remote control. User setup for each image mode does not operate.

**Video options**

- 1 Press **MENU** to access the **Pop-Up** menus.
- 2 Press the Navigation buttons to scroll to **Set Video Play.**, **Set Video.** or **Set Audio.** and press **OK**.

**NOTE**

- Option values changed in **Movie List** does not affect **Photo List** and **Music List**.
- Option value changed in **Photo List** and **Music List** are changed likewise in **Photo List** and **Music List** excluding **Movie List**.
- When replaying the video file after stopping, you can play from where it stopped previously.

When you select the **Set Video Play**,

- 1 Press the Navigation buttons to scroll to show the **Picture Size, Audio Language, Subtitle Language** or **Repeat**.
- 2 Press the Navigation buttons to scroll to make appropriate adjustments.

Menu	Description
<b>Picture Size</b>	Selects your desired picture format during movie play.
<b>Audio Language</b>	Changes the Language Group of the audio during movie play. Files with a single audio track cannot be selected.
<b>Subtitle Language</b>	Turn on/off the subtitle.
<b>Language</b>	Activated for SMI subtitle and can select the language within the subtitle.
<b>Code Page</b>	Can select the font for subtitle. When set to default, same font as general menu will be used.
<b>Sync</b>	Adjusts the time synchronisation of the subtitle from -10 secs to +10 secs by steps of 0.5 secs during movie play.
<b>Position</b>	Changes the position of the subtitle either up or down during movie play.
<b>Size</b>	Selects your desired Subtitle size during movie play.
<b>Repeat</b>	Turn on/off repeat function of movie playback. When turned on, the file within the folder will be played back repeatedly. Even when the repeated playback is turned off, it can run the playback if the file name is similar to the previous file.

Code Page	Support Language
<b>Latin1</b>	English, Spanish, French, German, Italian, Portuguese, Danish, Romanian, Norwegian, Albanian, Gaelic, Welsh, Irish, Catalan, Valencian
<b>Latin2</b>	Bosnian, Polish, Croatian, Czech, Slovak, Slovenian, Serbian, Hungarian
<b>Latin4</b>	Estonian, Latvian, Lithuanian
<b>Cyrillic</b>	Bulgarian, Macedonian, Russian, Ukrainian, Kazakh
<b>Greek</b>	Greek
<b>Turkish</b>	Turkish
<b>Korean</b>	Korean

### NOTE

- Only 10,000 of sync blocks can be supported within the subtitle file.
- When playing a video, you can adjust the Picture Size by pressing the RATIO button.
- Subtitles in your language are only supported when the OSD menu is also in this language.
- The code page options may be disabled depending on the language of the subtitle files.
- Select the appropriate code page for the subtitle files.

When you select the **Set Video**,

- 1 Press the Navigation buttons to scroll to make appropriate adjustments.

When you select the **Set Audio**,

- 1 Press the Navigation buttons to scroll to show the **Sound Mode**, **Clear Voice II** or **Balance**.
- 2 Press the Navigation buttons to scroll to make appropriate adjustments.

## Viewing photos

View image files saved in a USB storage device. The displays on the screen may differ from the model.

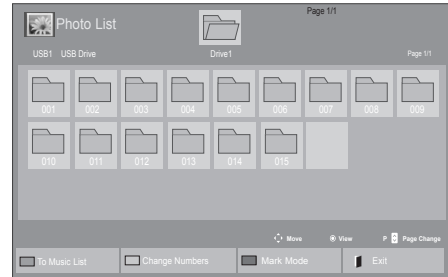

- 1 Press the Navigation buttons to scroll to **My Media** and press **OK**.
- 2 Press the Navigation buttons to scroll to **Photo List** and press **OK**.
- 3 Press the Navigation buttons to scroll to a folder you want and press **OK**.
- 4 Press the Navigation buttons to scroll to a file you want and press **OK**.



Menu	Description
<b>View Marked</b>	Display the selected photo file.
<b>Mark All</b>	Mark all photo files on the screen.
<b>Unmark All</b>	Deselect all marked photo files.
<b>Exit Mark Mode</b>	Exit the Mark Mode.

- 5 View photos.

### NOTE

- Non-supported files are displayed the pre-view image by icon only .
- Abnormal files are displayed in the form of bitmap .

**Using photo options**

Use the following options while viewing photos.



Options

Number of selected photos

Option	Description
<b>Slideshow</b>	Starts or stops a slideshow with selected photos. If there are no selected photos, all photos saved in the current folder display during a slideshow. To set a slideshow speed, select <b>Option</b> .
<b>BGM</b>	Turns the background music on or off. To set the background music folder, select <b>Option</b> . You can adjust Option by MENU button on the remote control.
<b>⌚ (Rotate)</b>	Rotates photos clockwise (90°, 180°, 270°, 360°).  <div style="border: 1px solid black; padding: 5px;"> <p><b>NOTE</b></p> <ul style="list-style-type: none"> <li>The supported photo size is limited. You cannot rotate a photo if the resolution of the rotated width is larger than the supported resolution size.</li> </ul> </div>
<b>🔍</b>	View the photo by zoom in 2, 4 times.  <div style="border: 1px solid black; padding: 5px;"> <p><b>NOTE</b></p> <ul style="list-style-type: none"> <li>Photos with a resolution of 960x540 or less cannot be enlarged.</li> </ul> </div>

<b>ENERGY SAVING(e)</b>	Press the <b>ENERGY SAVING</b> button repeatedly to change the brightness of your screen.
<b>Option</b>	<ul style="list-style-type: none"> <li><b>Slide Speed:</b> Selects a slideshow speed (<b>Fast, Medium, Slow</b>).</li> <li><b>TransitionEffect:</b> Set the view mode of the slideshow.</li> <li><b>BGM:</b> Selects a music folder for the background music.</li> </ul> <div style="border: 1px solid black; padding: 5px; margin-top: 10px;"> <p><b>NOTE</b></p> <ul style="list-style-type: none"> <li>You cannot change the music folder while the background music is playing.</li> <li>You can only select the MP3 folder saved on the device that currently displays the photo.</li> </ul> </div>
<b>Hide</b>	Hides the option window. To display the options, press <b>OK</b> .
<b>EXIT</b>	Return to <b>Photo List</b> .

**Photo options**

- 1 Press **MENU** to show the **Option** menus.
- 2 Press the Navigation buttons to scroll to **Set Photo View, Set Video** or **Set Audio** and press **OK**.





**NOTE**

- Option values changed in **Movie List** does not affect **Photo List** and **Music List**.
- Option value changed in **Photo List** and **Music List** are changed likewise in **Photo List** and **Music List** excluding **Movie List**.

When you select the **Set Photo View**,

- 1 Press the Navigation buttons to scroll to select **Slide Speed**, **Transition Effect** or **BGM**.
- 2 Press the Navigation buttons to scroll to make appropriate adjustments.

### Transition Effect Option

Option	Description
Sliding	Pushes the current slide out of view as it plays to the next slide. 
Stairs	Pushes the current slide in a staircase shape as it plays to the next slide. 
Door Open /Close	Pushes the current slide like opening or closing the door as it plays to the next slide. 
Shutter	Pushes the current slide like drawing or pulling down the blind as it plays to the next slide 
Fade In	Fades the slide out slowly before playing to the next slide. 

When you select the **Set Video**,

- 1 Press the Navigation buttons to scroll to make appropriate adjustments.

When you select the **Set Audio**,

- 1 Press the Navigation buttons to scroll to show the **Sound Mode**, **Clear Voice II** or **Balance**.
- 2 Press the Navigation buttons to scroll to make appropriate adjustments.

## Listening to music

- 1 Press the Navigation buttons to scroll to **My Media** and press **OK**.
- 2 Press the Navigation buttons to scroll to **Music List** and press **OK**.
- 3 Press the Navigation buttons to scroll to a folder you want and press **OK**.
- 4 Press the Navigation buttons to scroll to a file you want and press **OK**.

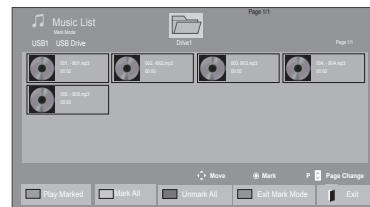
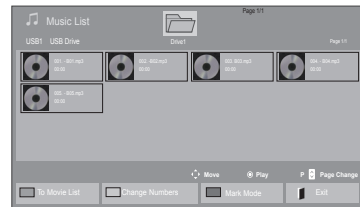

Menu	Description
<b>Play Marked</b>	Display the selected music file.
<b>Mark All</b>	Mark all music files on the screen.
<b>Unmark All</b>	Deselect all marked music files.
<b>Exit Mark Mode</b>	Exit the Mark Mode.

- 5 Play music.

## 6 Control playback by using the following buttons.

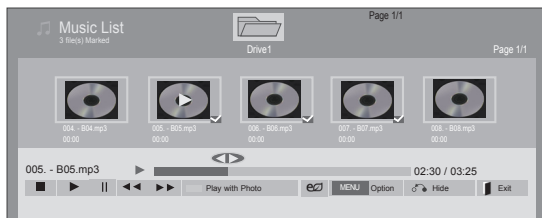

Button	Description
	Stops playing back the file and moves back to the music list.
	Plays a music file
	Pauses or resumes playback
	Skips to the next file
	Skips to the previous file
	When playing, When you press the  button, the previous music file will be played. When you press the  button, the next music file will be played.
Green button	Start playing the selected music files and then move to the <b>Photo List</b> .
<b>ENERGY SAVING</b> (eZ)	Press the <b>ENERGY SAVING</b> button repeatedly to change the brightness of your screen.
<b>MENU</b>	Show the Option menu.
<b>Hide</b>	Hides the option window. To display the options, press <b>OK</b> .
<b>EXIT</b>	When you press the <b>EXIT</b> button while the Music player is displayed, only the music will be stopped and the player will not return to normal viewing. When you press the <b>EXIT</b> button while the music is stopped or while the music player is hidden, the player will return to normal viewing.
<b>&lt; or &gt;</b>	When using the <b>&lt;</b> or <b>&gt;</b> button during playback a cursor indicating the position can be played.

## Tips for playing music files

- This unit cannot support the ID3 Tag embedded MP3 files.

## ! NOTE

- Non-supported files are displayed the preview image by icon only
- Abnormal files are displayed in the form of bitmap
- A damaged or corrupted music does not play but displays 00:00 in playtime.
- A music downloaded from a paid service with copyright protection does not start but displays inappropriate information in playtime.
- If you press OK, buttons, screen saver is stopped.
- The PLAY () , Pause () , , ) , buttons on the remote control are also available in this mode.
- You can use the button to select the next music and the button to select the previous music.

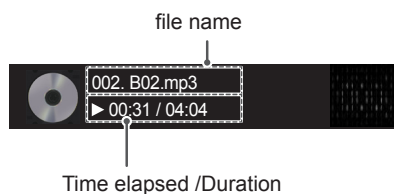



**Music options**

- 1 Press **MENU** to access the **Pop-Up** menus.
- 2 Press the Navigation buttons to scroll to **Set Audio Play** or **Set Audio** and press **OK**.

**NOTE**

- Option values changed in **Movie List** does not affect **Photo List** and **Music List**.
- Option value changed in **Photo List** and **Music List** are changed likewise in **Photo List** and **Music List** excluding **Movie List**.

When you select the **Set Audio Play**,

- 1 Press the Navigation buttons to scroll to select the **Repeat** or **Random**.
- 2 Press the Navigation buttons to scroll to make appropriate adjustments.

When you select the **Set Audio**,

- 1 Press the Navigation buttons to scroll to select the **Sound Mode**, **Clear Voice II** or **Balance**.
- 2 Press the Navigation buttons to scroll to make appropriate adjustments.

**Viewing the Contents List**

Plays back the stored files using the Export option in SuperSign Manager.

- 1 Press the Navigation buttons to scroll to **My Media** and press **OK**.
- 2 Press the Navigation buttons to scroll to **Contents List** and press **OK**.
- 3 Press the Navigation buttons to scroll to a folder you want and press **OK**.
- 4 Press the Navigation buttons to scroll to a file you want and press **OK**.

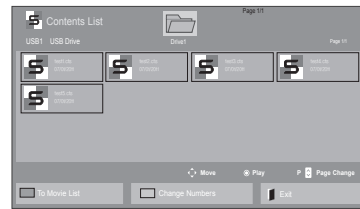
**NOTE**

- While playing media files from Contents List, only the **BACK**, **EXIT** or Volume button are available. Selecting the **BACK** or **EXIT** button stops playing media files and returns to the screen view mode.
- If there is the **AutoPlay** folder in the USB device and its files are in supported formats, they can be played back automatically when the USB device is connected to the monitor.

## DivX® VOD Guide

### DivX® VOD Registration

In order to play purchased or rented DivX® VOD contents, you should register your device with 10 digit DivX registration code from your device at [www.divx.com/vod](http://www.divx.com/vod).

- 1 Press **MENU** to access the main menus.
- 2 Press the Navigation buttons to scroll to **MY MEDIA** and press **OK**.
- 3 Press the Blue button.
- 4 Press the Navigation buttons to scroll to **DivX Reg. Code** and press **OK**.
- 5 View the registration code of your display.
- 6 When you are finished, press **EXIT**.  
When you return to the previous menu, press **BACK**.

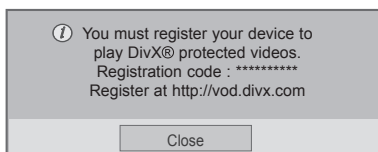

### ! NOTE

- While you are checking the registration code, some buttons may not work.
- If you use the DivX registration code of another device, you cannot play the rented or purchased DivX file. Make sure to use the DivX registration code assigned to your TV.
- The video or audio files that are not converted by the standard DivX codec may be corrupted or not be played.
- The DivX VOD code allows you to activate up to 6 devices under one account.

### DivX® VOD Deregistration

You should deregister your device with 8 digit DivX deregistration code from your device at [www.divx.com/vod](http://www.divx.com/vod).

- 1 Press **MENU** to access the main menus.
- 2 Press the Navigation buttons to scroll to **MY MEDIA** and press **OK**.
- 3 Press the Blue button.
- 4 Press the Navigation buttons to scroll to **Deactivation** and press **OK**.
- 5 Press the Navigation buttons to select **Yes** to confirm.

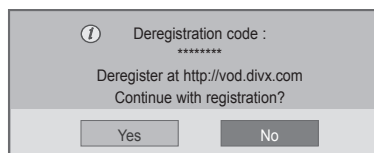

- 6 When you are finished, press **EXIT**.  
When you return to the previous menu, press **BACK**.

### ! NOTE

- Once the deregistration is executed, you must register your device again to see DivX® VOD contents.

## Using PIP/PBP

Displays videos or photos stored on a USB device on a single monitor by dividing it into the main and sub screens. (See p.50)

- 1 Press the MENU button to move to **OPTION** and press **OK**.
- 2 Press **PIP/PBP** to select **PIP** or **PBP** and then press **OK**.

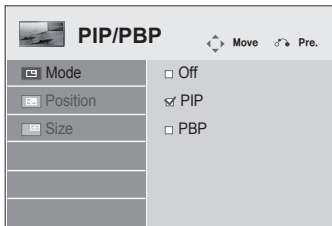

- 3 Select **Movie List** or **Photo List** from **My Media**. (With **PIP/PBP** selected, the **Music List** and **Contents List** are deactivated.)

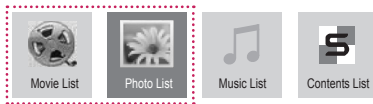

- 4 Select a file you want and then press **OK**.

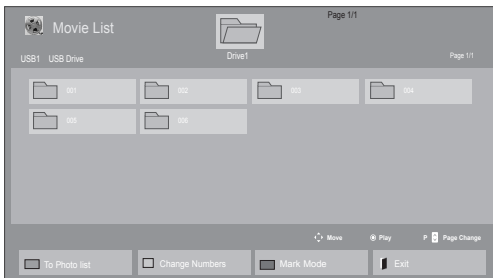

- 5 Select the PIP or PBP icon from the play list.



< Movie List >



< Photo List >

- 6 Select either Main or Sub for sound. You must to select the output sound before running the PIP or PBP function.

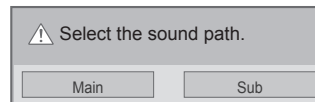

- 7 The sub screen is displayed on the main screen.



# CUSTOMIZING SETTINGS

## Accessing the main menus

- 1 Press **MENU** to access the main menus.
- 2 Press the Navigation buttons to scroll to one of the following menus and press **OK**.
- 3 Press the Navigation buttons to scroll to the setting or option you want and press **OK**.
- 4 When you are finished, press **EXIT**.  
When you return to the previous menu, press **BACK**.

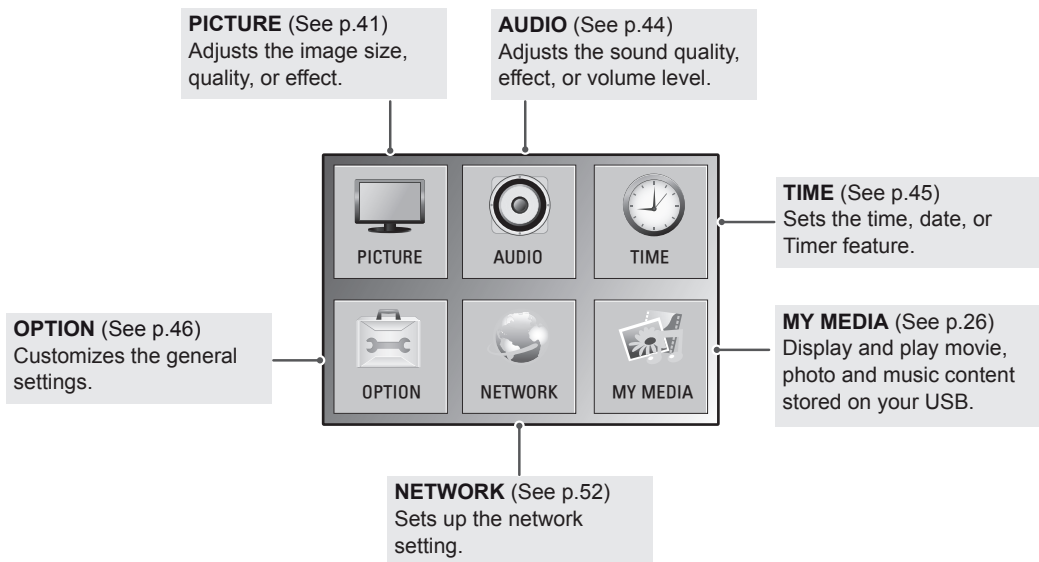
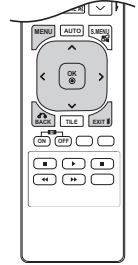

## PICTURE settings

- 1 Press **MENU** to access the main menus.
- 2 Press the Navigation buttons to scroll to **PICTURE** and press **OK**.
- 3 Press the Navigation buttons to scroll to the setting or option you want and press **OK**.  
- To return to the previous level, press **BACK**.
- 4 When you are finished, press **EXIT**.  
When you return to the previous menu, press **BACK**.

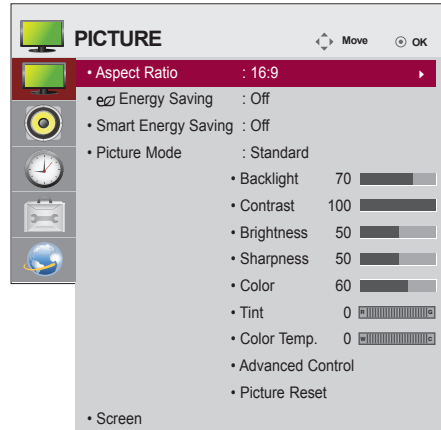

The available picture settings are described in the following:

Setting	Description
<b>Aspect Ratio</b>	Changes the image size to view images at its optimal size (See p.21).
<b>Energy Saving</b>	Sets to automatically adjust the screen brightness corresponding to the surroundings.
	<b>Level</b>
	Off Disables Energy Saving function.
	Minimum/ Medium/ Maximum Selects the brightness level of the backlight.
	Screen Off The screen turns off in 3 seconds.
<b>Smart Energy Saving</b>	Adjusts the backlight and contrast depending on the screen brightness.
	<b>Level</b>
	On Enables the Smart Energy Saving function to save power consumption as much as the value set in the smart energy saving rate.
	Off Disables the Smart Energy Saving function.
<b>Picture Mode</b>	Selects one of the preset image or customizes options in each mode for the best Monitor set screen performance. You are also able to customize advanced options of each mode. The available preset picture modes vary depending on the Monitor set .
	<b>Mode</b>
	Vivid Adjusts the video image for the retail environment by enhancing the contrast, brightness, Color, and sharpness.
	Standard Adjusts the image for the normal environment.
	Cinema Optimizes the video image for a cinematic look to enjoy movies as if you are in a movie theater.
	Sport Optimizes the video image for high and dynamic actions by emphasizing primary Colours such as white, grass, or sky blue.
	Game Optimizes the video image for a fast gaming screen such as PCs or games.

Setting	Description	
<b>SCREEN</b> (In RGB Mode Only)	Customizes the PC display options in RGB mode.	
	<b>Option</b>	
	Resolution	Selects a proper resolution. See "Customizing PC display options".
	Auto Configure	Sets to adjust the screen position, clock, and phase automatically. The displayed image may be unstable for a few seconds while the configuration is in progress.
	Position/Size/ Phase	Adjusts the options when the picture is not clear, especially when characters are shaky, after the auto configuration.
Reset	Restores the options to the default setting.	

### Basic image options

Setting	Description
<b>Backlight</b>	Adjusts the brightness of the screen by controlling the LCD backlight. If you decrease the brightness level, the screen becomes darker and the power consumption will be reduced without any video signal loss.
<b>Contrast</b>	Increases or decreases the gradient of the video signal. You may use Contrast when the bright part of the picture is saturated.
<b>Brightness</b>	Adjusts the base level of the signal in the picture. You may use Brightness when the dark part of the picture is saturated.
<b>Sharpness</b>	Adjusts the level of crispness in the edges between the light and dark areas of the picture. The lower the level, the softer the image.
<b>Color</b>	Adjusts intensity of all colors.
<b>Tint</b>	Adjusts the balance between red and green levels.
<b>Color Temp .</b>	Set to warm to enhance hotter Colors such as red, or set to cool to make picture bluish.
<b>Advanced Control</b>	Customizes the advanced options. Refer to the Advanced image options. (See p.43).
<b>Picture Reset</b>	Restores the options to the default setting.



### NOTE

- If the 'Picture Mode' setting in the Picture menu is set to **Vivid, Standard, Cinema, Sport** or **Game** the subsequent menus will be automatically set.
- You cannot adjust color and tint in the RGB-PC / HDMI-PC mode.
- When using the Smart Energy Saving function, the screen may look saturated in the white area of a still image.
- If Energy Saving is set to Minimum, Medium, or Maximum, the Smart Energy Saving function is disabled.

## Advanced Control

Setting	Description
<b>Dynamic Contrast (Off/High/Medium/Low)</b>	Adjusts the contrast to keep it at the best level according to the brightness of the screen. The picture is improved by making bright parts brighter and dark parts darker. (This function can be used only under Component.)
<b>Dynamic Color (Off/High/Low)</b>	Adjusts screen Colors so that they look livelier, richer and clearer. This feature enhances hue, saturation and luminance so that red, blue, green and white look more vivid. (This function can be used only Component.)
<b>Clear White (Off/High/Low)</b>	Make the white area of screen brighter and more white.
<b>Skin Color (-5 to 5)</b>	It detects the skin area of video and adjusts it to express a natural skin color.
<b>Noise Reduction (Off/High/Medium/Low)</b>	Reduces screen noise without compromising video quality. (This function can be used only under Component.)
<b>Digital Noise Reduction (Off/High/Medium/Low)</b>	This option reduces the noise produced while creating digital video signals.
<b>Gamma (High/Medium/Low)</b>	Set your own gamma value. On the monitor, high gamma values display whitish images and low gamma values display high contrast images.
<b>Black Level (High/Low)</b>	<ul style="list-style-type: none"> <li>● Low: The picture of the screen gets darker.</li> <li>● High: The picture of the screen gets brighter.</li> </ul> Set black level of the screen to proper level. (Function works in the following mode - Component, HDMI-DTV)

## AUDIO settings

- 1 Press **MENU** to access the main menus.
- 2 Press the Navigation buttons to scroll to **AUDIO** and press **OK**.
- 3 Press the Navigation buttons to scroll to the setting or option you want and press **OK**.
  - To return to the previous level, press **BACK**.
- 4 When you are finished, press **EXIT**.  
When you return to the previous menu, press **BACK**.

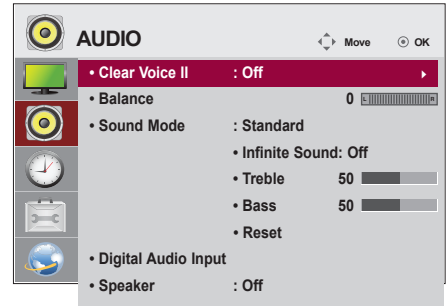

The available audio options are described in the following:

Setting	Description
<b>Clear Voice II</b>	By differentiating the human sound range from others, it helps users make dialog more clear.
<b>Balance</b>	Adjusts balance between the left and right speakers according to your room environment.
<b>Sound Mode</b>	The best sound tone quality will be selected automatically depending on the video type that you're currently watching.
<b>Mode</b>	
Standard	The most commanding and natural audio.
Music	Select this option to enjoy the original sound when listening to the music.
Cinema	Select this option to enjoy sublime sound.
Sport	Select this option to watch sports broadcasting.
Game	To enjoy dynamic sound when playing a game.
<div style="border: 1px solid black; padding: 10px; margin: 10px 0;"> <p><b>NOTE</b></p> <p>If sound quality or volume is not at the level you want, it is recommended to use a separate home theater system or amplifier to cope with different user environments.</p> </div>	
<b>Option</b>	
Infinite Sound	LG's Infinity Sound option provides 5.1 channel stereo sound from two speakers.
Treble	Controls the dominant sounds in the output. When you turn up the treble, it will increase the output to the higher frequency range.
Bass	Makes the output sound softer. When you turn up the bass, it will increase the output to the lower Frequency.
Reset	Resets the sound mode to the default setting.
<b>Digital Audio Input</b>	<b>HDMI/DisplayPort:</b> Outputs the sound of digital signal from HDMI and display ports through the monitor speaker. <b>Audio In:</b> Outputs the sound through the monitor speaker by connecting HDMI and display ports to the Audio In port.
<b>Speaker</b>	<b>ON:</b> Enables sound to the monitor speaker. (* The monitor speaker is sold separately.) <b>OFF:</b> Disables sound to the monitor speaker. Use this option when using an external sound device.



## TIME settings

- 1 Press **MENU** to access the main menus.
- 2 Press the Navigation buttons to scroll to **TIME** and press **OK**.
- 3 Press the Navigation buttons to scroll to the setting or option you want and press **OK**.
  - To return to the previous level, press **BACK**.
- 4 When you are finished, press **EXIT**.  
When you return to the previous menu, press **BACK**.

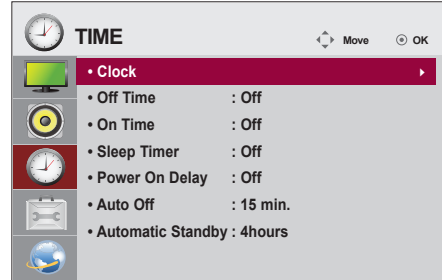

The available time settings are described in the following:

Setting	Description
<b>Clock</b>	Sets the time feature.
<b>On/Off Time</b>	Sets the time to turn on or off the Monitor set.
<b>Sleep Timer</b>	Sets the length of time until the Monitor set to turns off. When you turn the Monitor set off and turn it on again, the Sleep Timer will be set to off.
<b>Power on delay</b>	When connecting multiple monitors and turning the power on, the monitors are turned on individually to prevent overload.
<b>Auto off</b>	If Auto off is active and there is no input signal, the set switches to off mode automatically after 15 minutes.
<b>Automatic Standby</b>	If you do not use the monitor for more than 4 hours, it will be in standby mode automatically.

### ! NOTE

- Once the on or off time is set, these functions operate daily at the preset time.
- The scheduled power-off function works properly only when the device time is set correctly.
- When the scheduled power-on and power-off times are the same, the power-off time has priority over the power-on time if the set is turned on, and vice versa if the set is turned off.

## OPTION settings

- 1 Press **MENU** to access the main menus.
- 2 Press the Navigation buttons to scroll to **OPTION** and press **OK**.
- 3 Press the Navigation buttons to scroll to the setting or option you want and press **OK**.
  - To return to the previous level, press **BACK**.
- 4 When you are finished, press **EXIT**.
  - When you return to the previous menu, press **BACK**.

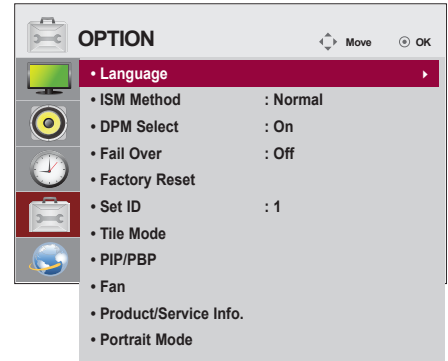

The available option settings are described in the following:

Setting	Description
<b>Language</b>	To choose the language in which the control names are displayed.
<b>ISM Method</b>	A frozen or still picture from a PC/Video game displayed on the screen for prolonged periods could result in a ghost image remaining even when you change the image. Avoid allowing a fixed image to remain on the screen for a long period of time.
<b>Setting</b>	
Normal	Leave on normal if you don't foresee image burn in being a problem.
Orbiter	May help prevent ghost images. However, it is best not to allow any fixed image to remain on the screen. To avoid a permanent image on the screen, the screen will move every 2 minutes.
Inversion	This function inverts the panel color of the screen. The panel color is automatically inverted every 30 minutes.
White Wash	White wash fills the screen with solid white. This helps removes permanent images burned into the screen. A permanent image may be impossible to clear entirely with white wash.
<b>DPM Select</b>	A user can choose to turn the power saving mode on / off.
<b>Fail Over</b>	If there is no input signal, it automatically switches to another input with signal.
<b>Setting</b>	
Off	Stops auto switch of the input source.
Auto	Switches to another input source with video signal if no video signal comes from the current input source.
Manual	Selects the priority of input source for auto switch. When several input sources are found, the input source with a higher priority will be selected.
<b>Factory Reset</b>	Select this option to return to the default factory settings.
<b>Set ID</b>	You can assign a unique Set ID NO (name assignment) to each product when several products are connected for display. Specify the number (1 to 255) using the button and exit. Use the assigned Set ID to individually control each product using the Product Control Program.

Setting	Description	
<b>Tile Mode</b>	Tile Mode	To use this function - Must be displayed with various other products. - Must be in a function that can be connected to RGB Cable by distributor and RS-232C. Tile mode and choose Tile alignment and set the ID of the current product to set location. * Only after pressing the SET button the adjustments made to the settings will be saved. - Tile mode : column x row ( c = 1 to 15 r = 1 to 15) - 15 x 15 available. - Configuration of an integration screen is also available as well as configuration of One by one Display.
	Auto Config.	Sets to adjust the screen position, clock, and phase automatically. The displayed image may be unstable for a few seconds while the configuration is in progress.
	Position	Moving the screen position horizontally and vertically.
	Size	Adjust the horizontal and vertical size of the screen taking into account the size of the bezel.
	Natural	The image is omitted by the distance between the screens to be naturally shown.
	Reset	Function to initialize and release Tile. All Tile setting are released when selecting Tile recall and the screen returns to Full screen.
<b>PIP/BPB</b>	Displays videos or photos stored in the USB device on a single monitor by dividing it into the main and sub screens.	
	<b>Option</b>	
	Mode	Sets the type of secondary screen. * <b>OFF</b> : Disables the secondary screen. * <b>PIP (Picture In Picture)</b> : Displays the secondary screen in the main screen. * <b>PBP (Picture By Picture)</b> : Displays the secondary screen next to the main screen.
	Position	Adjusts the position of the sub screen (top left, bottom left, top right, bottom right) The default value is the bottom right.
	Size	Adjusts the size of the sub screen (Size 0 to 10). The default size of PIP (Size: 0) is 480x240; the maximum size 10 is 960x540.
<div style="border: 1px solid black; padding: 10px;">  <b>NOTE</b> <ul style="list-style-type: none"> <li>• The Position and Size options are enabled only in PIP mode.</li> </ul> </div>		

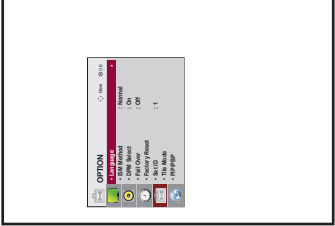
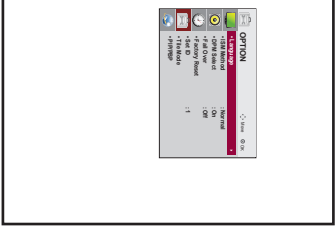
Setting	Description	
<b>Fan</b>	<b>Setting</b>	
	Mode	This option indicates the monitor's internal temperature and controls the fan. <ul style="list-style-type: none"> <li>• Auto: Switches the fan on and off according to the set temperature.</li> <li>• On: The fan is always switched on.</li> <li>• Manual: Switches the fan on and off according to user settings.</li> </ul>
	Hysteresis	The difference in temperature between when the fan is switched on and when it is off.
	Set Temperature	Set the temperature at which the fan is switched on.
	Current Temperature	Current temperature inside the set.
	<div style="border: 1px solid black; padding: 10px;"> <p><b>NOTE</b></p> <ul style="list-style-type: none"> <li>• We recommend that you use the Auto mode to prevent any malfunctions resulting from incorrect fan settings.</li> <li>• If the interior temperature of the set exceeds 80°C, the set will be turned off automatically for safety reasons.</li> </ul> </div>	
<b>Product/Service Info.</b>	Displays the model name, software version, serial number, IP address, MAC address and home page.	
<b>Portrait mode</b>	Rotate OSD clockwise (90°,270°)	
	<b>Option</b>	
	Off	Disables the Portrait mode.
	90°	Rotate OSD clockwise 90°.
	270°	Rotate OSD clockwise 270°.
<div style="display: flex; justify-content: space-around; align-items: center;"> <div style="text-align: center;">  <p>270°</p> </div> <div style="text-align: center;">  <p>90°</p> </div> </div>		

**Tile Mode**

This monitor can be tiled with additional monitors to create a large tiled display.

**Off**

When the Tile Mode option is disabled

**1X2**

When using 2 monitors

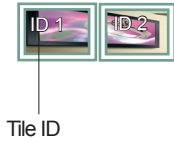

**2X2**

When using 4 monitors



**3X3**

When using 9 monitors



**4X4**

When using 16 monitors



**5X5**

When using 25 monitors



**Tile Mode - Natural mode**

When active, the part of the image that would normally be displayed in the gap between the monitors is omitted.

Before



After



**PIP/PBP**

Displays videos or photos stored in the USB device on a single monitor by dividing it into the main and sub screens. (See p.39)

**Mode**

\***PIP(Picture In Picture)**: Displays the Sub screen in the main screen.

\***PBP(Picture By Picture)**: Displays the Sub screen next to the main screen.

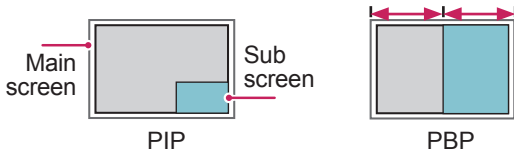

**Position**

Adjusts the position of the subscreen (top left, bottom left, top right, bottom right)

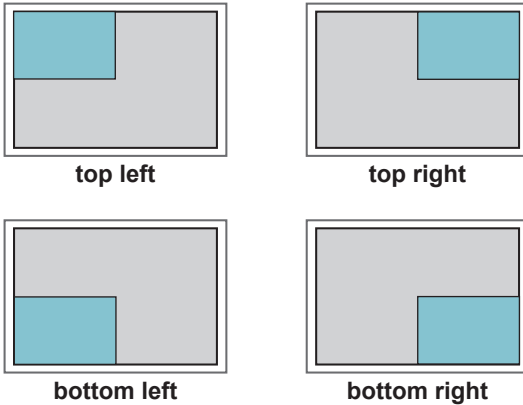

**Size**

Adjusts the size of the subscreen (Size 0-10).

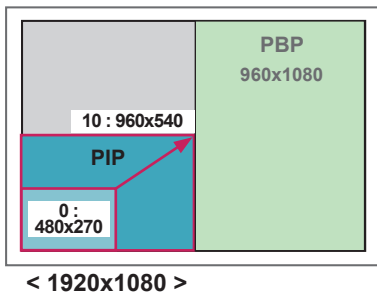

**NOTE**

- The subscreen is only supported when using the USB device.

		<b>Sub</b>
		<b>USB</b>
<b>Main</b>	<b>Component</b>	<b>O</b>
	<b>RGB</b>	<b>O</b>
	<b>HDMI/DVI-D/Display Port</b>	<b>O</b>
	<b>AV</b>	<b>X</b>

- You can only change the size and position in PIP mode.
- With PBP selected, the Aspect Ratio option in the PICTURE menu is disabled (Fixed as 16:9).
- While running the PBP function, the Tile Mode function does not work.
- You must select the output sound before running the PIP or PBP functions. (Select either Main or Sub.)
- If you fail to select Main or Sub from the sound selection box, and if the OSD disappears after either a period of time or when the Exit or Back key is pressed, the PIP/PBP subscreen is not activated.
- You cannot change the sound while running the PIP or PBP functions. If you want to change the sound, please restart PIP/PBP.
- The picture quality of the subscreen is set according to the values selected in the main menu, not the USB device.
- When the power is turned off/on, the PIP/PBP mode is disabled.
- If you play videos you selected in PIP/PBP mode, the videos will play back repeatedly in succession.
- The buttons below work in PIP mode.

Button	Photo	Movie
"<"	O	X
">"	O	X
▶	X	O
■	X	X
▶▶	X	O
◀◀	X	O
⏸	X	O

## Picture ID

Picture ID is used to change the settings of a specific display using a single IR receiver for multi-vision. The set receiving the IR signal communicates with another set via an RS232 connection. Each set is identified by a Set ID. If you assign the Picture ID using the remote control, only displays with the same Picture ID and Set ID can be controlled remotely.

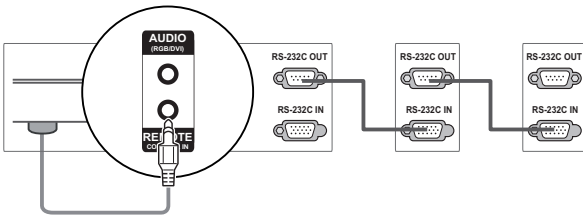

IR Receiver

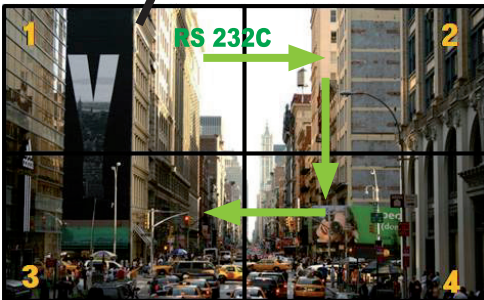

2X2 Multi-Vision (Total Set ID: 4)  
Set IDs are assigned as shown in the picture.

- 1 Press the red ON button on the remote control to assign the Picture ID.

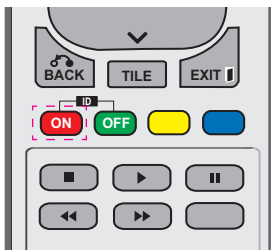

- 2 If you press the left/right buttons or press the ON button repeatedly, the Picture ID cycles through OFF and 1 to 4. Assign the ID you want.

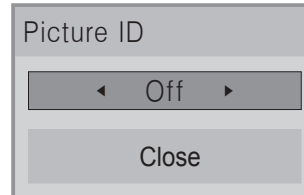

- If you assign the Set ID to each set with multi-vision, and then assign the Picture ID using the red button on the remote control, the key command is displayed for the set with the same Set ID and Picture ID. A set with different Set IDs and Picture IDs cannot be controlled by IR signals.
- For more information on how to assign the Set ID, see "Set ID" on page 46.
- The maximum value of the Picture ID can be set in the Total Set ID menu.
- Please refer to the Installation Manual for more information on Total Set ID assignment.

### NOTE

- For example, if the Picture ID is assigned to 2, the upper right display (Set ID: 2) can be controlled by IR signals.
- For each set, you can change the settings for the PICTURE, AUDIO, TIME, NETWORK and MY MEDIA menus or the hot keys on the remote control.
- If you press the green OFF button for Picture IDs, the Picture IDs for all sets are turned off. If you then press any button on the remote control, all sets will start working again.
- Picture ID will be disabled while using the MY MEDIA menu.

## NETWORK settings

- 1 Press **MENU** to access the main menus.
- 2 Press the Navigation buttons to scroll to **NETWORK** and press **OK**.
- 3 Press the Navigation buttons to scroll to the setting or option you want and press **OK**.
  - To return to the previous level, press **BACK**.
- 4 When you are finished, press **EXIT**.
  - When you return to the previous menu, press **BACK**.

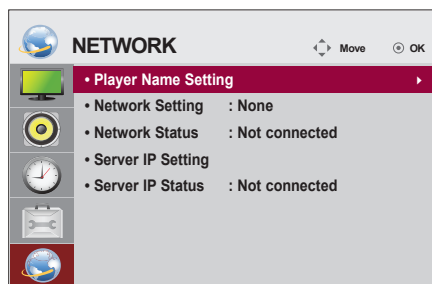

The available option settings are described in the following:

Setting	Description
<b>Player Name Setting</b>	Sets the player name used in SuperSign Manager.(Up to 20 characters)
<b>Network Setting</b>	Configure the network settings.
<b>Network Status</b>	Display the network status. - Internet is connected : Externally connected - Network is connected : Only internally connected - Not connected : When there is no network connection
<b>Server IP Setting</b>	Sets the IP address of the computer (server) on which SuperSign Manager is installed.
<b>Server IP Status</b>	Displays the connection status with the server. - Not connected : When there is no network connection with SuperSign server - Waiting for approval : When network connection with SuperSign server has been made, but access to server has not been approved by the server - Rejected : When network connection with SuperSign server has been made, but access to server has been rejected by the server - Internet is connected : When network connection with SuperSign server has been made and access to server has also been approved by the server



### CAUTION

- When setting the Player Name, input delay may occur if you press the buttons on the remote control continuously.



# MAKING CONNECTIONS

Connect various external devices to the ports on the Monitor set's back panel.

- 1 Find an external device you want to connect to your Monitor set shown on the following illustration.
- 2 Check the connection type of the external device.
- 3 Go to the appropriate illustration and check the connection details.

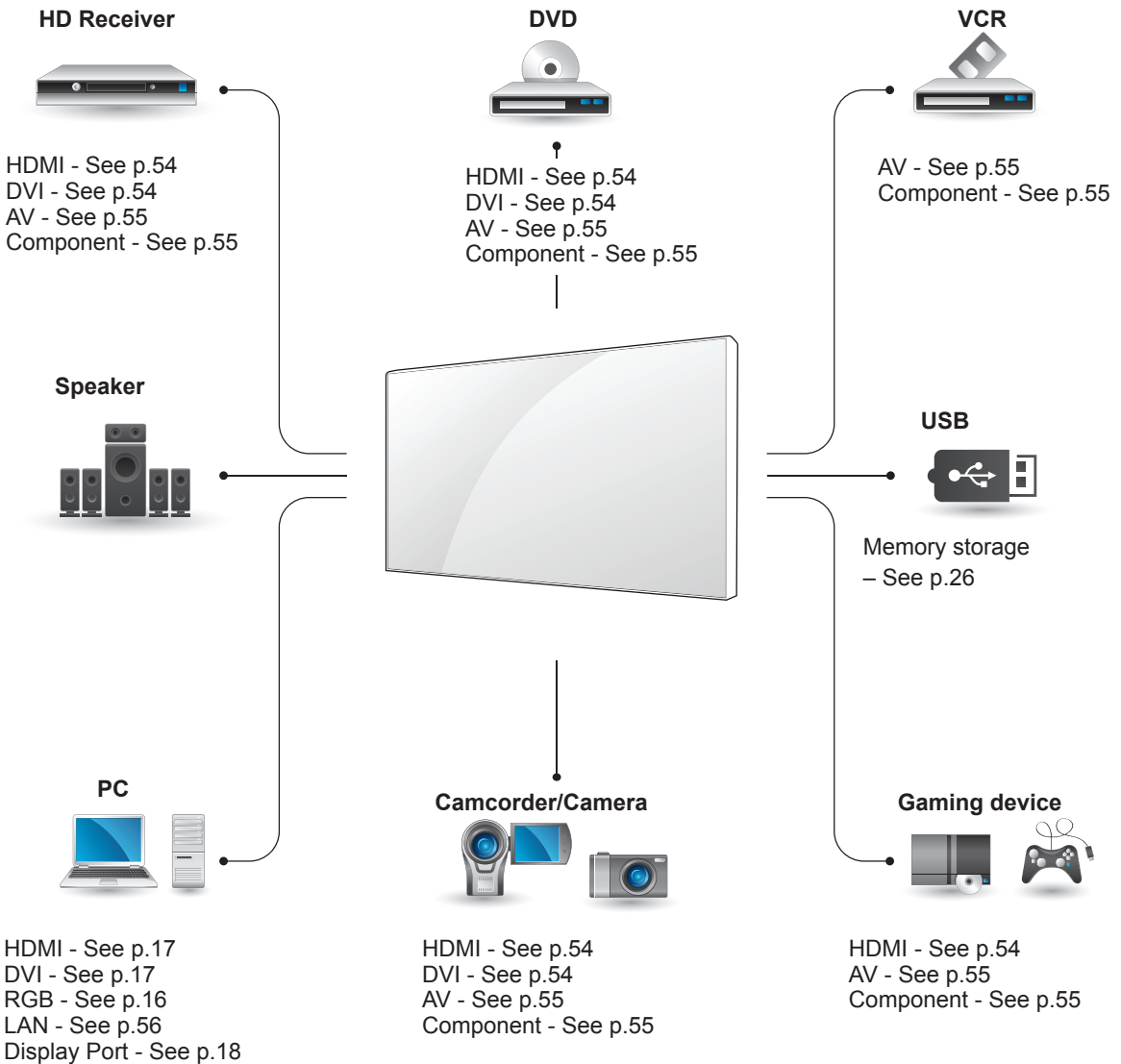

**NOTE**

- If you connect a gaming device to the Monitor set, use the cable supplied with the gaming device.

## Connecting to a HD receiver, DVD, Camcorder, Camera, Gaming Device or VCR player

Connect a HD receiver, DVD, or VCR player to the Monitor set and select an appropriate input mode.

### DVI connection

Transmits the digital video signal from an external device to the Monitor set. Connect the external device and the Monitor set with the DVI cable as shown in the following illustration. To transmit an audio signal, connect an optional audio cable.

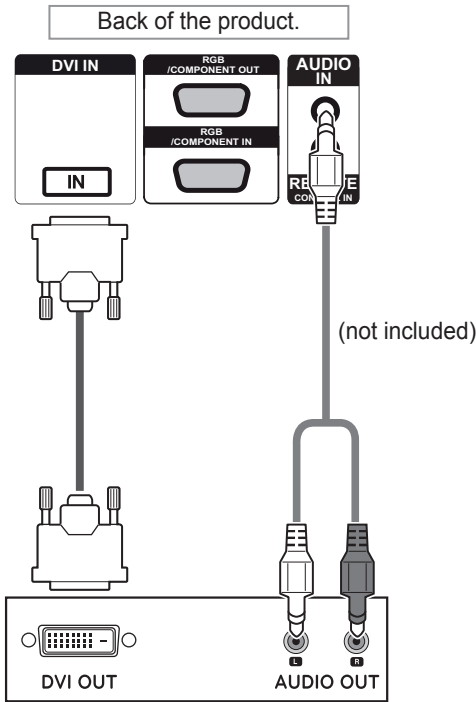

### HDMI connection

Transmits the digital video and audio signals from an external device to the Monitor set. Connect the external device and the Monitor set with the HDMI cable as shown on the following illustration.

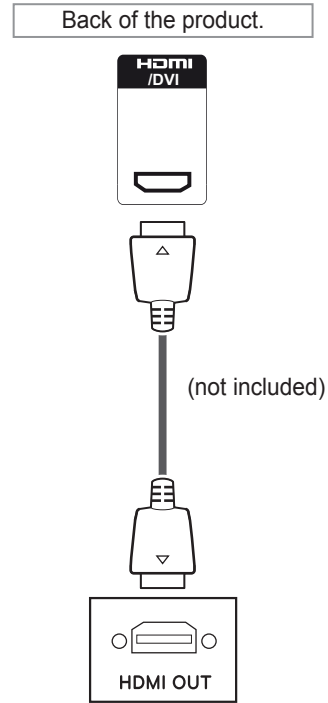

**NOTE**

- Use a High Speed HDMI™ Cable.
- High Speed HDMI™ Cables are tested to carry an HD signal up to 1080p and higher.

## Component connection

Transmits the analog video and audio signals from an external device to the Monitor set. Connect the external device and the Monitor set with the RGB-Component cable as shown in the following illustration.

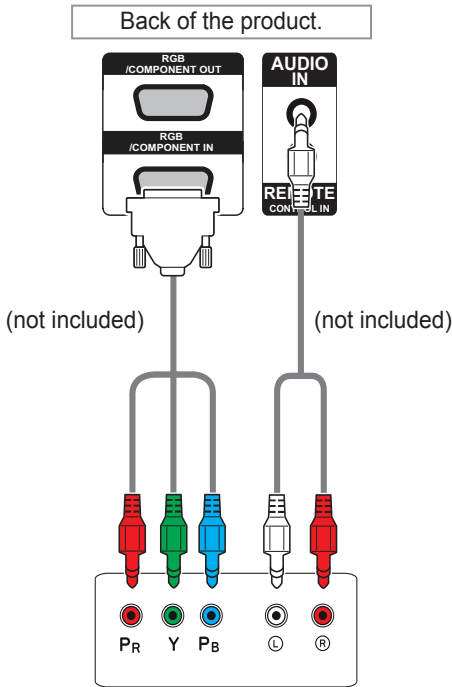

## AV(COMPOSITE,CVBS) connection

Transmits the analog video and audio signals from an external device to the Monitor set. Connect the external device and the Monitor set with the Composite cable as shown in the following illustration.

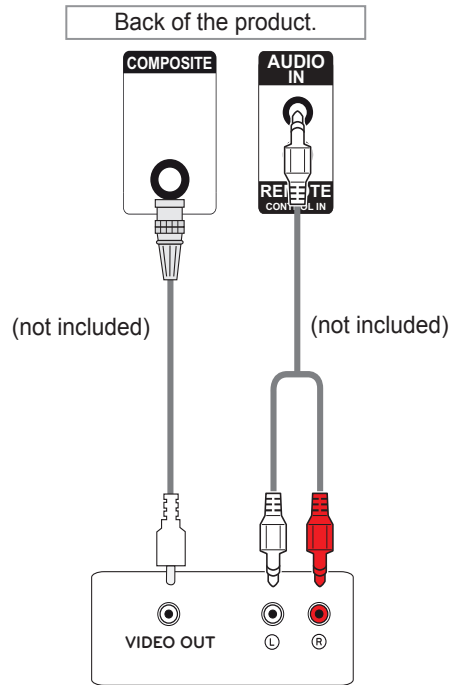

### NOTE

- When connecting to the Component port using the shared interface, the port must match up to the input source. Otherwise, noise may occur.

### NOTE

- If input signals are received through the AV cable, multiple monitors cannot be connected via the RGB OUT port.
- Input signal may be degraded or lost when multiple monitors are connected.
- For Component, in general, up to 3 monitors can be connected via the Component Out port (RGB Shared) if the signal is stable and there is no cable loss.
- If you want to connect more than this number of monitors, we recommended that you use a distributor.

## Connecting to the LAN

### LAN connection

#### A Using a router(Switch)

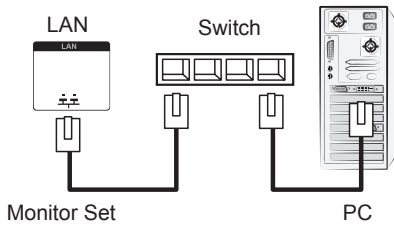

#### B Using the Internet.

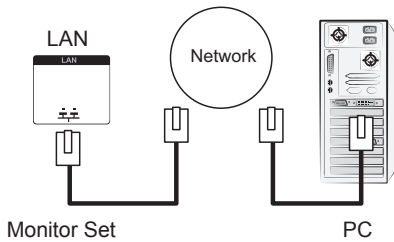

## Connecting to a USB

Connect a USB storage device such as a USB flash memory, external hard drive, MP3 player or a USB memory card reader to the Monitor set and access the USB menu to use various multimedia files.

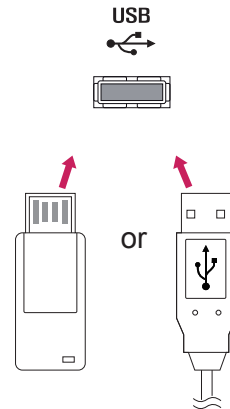

## Daisy Chain Monitors

Use this function to share the RGB video signal with other monitors without having to use a separate signal splitter box.

- To use different products connected to each other Connect one end of the signal input cable (15-pin D-Sub Signal Cable) to the RGB OUT connector of product 1 and connect the other end to the RGB IN connector of other products.

### RGB Cable

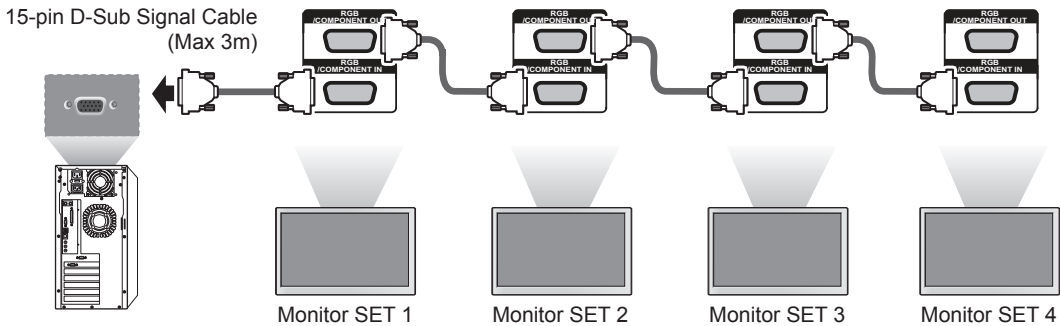

### DVI Cable

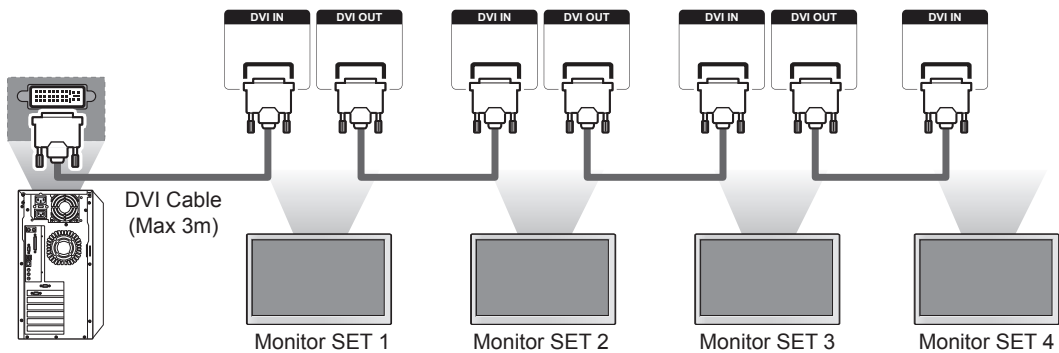

#### NOTE

- When multiple monitors are connected in RGB input, it is recommended to use a distributor to avoid signal degradation and cable loss.
- For DVI, in general, up to 12 monitors can be connected via the DVI Out port (at the recommended resolution) if the signal is stable and there is no cable loss. If you want to connect more than this number of monitors, we recommended that you use a distributor.
- When the tile mode is configured via DVI cables, only the monitor that receives first signals can play HDCP-encrypted content. (The DVI Out port does not support HDCP.)
- If the signal cable between the product and your PC is too long, make sure to use the DVI (RGB) booster or DVI (RGB) optical cable.
- If input signals are received through the HDMI/DP cable, multiple monitors cannot be connected via the DVI Out port.

# TROUBLESHOOTING

## No image is displayed

Problem	Resolution
Is the product power cord connected?	<ul style="list-style-type: none"> <li>• See if the power cord is properly connected to the outlet.</li> </ul>
Power is on, but the screen appears extremely dark.	<ul style="list-style-type: none"> <li>• Adjust brightness and contrast again.</li> <li>• Backlight may need repair.</li> </ul>
Does the 'Invalid Format' message appear?	<ul style="list-style-type: none"> <li>• The signal from the PC (video card) is out of the vertical or horizontal frequency range of the product. Adjust the frequency range by referring to the Specifications in this manual.</li> </ul> <p>* Maximum resolution            RGB : 1920 x 1080 @ 60 Hz            HDMI/DVI/DP : 1920 x 1080 @ 60 Hz</p>
Does the 'No signal' message appear?	<ul style="list-style-type: none"> <li>• The signal cable between PC and product is not connected. Check the signal cable.</li> <li>• Press the 'INPUT' menu in the remote Control to check the input signal.</li> </ul>

## 'Unknown Product' message appears when the product is connected.

Problem	Resolution
Did you install the driver?	<ul style="list-style-type: none"> <li>• See if the plug&amp;play function is supported by referring to the video card user manual.</li> </ul>

**The screen image looks abnormal.**

Problem	Resolution
Is the screen position wrong?	<ul style="list-style-type: none"> <li>• D-Sub analog signal - Press the "AUTO" button in the remote control to automatically select the optimal screen status that fits into the current mode. If adjustment is not satisfactory, use the Position OSD menu.</li> <li>• See if the video card resolution and frequency are supported by the product. If the frequency is out of range, set to the recommended resolution in the Control Panel "Display" Setting menu.</li> </ul>
Do thin lines appear on the background screen?	<ul style="list-style-type: none"> <li>• D-Sub analog signal - Press the "AUTO" button in the remote control to automatically select an optimal screen status that fits into the current mode. If adjustment is not satisfactory, use the Clock OSD menu.</li> </ul>
Horizontal noise appears or the characters look blurred.	<ul style="list-style-type: none"> <li>• D-Sub analog signal - Press the "AUTO" button in the remote control to automatically select an optimal screen status that fits into the current mode. If adjustment is not satisfactory, use the Phase OSD menu.</li> </ul>
The screen is displayed abnormally.	<ul style="list-style-type: none"> <li>• The proper input signal is not connected to the signal port. Connect the signal cable that matches with the source input signal.</li> </ul>

**After-image appears on the product.**

Problem	Resolution
After-image appears when the product is turned off.	<ul style="list-style-type: none"> <li>• If you use a fixed image for a long time, the pixels may be damaged quickly. Use the screen-saver function.</li> </ul>

**The audio function does not work.**

Problem	Resolution
No sound?	<ul style="list-style-type: none"> <li>• See if the audio cable is connected properly.</li> <li>• Adjust the volume.</li> <li>• See if the sound is set properly.</li> </ul>
Sound is too dull.	<ul style="list-style-type: none"> <li>• Select the appropriate equalize sound.</li> </ul>
Sound is too low.	<ul style="list-style-type: none"> <li>• Adjust the volume.</li> </ul>

**Screen color is abnormal.**

Problem	Resolution
Screen has poor color resolution (16 colors).	<ul style="list-style-type: none"> <li>Set the number of colors to more than 24 bits (true color) Select Control Panel - Display - Settings - Color Table menu in Windows.</li> </ul>
Screen color is unstable or mono-colored.	<ul style="list-style-type: none"> <li>Check the connection status of the signal cable. Or, re-insert the PC video card.</li> </ul>
Do black spots appear on the screen?	<ul style="list-style-type: none"> <li>Several pixels (red, green, white or black color) may appear on the screen, which can be attributable to the unique characteristics of the LCD panel. It is not a malfunction of the LCD.</li> </ul>

**The operation does not work normally.**

Problem	Resolution
The power suddenly turned off.	<ul style="list-style-type: none"> <li>Is the sleep timer set?</li> <li>Check the power control settings. Power interrupted.</li> </ul>



# SPECIFICATIONS

LCD Panel	Screen Type	1387.80 mm Wide (55 inch) TFT (Thin Film Transistor) LCD (Liquid Crystal Display) Panel. Visible diagonal size : 1387.80 mm
	Pixel Pitch	0.630 mm (H) x 0.630 mm (V)
Video Signal	Max. Resolution	RGB : 1920 x 1080 @ 60 Hz HDMI/DVI/DP : 1920 x 1080 @ 60 Hz - It may not be supported depending on the OS or video card type.
	Recommended Resolution	RGB : 1920 x 1080 @ 60 Hz HDMI/DVI/DP : 1920 x 1080 @ 60 Hz - It may not be supported depending on the OS or video card type.
	Horizontal Frequency	RGB : 30 kHz to 83 kHz HDMI/DVI/DP : 30kHz to 83 kHz
	Vertical Frequency	RGB : 56 Hz to 60 Hz HDMI/DVI/DP : 56 Hz to 60 Hz
	Synchronization Type	Separate Sync, Composite(AV) Sync, Digital, SOG
Input Connector	15-pin D-Sub type (RGB / Component ), HDMI/DVI/DP(digital), Composite(AV), RS-232C, LAN, USB	
Power	Rated Voltage	AC 100-240 V~, 50 / 60 Hz 3.3 A
	Power Consumption	
	55WV70MS	On Mode : 210 W Typ. Smart Energy Saving Mode : 120 W Typ. Off Mode : ≤ 0.5 W
	55WV70BS	On Mode : 160 W Typ. Smart Energy Saving Mode : 90 W Typ. Off Mode : ≤ 0.5 W
Dimensions (Width x Height x Depth) / Weight	<p>* Wall Bracket available VESA 600 x 400</p>	
	1215.2 mm X 686 mm X 99 mm / 33.4 Kg	
Environmental conditions	Operating Temperature	0 °C to 40 °C
	Operating Humidity	10 % to 80 %
	Storage Temperature	-20 °C to 60 °C
	Storage Humidity	5 % to 95 %

## \* Applicable only for models that support the speakers

Audio	RMS Audio Output	10 W + 10 W (R + L)
	Input Sensitivity	0.7 Vrms
	Speaker Impedance	8 Ω

Product specifications shown above may be changed without prior notice due to upgrade of product functions.

**RGB (PC) supported mode**

Resolution	Horizontal Frequency(kHz)	Vertical Frequency(Hz)
640 x 480	31.469	59.94
1024 x 768	48.363	60
1280 x 720	44.772	59.855
1366 x 768	47.7	60
1680 x 1050	65.290	59.954
1920 x 1080	67.5	60

**HDMI/DVI/Display Port(PC) supported mode**

Resolution	Horizontal Frequency(kHz)	Vertical Frequency(Hz)
640 x 480	31.469	59.94
800 x 600	37.879	60.317
1024 x 768	48.363	60
1280 x 720	44.772	59.855
1280 x 768	47.7	60
1366 x 768	47.7	60
1280 x 1024	63.981	60.02
1680 x 1050	65.290	59.954
1920 x 1080	67.5	60

**DTV Mode**

Resolution	Component	HDMI/DVI (DTV)
480i	o	x
576i	o	x
480p	o	o
576p	o	o
720p	o	o
1080i	o	o
1080p	o	o

**! NOTE**

- PC resolutions available as the input label option in RGB and HDMI/DVI input mode : 640 x 480 / 60 Hz, 1280 x 720 / 60 Hz, 1920 x 1080 / 60 Hz and DTV resolutions : 480p, 720p, 1080p.

**! NOTE**

- Vertical frequency: To enable the user to watch the product display, screen image should be changed tens of times every second like a fluorescent lamp. The vertical frequency or refresh rate is the times of image display per second. The unit is Hz.
- Horizontal frequency: The horizontal interval is the time to display one vertical line. When 1 is divided by the horizontal interval, the number of horizontal lines displayed every second can be tabulated as the horizontal frequency. The unit is kHz.

# IR CODES

- All models do not support the HDMI/USB function.

Code (Hexa)	Function	Note
95	Energy Saving (e0)	R/C BUTTON
08	⏻ POWER	R/C BUTTON (ON/OFF)
0B	INPUT	R/C BUTTON
C4	Monitor On	R/C BUTTON
C5	Monitor Off	R/C BUTTON
43	MENU	R/C BUTTON
40	Up (^)	R/C BUTTON
41	Down (v)	R/C BUTTON
07	Left (<)	R/C BUTTON
06	Right (>)	R/C BUTTON
44	OK(⊙)	R/C BUTTON
28	BACK(↶)	R/C BUTTON
5B	EXIT	R/C BUTTON
4D	PSM	R/C BUTTON
02	Volume ▲ ( + )	R/C BUTTON
03	Volume ▼ ( - )	R/C BUTTON
09	MUTE	R/C BUTTON
E0	Bright ^ (Page UP)	R/C BUTTON
E1	Bright v (Page Down)	R/C BUTTON
10 to 19	Number Key 0 to 9	R/C BUTTON
72	Red Key (ID ON)	R/C BUTTON
71	Green Key (ID OFF)	R/C BUTTON
63	Yellow Key	R/C BUTTON
61	Blue Key	R/C BUTTON
7B	TILE	R/C BUTTON
76	ARC (4:3)	R/C BUTTON
77	ARC (16:9)	R/C BUTTON
AF	ARC (ZOOM)	R/C BUTTON
79	ARC (MARK)	R/C BUTTON
99	Auto Config.	R/C BUTTON
B1	■	R/C BUTTON
B0	▶	R/C BUTTON
BA		R/C BUTTON
8F	◀◀	R/C BUTTON
8E	▶▶	R/C BUTTON

# CONTROLLING THE MULTIPLE PRODUCT

- Use this method to connect several products to a single PC. You can control several products at one time by connecting them to a single PC.
- In the Option menu, Set ID must be between 1 and 255 without being duplicated.

## Connecting the cable

Connect the RS-232C cable as shown in the picture.

- The RS-232C protocol is used for communication between the PC and product. You can turn the product on/off, select an input source or adjust the OSD menu from your PC.

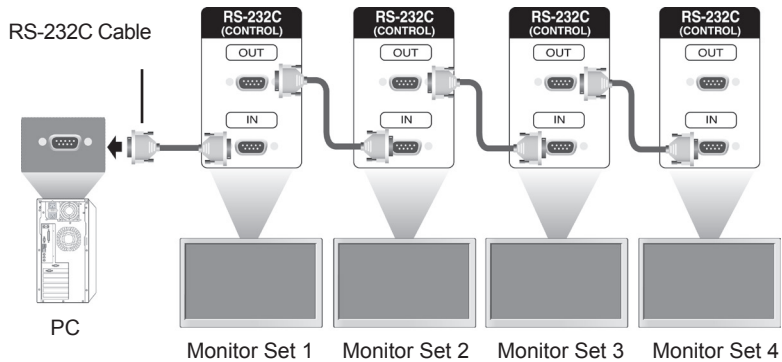

## RS-232C Configurations

### 8-Wire Configurations (Cross-over RS-232C cable)

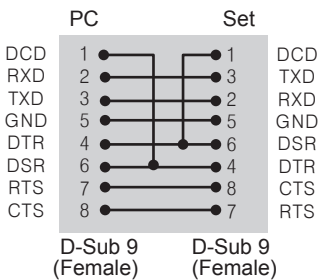

### NOTE

- When using 3-wire connections (non-standard), an IR daisy chain cannot be used.

## Communication Parameter

- Baud Rate : 9600 buad Rate (UART)
- Data Length : 8 bit
- Parity Bit : None
- Stop Bit : 1bit
- Flow Control : None
- Communication Code : ASCII code
- Use a crossed (reverse) cable

## Command reference list

	COMMAND		DATA (Hexadecimal)
	1	2	
01. Power	k	a	00H to 01H
02. Input Select	x	b	Refer to '02. Input Select'
03. Aspect Ratio	k	c	Refer to '03. Aspect Ratio'
04. Energy Saving	j	q	Refer to '04. Energy Saving'
05. Picture mode	d	x	00H to 04H
06. Contrast	k	g	00H to 64H
07. Brightness	k	h	00H to 64H
08. Sharpness	k	k	00H to 64H
09. Color	k	i	00H to 64H
10. Tint	k	j	00H to 64H
11. Color Temperature	x	u	00H to 64H
12. H Position	f	q	00H to 64H
13. V Position	f	r	00H to 64H
14. H Size	f	s	00H to 64H
15. Auto configuration	j	u	01H
16. Balance	k	t	00H to 64H
17. Sound mode	d	y	01H to 05H
18. Treble	k	r	00H to 64H
19. Bass	k	s	00H to 64H
20. Speaker	d	v	00H to 01H
21. Volume Mute	k	e	00H to 01H
22. Volume Control	k	f	00H to 64H
23. Time 1(Years/ Months/ Days)	f	a	Refer to '23. Time 1'
24. Time 2(Hours/ Minutes/Seconds)	f	x	Refer to '24. Time 2'
25. Off Timer(Repeat mode/ Time)	f	e	Refer to '25. Off Timer'
26. On Timer(Repeat Mode/ Time)	f	d	Refer to '26. On Timer'
27. On Timer Input	f	u	Refer to '27. On Timer Input'
28. Sleep Time	f	f	00H to 08H
29. Power On Delay	f	h	00H to 64H
30. Automatic Standby	m	n	00H to 01H
31. Auto Off	f	g	00H to 01H
32. Language	f	i	00H to 0AH
33. ISM mode	j	p	Refer to '33. ISM Method'
34. DPM Select	f	j	00H to 01H
35. Fail Over Select	m	i	00H to 02H
36. Fail Over Input Select	m	j	Refer to '36. Fail Over Input Select'
37. Reset	f	k	00H to 03H
38. Tile Mode	d	d	Refer to '38. Tile Mode'
39. Tile Mode Check	d	z	FFH
40. Tile ID	d	i	Refer to '40. Tile ID'

	COMMAND		DATA (Hexadecimal)
	1	2	
41. Tile H Position	d	e	00H to 32H
42. Tile V Position	d	f	00H to 32H
43. Tile H Size	d	g	00H to 32H
44. Tile V Size	d	h	00H to 32H
45. Natural Mode (In Tile mode)	d	j	00H to 01H
46. Auto Switch Input Select	d	o	00H to 01H
47. FAN Fault check	d	w	FFH
48. Temperature Value	d	n	FFH
49. Key	m	c	Refer to '49. Key'
50. OSD Select	k	l	00H to 01H
51. Elapsed time return	d	l	FFH
52. Serial No. Check	f	y	FFH
53. S/W Version	f	z	FFH
54. White Balance Red Gain	j	m	00H to FEH
55. White Balance Green Gain	j	n	00H to FEH
56. White Balance Blue Gain	j	o	00H to FEH

- Note : During USB operations such as Dvix or EMF, all commands except Power(ka) and Key(mc) are not executed and treated as NG.

## Transmission / Receiving protocol

### Transmission

[Command1][Command2][ ][Set ID][ ][Data][Cr] or  
 [Command1][Command2][ ][Set ID][ ][Data1][ ][Data2][ ][Data3][Cr] or  
 [Command1][Command2][ ][Set ID][ ][Data1][ ][Data2][ ][Data3][ ][Data4][Cr]

- \* [Command1]: First command to control the set.
- \* [Command2]: Second command to control the set.
- \* [Set ID]: Set ID with which you want to communicate. Ether [Set ID] = '00(0x00)' to communicate with all sets regardless of their Set ID numbers.
- \* [Data]: Information passed to the set.
- \* [Data1]: Information passed to the set.
- \* [Data2]: Information passed to the set.
- \* [Data3]: Information passed to the set.
- \* [Cr]: Carriage Return. ASCII code '0x0D'.
- \* [ ]: ASCII code space '0x20'

### Acknowledgement

[Command2][ ][Set ID][ ][OK/NG][Data][x] or  
 [Command2][ ][Set ID][ ][OK/NG][Data1][Data2][Data3][x] or  
 [Command2][ ][Set ID][ ][OK/NG][Data1][Data2][Data3][Data4][x]

- \* In a like manner, if other functions transmit 'FF' data based on this format, Acknowledgement data feedback presents status about each function.
- \* Note: In this mode, display will send the acknowledgement after power on processing completion. There might be a time delay between command and acknowledgement.
- \* No acknowledgement signal will be sent from display, if Set ID in transmission signal is set to '00'(=0x00).

**01. Power (Command: k a)**

To control power On/Off the display.

**Transmission**

[k][a][ ][Set ID][ ][Data][Cr]

Data 00 : Power Off

01 : Power On

FF : Check status

**Acknowledgement**

[a][ ][Set ID][ ][OK/NG][Data][x]

\* In a like manner, if other functions transmit 'FF' data based on this format, Acknowledgement data feedback presents status about each function.

\* Note: In this modes, display will send the acknowledgement after power on processing completion. There might be a time delay between command and acknowledgement.

\* There might be some time delays between command and acknowledgement.

**02. Input Select (Command: x b)**

To select input source for display.

**Transmission**

[x][b][ ][Set ID][ ][Data][Cr]

Data 20: AV

40: Component

60: RGB PC

70: DVI-D(PC)

80: DVI-D(DTV)

90: HDMI(DTV)

A0: HDM(PC)

C0: Display Port(PC)

D0: Display Port(DTV)

**Acknowledgement**

[b][ ][Set ID][ ][OK/NG][Data][x]

**03. Aspect Ratio (Command: k c)**

To adjust the screen format.

**Transmission**

[k][c][ ][Set ID][ ][Data][Cr]

Data 01: 4:3

02: 16:9

04: Zoom

09: Just scan(720p or more)

10 to 1F: Cinema Zoom 1 to 16

**Acknowledgement**

[c][ ][Set ID][ ][OK/NG][Data][x]

**04. Energy Saving (Command: j q)**

To control the energy saving function.

**Transmission**

[j][q][ ][Set ID][ ][Data][Cr]

Data 00: Off

01: Minimum

02: Medium

03: Maximum

05: Screen Off

**Acknowledgement**

[q][ ][Set ID][ ][OK/NG][Data][x]

**05. Picture Mode (Command: d x)**

To select the picture mode.

**Transmission**

[d][x][ ][Set ID][ ][Data][Cr]

Data 00: Vivid

01: Standard

02: Cinema

03: Sport

04: Game

**Acknowledgement**

[x][ ][Set ID][ ][OK/NG][Data][x]

**06. Contrast (Command: k g)**

To adjust screen contrast.

**Transmission**

[k][g][ ][Set ID][ ][Data][Cr]

Data 00 to 64: Contrast 0 to 100

**Acknowledgement**

[g][ ][Set ID][ ][OK/NG][Data][x]



**07. Brightness (Command: k h)**

To adjust screen brightness.

Transmission

`[k][h][ ][Set ID][ ][Data][Cr]`

Data 00 to 64: Brightness 0 to 100

Acknowledgement

`[h][ ][Set ID][ ][OK/NG][Data][x]`**10. Tint (Command: k j) (Video Timing only)**

To adjust screen tint.

Transmission

`[k][j][ ][Set ID][ ][Data][Cr]`

Data 00 to 64: Tint R50 to G50

Acknowledgement

`[j][ ][Set ID][ ][OK/NG][Data][x]`**08. Sharpness (Command: k k) (Video Timing only)**

To adjust screen sharpness.

Transmission

`[k][k][ ][Set ID][ ][Data][Cr]`

Data 00 to 64: Sharpness 0 to 100

Acknowledgement

`[k][ ][Set ID][ ][OK/NG][Data][x]`**11. Color Temperature (Command: x u)**

To adjust color temperature.

Transmission

`[x][u][ ][Set ID][ ][Data][Cr]`

Data 00 to 64: Warm 50 to Cool 50

Acknowledgement

`[u][ ][Set ID][ ][OK/NG][Data][x]`**09. Color (Command: k i) (Video Timing only)**

To adjust screen color.

Transmission

`[k][i][ ][Set ID][ ][Data][Cr]`

Data 00 to 64: Color 0 to 100

Acknowledgement

`[i][ ][Set ID][ ][OK/NG][Data][x]`**12. H Position (Command: f q)**

To set the Horizontal position.

\* Only available for Tile Off mode.

Transmission

`[f][q][ ][Set ID][ ][Data][Cr]`

Data 00 to 64: Left -50 to Right 50

Acknowledgement

`[q][ ][Set ID][ ][OK/NG][Data][x]`

**13. V Position (Command: f r)**

To set the Vertical position.

\* Only available for Tile Off mode.

Transmission

[f][r][ ][Set ID][ ][Data][Cr]

Data 00 to 64: Bottom Max(-50) to Top Max(50)

\* The operational range varies depending on the RGB input resolution.

Acknowledgement

[r][ ][Set ID][ ][OK/NG][Data][x]

**14. H Size (Command: f s)**

To set the Horizontal size.

\* Only available for Tile Off mode.

Transmission

[f][s][ ][Set ID][ ][Data][Cr]

Data 00 to 64: Size -50 to 50

Acknowledgement

[s][ ][Set ID][ ][OK/NG][Data][x]

**15. Auto Configuration (Command: j u)**

To adjust picture position and minimize image shaking automatically.

\* Only available for RGB input.

Transmission

[j][u][ ][Set ID][ ][Data][Cr]

Data 01 : Set

Acknowledgement

[u][ ][Set ID][ ][OK/NG][Data][x]

**16. Balance (Command: k t)**

To adjust balance.

Transmission

[k][t][ ][Set ID][ ][Data][Cr]

Data 00 to 64: Left 50 to Right 50

Acknowledgement

[t][ ][Set ID][ ][OK/NG][Data][x]

**17. Sound Mode (Command: d y)**

To select the sound mode.

Transmission

[d][y][ ][Set ID][ ][Data][Cr]

Data 01: Standard

02: Music

03: Cinema

04: Sport

05: Game

Acknowledgement

[y][ ][Set ID][ ][OK/NG][Data][x]

**18. Treble (Command: k r)**

To adjust treble.

Transmission

[k][r][ ][Set ID][ ][Data][Cr]

Data 00 to 64: Treble 0 to 100

Acknowledgement

[r][ ][Set ID][ ][OK/NG][Data][x]

**19. Bass (Command: k s)**

To adjust bass.

**Transmission****[k][s][ ][Set ID][ ][Data][Cr]**

Data 00 to 64: Bass 0 to 100

**Acknowledgement****[s][ ][Set ID][ ][OK/NG][Data][x]****20. Speaker (Command: d v)**

To select speaker on/off.

**Transmission****[d][v][ ][Set ID][ ][Data][Cr]**

Data 00: Speaker Off

01: Speaker On

**Acknowledgement****[v][ ][Set ID][ ][OK/NG][Data][x]****21. Volume Mute (Command: k e)**

To select screen mute on/off.

**Transmission****[k][e][ ][Set ID][ ][Data][Cr]**

Data 00 : Volume Mute On (Volume Off)

01 : Volume Mute Off (Volume On)

**Acknowledgement****[e][ ][Set ID][ ][OK/NG][Data][x]****22. Volume Control (Command: k f)**

To adjust volume.

**Transmission****[k][f][ ][Set ID][ ][Data][Cr]**

Data 00 to 64: Volume 0 to 100

**Acknowledgement****[f][ ][Set ID][ ][OK/NG][Data][x]****23. Time 1 (Year/ Month/ Day) (Command: f a)**

To set the Time 1 (Year/ Month/ Day) values.

**Transmission****[f][a][ ][Set ID][ ][Data1][ ][Data2][ ][Data3][Cr]**

Data 1 00 to 14: 2010 to 2030

Data 2 01 to 0C: January to December

Data 3 01 to 1F: 1 to 31

\* Enter "fa [Set ID] ff" for checking Time 1 values.

**Acknowledgement****[a][ ][Set ID][ ][OK/NG][Data1][Data2][Data3][x]****24. Time 2 (Hour/ Minute/ Second) (Command: f x)**

To set the Time 2 (Hour/ Minute/ Second) values.

**Transmission****[f][x][ ][Set ID][ ][Data1][ ][Data2][ ][Data3][Cr]**

Data1 00 to 17: 00 to 23 hours

Data2 01 to 3B: 00 to 59 minutes

Data3 01 to 3B: 00 to 59 seconds

\* Enter "fx [Set ID] ff" for checking Time 2 values.

\*\* This command won't work if Time 1 has not been set in advance.

**Acknowledgement****[x][ ][Set ID][ ][OK/NG][Data1][Data2][Data3][x]**

**25. Off Timer(Repeat Mode/ Time) (Command: f e)**

To set the Off Timer(Repeat mode/ Time) function.

**Transmission**

[f][e][ ][Set ID][ ][Data1][ ][Data2][ ][Data3][Cr]

Data1 00: Repeat Off  
 01: Repeat Once  
 02: Repeat Daily  
 03: Repeat from Monday to Friday  
 04: Repeat from Monday to Saturday  
 05: Repeat from Saturday to Sunday  
 06: Repeat on Sunday

Data2 01 to 17: 00 to 23 Hours

Data3 01 to 3B: 00 to 59 Minutes

\* Enter "fe [Set ID] ff" for checking Off Timer(Repeat mode/ Time) values.

\* Check if Time1 and Time2 have been set before setting this function.

**Acknowledgement**

[e][ ][Set ID][ ][OK/NG][Data1][Data2][Data3][x]

**26. On Timer(Repeat Mode/ Time) (Command: f d)**

To set the On Timer(Repeat mode/ Time) function.

**Transmission**

[f][d][ ][Set ID][ ][Data1][ ][Data2][ ][Data3][Cr]

Data1 00: Repeat Off  
 01: Repeat Once  
 02: Repeat Daily  
 03: Repeat from Monday to Friday  
 04: Repeat from Monday to Saturday  
 05: Repeat from Saturday to Sunday  
 06: Repeat on Sunday

Data2 01 to 17: 00 to 23 Hours

Data3 01 to 3B: 00 to 59 Minutes

\* Enter "fd [Set ID] ff" for checking On Timer(Repeat mode/ Time) values.

\* Check if Time1 and Time2 have been set before setting this function.

**Acknowledgement**

[d][ ][Set ID][ ][OK/NG][Data1][Data2][Data3][x]

**27. On Timer Input (Command: f u)**

To set the On Timer Input function.

**Transmission**

[f][u][ ][Set ID][ ][Data][Cr]

Data 20: AV  
 40: Component  
 60: RGB  
 70: DVI  
 90: HDMI  
 C0: Display Port

\* Check if Time1, Time2, and On Timer(Repeat Mode/ Time) functions have been set before setting this function.

\* On Timer(Repeat Mode/ Time) command should be executed in advance this command to set On Timer schedule properly.

**Acknowledgement**

[u][ ][Set ID][ ][OK/NG][Data][x]

**28. Sleep Time (Command: f f)**

To set sleep time.

**Transmission**

[f][f][ ][Set ID][ ][Data][Cr]

Data 00: Off  
 01: 10 min.  
 02: 20 min.  
 03: 30 min.  
 04: 60 min.  
 05: 90 min.  
 06: 120 min.  
 07: 180 min.  
 08: 240 min.

**Acknowledgement**

[f][ ][Set ID][ ][OK/NG][Data][x]

**29. Power On Delay (Command: f h)**

To set the schedule delay when the power is turned on(unit: second).

**Transmission**

[f][h][ ][Set ID][ ][Data][Cr]

Data 00 to 64: 0 to 100sec.

**Acknowledgement**

[h][ ][Set ID][ ][OK/NG][Data][x]

**30. Automatic Standby (Command: m n)**

To set the Automatic Standby function.

Transmission

[m][n][ ][Set ID][ ][Data][Cr]

Data 00: Off

01: 4 Hours Off

Acknowledgement

[n][ ][Set ID][ ][OK/NG][Data][x]

**31. Auto Off (Command: f g)**

To set the Auto Off function.

Transmission

[f][g][ ][Set ID][ ][Data][Cr]

Data 00: Auto Off Off

01: Auto Off On

Acknowledgement

[g][ ][Set ID][ ][OK/NG][Data][x]

**32. Language (Command: f i)**

To set language for OSD.

Transmission

[f][i][ ][Set ID][ ][Data][Cr]

Data 00: Czech

01: Danish

02: German

03: English

04: Spanish(EU)

05: Greek

06: French

07: Italian

08: Dutch

09: Norwegian

0A: Portuguese

0B: Portuguese(BR)

0C: Russian

0D: Finnish

0E: Swedish

0F: Korean

10: Chinese (Mandarin)

11: Japanese

12: Yue Chinese(Cantonese)

Acknowledgement

[i][ ][Set ID][ ][OK/NG][Data][x]

**33. ISM mode (Command: j p)**

To select ISM method for avoiding having a fixed image remain on screen.

Transmission

[j][p][ ][Set ID][ ][Data][Cr]

Data 01: Inversion

02: Orbiter

04: White Wash

08: Normal

Acknowledgement

[p][ ][Set ID][ ][OK/NG][Data][x]

**34. DPM Select (Command: f j)**

To set the DPM (Display Power Management) function.

Transmission

[f][j][ ][Set ID][ ][Data][Cr]

Data 00: DPM Select Off

01: DPM Select On

Acknowledgement

[j][ ][Set ID][ ][OK/NG][Data][x]

**35. Fail Over Select (Command: m i)**

To set the Fail Over function.

Transmission

[m][i][ ][Set ID][ ][Data][Cr]

Data 00: Off

01: Auto

02: Manual

Acknowledgement

[i][ ][Set ID][ ][OK/NG][Data][x]

**36. Fail Over Input Select (Command: m j)**

To select fail over mode.

\*Only available in Fail Over manual mode.

**Transmission**

[m][j][ ][Set ID][ ][Data1][ ][Data2][ ][Data3][Cr]

Data Data1 to 4(Priority 1 to 3)

60: RGB

70: DVI-D\*

90: HDMI\*\*

C0: Display Port\*\*\*

\* Use 0x70 as data for DVI-D input, regardless DVI-D(PC) or DVI-D(DTV).

\*\* Use 0x90 as data for HDMI input, regardless HDMI-DTV or HDMI-PC

\*\*\* Use 0xC0 as data for Display Port input, regardless Display Port(DTV) or Display Port(PC)

**Acknowledgement**

[j][ ][Set ID][ ][OK/NG][Data1][Data2][Data3][x]

Data1 to 3(Priority 1 to 3)

60: RGB

70: DVI-D\*\*\*\*

90: HDMI\*\*\*\*\*

C0: Display Port\*\*\*\*\*

\*\*\*\* Returns 0x70 as Data for DVI-D port, regardless DVI-D(PC) or DVI-D(DTV).

\*\*\*\*\* Returns 0x90 as Data for HDMI port, regardless HDMI-DTV or HDMI-PC.

\*\*\*\*\* Returns 0xC0 as Data for Display Port, regardless Display Port(DTV) or Display Port(PC).

**37. Reset (Command: f k)**

To execute the Picture, Screen, Audio and Factory reset function.

**Transmission**

[f][k][ ][Set ID][ ][Data][Cr]

Data 00: Picture Reset

01: Screen Reset

02: Audio Reset

03: Factory Reset

**Acknowledgement**

[k][ ][Set ID][ ][OK/NG][Data][x]

**38. Tile Mode (Command: d d)**

To select a Tile Mode Off/ On and Tile Row/ Column size.

**Transmission**

[d][d][ ][Set ID][ ][Data][Cr]

Data 00 to FF: 1st byte - Tile Row value

2nd byte - Tile Column value

\*00, 01, 10, 11 means Tile Mode Off.

**Acknowledgement**

[d][ ][Set ID][ ][OK/NG][Data][x]

**39. Tile Mode Check (Command: d z)**

To check Tile Mode status.

**Transmission**

[d][z][ ][Set ID][ ][Data][Cr]

Data FF: Check Tile Mode status

**Acknowledgement**

[z][ ][Set ID][ ][OK/NG][Data1][Data2][Data3][x]

Data1 00: Tile Mode Off

01: Tile Mode On

Data2 00 to 0F: Tile Row Value

Data3 00 to 0F: Tile Col Value

**40. Tile ID (Command: d i)**

To set Tile ID.

**Transmission**

[d][i][ ][Set ID][ ][Data][Cr]

Data 01 to E1: Tile ID 01 to 225\*\*

FF: Read Tile ID

\*\* Data could not be set over (Tile Row) x (Tile Column)

**Acknowledgement**

[i][ ][Set ID][ ][OK/NG][Data][x]

**41. Tile H Position (Command: d e)**

To set the Tile Horizontal position.

\*Only available when Tile Natural Mode is off.

Transmission

[d][e][ ][Set ID][ ][Data][Cr]

Data 00 to 32: Left (-50) to Right (0)

Acknowledgement

[e][ ][Set ID][ ][OK/NG][Data][x]

**44. Tile V Size (Command: d h)**

To set the Tile Vertical size.

\*Set Tile V Position to 0x00 before setting Tile V Size.

\*Only available when Tile Natural Mode is off.

Transmission

[d][h][ ][Set ID][ ][Data][Cr]

Data 00 to 32: 0 to 50

Acknowledgement

[h][ ][Set ID][ ][OK/NG][Data][x]

**42. Tile V Position (Command: d f)**

To set the Tile Vertical position.

\*Only available when Tile Natural Mode is off.

Transmission

[d][f][ ][Set ID][ ][Data][Cr]

Data 0 to 32: Bottom (0) to Top (50)

(\*Bottom/Top values depend on Tile V size.)

Acknowledgement

[f][ ][Set ID][ ][OK/NG][Data][x]

**45. Natural Mode (In Tile Mode) (Command: d j)**

To set the Tile Natural mode.

Transmission

[d][j][ ][Set ID][ ][Data][Cr]

Data 00: Off

01: On

Acknowledgement

[j][ ][Set ID][ ][OK/NG][Data][x]

**43. Tile H Size (Command: d g)**

To set the Tile Horizontal Size.

\*Set Tile H Position to 0x32 (50) before setting Tile H Size.

\*Only available when Tile Natural Mode is off.

Transmission

[d][g][ ][Set ID][ ][Data][Cr]

Data 00 to 32: 0 to 50

Acknowledgement

[g][ ][Set ID][ ][OK/NG][Data][x]

**46. FAN Control (Command: d o)**

To set Fan control on/off.

Transmission

[d][o][ ][Set ID][ ][Data][Cr]

Data 00: Auto

01: On

02: Manual

Acknowledgement

[o][ ][Set ID][ ][OK/NG][Data][x]

**47. FAN Fault Check (Command: d w)**

To set Fan control on/off.

Transmission

[d][w][ ][Set ID][ ][Data][Cr]

Data FF: Data should be always ff in hexadecimal.

Acknowledgement

[w][ ][Set ID][ ][OK/NG][Data][x]

**48. Temperature Value (Command: d n)**

To read the inside temperature of the display.

Transmission

[d][n][ ][Set ID][ ][Data][Cr]

Data FF: Data should be always ff in hexadecimal.

Acknowledgement

[n][ ][Set ID][ ][OK/NG][Data][x]

**49. Key (Command: m c)**

To send IR remote control code.

Transmission

[m][c][ ][Set ID][ ][Data][Cr]

Data IR\_KEY\_CODE

Acknowledgement

[c][ ][Set ID][ ][OK][Data][x]

When display is in the standby mode, display will turn on by Power button of remote control only.

**50. OSD Select (Command: k l)**

To select OSD(On Screen Display) on/off

Transmission

[k][l][ ][Set ID][ ][Data][Cr]

Data 00: OSD Off

01: OSD On

Acknowledgement

[l][ ][Set ID][ ][OK/NG][Data][x]

**51. Elapsed time return (Command: d l)**

To read the panel used time.

Transmission

[d][l][ ][Set ID][ ][Data][Cr]

Data FF: Data should be always ff in hexadecimal.

Acknowledgement

[l][ ][Set ID][ ][OK/NG][Data][x]

\* Returned data means used hours in hexadecimal.

**52. Serial No.Check (Command: f y)**

To read the serial numbers.

Transmission

[f][y][ ][Set ID][ ][Data][Cr]

Data FF: Data should be always ff in hexadecimal.

Acknowledgement

[y][ ][Set ID][ ][OK/NG][Data][x]



**53. S/W Version (Command: f z)**

To read the software version.

Transmission

[f][z][ ][Set ID][ ][Data][Cr]

Data FF: Data should be always ff in hexadecimal.

Acknowledgement

[z][ ][Set ID][ ][OK/NG][Data][x]

**56. White Balance Blue Gain (Command: j o)**

To adjust white balance blue gain.

Transmission

[j][o][ ][Set ID][ ][Data][Cr]

Data 00 to FE: Blue gain 0 to 254

Acknowledgement

[o][ ][Set ID][ ][OK/NG][Data][x]

**54. White Balance Red Gain (Command: j m)**

To adjust white balance red gain.

Transmission

[j][m][ ][Set ID][ ][Data][Cr]

Data 00 to FE: Red gain 0 to 254

Acknowledgement

[m][ ][Set ID][ ][OK/NG][Data][x]

**55. White Balance Green Gain (Command: j n)**

To adjust white balance green gain.

Transmission

[j][n][ ][Set ID][ ][Data][Cr]

Data 00 to FE: Green gain 0 to 254

Acknowledgement

[n][ ][Set ID][ ][OK/NG][Data][x]



Make sure to read the Safety Precautions before using the product. Keep the Owner's Manual(CD) in an accessible place for future reference. The model and serial number of the SET is located on the back and one side of the SET. Record it below should you ever need service.

MODEL \_\_\_\_\_

SERIAL \_\_\_\_\_

ENERGY STAR is a set of power-saving guidelines issued by the U.S. Environmental Protection Agency(EPA).



As an ENERGY STAR Partner LGE U. S. A.,Inc. has determined that this product meets the ENERGY STAR guidelines for energy efficiency.

Temporary noise is normal when powering ON or OFF this device.