



OWNER'S MANUAL

WASHING MACHINE

Before beginning installation, read these instructions carefully. This will simplify installation and ensure that the washer is installed correctly and safely. Leave these instructions near the washer after installation for future reference.

WD14135D6



P/No.: MFL67473455

www.lg.com

Contents

Contents.....2

Product Features.....3

Important safety instructions

Important safety instructions4
Basic safety precautions5
Save these instructions.....6

Specifications7

Installation

Removing packing8
Removing transit bolts8
Installation place requirements9
Connecting water supply hose11
Installation of drain hose13
Leveling.....14

How to use washer

Operating washing machine16
Care before washing.....17
Washing program table.....18
Extra options19
Operating data20
Control panel.....21
Additional program.....22
- Time Delay.....22
- Crease Care22
- Favorite22
- Pre Wash22
Options.....23
- Medic Rinse23
- Wash.....23
- Temp.23
- Rinse23
- Spin23
- Rinse+Spin23
Other functions.....23
- Spin Only23
Child Lock24
Beep On/Off.....24
Tub Clean25
Door Lock & Detecting25

Thank you for buying a LG Fully Automatic Washing Machine.

Please read your owner's manual carefully, it provides instruction on safe installation, use and maintenance. Retain it for future reference.

Record the model and serial number of your washing machine.

Model No.

Serial No.

Date of Purchase

Adding detergent

Adding detergent and fabric softener ..26

Maintenance

The water inlet filter.....28
The drain pump filter29
Dispenser drawer30
The washing drum31
Cleaning your washer31
Cold conditions31

Troubleshooting guide

Diagnosing problems32
Error messages.....34
Using SMARTDIAGNOSIS™35

Product Features



- **Inverter Direct Drive system**

The advanced Brushless DC motor directly drives the drum without belt and pulley.



- **6 Motion**

Washer is able to perform various drum actions or a combination of different actions depending on the wash program selected. Combined with a controlled spin speed and the ability of the drum to rotate both left and right, the wash performance of the machine is greatly improved, giving you perfect results every time.



- **Protection against creases**

With the alternating rotation of the drum, creasing is minimized.



- **Built-in heater**

Internal heater automatically heats the water to the best temperature on selected cycles.



- **More economical with Intelligent Wash system**

Intelligent Wash System detects the size of load and water temperature, and then determines the optimum water level and washing time to minimize energy and water consumption.



- **Child Lock**

The Child Lock prevents children from pressing any button to change the settings during operation.



- **Low noise speed control system**

By sensing the amount of load and balance, it evenly distributes load to minimize the spinning noise level.

Important safety instructions

READ ALL INSTRUCTIONS AND EXPLANATION OF THE INSTALLATION BEFORE USE

⚠ WARNING

For your safety, the information in this manual must be followed to minimize the risk of fire or explosion, electric shock, or to prevent property damage, injury to persons, or death.

Your Safety and the safety of others are very important.

We have provided many important safety messages in this manual and on your appliance. Always read and obey all safety messages.

⚠ This is the safety alert symbol.

This symbol alerts you to potential hazards that can kill or hurt you and others. All safety messages will follow the safety alert symbol and either the word DANGER, WARNING or CAUTION.

These words mean:

⚠ DANGER

You will be killed or seriously injured if you don't immediately follow instructions.

⚠ WARNING

You can be killed or seriously injured if you don't follow instructions.

⚠ CAUTION

You may be slightly injured or cause damage to the product, if you do not follow instructions.

All safety messages will tell you what the potential hazard is, tell you how to reduce the chance of injury, and tell you what can happen if the instructions are not followed.

Important safety instructions

■ Basic safety precautions

WARNING

To reduce the risk of fire, electric shock, or injury to persons when using the washer, follow basic precautions, including the following:

- **Before installation, check for exterior damages. If it has, do not install.**
- **Do not install or store the washer where it will be exposed to the weather.**
- **Do not tamper with controls.**
- **Do not repair or replace any part of the washer or attempt any servicing unless specifically recommended in the user-maintenance instructions or published user-repair instructions that you understand and have the skills to carry out.**
- **Keep the area underneath and around your appliances free of combustible materials such as lint, paper, rags, chemicals, etc.**
- **The appliance is not intended for use by young children or infirm persons without supervision. Do not allow children to play on, with, or inside this or any other appliance.**
- **Keep small animals away from the appliance.**
- **Do not leave the washer door open.**
An open door could entice children to hang on the door or crawl inside the washer.
- **Never reach into washer while it is moving. Wait until the drum has completely stopped.**
- **The laundry process can reduce the flame retardant of fabrics. To avoid such a result, carefully follow the garment manufacturer's wash and care instructions.**
- **Do not wash or dry articles that have been cleaned in, washed in, soaked in, or spotted with combustible or explosive substances (such as wax, oil, paint, gasoline, degreasers, dry-cleaning solvents, kerosene, etc.) which may ignite or explode.** Oil may remain in the tub after a whole cycle resulting in fire during drying.
So, do not load oiled clothes.
- **Do not slam the washer door closed or try to force the door open when locked.** This could result in damage to the washer.
- **When the machine runs high temperature, the front door may be very hot. Don't touch it.**
- **To minimize the possibility of electric shock, unplug this appliance from the power supply or disconnect the washer at the household distribution panel by removing the fuse or switching off the circuit breaker before attempting any maintenance or cleaning.**
- **When unplugging power cord, do not pull out by grasping the cord.**
Otherwise, the power cord may be damaged.
- **Never attempt to operate this appliance if it is damaged, malfunctioning, partially disassembled, or has missing or broken parts, including a damaged cord or plug.**

Important safety instructions

■ Basic safety precautions

WARNING

To reduce the risk of fire, electric shock, or injury to persons when using the washer, follow basic precautions, including the following:

- **Before discarding an old machine unplug it. Render the plug useless. Cut off the cable directly behind the appliance to prevent misuse.**
- **When a product was under water, Please call service center.** There is a risk of electric shock and fire.
- **Connect the appliance to the water mains using new hose-sets. Old hose-sets should not be reused.**
- **To reduce the risk of personal injury, adhere to all industry recommended safety procedures including the use of long sleeved gloves and safety glasses.** Failure to follow all of the safety warnings in this manual could result in property, personal injury or death.
- **Do not push down the door excessively, when washer door open.** This could topple over the washer.

■ Save these instructions

GROUNDING INSTRUCTIONS

This appliance must be grounded. In the event of malfunction or breakdown, grounding will reduce the risk of electric shock by providing a path of least resistance for electric current. This appliance is equipped with a cord having an equipment-grounding conductor and grounding plug. The plug must be plugged into an appropriate outlet that is properly installed and grounded in accordance with all local codes and ordinance.

- Do not use an adapter this will defeat the grounding plug.
- If you don't have the proper outlet, consult an electrician.

WARNING

Improper connection of the equipment-grounding conductor can result in electric shock. Check with a qualified electrician or serviceman if you are in doubt as to whether the appliance is properly grounded. Do not modify the plug provided with the appliance - if it does not fit the outlet, have a proper outlet installed by a qualified electrician.

Specifications

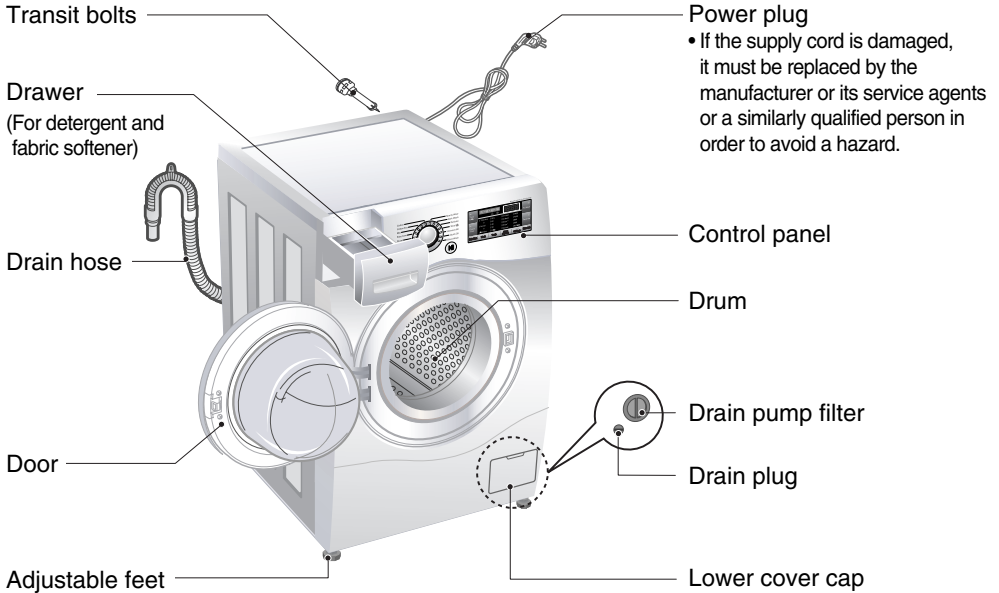

- Name : Front loading washing machine
- Power supply : 220 - 240 ~, 50 Hz
- Size : 600 mm(W) × 640 mm(D) × 850 mm(H)
- Weight : 68 kg
- Max.Watt : 2100 W
- Wash capacity : 8.5 kg
- Permissible water pressure : 100 - 800 kPa (1.0 - 8.0 kgf / cm²)

- The external hot water supply MUST NOT exceed 65°C
- Permissible cold water temperature : 4 - 25°C
- No further backflow protection required for connection to the water supply.
- The appearance and specifications may be varied without notice to Improve the units quality.
- Specifications subject to change by manufacturer.

■ Accessories

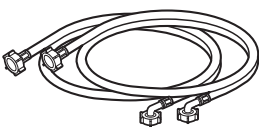

Inlet hose: Hot/Cold(2EA)



Spanner

Installation

■ Removing packing

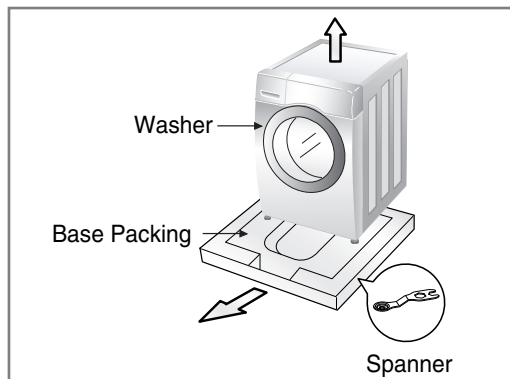

1. Remove the cardboard box and styrofoam packing.
2. Lift the washing machine and remove the base packing. This will require 2 or more people or a lifting device.
3. Remove the tape securing the power supply cord and drain hose.
4. Remove the inlet hoses from the drum.

● NOTE

- Keep the spanner provided for future use.

⚠ WARNING

- Packaging material (e.g. Films, Styrofoam) can be dangerous for children. There is a risk of suffocation ! **Keep all packaging well away from children.**

■ Removing transit bolts

To prevent internal damage during transport, the 4 special bolts are locked. Before operating the washer, remove the bolts along with the rubber bungs. If they are not removed, it may cause heavy vibration, noise and malfunction.

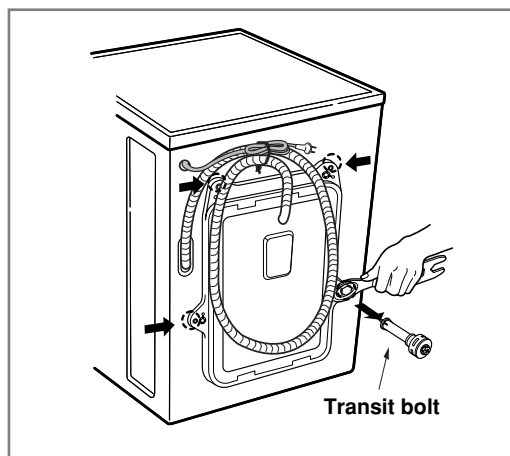

1. Unscrew the 4 bolts with the spanner supplied.
2. Take out the 4 bolts along with the rubber bungs by slightly twisting the bung.

● NOTE

- Keep the transit bolts for future use.
3. Close the holes with the caps supplied.

Installation

■ Installation place requirements

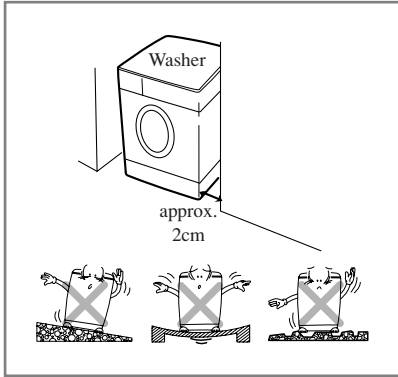

► Location

- **Level floor :**
Allowable slope under entire washer is 1°.
- **Power outlet :**
Must be within 1.5 meters of either side of location of washer. Do not overload the outlet with more than one appliance.
- **Additional Clearance :**
For Wall, 10cm:rear / 2cm : right & left side
Do not place, store or use laundry products on top of washer at any time.
They can damage the finish or controls.

► Positioning

- Install the washer on a flat hard floor.
- Make sure that air circulation around the washer is not impeded by carpets, rugs, etc.
- Never try to correct any unevenness in the floor with pieces of wood, cardboard or similar materials under the washer. Do not build the machine into a closed cupboard.
- If it is impossible to avoid positioning the washer next to a gas cooker or coal burning stove, an insulating (85x60cm) covered with aluminum foil on the side facing the cooker or stove, must be inserted between the two appliance.
- The washer must not be installed in rooms where the temperature can drop below 0°C.
- Please ensure that when the washer is installed, it is easily accessible for a Service Technician in the event of a breakdown.
- With the washer installed, adjust all four feet using the transit bolt spanner provided ensuring the appliance is stable, and a clearance of approximately 20mm is left between the top of the washer and the underside of any work-top.
- This equipment is not designed for maritime use or for use in a mobile installations such as caravans, aircraft etc.
- It is also not intended for commercial or outdoor applications, or washing of items such as foot ware, mats etc.

Installation

► Electrical connection

- Do not use an extension cord or double adapter.
- If the supply cord is damaged, it must be replaced by the manufacturer or its service agents or similarly qualified person in order to avoid a hazard.
- Always unplug the machine and turn off the water supply after use.
- Connect the machine to an earthed socket in accordance with current wiring regulations.
- The appliance must be positioned so that the plug is easily accessible.
- Repairs to the washing machine must only be carried out by qualified personnel. Repairs carried out by inexperienced persons may cause serious injury or malfunction. Contact your local service center
- Do not install your washing machine in rooms where temperature below freezing may occur. Frozen hoses may burst under pressure. The reliability of the electronic control unit may be impaired at temperatures below freezing point.
- If the appliance is delivered in the winter months and temperatures are below freezing : Place the washing machine at room temperature for a few hours before putting it into operation.

⚠ CAUTION

CAUTION concerning the Power cord

- Most appliances recommend they be placed upon a dedicated circuit; that is, a single outlet circuit which powers only that appliance and has no additional outlets or branch circuits. **Check the specification page of this owner's manual to be certain.**
- **Do not overload wall outlets.** Overloaded wall outlets, loose or damaged wall outlets, extension cords, frayed power cords, or damaged or cracked wire insulation are dangerous. Any of these conditions could result in an electric shock or fire.
- **Periodically examine the cord of your appliance**, and if its appearance indicates damage or deterioration, unplug it, discontinue use of the appliance, and have the cord replaced with an exact replacement part by an authorized servicer.
- **Protect the power cord from physical or mechanical abuse**, such as being twisted, kinked, pinched, closed in a door, or walked upon. Pay particular attention to plugs, wall outlets, and the point where the cord exits the appliance.
If the appliance is supplied from a cord extension set or an electrical portable outlet device, the cord extension set on electrical portable outlet device must be positioned so that it is not subject to splashing or ingress of moisture.

⚠ CAUTION

- The appliance is not intended for use by young children or infirm persons without supervision.
- Young children should be supervised to ensure that they do not play with appliance.

Installation

■ Connecting water supply hose

- Water supply pressure must be between 100 kPa and 800 kPa (1.0 - 8.0 kgf / cm²).
- Do not strip or crossthread when connecting inlet hose to the valve.
- If the water supply pressure is more than 800 kPa, a water pressure reduction device should be installed.
- Periodically check the condition of the hose and replace the hose if necessary.

► Step1 : Check rubber seal inlet hose

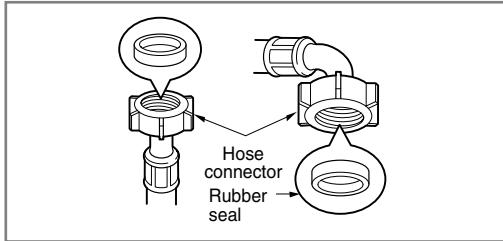

- Two rubber seals are supplied with the water inlet hoses. They are used for preventing water leaks. Make sure the connections to taps are sufficiently tight.
- Do not use pliers, multi grips or leverage tools to tighten. Hand tighten only. Use a cloth if necessary.

► Step2 : Connect hose to water tap

Type-A : Connecting Screw-type hose to tap with thread

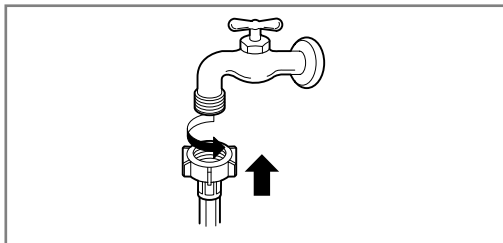

- Screw the hose connector onto water supply tap.

Type-B : Connecting Screw-type hose to tap without thread

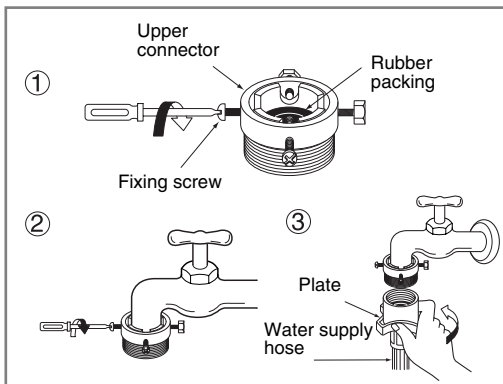

1. Unscrew the adapter ring plate and the 4 adapter retaining screws.
2. Push the adapter onto the end of the tap so that the rubber seal forms a watertight connection. Tighten the adapter ring plate and the 4 screws.
3. Push the water supply hose vertically upwards so that the rubber packing within the hose can adhere completely to the tap and then tighten it by screwing it to the right.

Installation

Type-C : Connecting one touch type hose to tap without thread

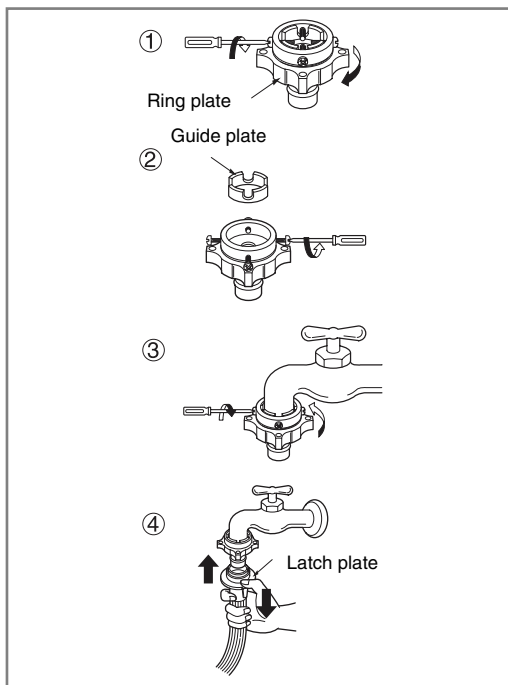

1. Unscrew the adapter ring plate and the 4 adapter retaining screws.
2. Remove the guide plate if the tap is too large to fit the adapter.
3. Push the adapter onto the end of the tap so that the rubber seal forms a watertight connection. Tighten the adapter ring plate and the 4 screws.
4. Pull the connector latch plate down, push the inlet hose onto the adapter, and release the connector latch plate. Make sure the adapter locks into place.

NOTE

- After connecting inlet hose to water tap, turn on the water tap to flush out foreign substances (dirt, sand or sawdust) in the water lines. Let water drain into a bucket, and check the water temperature.

► Step3: Connect hose to washer

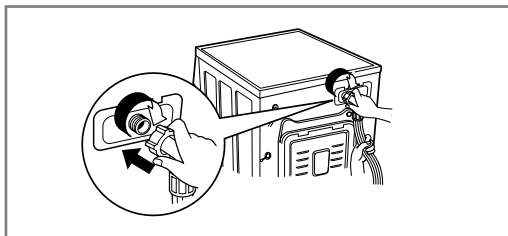

- Make sure that there are no kinks in the hose and that they are not crushed.
- **When your washer has two inlet valves**
 - The Inlet hose which has red connector is for the hot water tap.
 - When using warm or hot washes, Energy can be saved by connecting the hot water hose to a hot water supply.

NOTE

- After completing connection, if water leaks from the hose, repeat the same steps.

Please use the horizontal tap

Horizontal tap



Extension tap



Square tap



Installation

■ Installation of drain hose

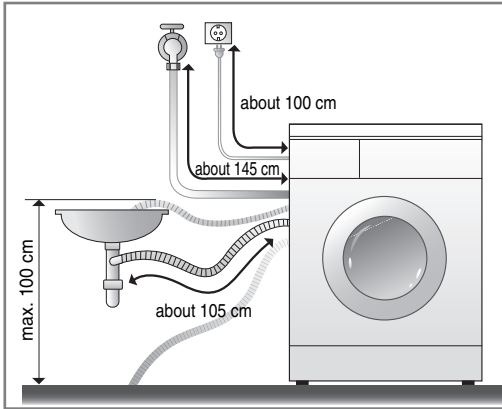

- The drain hose should not be placed higher than 100 cm above the floor. Water in the washer does not drain or drains slowly if above this height.
- Securing the drain hose correctly will protect the floor from damage due to water leakage.
- If the drain hose is too long, do not force it back into the washer. This will cause abnormal noise, possible water leakage and malfunction.

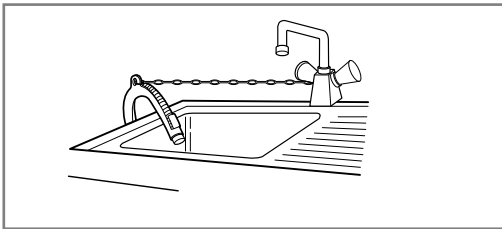

- When installing the drain hose to a sink, secure it tightly with string.
- Securing the drain hose correctly will protect the floor from damage due to water leakage.

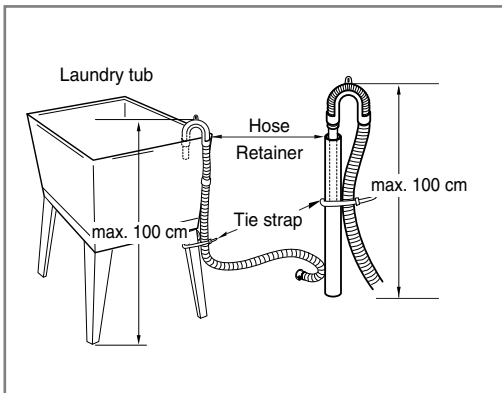

Installation

■ Leveling

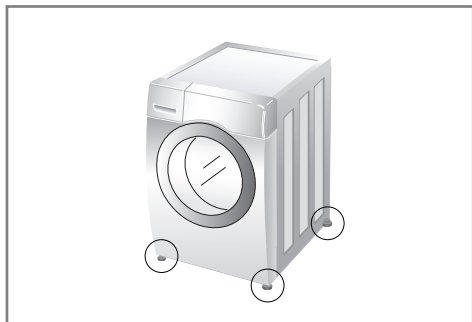

1. Leveling the washing machine properly prevents excessive noise and vibration. Install the appliance on a solid and level floor surface, preferably in a corner of the room.

NOTE

- Timber or suspended type flooring may contribute to excessive vibration and unbalance.

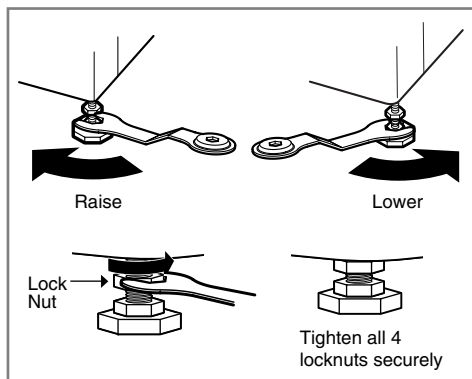

2. If the floor is uneven, turn the adjustable feet as required (do not insert pieces of wood etc. under the feet). Make sure that all four feet are stable and resting on the floor and then check that the appliance is perfectly level (use a spirit level).
- Once the washer is level, tighten the lock nuts up towards the base of the washer. All lock nuts must be tightened.

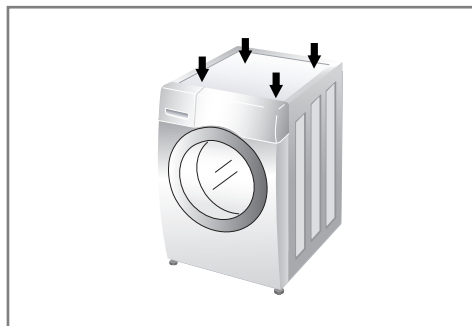

- Diagonal Check
When pushing down the edges of the washing machine top plate diagonally, the machine should not move up and down at all (Please, check both directions). If machine rocks when pushing the machine top plate diagonally, adjust the feet again.

NOTE

Do not install the machine on a raised platform.

Installation

► Concrete floors

- The installation surface must be clean, dry and level.
- Install washer on a flat hard floor.

► Tile floors (Slippery floors)

- Position each foot on the Tread Mate and level the machine to suit. (Cut Tread Mate into 70x70 mm sections and stick the pieces on to the dry tile where machine is to be placed.)
- Tread Mate is a self adhesive material used on ladders & steps that prevents slipping.

► Wooden floors (Suspended floors)

- Wooden floors are particularly susceptible to vibration.
- To help reduce vibration we recommend you place rubber cups under each foot under washer at least 15mm thick, secured to at least 2 floor beams with screws.
- If possible install the washer in one of the corners of the room, where the floor is more stable.
- Fit the rubber cups to reduce vibration.
- You can obtain the rubber cups (p/no.4620ER4002B) from the LG spares dept.
- If vibration persists with rubbers fitted. The flooring structure or rigidity may be inadequate for proper operation.

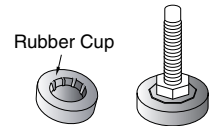

NOTE

- Proper placement and levelling of the washer will ensure long, regular and reliable operation.
- The washer must be 100% horizontal and stand firmly in position.
- It must not “Seesaw” across corners under load.
- The installation surface must be clean, free from floor wax and other lubricant coatings.
- Do not let the feet of the washer get wet. If feet of the washer get wet, slipping may occur.

How to use washer

■ Operating washing machine

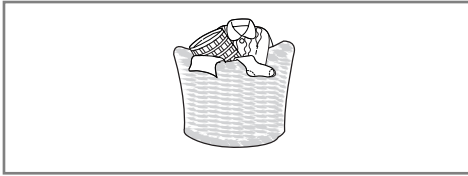

1. Sort Laundry.
(Refer to 17 page)

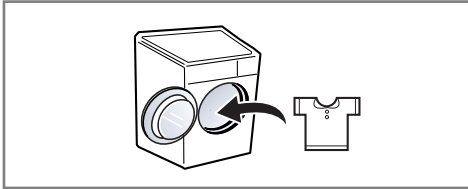

2. Open the door and load laundry.



3. Press the Power button.

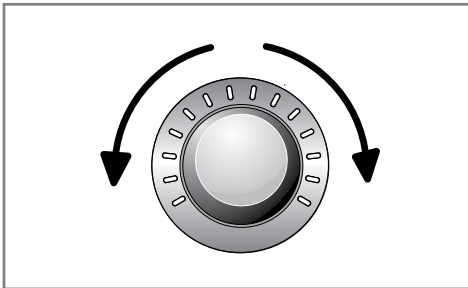

4. Select a Program.
(Refer to 18~20 page)

Select options at this time
(Refer to 22~25 page)

- Additional Program
- Temperature
- Spin Speed
- Other functions

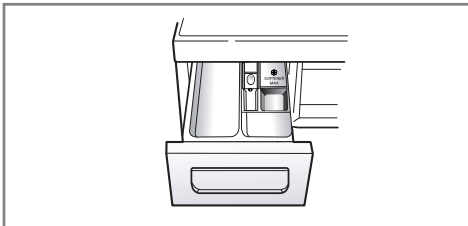

5. Add detergent.
(Refer to 26~27 page)



6. Press the Start/Pause button.

How to use washer

■ Care before washing

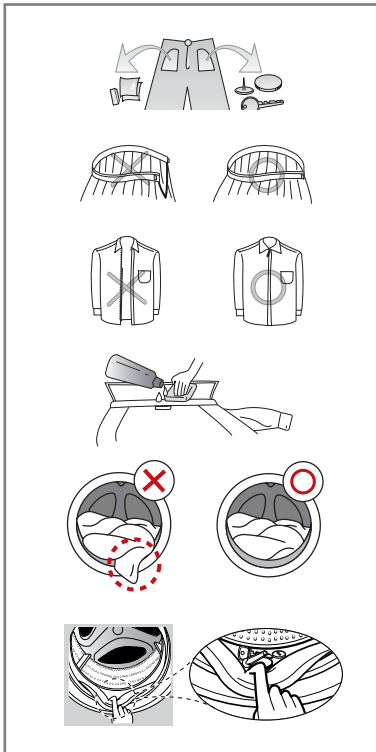
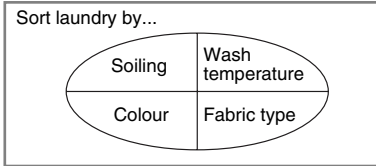
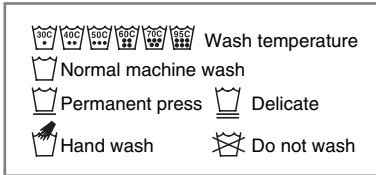

1. Care Labels

Look for a care label on your clothes.

This will tell you about the fabric content of your garment and how it should be washed.

2. Sorting

To get the best results, sort clothes into loads that can be washed with the same wash cycle.

Water temperature and spin speed and different fabrics need to be washed in different ways.

Always sort dark colors from pale colors and whites.

Wash separately as dye and lint transfer can occur causing discolouration of white etc. If possible, do not wash heavily soiled items with lightly soiled one.

- Soil (Heavy, Normal, Light)
Separate clothes according to amount of soil.
- Color (White, Lights, Darks)
Separate white fabrics from colored fabrics.
- Lint (Lint producers, Collectors)
Wash lint producers and lint collectors separately.

3. Caring before loading

Combine large and small items in a load. Load large items first. Large items should not be more than half the total wash load. Do not wash single items.

This may cause an out-of-balance load. Add one or two similar items.

- Check all pockets to make sure that they are empty. Items such as nails, hair clip, matches, pens, coins and keys can damage both your washer and your clothes.
- Close zippers, hooks and strings to make sure that these items don't snag on other clothes.
- Pre treat dirt and stains by brushing a little detergent dissolved in water onto stains like collars and cuffs to help lift dirt.
- Check the folds of the flexible gasket (gray) and remove any small articles.
- Check inside of the drum and remove any item from a previous wash.
- Remove any clothing or items from the flexible gasket to prevent clothing and gasket damage.

❗ NOTE

- Before the first wash, select a cycle (Cotton 60°C, add a half load of detergent) allow the unit to wash without clothing. This will remove residues and water from the drum that may have been left during manufacturing.

How to use washer

■ Washing program table

- Recommended courses according to the laundry type.

Program	Description	Fabric type	Proper Temp.	Maximum Load
Cotton	Provides better performance by combining various drum motions.	Color fast garments (shirts, nightdresses, pajamas, etc) and normally soiled cotton load (underwear).	40°C (Cold to 95°C)	Rating
Cotton Eco	Provide optimized washing performance with less energy consumption.		60°C (Cold to 60°C)	
Easy Care	This cycle is suitable for casual shirts that do not need ironing after washing.	Polyamide, Acrylic, Polyester.	40°C (Cold to 60°C)	Less then 4.5 kg
Mix	Enables various fabrics to be washed simultaneously.	Various kind of fabrics except special garments. (Silk/delicate, sports wear, dark clothes, wool, Duvet/Curtains).	40°C (Cold to 40°C)	
Baby care	Remove solid and protein stain and provide better rinse performance	Lightly soiled baby wear	60°C (95°C)	
Silent Wash	Provides less noise and vibration and saves money by using overnight electricity.	Color fast garments (shirts, nightdresses, pajamas, etc)and lightly soiled white cotton (underwear).	40°C (Cold to 60°C)	Less then 5.0 kg
Skin Care	Remove efficiently detergent residue in clothes	Fabrics which will be in direct contact with the skin, e.g. underwear, nappies, towelling, bed linen, pillow and mattress covers		Rating
Duvet	This cycle is for large items such as bed cover, pillows, sofa covers, etc.	Cotton bedding except special garments (delicates, wool, silk, etc.) with filling: duvets, pillows, blankets, sofa covers with light filling.	40°C (Cold to 40°C)	1 single size
Sports Wear	This cycle is suitable for sports wear such as jogging clothes and running wear.	Coolmax, Gore-tex, fleece and Sympatex.		
Dark Wash	If it's possible for clothes to decolorate, please use this cycle. The cycle prevent decolorization. (Please use detergent for colored fabrics.)	Dark garments made from cotton or mixed fabrics.	30°C (Cold to 40°C)	Less then 3.0 kg
Delicate	This cycle is for delicate clothes such as underwear, blouse, etc.	Delicate, easily damaged laundry.		
Wool 	Enable to wash wool fabrics. (Please use detergent for machinewashable woolens).	Machine washable woolens with pure new wool only.	40°C (Cold to 40°C)	
Quick 30	This cycle provides fast washing time for small loads and lightly soiled clothes.	Colored laundry which is lightly soiled fast.	30°C (Cold to 40°C)	
Intensive 60	Within 60mins provide better washing performance and energy efficiency.	Cotton and mix fabrics. (Special PROGRAM within 60 mins for normally soiled laundry).	60°C (Cold to 60°C)	Less then 4.5 kg

How to use washer

- **Water Temperature:** Select water temperature to suit wash cycles. Always follow garment manufacture's care label or instructions when washing.
- Set program at "Cotton Eco, 40°C, Intensive, Normal Rinse, 1400RPM" is for normally soiled load and test in accordance or in conformity with AS/NZS 2040.1.
- The test results depend on water pressure, water hardness, water inlet temperature, room temperature, type and amount of load, degree of soiling utilized detergent, fluctuations in the main electricity supply and chosen additional options.
- For best washing results, we recommend to mix dry detergent with warm water.



The wool wash cycle of this machine has been approved by Woolmark for the washing of machine washable Woolmark products provided that the products are washed according to the instructions on the garment label and those issued by the manufacturer of this washing machine M1008.

NOTE

- Neutral detergent is recommended.
- The wool cycle features gentle tumbling and low-speed spin for garment care.

Extra options

Program	Time Delay	Crease Care	Favorite	Pre Wash	Medic Rinse	Rinse + Spin	Time Save	Intensive
Cotton	●	●	●	●	●	●	●	●
Cotton Eco	●	●	●	●	●	●	●	●
Easy Care	●	●	●	●	●	●	●	●
Mix	●	●	●	●	●	●	●	●
Baby Care	●	●	●	● ^{**}	● ^{**}	●		●
Silent Wash	●	●	●			●	●	●
Skin Care	●	●	●	●	●	●	●	●
Duvet	●	●	●			●	●	●
Sports Wear	●	●	●			●	●	●
Dark Wash	●	●	●			●	●	●
Delicate	●	●	●			●	●	●
Wool 	●	●	●			●		●
Quick 30	●	●	●			●		●
Intensive 60	●	●	●			●		● [*]

* : This option is automatically included in the cycle and can not be deleted.

** : This option is automatically included in the cycle and can be deleted.

How to use washer

■ Operating data

Program	Max RPM
Cotton	1400
Cotton Eco	1400
Easy Care	1000
Mix	1400
Baby Care	1000
Silent Wash	1000
Skin Care	1400
Duvet	1000
Sports Wear	800
Dark Wash	1400
Delicate	800
Wool 	800
Quick 30	1400
Intensive 60	1400

How to use washer

■ Control panel

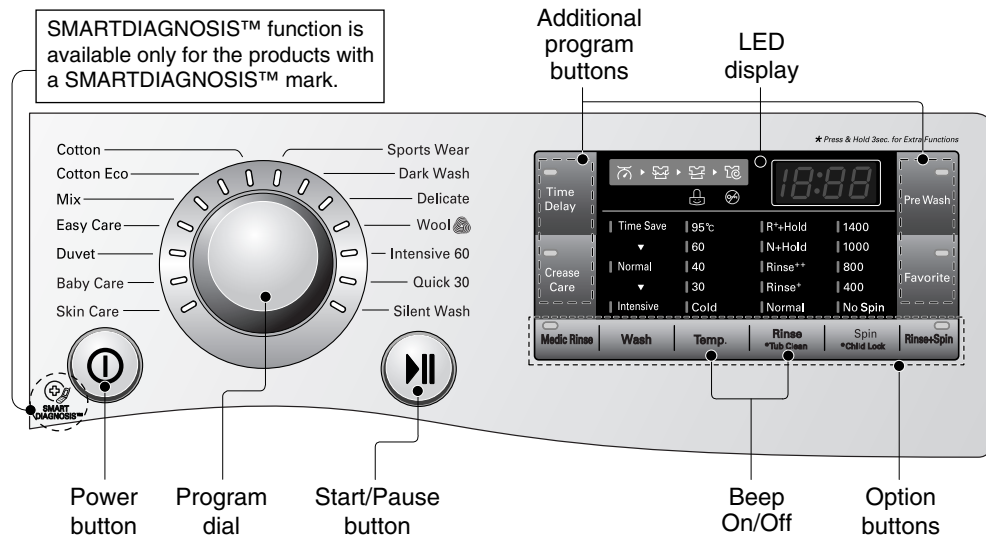

Power

- Press the Power button to turn power on and off.
- To cancel the Time Delay function, the power button should be pressed.

Program dial

- Turn the Dial to select the cycle appropriate to the laundry type.
- Lamp will light up to indicate selected program.

Start/Pause

- This **Start/Pause** button is used to start wash cycle or pause the wash cycle.
- If temporary stop of wash cycle is needed, press the **Start/Pause** button.
- When in Pause, the power is turned off automatically after 4 minutes.

Additional program

- Use these buttons to select the desired cycle options for the selected cycle.
- Some options may be limited to certain cycles.

LED display

- The display shows the settings, estimated time remaining, options, and status messages for your washer. The display will remain on through the cycle.

Options

- This allows you to select an additional option and will light when selected.

How to use washer

■ Additional program

Time Delay

You can set a time delay so that the washing machine will start automatically and finish after a specified time interval.

NOTE

- The delay time is the time to the end of the programme, not the start. The actual running time may vary due to water temperature, wash load and other factors.

1. Press the Power button.
2. Select a cycle.
3. Touch the Time Delay button and set time required.
4. Press the Start/Pause button.

Crease Care

If you want to prevent creasing, select Crease Care option.

1. Press the Power button.
2. Select a cycle.
3. Touch the **Crease Care** button.
4. Press the Start/Pause button.

Favorite

Favorite program allows you to store a customized wash cycle for future use.

1. Press the Power button.
2. Select a cycle.
3. Select the course.
(Washing method, number of rinses, spin speed, water temperature etc.)
4. Touch and hold Favorite program button for 3 seconds.

The Favorite program is now stored for future use.

To reuse the program, select Favorite program and press the Start/Pause.

Pre Wash

If the laundry is heavily soiled, "Pre Wash" course is effective.

1. Press the Power button.
2. Select a cycle.
3. Touch the Pre Wash button and add the detergents.
4. Press the Start/Pause button.

How to use washer

■ Options

Medic Rinse

For best results or for cleaner rinsing. This allows the final rinse to be heated to 40 degrees.

1. Press the Power button.
2. Select a cycle.
3. Touch the Medic Rinse button and set time required.
4. Press the Start/Pause button.

Wash

- **Time Save** : This option can be used to reduce the time of a wash program. It is best used on lightly soiled loads.
- **Intensive** : If a normal load is heavily soiled, "Intensive" option is effective.

Temp.

- By touching the Temp. button the water temperature can be selected.
 - Cold
 - 30°C, 40°C, 60°C, 95°C
- Water temperature selection is limited in certain programs.

Rinse

- **R++Hold** : Add rinse once then after rinsing process, the course is paused until start button is pressed again.
- **N+Hold** : The course is paused until start button is pressed again when rinse is finished.
- **Rinse++** : Add rinse twice.
- **Rinse+** : Add rinse once.

Spin

- Spin Speed level can be selected by touching 'Spin' button repeatedly.

Rinse+Spin

This can be helpful in preventing fresh stains from setting in fabrics. This is a separate cycle.

1. Press the Power button.
 2. Select a cycle.
 3. Touch the Option button (Rinse+Spin light up).
 4. Press the Start/Pause.
- The cycle chosen determines the amount of Rinses and their duration as well as the spin during for this function.

■ Other functions

Spin Only

1. Press the Power button.
2. Touch the Spin button to select RPM.
3. Press the Start/Pause.

NOTE

When you select "No Spin", it will still rotate for a short time with low speed to drain quickly.

How to use washer

■ Child Lock

Select this function to lock the buttons on the control assembly to prevent tampering. "Child Lock" can be set only during the washing cycle.

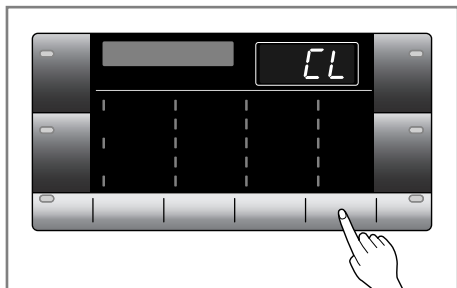

Locking the control panel

1. Touch and hold the Child Lock button for 3 seconds.
2. A beeper will sound, and 'CL' will appear on the LED display. When the child lock is set, all buttons are locked except the Power button.

● NOTE

- Turning off the power will not reset the child lock function. You must deactivate child lock before you can access any other functions.

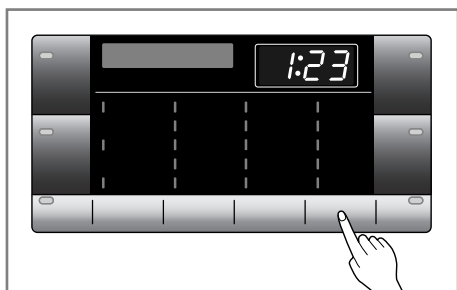

Unlocking the control panel

1. Touch and hold the Child Lock button for 3 seconds.
2. A beeper will sound and the remaining time for the current programme will reappear on the LED display.

■ Beep On / Off

The Beep on/off function can be set only during the washing cycle.

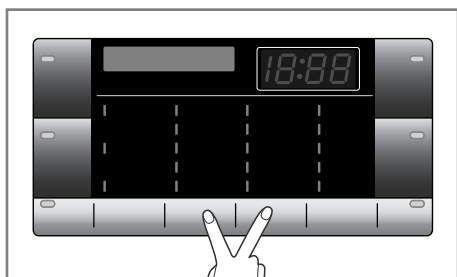

1. Press the Power button.
2. Press the Start/Pause button.
3. Touch and hold the Temp. and Rinse button simultaneously for three seconds to set Beep on/off function.

Once the Beep on/off function is set, the setting is memorized even after the power is turned off.

● NOTE

- If you want to turn the Beeper on, simply repeat this process.

How to use washer

■ Tub Clean

Tub Clean is a special cycle to help clean the inside of the washing machine. A higher water level and higher spin speed is used in this cycle. Perform this cycle regularly.

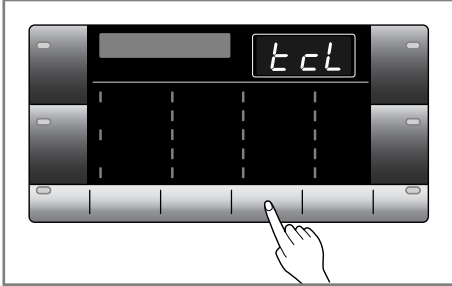

1. Remove any clothing or items from the washer and close the door.
2. Open the dispenser drawer and add Anti limescale (e.g. Calgon) to the main wash compartment.
3. Close the dispenser drawer slowly.
4. Power On and then touch and hold **Tub Clean** button for 3 seconds. then "TCL" will be displayed on the LED display.
5. Press the Start/Pause button to start.
6. After the cycle is complete, leave the door open to allow the washer door opening, flexible gasket and door glass to dry.

● NOTE

- Do not put clothes or soap detergents into the washer during this cycle. It can cause it to malfunction or become damaged.
- Do not add any detergent to the detergent compartments.
- Excessive suds may generate and leak from the washer.

▲ CAUTION

- If there is a child, be careful not to leave the door open for too long.

■ Door Lock & Detecting

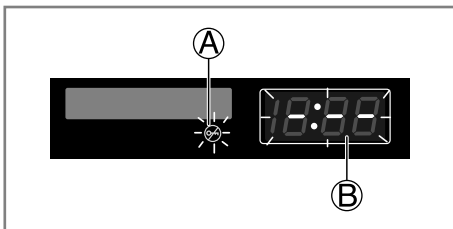

- (A) "**Door Lock**" - For safety reasons, the door will lock while machine is in use and the "Door Lock" icon will light up. You can safely open the door after the "Door Lock" icon turns off. This can take up to 3 minutes.
- (B) While "**Detecting**" is shown on the display the washing machine rotates slowly and detects how much laundry is loaded in the drum. It will take a short time.

Adding detergent

■ Adding detergent and fabric softener

▶ The dispenser drawer

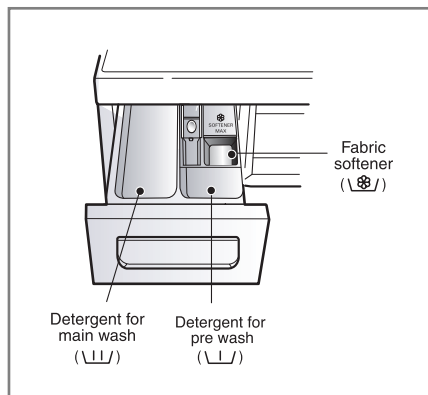

- Main wash only → \\|/
- Pre Wash + Main Wash → \\|/ • \\|/

⚠ WARNING

- **Keep all washing detergents away from children** as there is danger of poisoning.
- Too much detergent, bleach or softener may cause an overflow.
- Be sure to use the appropriate amount of detergent.

📌 NOTE

Powdered detergent is recommended as it will not dispense prematurely during delay washes or remain under the drawer.

▶ Adding fabric softener

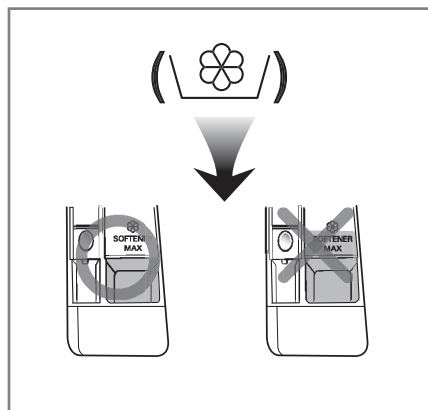

- Do not exceed the maximum fill line. Overfilling can cause early dispensing of the fabric softener which could stain clothes. Close the dispenser drawer slowly.
- Do not leave the fabric softener in the detergent drawer for more than 2 days. (Fabric softener could be harden)
- Softener will automatically be added during the last rinse cycle.
- Do not open the drawer when water is supplied.
- Solvents(benzene, etc) should not be used.

📌 NOTE

- Do not pour fabric softener directly on the clothes.

Adding detergent

► Detergent dosage

- Detergent should be used according to the instruction of the detergent manufacture.
- If too much detergent is used, too many suds can occur and this will decrease the washing result or cause heavy load to the motor.
- It is recommended that you use powdered detergent for best results.
- If you wish to use liquid detergent follow guidelines provided by the detergent manufacturer.
- You can pour liquid detergent directly into the main detergent drawer if you are starting the cycle immediately.
- Please do not use liquid detergent if you are using 'Time Delay ' as the liquid may harden, or if you have selected 'Pre Wash'.
- If too many suds occur, please reduce the detergent amount.
- Detergent usage may need to be adjusted for water temperature, water hardness, size and soil level of the load. For best results, avoid oversudsing.

⚠ WARNING

- **Do not let the detergent harden.**
Doing so may lead to blockages, poor rinse performance or bad odor.

📌 NOTE

- Full load : according to manufacturer's recommendation.
 - Part load : 3/4 of the normal amount.
 - Minimum load : 1/2 of full load.
- Detergent is flushed from the dispenser at the beginning of the cycle.

► Adding water softener



- A water softener, such as Anti-limescale (e.g. Calgon) can be used to cut down on the use of detergent in extremely hard water areas. Dispense according to the amount specified on the packaging. First add detergent and then the water softener.
- Use the quantity of detergent as for soft water.

► Using tablet

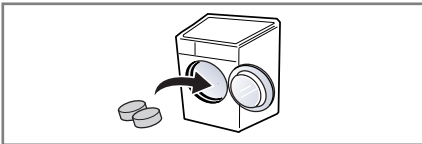

1. Open the door and put tablets into the drum.

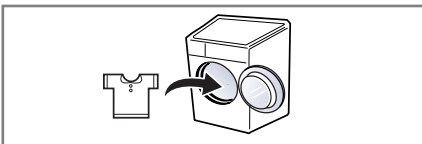

2. Load the laundry into the drum and close the door.

Maintenance

- Before cleaning the washer interior, unplug the electrical power cord to avoid electrical shock hazards.
- Turn off the stopcock if the machine is to be left for any length of time (e.g. holiday), especially if there is no floor drain(gully) in the immediate vicinity.

■ The water inlet filter

- " E " icon will be displayed on the control panel when water does not enter the detergent drawer.
- If water is very hard or contains traces of lime deposit, the water inlet filter may become clogged.
It is therefore a good idea to clean it from time to time.

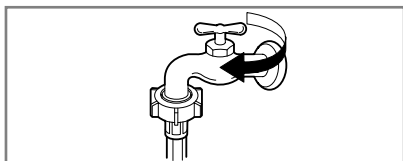

1. Turn off the water tap.

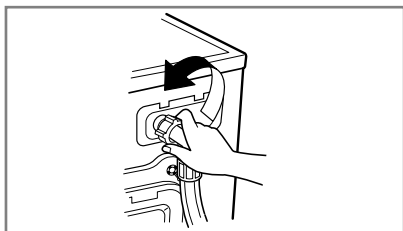

2. Unscrew the water inlet hose.

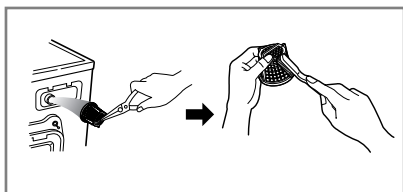

3. Clean the filter using a hard bristle brush.

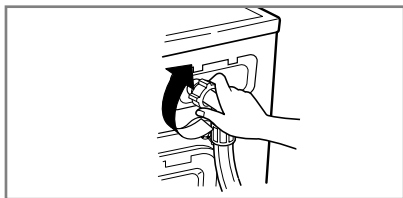

4. Refit and tighten up the inlet hose.

Maintenance

■ The drain pump filter

- The drain filter collects threads and small objects left in the laundry.
Check regularly that the filter is clean to ensure smooth running of your machine.

⚠ CAUTION

- First drain using the drain hose and then open the pump filter to remove any threads or objects. **Be careful when draining if the water is hot.**
- Allow the water to cool down before cleaning the drain pump, carrying out emergency emptying or opening the door in an emergency.

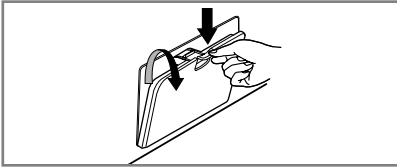

1. Open the lower cover cap.
Pull out the hose.

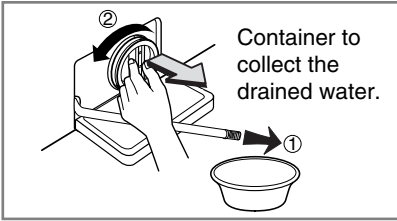

2. Unplug the drain plug first to remove any remaining water.
Open the filter cap by turning to the left.

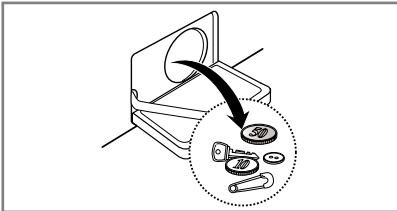

3. Remove any extraneous matter from the pump filter.

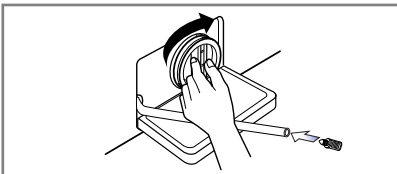

4. After cleaning, carefully refit the cap by slowly turning it clockwise and insert the drain plug.

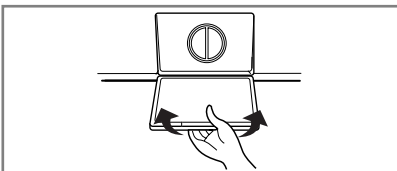

5. Close the lower cover cap.
If water leaks from the cover after refitting the filter cap. Repeat steps 1 and 2 and Refit the filter cap as it may be cross threaded.

Maintenance

■ Dispenser drawer

- After a while, detergents and fabric softeners leave a deposit in the drawer.
- It should be cleaned from time to time with a jet of running water.
- If necessary it can be removed completely from the machine by pressing the catch downwards and by pulling it out.
- To facilitate cleaning, the upper part of the fabric softener compartment can be removed.

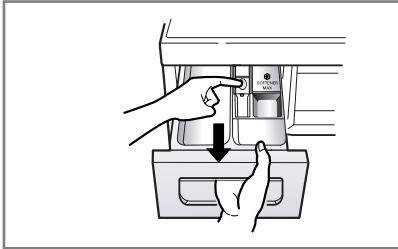

1. Pull out the dispenser drawer.

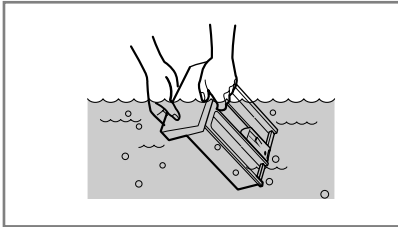

2. Clean the dispenser drawer under water.

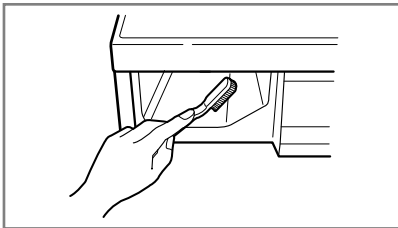

3. Clean inside the recess with an old toothbrush.

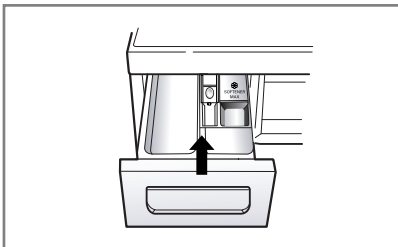

4. Insert the dispenser drawer.

Maintenance

■ The washing drum

- If you live in a hard water area, limescale may build up continuously in places where it cannot be seen and thus not easily removed. Over time the build up of scale clogs appliances, and if it is not kept in check these may have to be replaced.
- Although the washing drum is made of Stainless steel, specks of rust can be caused by small metal articles (paper clips, safety pins) which have been left in the drum.
- The washing drum should be cleaned from time to time.
- If you use descaling agents, dyes or bleaches, make sure they are suitable for washing machine use.
- Descaler may contain chemicals that may damage part of your washing machine.
- Remove any spots with a stainless steel cleaning agent.
- Never use steel wool.

■ Cleaning your washer

► Exterior

- Proper care of your washer can extend its life.
- The outside of the machine can be cleaned with warm water and a neutral non abrasive household detergent.
- Immediately wipe off any spills. Wipe with damp cloth.
- Try not to hit surface with sharp objects.
- Do not use methylated spirits, diluents or similar products.

► Interior

- Dry around the washer door opening, flexible gasket and door glass.
- Run washer through a complete cycle using hot water.
- Repeat process if necessary.

ⓘ NOTE

- To remove hard water deposits, use only cleaners labelled washer safe.

■ Cold conditions

If the washer is stored in an area where freezing may occur or moved in freezing temperatures, follow these instructions to prevent damage to the washer:

- Turn off water supply tap.
- Disconnect hoses from water supply and drain water from hoses.
- Plug electrical cord into a properly grounded electrical outlet.
- Add 1gallon (3.8L) of nontoxic recreational vehicle(RV) antifreeze into an empty wash drum. Close the door.
- Set spin cycle and let washer spin for 1minute to drain out all water. Not all of the RV antifreeze will be expelled.
- Unplug electrical power cord, dry the drum interior, and close the door.
- Remove dispenser drawer, drain and dry excess water from the compartments.
- Store washer in an upright position.
- To remove antifreeze from washer after storage, run empty washer through a complete cycle using detergent. Do not add wash load.

Troubleshooting guide

- This washing machine is equipped with automatic safety functions which detect and diagnose faults at an early stage and react appropriately.
When the machine does not function properly or does not function at all, check the following points before you contact your service provider.

■ Diagnosing Problem











Symptom	Possible Cause	Solution
Rattling and clanking noise	<ul style="list-style-type: none"> • Foreign objects such as coins or safety pins maybe in drum or pump. 	<p>Stop washer, check drum and drain filter.</p> <p>If noise continues after washer is restarted, call your authorised service centre.</p>
Thumping sound	<ul style="list-style-type: none"> • Heavy wash loads may produce a thumping sound. This is usually normal. 	<p>If sound continues, washer is probably out of balance. Stop and redistribute wash load.</p>
Vibrating noise	<ul style="list-style-type: none"> • Have all the transit bolts and packing been removed? • Are all the feet resting firmly on the ground? 	<p>If not removed during installation, refer to Installation guide for removing transit bolts.</p> <p>Wash load may be unevenly distributed in drum. Stop washer and rearrange wash load.</p>
Water leaks.	<ul style="list-style-type: none"> • Fill hoses or drain hose are loose at tap or washer. • House drain pipes are clogged. 	<p>Check and tighten hose connections.</p> <p>Unclog drain pipe. Contact plumber if necessary.</p>
Oversudsing		<p>Too much detergent or unsuitable detergent may cause excessive foaming which may result in water leaks.</p>
Water does not enter washer or it enters slowly	<ul style="list-style-type: none"> • Water supply is not adequate in area. • Water supply tap is not completely open. • Water inlet hose(s) are kinked. • The filter of the inlet hose(s) clogged. 	<p>Check another tap in the house.</p> <p>Fully open tap.</p> <p>Straighten hose.</p> <p>Check the filter of the inlet hose.</p>
Water in the washer does not drain or drains slowly.	<ul style="list-style-type: none"> • Drain hose is kinked or clogged. • The drain filter is clogged. 	<p>Clean and straighten the drain hose.</p> <p>Clean the drain filter.</p>

Troubleshooting guide

Symptom	Possible Cause	Solution
Washer does not start	<ul style="list-style-type: none"> • Electrical power cord may not be plugged in or connection may be loose. • House fuse blown, circuit breaker tripped, or a power outage has occurred. • Water supply tap is not turned on. 	<p>Make sure plug fits tightly in wall outlet.</p> <p>Reset circuit breaker or replace fuse. Do not increase fuse capacity. If problem is a circuit overload, have it corrected by a qualified electrician. Turn on water supply tap.</p>
Washer will not spin	<ul style="list-style-type: none"> • Check that the door is firmly shut. 	<p>Close the door and press the Start/Pause button. After pressing the Start/Pause button, it may take a few moments before the washer begins to spin. The door must be locked before spin can be achieved. Add 1 or 2 similar items to help balance the load. Rearrange load to allow proper spinning.</p>
Door does not open		<p>Once machine has started, the door cannot be opened for safety reasons. Check if the "Door Lock" icon is illuminated. You can safely open the door after the "Door Lock" icon turns off.</p>
Wash cycle time delayed		<p>The washing time may vary by the amount of laundry, water pressure, water temperature and other usage conditions. If an imbalance is detected or if the suds removing programme is on, the wash time shall be increased.</p>
Fabric softener overflow	Too much softener may cause an overflow.	Follow softener guidelines to ensure appropriate amount is used. Do not exceed the maximum fill line
Softeners dispensed too early		Close the dispenser drawer slowly. Do not open the drawer during the wash cycle.

Troubleshooting guide

■ Error Messages

Symptom	Possible Cause	Solution
	<ul style="list-style-type: none"> • Water supply is not adequate in area. • Water supply taps are not completely open. • Water inlet hose(s) are kinked. • The filter of the inlet hose(s) are clogged. 	<p>Check another tap in the house. Fully open tap. Straighten hose(s). Check the filter of the inlet hose.</p>
	<ul style="list-style-type: none"> • Drain hose is kinked or clogged. • The drain filter is clogged. 	<p>Clean and straighten the drain hose. Clean the drain filter.</p>
	<ul style="list-style-type: none"> • Load is too small. • Load is out of balance. • The appliance has an imbalance detection and correction system. If individual heavy articles are loaded (ex. bath mat, bath robe, etc.) this system may stop spinning or even interrupt the spin cycle altogether. • If the laundry is still too wet at the end of the cycle, add smaller articles of laundry to balance the load and repeat the spin cycle. 	<p>Add 1 or 2 similar items to help balance the load. Rearrange load to allow proper spinning.</p>
	 <ul style="list-style-type: none"> • Ensure door is not open. 	<p>Close the door completely. *If “dE” is not released, call for service.</p>
		<p>Unplug the power plug and call for service.</p>
	<ul style="list-style-type: none"> • Water overfills due to the faulty water valve. 	<p>Close the water tap. Unplug the power plug. Call for service.</p>
	<ul style="list-style-type: none"> • Water level sensor has malfunctioned. 	
	<ul style="list-style-type: none"> • Over load in motor. 	<p>Allow the washer to stand for 30 minutes to allow the motor to cool; then restart the cycle.</p>
	<ul style="list-style-type: none"> • The washer experienced a power failure. 	<p>Restart the cycle.</p>

Troubleshooting guide

NOTE

- SMARTDIAGNOSIS™ function is available only for the products with a SMARTDIAGNOSIS™ mark. In case of a mobile phone with static option, the SMARTDIAGNOSIS™ function might not operate.

■ Using SMARTDIAGNOSIS™

- Only use this feature when instructed to do so by the call center.

The transmission sounds similar to a fax machine, and so has no meaning except to the call center.

- SMARTDIAGNOSIS™ cannot be activated if the washer does not power up.

If this happens, then troubleshooting must be done without SMARTDIAGNOSIS™.

If you experience problems with your washer, call to Customer information center.

Follow the call center agent's instructions, and do the following steps when requested:

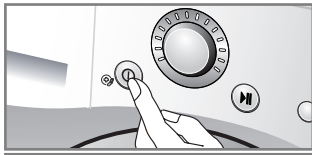

1. Press the Power button to turn on the washer. Do not press any other buttons or turn the cycle selector knob.

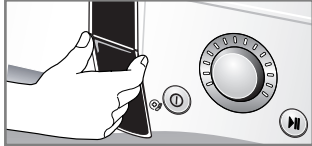

2. When instructed to do so by the call center, place the mouthpiece of your phone very close to the Power button.

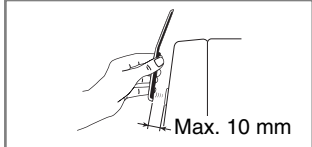

3. Touch and hold the "Temp." button for three seconds, while holding the phone mouthpiece to the icon or Power button.
 4. Keep the phone in place until the tone transmission has finished.
This takes about 6 seconds, and the display will count down the time.
 - For best results, do not move the phone while the tones are being transmitted.
 - If the call center agent is not able to get an accurate recording of the data, you may be asked to try again.
 - Pressing the Power button during the transmission will shut off the SMARTDIAGNOSIS™.
 5. Once the countdown is over and the tones have stopped, resume your conversation with the call center agent, who will then be able to assist you using the information transmitted for analysis at the call to Customer information center.
- Smart Diagnosis is a troubleshooting feature designed to assist, not replace, the traditional method of troubleshooting through service calls. The effectiveness of this feature depends upon various factors, including, but not limited to, the reception of the cellular phone being used for transmission, any external noise that may be present during the transmission, and the acoustics of the room where the machine is located.

Accordingly, LG does not guarantee that Smart Diagnosis would accurately troubleshoot any given issue.

