



LG

Life's Good

ENGLISH

OWNER'S MANUAL

LED TV (CINEMA 3D Smart TV)

LG LED TV applies LCD screen with LED backlights.
Please read this manual carefully before operating the your TV
and retain it for future reference.

27MT93V
27MT93S

TABLE OF CONTENTS

3 LICENSES

4 INSTALLATION PROCEDURE

5 ASSEMBLING AND PREPARING

- 5 Unpacking
- 7 - Separate purchase
- 9 Parts and buttons
- 10 Lifting and moving the TV
- 11 Setting up the TV
- 11 - Attaching the Stand
- 12 - Mounting on a table
- 13 - Tidying cables
- 14 - Detaching the Stand

15 WATCHING TV

- 15 Turning the TV on for the first time

17 MAKING CONNECTIONS

- 17 Connecting an antenna
- 18 Satellite connection
- 19 Connecting to a HD receiver, DVD, VCR player or Gaming device
- 19 - HDMI connection
- 20 - HDMI to DVI connection
- 21 - Component connection
- 22 - Composite connection
- 23 - Euro Scart connection
- 24 - Headphone connection
- 25 Connecting to a USB
- 26 Connecting to a CI Module
- 27 MHL connection
- 28 Connecting to a wired network
- 29 Connecting to a PC
- 30 - HDMI connection
- 31 - HDMI to DVI connection

32 REMOTE CONTROL

34 MAGIC REMOTE CONTROL FUNCTIONS

- 35 Registering Magic Remote Control
- 35 How to use Magic Remote Control
- 35 Precautions to Take when Using the Magic Remote Control

36 USING THE USER GUIDE

37 MAINTENANCE

- 37 Cleaning Your TV
- 37 Screen and frame
- 37 Cabinet and stand
- 37 Power cord
- 38 Preventing "Image burn" or "Burn-in" on your TV screen

39 IF THE QUALITY OF THE 3D IMAGE IS NOT ACCEPTABLE, CHECK THE FOLLOWING

40 VIEWING 3D IMAGING

42 TROUBLESHOOTING

- 42 General
- 42 Using 3D mode

43 SPECIFICATIONS

LICENSES

Supported licenses may differ by model. For more information of the licenses, visit www.lg.com.



Manufactured under license from Dolby Laboratories. "Dolby" and the double-D symbol are trademarks of Dolby Laboratories.



The terms HDMI and HDMI High-Definition Multimedia Interface, and the HDMI logo are trademarks or registered trademarks of HDMI Licensing LLC in the United States and other countries.



ABOUT DIVX VIDEO: DivX® is a digital video format created by DivX, LLC, a subsidiary of Rovi Corporation. This is an official DivX Certified® device that plays DivX video. Visit divx.com for more information and software tools to convert your files into DivX videos.

ABOUT DIVX VIDEO-ON-DEMAND: This DivX Certified® device must be registered in order to play purchased DivX Video-on-Demand (VOD) movies. To obtain your registration code, locate the DivX VOD section in your device setup menu. Go to vod.divx.com for more information on how to complete your registration.

DivX Certified® to play DivX® video up to HD 1080p, including premium content.

DivX®, DivX Certified® and associated logos are trademarks of Rovi Corporation or its subsidiaries and are used under license.

Covered by one or more of the following U.S. patents: 7,295,673; 7,460,668; 7,515,710; 7,519,274



Manufactured under license under U.S. Patent Nos: 5,956,674; 5,974,380; 6,487,535 & other U.S. and worldwide patents issued & pending. DTS, the Symbol, & DTS and the Symbol together are registered trademarks & DTS 2.0 Channel is a trademark of DTS, Inc. Product includes software.
© DTS, Inc. All Rights Reserved.

INSTALLATION PROCEDURE

- 1 Open the package and make sure all the accessories are included.
- 2 Attach the stand to the TV.
- 3 Connect an external device to the TV.



NOTE

- Image shown may differ from your TV.
- Your TV's OSD (On Screen Display) may differ slightly from that shown in this manual.
- The available menus and options may differ from the input source or product model that you are using.
- New features may be added to this TV in the future.

ASSEMBLING AND PREPARING

Unpacking

Check your product box for the following items. If there are any missing accessories, contact the local dealer where you purchased your product. The illustrations in this manual may differ from the actual product and accessories.



NOTE

- The accessories supplied with your product may vary depending on the model.
- Product specifications or contents in this manual may be changed without prior notice due to upgrade of product functions.



CAUTION

- Do not use any pirated items to ensure the safety and product life span.
- Any damages or injuries by using pirated items are not covered by the warranty.

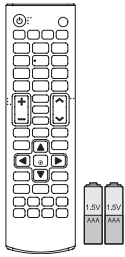

**Remote control
Batteries (AAA)**

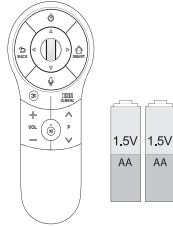

**Magic Remote Control.
Batteries (AA)**



CD (Owner's Manual)/Cards

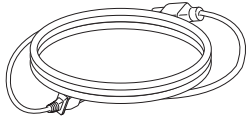

Power Cord

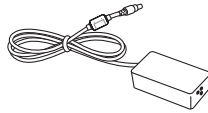

AC-DC Adapter

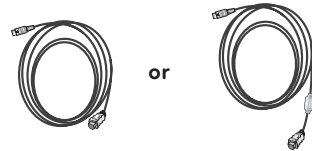

MHL passive cable

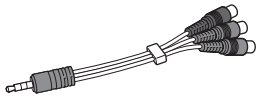

Component video cable

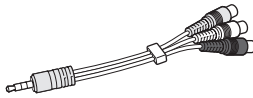

Composite audio/video cable



Stand Base



Screw Cover

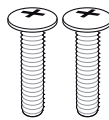

Screws 2 EA



Cable holder



3D Glasses(Normal type 2 EA)

- The number of 3D glasses may differ depending on the model or country.
- Image shown may differ from your TV.



**Isolator
(Depending on the country)**

Separate purchase



Dual play glasses

AG-F2**DP, AG-F3**DP

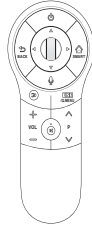

Magic Remote Control

AN-MR400



NOTE

- The illustrations in this manual may differ from the actual product and accessories.
- Separate purchase items can be changed or modified for quality improvement without any notification.
- Contact your dealer to buying these items.
- The model name or design may be changed depending on the upgrade of product functions, manufacturer's circumstances or policies.

**NOTE**

- Antenna Isolator Installation Guide

- Use this to install TV in a place where there is a voltage difference between TV Set and GND of antenna signal.
 - » If there is a voltage difference between TV Set and GND of antenna signal, the antenna contact might be heated and excessive heat might cause an accident.
- You can improve the safety when watching TV by efficiently removing power voltage from TV antenna. It is recommended to mount the isolator to the wall. If it cannot be mounted to the wall, mount it on the TV. Avoid disconnecting the antenna Isolator after installation.
- Before starting, be sure that the TV antenna is connected.

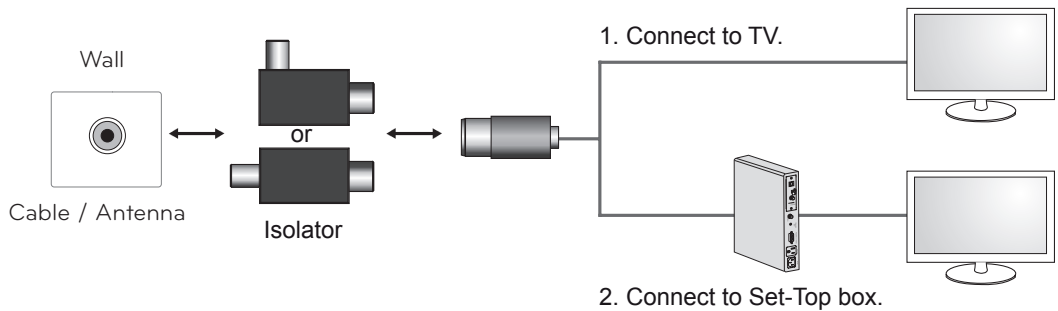

Connect one end of the isolator to cable/antenna jack and the other to TV set or set-top box.

"Equipment connected to the protective earthing of the building installation through the mains connection or through other equipment with a connection to protective earthing - and to a cable distribution system using coaxial cable, may in some circumstances create a fire hazard. Connection to a cable distribution system has therefore to be provided through a device providing electrical isolation below a certain frequency range (galvanic isolator, see EN 60728-11)"

When applying the RF Isolator, a slight loss of signal sensitivity can occur.

Parts and buttons

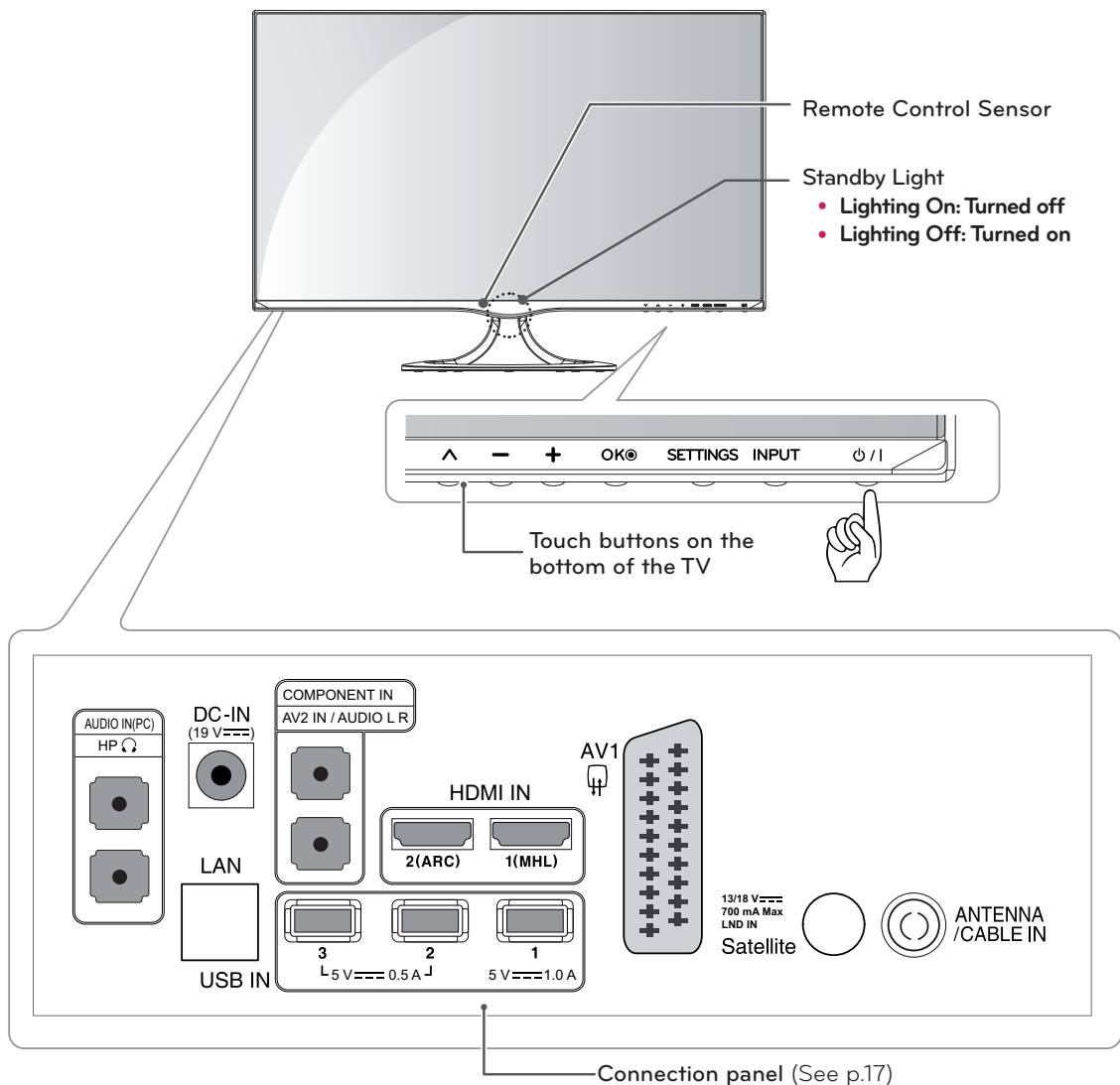

Touch button	Description
∨ ^	Scrolls through the saved programmes.
- +	Adjusts the volume level.
OK	Selects the highlighted menu option or confirms an input.
SETTINGS	Accesses the main menus, or saves your input and exits the menus.
INPUT	Changes the input source.
⏻ / I	Turns the power on or off.

NOTE

All of the buttons are touch sensitive and can be operated through simple touch with your finger.

Lifting and moving the TV

When moving or lifting the TV, read the following to prevent the TV from being scratched or damaged and for safe transportation regardless of its type and size.



CAUTION

Avoid touching the screen at all times, as this may result in damage to the screen or some of the pixels used to create images.

- It is recommended to move the TV in the box or packing material that the TV originally came in.
- Before moving or lifting the TV, disconnect the power cord and all cables.
- Hold the top and bottom of the TV frame firmly. Make sure not to hold the transparent part, speaker, or speaker grill area.

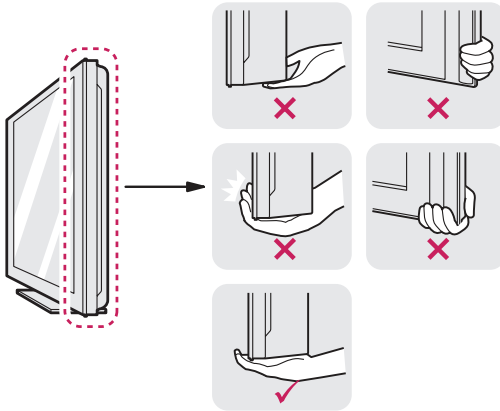

- When holding the TV, the screen should face away from you to prevent the screen from scratches.



- When transporting the TV, do not expose the TV to jolts or excessive vibration.
- When transporting the TV, keep the TV upright, never turn the TV on its side, or tilt towards the left or right.

Setting up the TV

Attaching the Stand

- 1 Place the TV with the screen side down on a flat and cushioned surface.

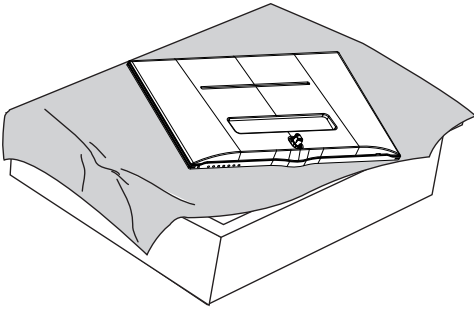

- 2 Check the orientation (front and rear) of the stand base and mount the stand base to the stand hinge as shown in the figure.

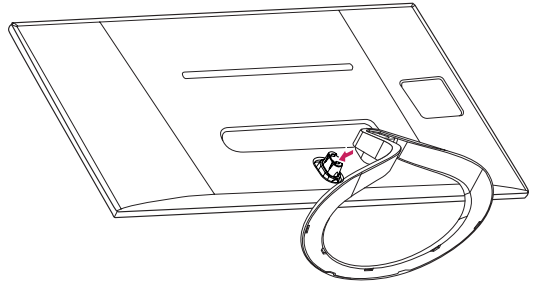

- 3 Fix two screws into the back of the stand base and close the screw cover.

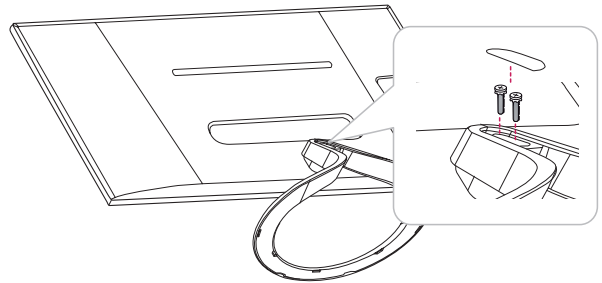

CAUTION

- Lay a foam mat or soft protective cloth on the surface to protect the screen from damage.
- When attaching the stand to the TV, place the screen facing down on a cushioned table or flat surface to protect the screen from scratches.



CAUTION

Tighten the screws firmly to prevent the TV from tilting forward. Do not over tighten.

Mounting on a table

- 1 Lift and tilt the TV into its upright position on a table.

Leave a 10 cm (4 inches) (minimum) space from the wall for proper ventilation.

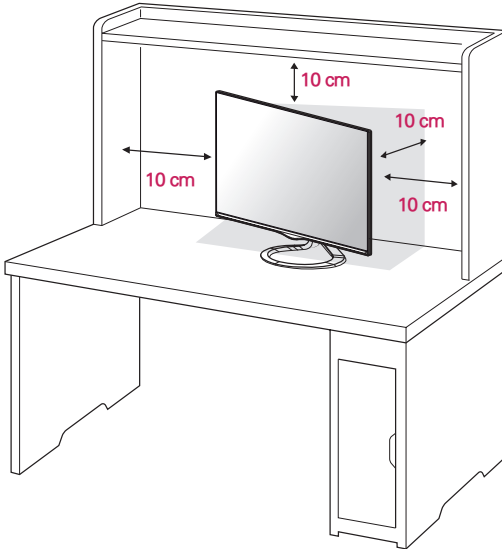

- 2 Connect the **AC-DC Adapter** and **Power Cord** to a wall outlet.

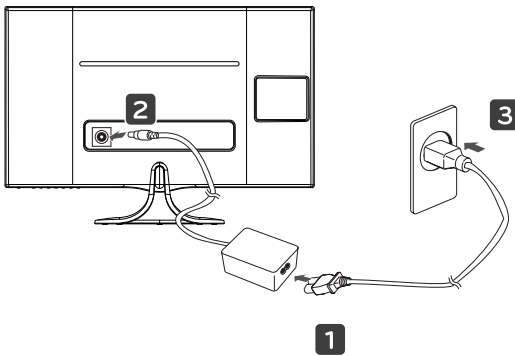

CAUTION

Do not place the TV near or on sources of heat, as this may result in fire or other damage.

! WARNING

When you adjust the angle, do not hold the bottom of the TV frame as shown on the following illustration, as may injure your fingers.

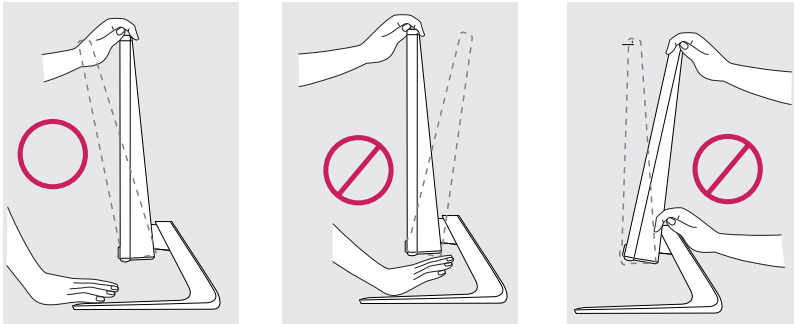

! CAUTION

Disconnect the power cord first, and then move or install the TV. Otherwise electric shock may occur.

! NOTE

Tilt from +20 to -5 degrees up or down to adjust the angle of the TV to suit your view.

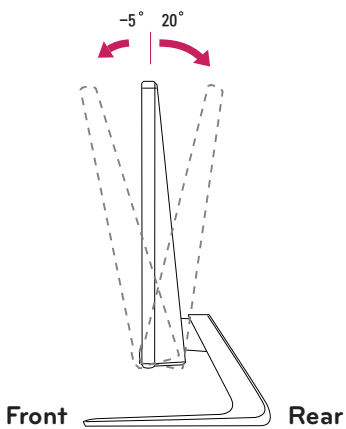

Tidying cables

- 1 Attach the cable holder to the edge of stand body securely.
- 2 Gather and bind the cables with the supplied cable holder.

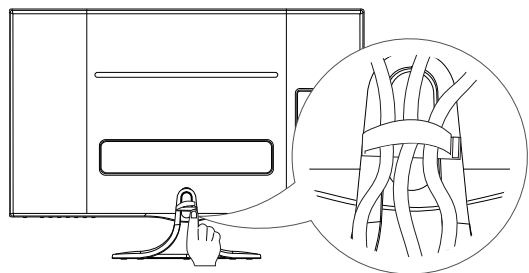

! CAUTION

After attachment, if the cable holder is pulled with excessive force, it may fall off.

Using the Kensington security system

The Kensington security system connector is located at the back of the TV. For more information of installation and using, refer to the manual supplied with the Kensington security system or visit <http://www.kensington.com>.

Connect the Kensington security system cable between the TV and a table.

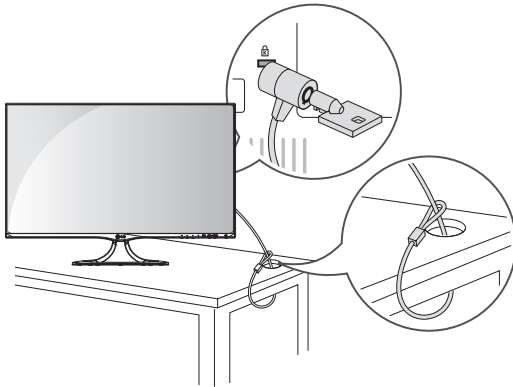

NOTE

The Kensington security system is optional. You can obtain additional accessories from most electronics stores.

Detaching the Stand

- 1 Place the TV with the screen side down on a flat and cushioned surface.

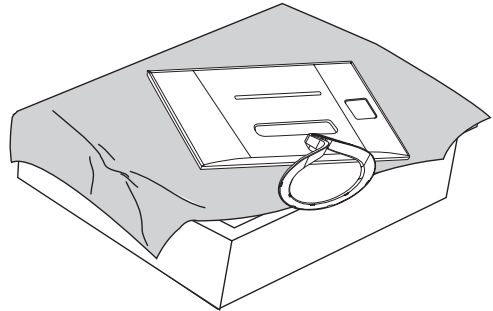

CAUTION

- Lay a foam mat or soft protective cloth on the surface to protect the screen from damage.
- When detaching the stand to the TV, place the screen facing down on a cushioned table or flat surface to protect the screen from scratches.

- 2 Open the screw cover on the back of the stand base and use a screwdriver to remove the two screws. Detach the stand base from the stand hinge as shown in the figure.

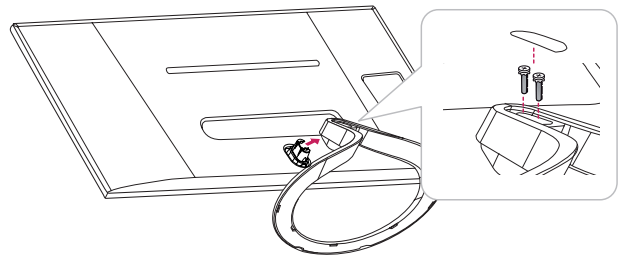

WATCHING TV

Turning the TV on for the first time

When you access the TV for the first time, the initial setting screen appears. Select a language and customize the basic settings.

- 1 Connect the power cord to a power outlet.
- 2 Press  on the TV or power button on the remote control to turn the TV on.
The Standby Light is turned off.
- 3 The initial setting screen appears if you access the TV for the first time.



NOTE

If you do not operate the TV within 40 seconds when the setting menu screen appears, the setting menus will disappear.

- 4 Follow the on-screen instructions to customize your TV according to your preferences.



NOTE

- For those countries without confirmed DTV broadcasting standards, some DTV features might not work, depending on the DTV broadcasting environment.
- When France is selected for Country, the initial password is not '0', '0', '0', '0' but '1', '2', '3', '4'.
- To display images in the best quality for your home environment, select **Home Use mode**.
- **Store Demo** mode is suitable for the retail environment.
- If you select **Store Demo mode**, the previously customized settings will switch to the default settings of **Store Demo mode** in 5 minutes.

- 5 When the basic settings are complete, press **OK**.



NOTE

If you do not complete the initial setting, it will appear whenever you access the TV.

- 6 To turn the TV off, press  on the TV.
The Standby Light is turned on.



CAUTION

Disconnect the power cord from the power outlet when you do not use the TV for a long period of time.



NOTE

You can also access Factory Reset by accessing **OPTION** in the main menus.

MAKING CONNECTIONS

Connect various external devices to the TV and switch input modes to select an external device. For more information about an external device's connection, refer to the manual supplied with each device. Available external devices are: HD receivers, DVD players, VCRs, audio systems, USB storage devices, PC, camcorders or cameras, gaming devices, and other external devices.

! NOTE

- If you record a TV program on a DVD recorder or VCR, make sure to connect the TV signal input cable to the TV through a DVD recorder or VCR. For more information about recording, refer to the manual supplied with the connected device.
- The external device connection may differ from the model.
- Connect external devices to the TV regardless of the order of the TV port.

Connecting an antenna

Connect an antenna, cable or cable box to watch TV referring to the following. The illustrations may differ from the actual accessories and an RF cable is optional.

Connect the TV to a wall antenna socket with an RF cable (75 Ω).

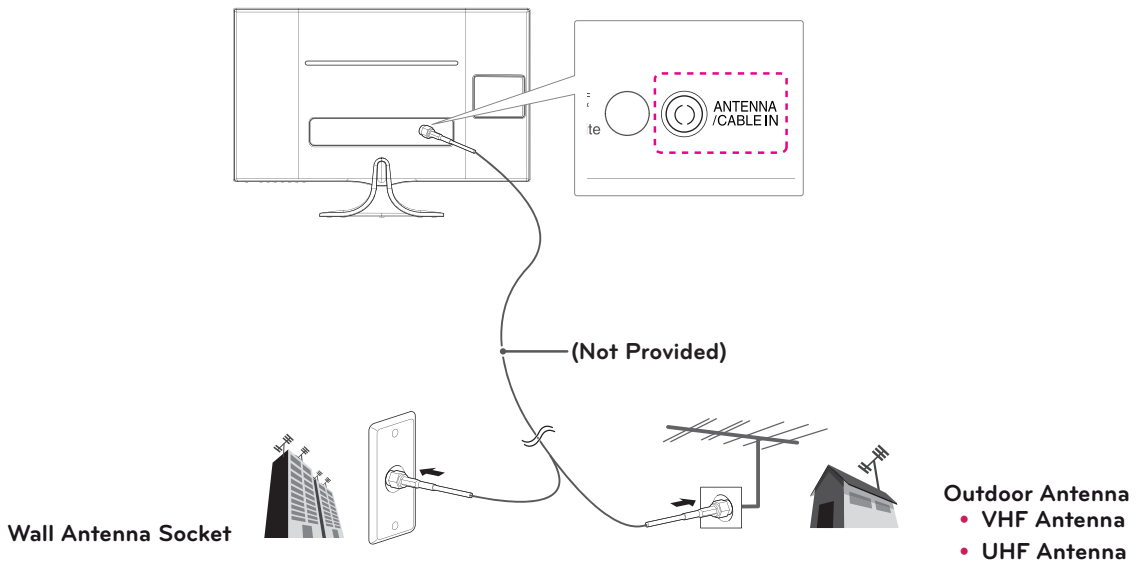

! NOTE

- Use a signal splitter to use more than 2 TVs.
- If the image quality is poor, install a signal amplifier properly to improve the image quality.
- If the image quality is poor with an antenna connected, aim the antenna to the proper direction.
- Visit <http://AntennaWeb.org> for more information about the antenna and cable connection.

! CAUTION

- Make sure not to bend the copper wire of the RF cable.

Copper wire

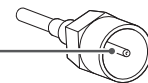

- Complete all connections instructions between devices, and then connect the power cord to the power outlet to prevent damages to your TV.

Satellite connection

Connect the TV to a satellite dish to a satellite socket with a satellite RF cable (75 Ω).

ENGLISH

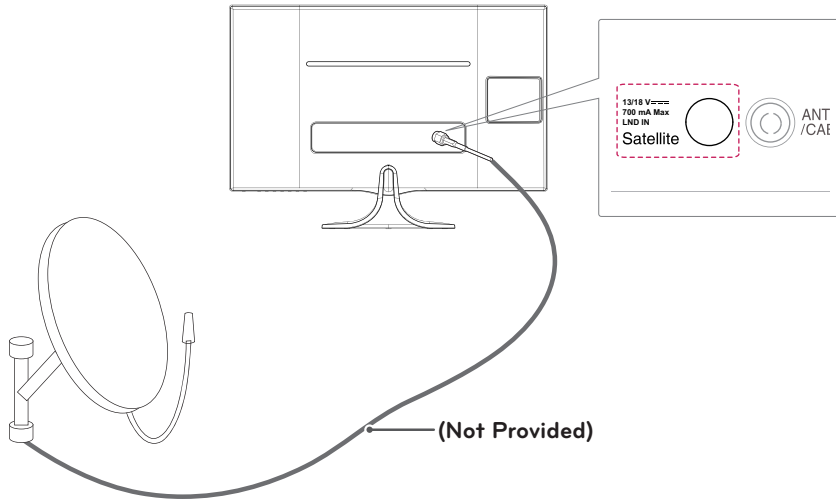

Connecting to a HD receiver, DVD, VCR player or Gaming device

Connect a HD receiver, DVD, VCR player or Gaming device to the TV and select an appropriate input mode.

HDMI connection

HDMI is the best way to connect a device.

Transmits the digital video and audio signals from an external device to the TV. Connect the external device and the TV with the HDMI cable as shown on the following illustration.

NOTE

- Use a High Speed HDMI™ Cable.
- High Speed HDMI™ Cables are tested to carry an HD signal up to 1080p and higher.
- Supported DTV Audio: MPEG, Dolby Digital.
- Supported HDMI Audio format: DTS, Dolby Digital, PCM (Up to 192 KHz, 32k/44.1k/48k/88k/96k/176k/ 192k.)

- Choose any HDMI input port to connect.
- It does not matter which port you use.

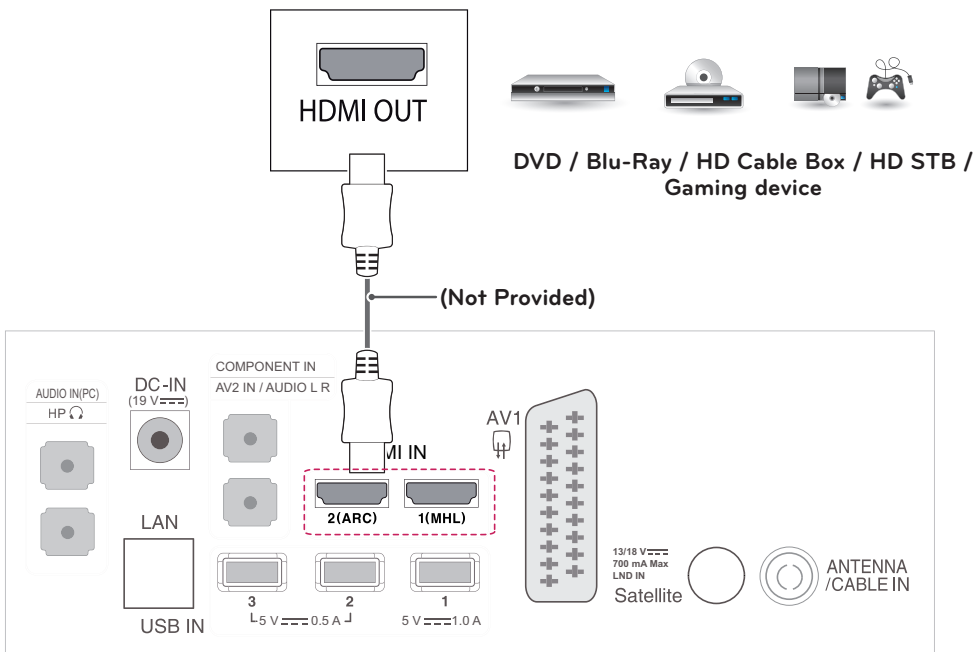

HDMI to DVI connection

Transmits the digital video signal from an external device to the TV. Connect the external device and the TV with the HDMI to DVI cable as shown in the following illustration. To transmit an audio signal, connect an optional audio cable.

NOTE

If you do not use an optional external speaker, connect the external device to the TV with the optional audio cable.

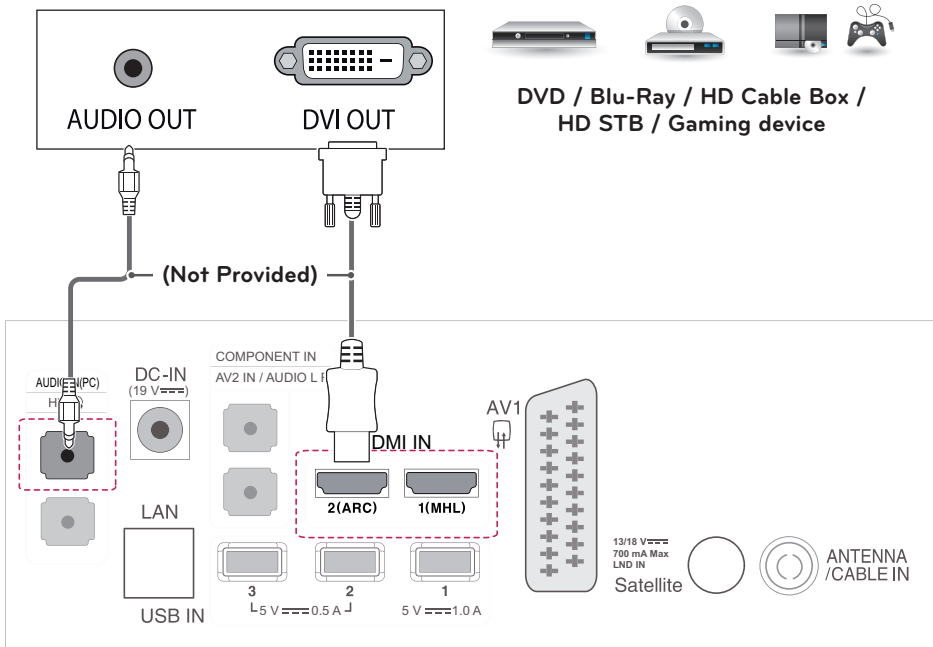

Component connection

Transmits the analog video and audio signals from an external device to the TV. Connect the external device and the TV with the component cable as shown on the following illustration. To display images by using progressive scan, make sure to use the component cable.

NOTE

- If cables are installed incorrectly, it could cause the image to display in black and white or with distorted color.
- **Check to ensure the cable are matched with the corresponding color connection.**

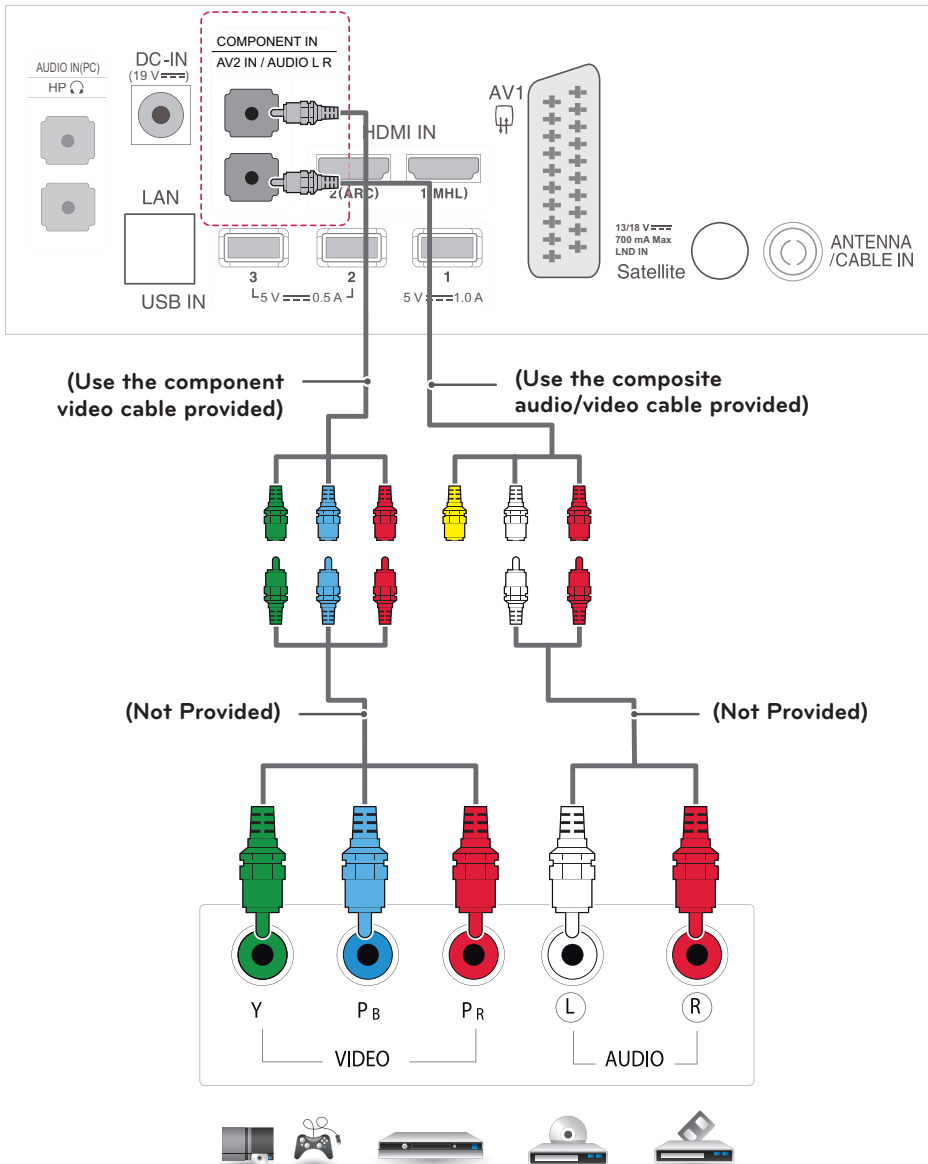

DVD / Blu-Ray / HD Cable Box /
HD STB / Gaming device

Composite connection

Transmits the analog video and audio signals from an external device to the TV. Connect the external device and the TV with the composite cable as shown on the following illustration.

NOTE

Check to ensure the cable are matched with the corresponding color connection.

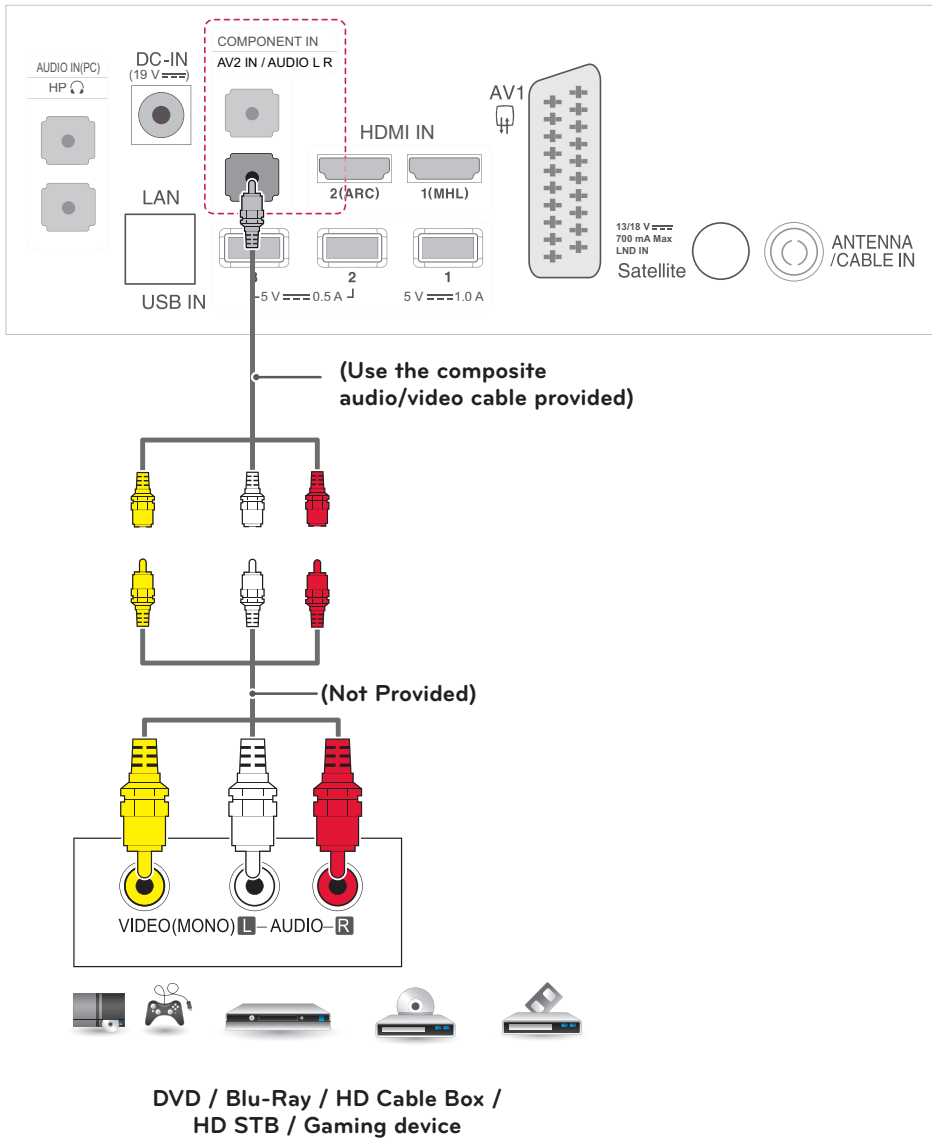

Euro Scart connection

Transmits the video and audio signals from an external device to the TV. Connect the external device and the TV with the Euro Scart cable as shown on the following illustration. To display images by using progressive scan, make sure to use the Euro Scart cable.

Output Type	AV1 (TV Out ¹)	AV1 (When DTV scheduled recording is in progress using recording equipment.)
Current input mode		
Digital TV	Digital TV	O
Analogue TV, AV	Analogue TV	O (The input mode is converted to DTV.)
Component		
HDMI		

1 TV Out : Outputs Analogue TV or Digital TV signals.

NOTE

- Any Euro scart cable used must be signal shielded.
- When watching digital TV in 3D imaging mode, TV out signals cannot be output through the SCART cable.
- If you set the 3D mode to On while a scheduled recording is performed on digital TV, monitor out signals cannot be output through the SCART cable, and the recording cannot be performed.

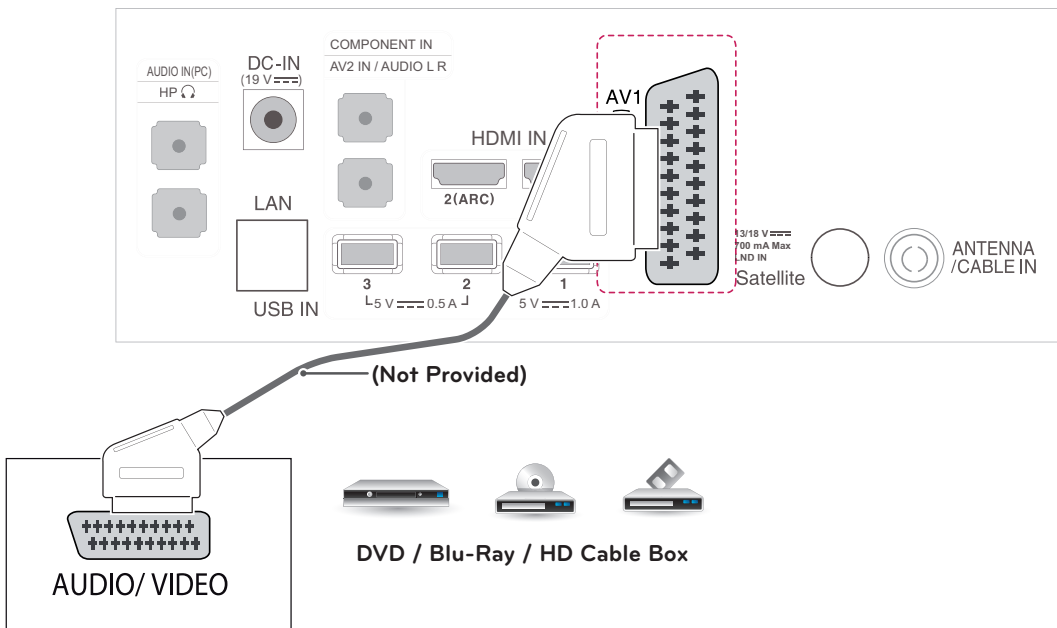

Headphone connection

Transmits the headphone signal from the TV to an external device. Connect the TV with the headphone as shown on the following illustration.

! NOTE

- AUDIO menu items are disabled when connecting a headphone.
- When changing AV MODE with a headphone connected, the change is applied to video but not to audio.
- Headphone impedance: 16 Ω
- Max audio output of headphone: 10 mW to 15 mW
- Headphone jack size: 0.35 cm

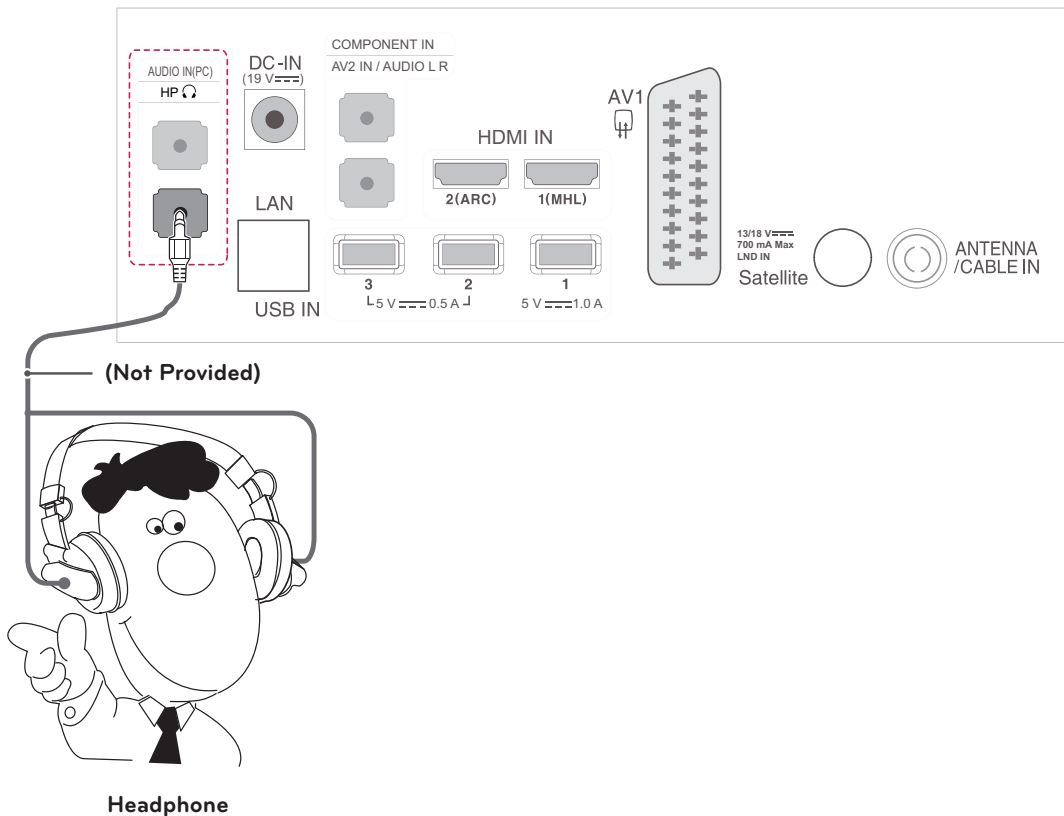

Connecting to a USB

Connect a USB storage device such as a USB flash memory, external hard drive, MP3 player or a USB memory card reader to the TV and access the USB menu to use various multimedia files.

! NOTE

- Some USB Hubs may not work. If a USB device connected using a USB Hub is not detected, connect it to the USB port on the TV directly.

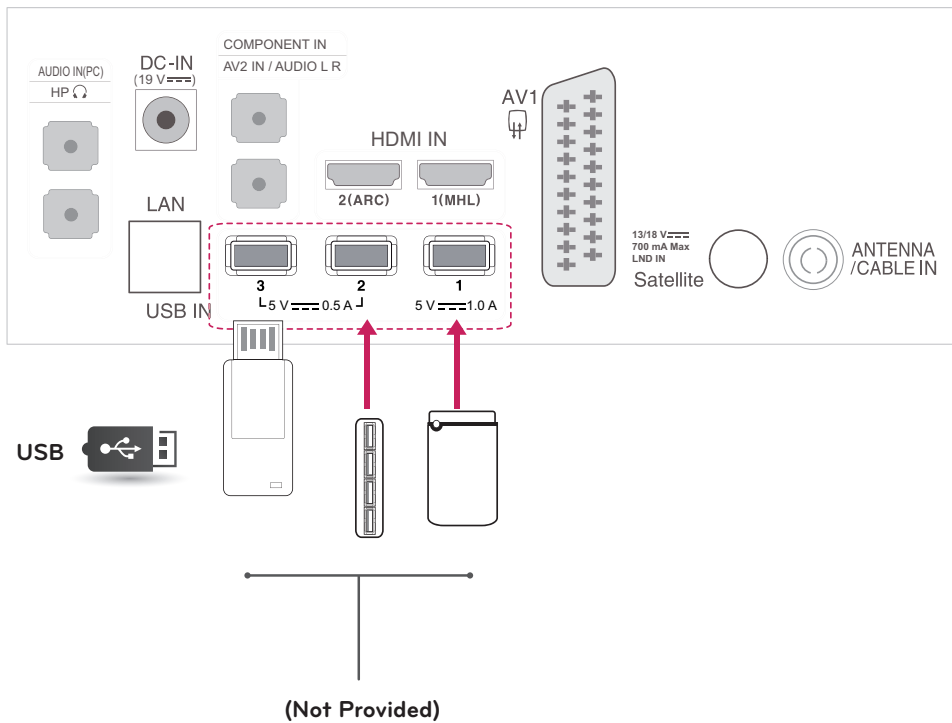

Connecting to a CI Module

View the encrypted (pay) services in digital TV mode. This feature is not available in all countries.

NOTE

- Check if the CI module is inserted into the PCMCIA card slot in the right direction. If the module is not inserted properly, this can cause damage to the TV and the PCMCIA card slot.
- If the TV does not display any video and audio when CI+ CAM is connected, please contact to the Terrestrial/Cable/Satellite Service Operator.

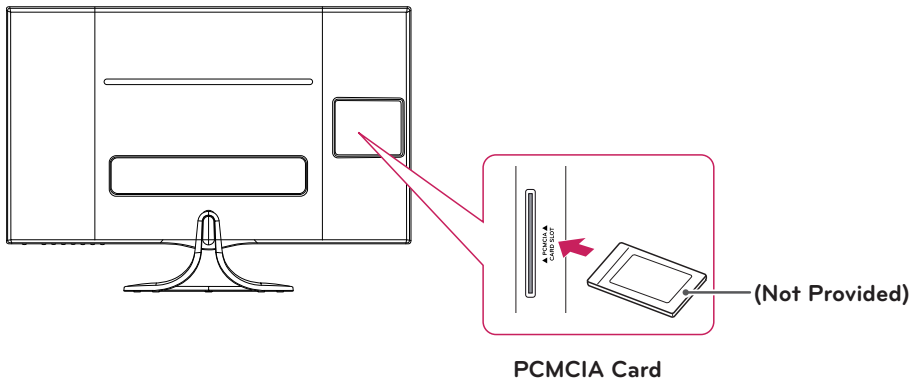

MHL connection

Mobile High-definition Link (MHL) is an interface for transmitting digital audiovisual signals from mobile phones to television sets.

! NOTE

- Connect the mobile phone to the HDMI IN 1(MHL) port to view the phone screen on the TV.
- The MHL passive cable is needed to connect the TV and a mobile phone.
- This only works for the MHL-enabled phone.
- Some applications can be operated by the remote control.
- For some mobile phones supporting MHL, you can control with the magic remote control.
- Remove the MHL passive cable from the TV when:
 - the MHL function is disabled
 - your mobile device is fully charged instandby mode

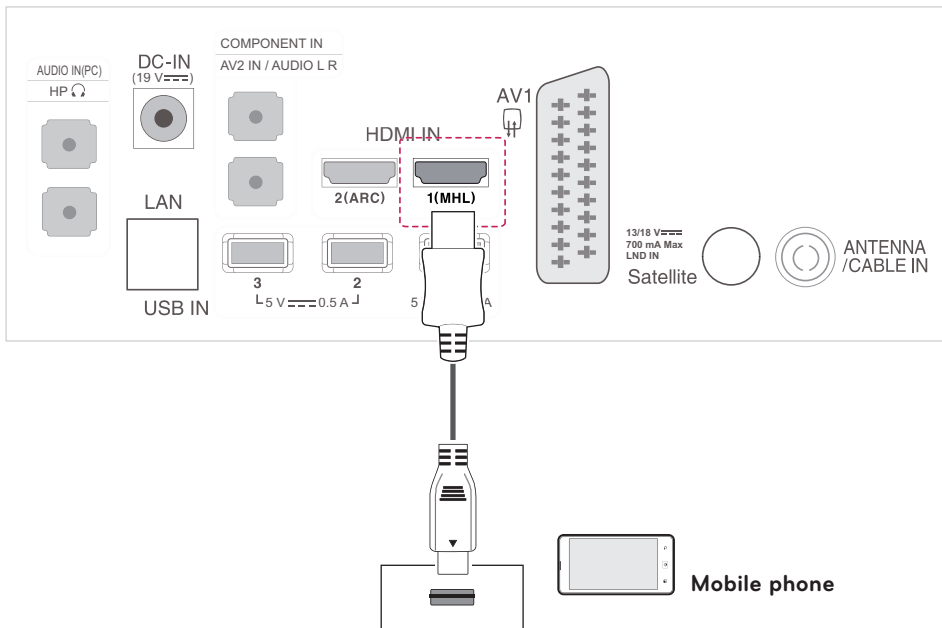

Connecting to a wired network

Connect the TV to a local area network (LAN) via the LAN port as shown on the following illustration and set up the network settings. After making a physical connection, a small number of home networks may require the TV network settings to be adjusted. For most home networks, the TV will connect to automatically without any adjustments.

For detail information, contact your internet provider or router manual.



CAUTION

- Do not connect a modular phone cable to the LAN port.
- Since there are various connection methods, please follow the specifications of your telecommunication carrier or internet service provider.

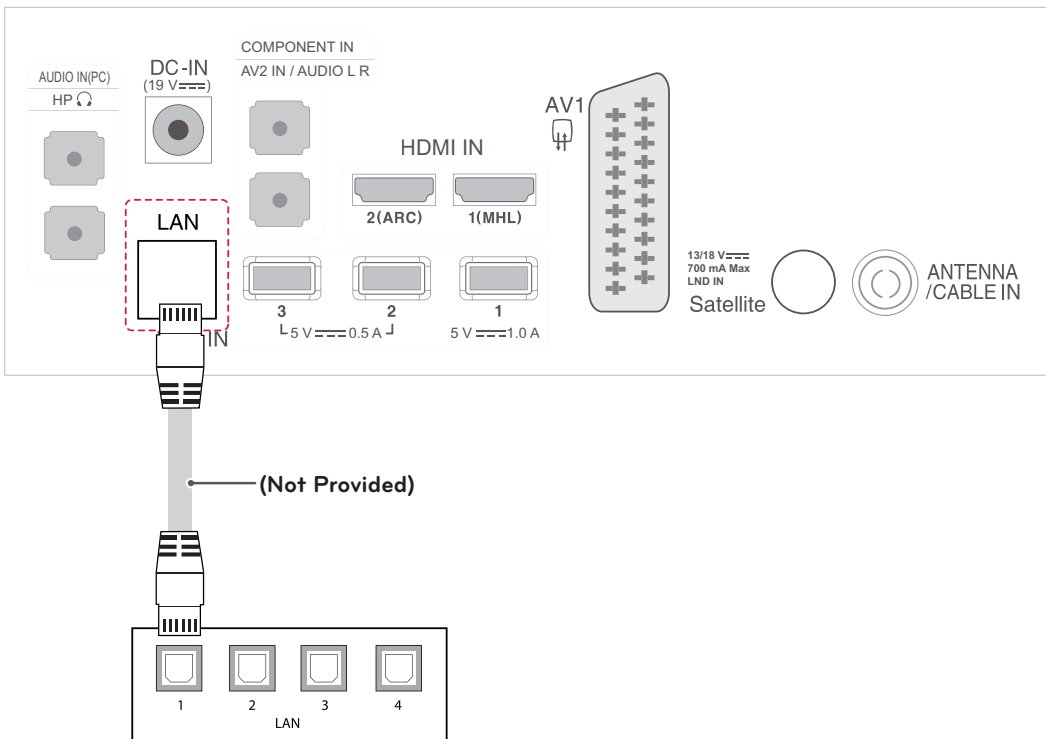

Connecting to a PC

Your TV supports the Plug & Play* feature and has the built-in speakers with Virtual Surround that reproduces sound clearly with a rich bass.

* Plug & Play: The function when a PC recognizes a connected device that users connect to a PC and turn on, without device configuration or user intervention.



NOTE

- It is recommended to use the TV with the HDMI connection for the best image quality.
- If you do not use an optional external speaker, connect the PC to the TV with the optional audio cable.
- If you turn the TV on when the set becomes cold, the screen may flicker. This is normal.
- Some red, green, or blue spots may appear on the screen. This is normal.
- Do not press the screen with your finger for a long time as this may result in temporary distortion on the screen.
- Avoid displaying a fixed image on the screen for a long period of time to prevent image burn. Use a screensaver if possible.
- If you want to use HDMI-PC mode, you must set the input label to PC mode.

HDMI connection

Transmits the digital video and audio signals from your PC to the TV. Connect the PC and the TV with the HDMI cable as shown in the following illustrations. You should set PC as an input label to connect the PC to the TV with an HDMI connection.

NOTE

- Use a High Speed HDMI™ Cable.
- High Speed HDMI™ Cables are tested to carry an HD signal up to 1080p and higher.
- If you want to use HDMI-PC mode, you must set the input label to PC mode.
- Supported DTV Audio: MPEG, Dolby Digital.
- Supported HDMI Audio format: DTS, Dolby Digital, PCM(Up to 192 KHz, 32k/44.1k/48k/88k/96k/176k/ 192k.)

- Choose any HDMI input port to connect.
- It does not matter which port you use.

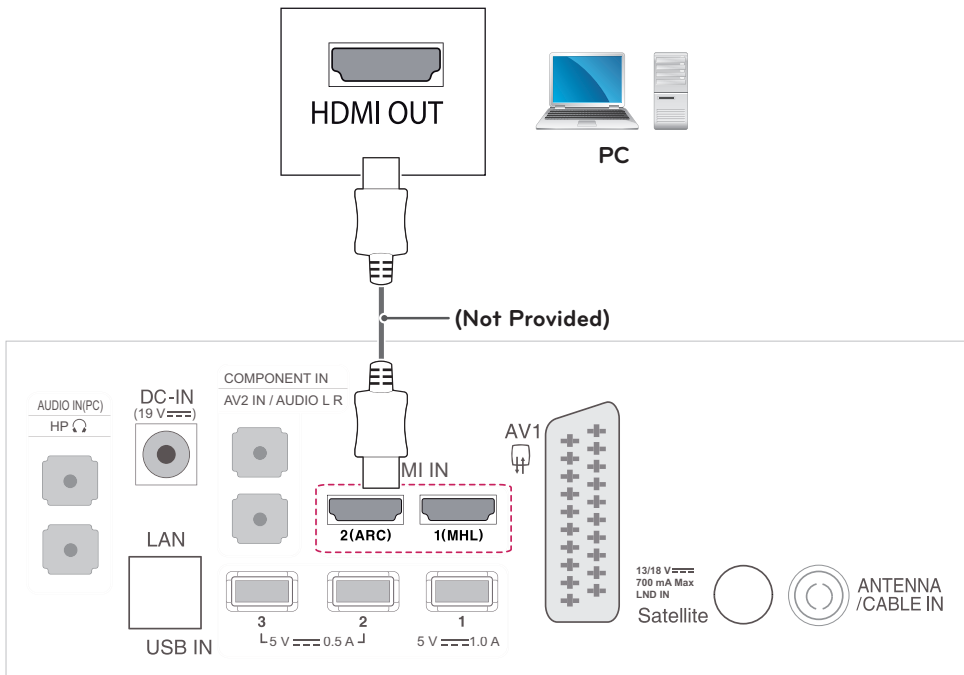

HDMI to DVI connection

Transmits the digital video signal from your PC to the TV. Connect the PC and the TV with the HDMI to DVI cable as shown the following illustrations. To transmit an audio signal, connect an optional audio cable.

NOTE

- If you want to use HDMI-PC mode, you must set the input label to PC mode.
- If you do not use an optional external speaker, connect the PC to the TV with the optional audio cable.

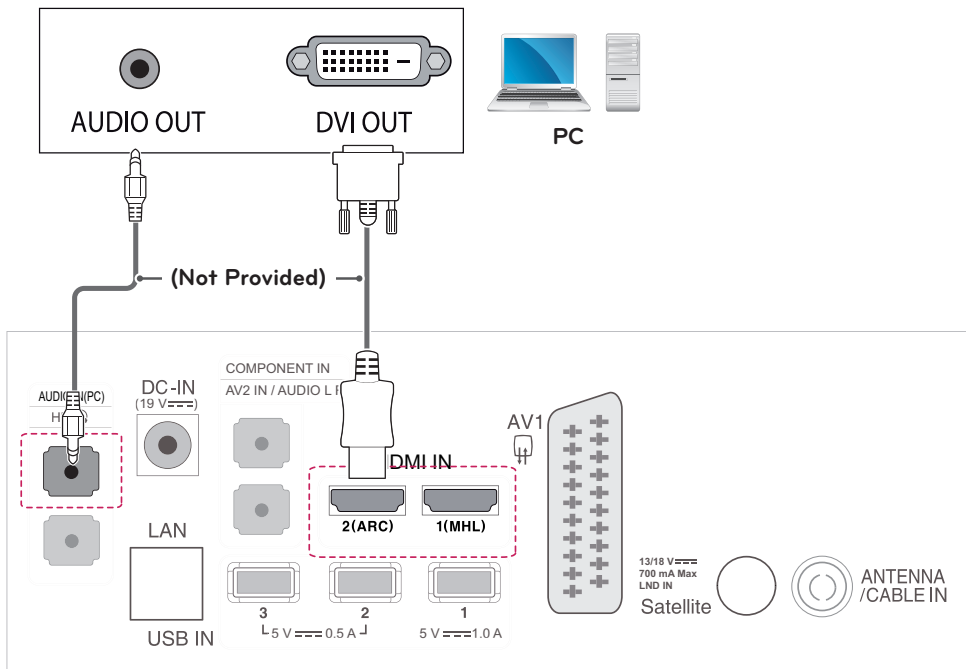

REMOTE CONTROL

The descriptions in this manual are based on the buttons of the remote control. Please read this manual carefully and use the TV correctly.

To replace batteries, open the battery cover, replace batteries (1.5 V AAA) matching ⊕ and ⊖ ends to the label inside the compartment, and close the battery cover.

To remove the batteries, perform the installation actions in reverse.



CAUTION

Do not mix old and new batteries, as this may damage the remote control.

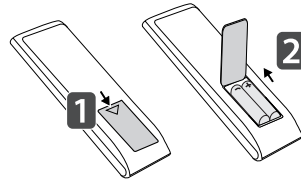

Make sure to point the remote control to the remote control sensor on the TV. Image shown may differ from your TV.

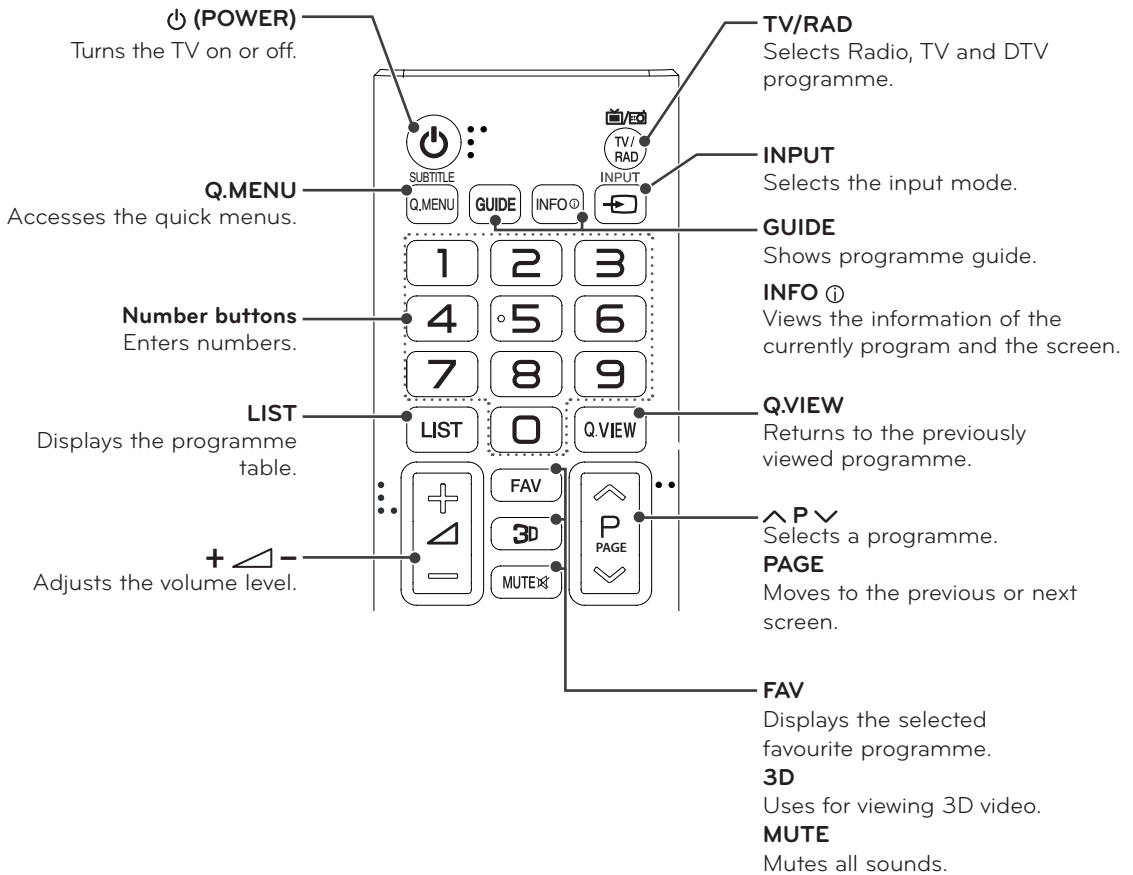

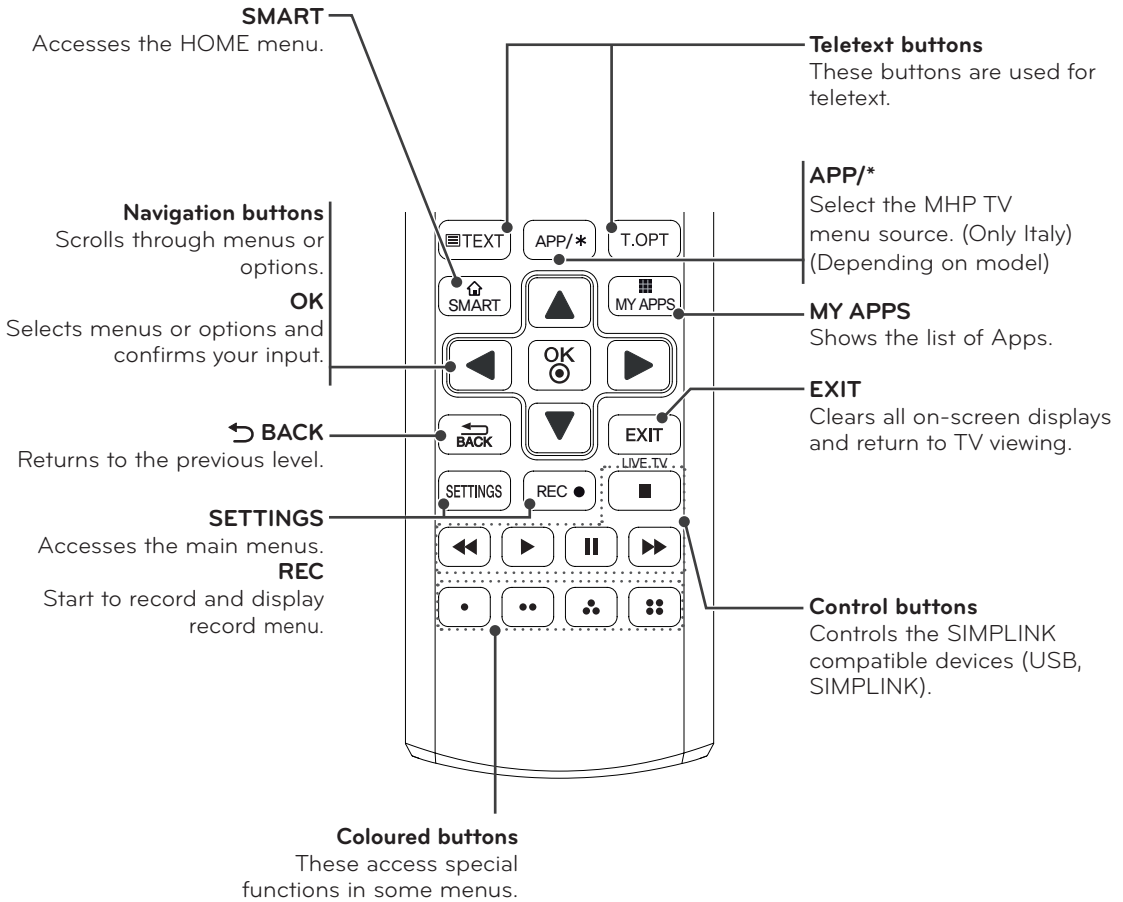

NOTE

On MHEG channel, you cannot adjust the backlight with the yellow or blue key.

MAGIC REMOTE CONTROL FUNCTIONS

When the message "Magic Remote Control battery is low. Change the battery." is displayed, replace the battery.

To replace batteries, open the battery cover, replace batteries (1.5 V AA) matching ⊕ and ⊖ ends to the label inside the compartment, and close the battery cover. Be sure to point the remote control toward the remote control sensor on the TV.

To remove the batteries, perform the installation actions in reverse.



CAUTION

Do not mix old and new batteries, as this may damage the remote control.

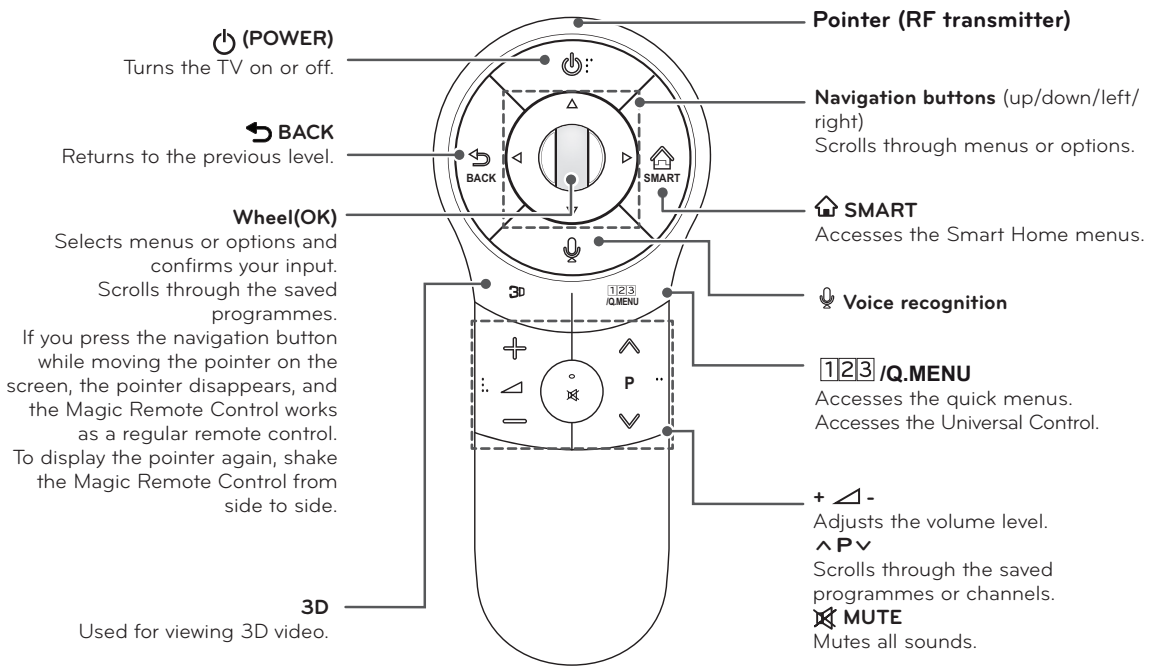
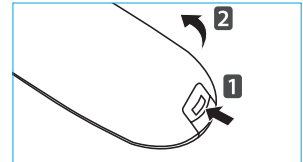

- | | |
|---|---|
| 1 | If you press Wheel(OK) on the Magic Remote Control, the following screen appears. Shows information about the current programmes and screen. |
| 2 | Pressing this button will display number keypad which you can select programme number. |
| 3 | You can select My Apps Menu. |

Registering Magic Remote Control

It is necessary to 'pair' (register) the magic remote control to your TV before it will work.

How to register the Magic Remote Control



- 1 To register automatically, turn the TV on and press the **Wheel(OK)** button. When registration is completed, the completion message appears on the screen.
- 2 If registration fails, turn the TV off and back on, then press the **Wheel(OK)** button to complete registration.

How to re-register the Magic Remote Control

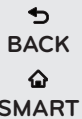

- 1 Press and hold the **BACK** and **SMART** buttons together for 5 seconds to reset, then register it by following "How to register the Magic Remote Control" above.
- 2 To re-register the Magic Remote Control, press and hold the **BACK** button for 5 seconds toward the TV. When registration is completed, the completion message appears on the screen.

How to use Magic Remote Control



- 1 If the pointer disappears, move the Magic Remote Control slightly to left or right. Then, it will automatically appear on the screen.
 - » If the pointer has not been used for a certain period of time, it will disappear.
- 2 You can move the pointer by aiming the Pointer Receiver of the Magic Remote Control at your TV then move it left, right, up or down.
 - » If the pointer does not work properly, leave the Magic Remote Control for 10 seconds then use it again.

Precautions to Take when Using the Magic Remote Control

- Use the Magic Remote Control within the maximum communication distance (10 m). Using the Magic Remote Control beyond this distance, or with an object obstructing it, may cause a communication failure.
- A communication failure may occur due to nearby devices. Electrical devices such as a microwave oven or wireless LAN product may cause interference, as these use the same bandwidth (2.4 GHz) as the Magic Remote Control.
- The Magic Remote Control may be damaged or may malfunction if it is dropped or receives a heavy impact.
- Take care not to bump into nearby furniture or other people when using the Magic Remote Control.
- Manufacturer and installer cannot provide service related to human safety as the applicable wireless device has possibility of electric wave interference.
- It is recommended that an Access Point (AP) be located more than 1 m away from the TV. If the AP is installed closer than 1 m, the Magic Remote Control may not perform as expected due to frequency interference.

USING THE USER GUIDE

User Guide allows you to more easily access the detailed TV information.



- 1 Press the **SMART**  button to access the Smart Home menu.
- 2 Select **User Guide** and press **Wheel(OK)**.



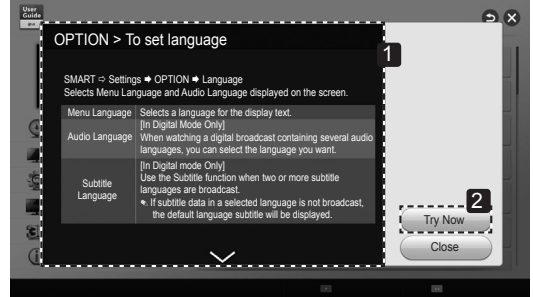

User Guide

- Image shown may differ from your TV.

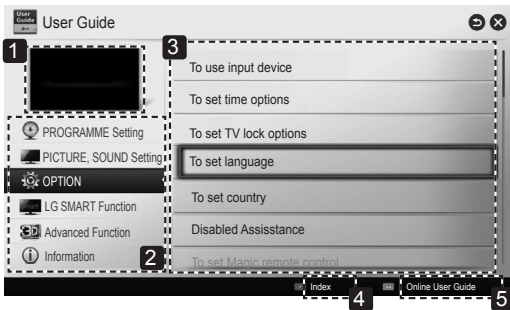

- 1 Shows the description of the selected menu. You can use   to move between pages.
- 2 Moves to the selected menu directly from the User Guide.



- 1 Shows the current watching programme or input source screen.
- 2 Allows to select the category you want.
- 3 Allows to select the item you want. You can use   to move between pages.
- 4 Allows to browse the description of the function you want from the index.
- 5 Provides the detailed information on the functions of LG Smart TV when the Internet is connected. (It may not be available depending on the country/language.)

MAINTENANCE

Cleaning Your TV

Clean your TV regularly to keep the best performance and to extend the product lifespan.



CAUTION

- Make sure to turn the power off and disconnect the power cord and all other cables first.
- When the TV is left unattended and unused for a long time, disconnect the power cord from the wall outlet to prevent possible damage from lightning or power surges.

Screen and frame

To remove dust, wipe the surface with a dry and soft cloth.

To remove major dirt, wipe the surface with a soft cloth dampened in clean water or a diluted mild detergent. Then wipe immediately with a clean and dry cloth.



CAUTION

- Do not push, rub, or hit the surface with your fingernail or a sharp object, as this may result in scratches on the screen and image distortions.
- Do not use any chemicals, such as waxes, benzene, alcohol, thinners, insecticides, air fresheners, lubricants, as these may damage the screen's finish and cause discolorations.

Cabinet and stand

To remove dust, wipe the cabinet with a dry and soft cloth.

To remove major dirt, wipe the cabinet with a soft cloth dampened in a clean water or water containing a small amount of mild detergent.



CAUTION

- Do not spray liquid onto the surface. If water enters the TV, it may result in fire, electric shock, or malfunction.
- Do not use any chemicals as this may deteriorate the surface.

Power cord

Remove the accumulated dust or dirt on the power cord regularly.

Preventing "Image burn" or "Burn-in" on your TV screen

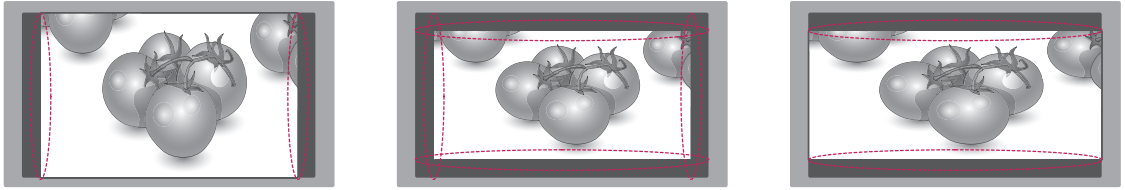

- If a fixed image displays on the TV screen for a long period of time, it will be imprinted and become a permanent disfigurement on the screen. This is "image burn" or "burn-in" and not covered by the warranty.
- If the aspect ratio of the TV is set to 4:3 for a long period of time, image burn may occur on the letterboxed area of the screen.
- Avoid displaying a fixed image on the TV screen for a long period of time (2 or more hours for LCD/LED) to prevent image burn.

IF THE QUALITY OF THE 3D IMAGE IS NOT ACCEPTABLE, CHECK THE FOLLOWING

1) Viewing distance

For optimal 3D viewing distance, please see the table below.
Please maintain the optimal viewing distance for the best 3D experience.

2) Viewing angle

For optimal 3D viewing angles, see the table below.

3) Check the 3D display sequence (L-R, R-L)

The display method may vary due to the 3D content type. Try changing the display method to L-R or R-L for a better viewing experience

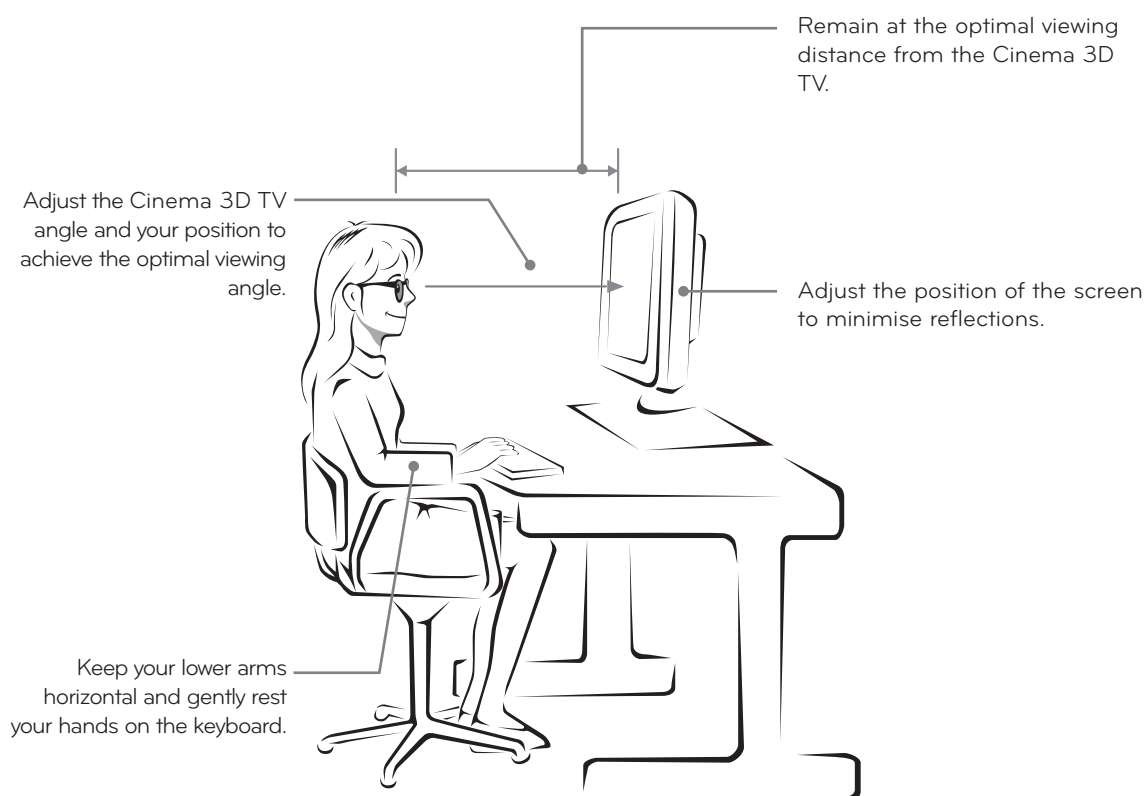

Model	Mode	Dimension	Monitor's allowed 3D viewing distance	Monitor's optimal 3D viewing distance	Optimal viewing angle
27MT93V 27MT93S	When viewing 3D images	69.0 cm	55 cm to 500 cm	100 cm	12 °

VIEWING 3D IMAGING



WARNING

Viewing Environment

- Viewing Time
 - When watching 3D contents, take 5 - 15 minute breaks every hour. Viewing 3D contents for a long period of time may cause headache, dizziness, fatigue or eye strain.

Viewing Age

- Infants/Children
 - Usage/ Viewing 3D contents for children under the age of 5 are prohibited.
 - Children under the age of 10 may overreact and become overly excited because their vision is in development (for example: trying to touch the screen or trying to jump into it. Special monitoring and extra attention is required for children watching 3D contents.
 - Children have greater binocular disparity of 3D presentations than adults because the distance between the eyes is shorter than one of adults. Therefore they will perceive more stereoscopic depth compared to adults for the same 3D image.
- Teenagers
 - Teenagers under the age of 19 may react with sensitivity due to stimulation from light in 3D contents. Advise them to refrain from watching 3D contents for a long time when they are tired.
- Elderly
 - The elderly may perceive less 3D effect compared to the youth. Do not sit closer to the TV than the recommended distance.

Those that have a photosensitive seizure or chronic illness

- Some users may experience a seizure or other abnormal symptoms when they are exposed to a flashing light or particular pattern from 3D contents.
- Do not watch 3D videos if you feel nausea, are pregnant and/ or have a chronic illness such as epilepsy, cardiac disorder, or blood pressure disease, etc.
- 3D Contents are not recommended to those who suffer from stereo blindness or stereo anomaly. Double images or discomfort in viewing may be experienced.
- If you have strabismus (cross-eyed), amblyopia (weak eyesight) or astigmatism, you may have trouble sensing depth and easily feel fatigue due to double images. It is advised to take frequent breaks than the average adult.
- If your eyesight varies between your right and left eye, revise your eyesight prior to watching 3D contents.

Symptoms which require discontinuation or refraining from watching 3D contents

- Do not watch 3D contents when you feel fatigue from lack of sleep, overwork or drinking.
- When these symptoms are experienced, stop using/watching 3D contents and get enough rest until the symptom subsides.
 - Consult your doctor when the symptoms persist. Symptoms may include headache, eyeball pain, dizziness, nausea, palpitation, blurriness, discomfort, double image, visual inconvenience or fatigue.



CAUTION

Viewing Environment

- Viewing Distance
 - Maintain a distance of at least twice the screen diagonal length when watching 3D contents. If you feel discomfort in viewing 3D contents, move further away from the TV.

Cautions when using the 3D glasses

- Make sure to use LG 3D glasses. Otherwise, you may not be able to view 3D videos properly.
- Do not use 3D glasses instead of your normal glasses, sunglasses or protective goggles.
- Using modified 3D glasses may cause eye strain or image distortion.
- Do not keep your 3D glasses in extremely high or low temperatures. It will cause deformation.
- The 3D glasses are fragile and are easy to be scratched. Always use a soft, clean piece of cloth when wiping the lenses. Do not scratch the lenses of the 3D glasses with sharp objects or clean/wipe them with chemicals.

TROUBLESHOOTING

General

Problem	Resolution
Cannot control the TV with the remote control.	<ul style="list-style-type: none"> • Check the remote control sensor on the product and try again. • Check if there is any obstacle between the product and the remote control. • Check if the batteries are still working and properly installed (⊕ to ⊕, ⊖ to ⊖).
No image display and no sound is produced.	<ul style="list-style-type: none"> • Check if the product is turned on. • Check if the power cord is connected to a wall outlet. • Check if there is a problem in the wall outlet by connecting other products.
The TV turns off suddenly.	<ul style="list-style-type: none"> • Check the power control settings. The power supply may be interrupted. • Check if the Auto sleep feature is activated in the Time settings. • If there is no signal while the TV is on, the TV will turn off automatically after 15 minutes of inactivity.

Using 3D mode

Problem	Resolution
If you can see a swirling oil-like pattern on the TV when the TV is turned off.	This is caused by the interference of external light in the air layer between the LCD/LED surface and 3D filter. The pattern becomes almost invisible when you turn on the power again.
If you are not using the glasses provided with the TV.	When you view 3D images with this TV, it is very important that you use the glasses provided with the TV. The glasses are designed to compensate optically for the 3D filter attached to the surface of the TV. If you wear third-party glasses, you may not see 3D images properly on the TV.
If you view 3D images outside the optimal viewing angle or distance.	When you view 3D images outside the optimal viewing angle or viewing distance, the images may look overlapped or not be displayed properly in 3D.

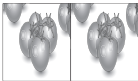
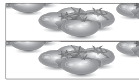

Notes for Viewing 3D Image with 3D Digital Brodcatng

***In Analogue Brodcatng, 3D Imaging does not work.**

Problem	Resolution
When switching the 2D image display to the 3D image display with the 3D button on the remote control, the overlapped image may be displayed.	<ul style="list-style-type: none"> • Disable the 3D imaging mode with the 3D button.
If the screen is divided into left/right or top/bottom when you change the channel	This channel supports the 3D imaging mode. Select the 3D imaging type displayed on the screen by pressing the 3D button on the remote control.
 	
If your eyes are sore or the screen looks blurry while viewing 3D images.	Select Left/Right or Right/Left option, which you find better for viewing 3D images.

SPECIFICATIONS

Product specifications may be changed without prior notice due to upgrade of product functions.

Wireless LAN module(TWFM-B006D) specification	
Standard	IEEE802.11a/b/g/n
Frequency Range	2400 to 2483.5 MHz 5150 to 5250 MHz
Modulation	CCK / OFDM / MIMO
Output Power (Typical)	802.11a: 11 dBm 802.11b: 15 dBm 802.11g: 13 dBm 802.11n - 2.4GHz: 13 dBm 802.11n - 5GHz: 13 dBm
Data rate	802.11a/g: 54 Mbps 802.11b: 11 Mbps 802.11n: 300 Mbps
Antenna Gain (Typical)	2400 to 2483.5 MHz: 2.5dBi 5150 to 5250 MHz: 2.2dBi
Occupied bandwidth	802.11a/b/g: HT20 802.11n: HT20/40
<ul style="list-style-type: none"> Because band channel used by the country could be different, the user can not change or adjust the operating frequency and this product is set for the regional frequency table. 	
	
Bluetooth module (BM-LDS401) specification	
Standard	Bluetooth Version 3.0
Frequency Range	2400 ~ 2483.5 MHz
Output Power (Max.)	10 dBm or lower
Data rate (Max.)	3 Mbps
Communication Distance	Line of Open Sight approx. 10 m
	

	Digital TV	Analogue TV
Television system	DVB-T(*DVB-T/T2) DVB-C DVB-S/S2	PAL/SECAM B/G/I/D/K SECAM L/L'
Programme coverage	VHF, UHF C-Band, Ku-Band	VHF: E2 to E12, UHF : E21 to E69, CATV: S1 to S20, HYPER: S21 to S47
Maximum number of storable programmes	DVB-S/S2 : 6,000 DVB-T/T2/C & Analogue TV : 1,500	

* : Only DVB-T2 support models

Panel	Screen Type	690 mm Wide (27 inch) Visible diagonal size : 690 mm
	Pixel Pitch	0.3114 mm (H) x 0.3114 mm (V)
Video Signal	Max. Resolution	1920 × 1080 @ 60 Hz
	Recommended Resolution	1920 × 1080 @ 60 Hz
	Horizontal Frequency	30 kHz to 83 kHz
	Vertical Frequency	58 Hz to 62 Hz
	Synchronization Type	Digital
Input Connector		TV, PC Audio In, Component, AV1(SCART), AV2(CVBS), HDMI*2, USB*3, PCMCIA, LAN JACK
Power	Rated Voltage	19 V --- 3.2 A
	Power Consumption	On Mode : 38 W (typ.) Off Mode ≤ 0.5 W
AC/DC Adapter		Manufacturer: LG Innotek, Model PSAB-L206A
Tilt	Tilt Range	-5 to 20°
Dimensions (Width x Depth x Height)		With Stand
Weight		622.1 mm x 208.4 mm x 437.8 mm 5.2 kg
		Without Stand
		622.1 mm x 66.8 mm x 373.7 mm 4.7 kg
Environmental conditions	Operating Temperature	10 °C to 35 °C
	Operating Humidity	20 % to 80 %
	Storage Temperature	-10 °C to 60 °C
	Storage Humidity	5 % to 90 %

Product specifications shown above may be changed without prior notice due to upgrade of product functions.

HDMI (PC) supported mode

Resolution	Horizontal Frequency(kHz)	Vertical Frequency(Hz)
640 x 350	31.468	70.090
720 x 400	31.469	70.080
640 x 480	31.469	59.940
800 x 600	37.879	60.317
1024 x 768	48.363	60.004
1152 x 864	54.348	60.053
1360 x 768	47.712	60.015
1280 x 1024	63.981	60.020
1920 x 1080	67.500	60.000

HDMI (DTV) supported mode

Resolution	Horizontal Frequency(kHz)	Vertical Frequency(Hz)
720X480	31.469	59.940
	31.500	60.000
720X576	31.250	50.000
1280X720	37.500	50.000
	44.960	59.940
	45.000	60.000
1920X1080	33.720	59.940
	33.750	60.000
	28.125	50.000
	26.970	23.970
	27.000	24.000
	33.716	29.976
	33.750	30.000
	56.250	50.000
	67.430	59.940
	67.500	60.000

Component port connecting information

Component ports on the TV	Y	P _B	P _R
---------------------------	---	----------------	----------------

Video output ports on DVD player	Y	P _B	P _R
	Y	B-Y	R-Y
	Y	Cb	Cr
	Y	Pb	Pr

Signal	Component
480i/576i	○
480p/576p	○
720p/1080i	○
1080p	○ (50 Hz / 60 Hz only)

**NOTE**

- Avoid keeping a fixed image on the set's screen for prolonged periods of time. The fixed image may become permanently imprinted on the screen. Use a screen saver when possible.
- There may be interference relating to resolution, vertical pattern, contrast or brightness in PC mode. Change the PC mode to another resolution or change the refresh rate to another rate or adjust the brightness and contrast on the menu until the picture is clear. If the refresh rate of the PC graphic card can not be changed, change the PC graphic card or consult the manufacturer of the PC graphic card.
- The synchronization input waveform for Horizontal and Vertical frequencies are separate.
- Connect the audio cable from the PC to the Audio input on the TV. (Audio cables are not included with the TV).
- If using a sound card, adjust PC sound as required.
- DOS mode may not work depending on the video card if you use an HDMI to DVI cable.

3D supported mode

- Video, which is input as below media contents is switched into the 3D screen automatically.
- The method for 3D digital broadcast may differ depending on the signal environment. If video is not switched automatically into 3D, manually convert the settings to view 3D images.

3D supported mode automatically					
Input	Signal	Horizontal Frequency (kHz)	Vertical Frequency (Hz)	Playable 3D video format	
HDMI	640 X 480	31.469 / 31.5	59.94 / 60	Top & Bottom, Side by Side(Half), Side by Side(Full)	
		62.938 / 63		Frame Packing, Line Alternative	
	480p	31.469 / 31.5		Top & Bottom, Side by Side(Half), Side by Side(Full)	
		62.938 / 63		Frame Packing, Line Alternative	
	576p	31.25	50	Top & Bottom, Side by Side(Half), Side by Side(Full)	
		62.5		Frame Packing, Line Alternative	
	720p	37.50	50	Top & Bottom, Side by Side(Half), Side by Side(Full)	
		44.96 / 45	59.94 / 60		
		75	50	Frame Packing, Line Alternative	
		89.91 / 90	59.94 / 60		
	1080i	28.125	50	Top & Bottom, Side by Side(Half), Side by Side(Full)	
		33.72 / 33.75	59.94 / 60		
		56.25	50	Frame Packing, Field Alternative	
		67.5	59.94 / 60		
	1080p	26.97 / 27	23.97 / 24	Top & Bottom, Side by Side(Half), Side by Side(Full)	
		28.125	25		
		33.72 / 33.75	29.976 / 30		
		43.94 / 54	23.97 / 24	Frame Packing, Line Alternative	
		56.25	25		
		67.432 / 67.5	29.976 / 30		
		56.25	50		
		67.432 / 67.5	59.94 / 60	Top & Bottom, Side by Side(Half)	
	USB	1080p	33.75	30	Side by Side(Half), Top & Bottom, Checker Board, MPO(Photo), JPS(Photo)
	DLNA	1080p	33.75	30	
	Signal			Playable 3D video format	
DTV	Frame Compatible			Side by Side(Half), Top & Bottom	

3D supported mode manually				
Input	Signal			Playable 3D video format
	Resolution	Horizontal Frequency (kHz)	Vertical Frequency (Hz)	
DTV	HD / SD	-	-	2D to 3D, Side by Side(Half), Top & Bottom
ATV(CVBS/SCART)	SD	-	-	
Component	HD / SD	-	-	
HDMI-PC	1024X768	48.36	60	2D to 3D, Side by Side(Half), Top & Bottom, Checker Board, Frame Sequential, Row Interleaving, Column Interleaving
	1360X768	47.71		
	1920X1080	67.5	-	2D to 3D, Side by Side(Half), Top & Bottom
	Others	-	-	2D to 3D, Side by Side(Half), Top & Bottom
HDMI-DTV	480P	31.5	60	2D to 3D, Side by Side(Half), Top & Bottom, Checker Board, Frame Sequential, Row Interleaving, Column Interleaving
	576P	31.25	50	
	720p	37.5	50	
		45	60	
	1080i	28.12	50	2D to 3D, Side by Side(Half), Top & Bottom
		33.75	60	
	1080p	27	24	2D to 3D, Side by Side(Half), Top & Bottom, Checker Board, Row Interleaving, Column Interleaving
		28.12	25	
		33.75	30	
		56.25	50	2D to 3D, Side by Side(Half), Top & Bottom, Checker Board, Frame Sequential, Row Interleaving, Column Interleaving
67.5	60			
USB ,DLNA (Movie)	Under 704x480	-	-	2D to 3D
	Over 704x480 interlaced	-	-	2D to 3D, Side by Side(Half), Top & Bottom
	Over 704x480 progressive	-	50 / 60	2D to 3D, Side by Side(Half), Top & Bottom, Checker Board, Row Interleaving, Column Interleaving, Frame Sequential
	Over 704x480 progressive	-	others	2D to 3D, Side by Side(Half), Top & Bottom, Checker Board, Row Interleaving, Column Interleaving
USB, DLNA (Photo)	Under 320x240	-	-	2D to 3D
	Over 320x240	-	-	2D to 3D, Side by Side(Half), Top & Bottom
Miracast/Widi	1024X768p	-	30 / 60	2D to 3D, Side by Side(Half), Top & Bottom
	1280x720p	-	30 / 60	
	1920X1080p	-	30 / 60	
	Others	-	-	2D to 3D



Make sure to read the Safety Precautions before using the product.

Keep the Owner's Manual (CD) in an accessible place for future reference.

The model and serial number of the TV is located on the back and one side of the TV. Record it below should you ever need service.

MODEL _____

SERIAL _____

To obtain the source code under GPL, LGPL, MPL and other open source licenses, that is contained in this product, please visit <http://opensource.lge.com>.

In addition to the source code, all referred license terms, warranty disclaimers and copyright notices are available for download. LG Electronics will also provide open source code to you on CD-ROM for a charge covering the cost of performing such distribution (such as the cost of media, shipping and handling) upon email request to opensource@lge.com. This offer is valid for three (3) years from the date on which you purchased the product.