



OWNER'S MANUAL WASHING MACHINE

Please read this manual carefully before operating your washing machine and retain it for future reference.

WT-R10686



P/No.: MFL67221369

www.lg.com

INTRODUCTION

IMPORTANT SAFETY INSTRUCTIONS

Basic safety precautions	3-4
Grounding instructions	4
Safety instructions for installation	5
Safety instructions for use, care and cleaning, and disposal	6

PARTS AND FEATURES

Special Features	7
Key Parts and Components	8

INSTALLATION INSTRUCTIONS

Choose the Proper Location	9
Flooring	9
Clearances	9
Unpack the Washer	10
Connecting the Water Lines	11
Connecting the Drain Line	11-12
Leveling the Washer	12
Connect to the Power Supply	12

HOW TO USE

Control Panel Features	13
Operating the Washer	14
Cycle Guide	15
Information For Energy Test	16
Sorting Wash Loads	16
About the Dispenser	17
Loading the Dispenser	18
The LED Display	19
Cycle Modifier Buttons	20
Cycle Option Buttons	21-22

CARE AND CLEANING

Regular Cleaning	23-24
Maintenance	24
Cleaning the Washer	25

TROUBLESHOOTING

Normal Sounds You May Hear	26
Before Calling for Service	26-30
SmartDiagnosis™	31

SPECIFICATION

Specification	32
---------------------	----

THANK YOU!

Congratulations on your purchase

and welcome to the LG family.

Your new LG washing machine

combines the most advanced
washing technology with simple
operation and high efficiency.

Follow the operating and care
instructions in this manual, and your
washer will provide many years of
reliable service.



IMPORTANT SAFETY INSTRUCTIONS

READ ALL INSTRUCTIONS BEFORE USE

⚠ WARNING For your safety, the information in this manual must be followed to minimize the risk of fire or explosion, electric shock, or to prevent property damage, personal injury, or loss of life.

Your safety and the safety of others is very important.

We have provided many important safety messages in this manual and on your appliance. Always read and obey all safety messages.



This is the safety alert symbol.

This symbol alerts you to potential hazards that can kill or hurt you and others.

All safety messages will follow the safety alert symbol and either the word DANGER or WARNING.

These words mean:

⚠ DANGER: You can be killed or seriously injured if you don't immediately follow instructions.

⚠ WARNING: You can be killed or seriously injured if you don't follow instructions.

⚠ CAUTION: You may be slightly injured or cause damage to the product if you do not follow instructions. All safety messages will tell you what the potential hazard is, tell you how to reduce the chance of injury, and tell you what can happen if the instructions are not followed.

BASIC SAFETY PRECAUTIONS

⚠ WARNING: To reduce the risk of fire, electric shock, or personal injury when using this appliance, follow basic precautions, including the following.

- Use this appliance only for its intended purpose as described in this owner's Manual.
- Before use, the washer must be properly installed as described in this manual.
- Do not wash articles that have been previously cleaned in, washed in, soaked in, or spotted with gasoline, dry cleaning solvents, or other flammable or explosive substances, as they give off vapors that could ignite or explode.
- Do not add gasoline, dry cleaning solvents, or other flammable or explosive substances to the wash water. These substances give off vapors that could ignite or explode.
- Under certain conditions, hydrogen gas may be produced in a hot water system that has not been used for 2 weeks or more. **HYDROGEN GAS IS EXPLOSIVE.** If the hot water system has not been used for such a period, before using the washer, turn on all hot water faucets and let the water flow from each for several minutes. This will release any accumulated hydrogen gas. As the gas is flammable, do not smoke or use an open flame during this time.
- Do not allow children to play on or in the washer. Close supervision of children is necessary when the washer is used near children.
- Before the washer is removed from service or discarded, remove the lid to prevent children from climbing inside.
- Do not install or store the washer where it will be exposed to the weather or freezing temperatures.
- Do not tamper with controls.
- Keep the area underneath and around your appliances free of combustible materials (lint, paper, rags, etc.), gasoline, chemicals and other flammable vapors and liquids.
- Do not repair or replace any part of the washer or attempt any servicing other than as described in this manual. We strongly recommend that any service be performed by a qualified individual.
- See **Installation Instructions** for grounding requirements.
- ALWAYS follow the fabric care instructions supplied by the garment manufacturer.
- Do not place items exposed to cooking oil in your washer. Items contaminated with cooking oils may contribute to a chemical reaction that could cause a load to catch fire.
- Use fabric softeners or products to eliminate static only as recommended by the manufacturer.
- This washer is not designed for maritime use or for mobile installations such as in RVs, aircraft, etc.
- Turn off the water taps and unplug the washer if the machine is to be left for an extended period of time, such as during vacations.
- Do not use to dry articles containing foam rubber or similarly textured rubber-like materials.
- Packaging material can be dangerous for children. There is a risk of suffocation! Keep all packaging from children.
- Always check the inside of the washer for foreign objects before loading laundry. Keep the lid closed when not in use.
- Do not reach into the washer while parts are moving.

IMPORTANT SAFETY INSTRUCTIONS

READ ALL INSTRUCTIONS BEFORE USE

⚠WARNING For your safety, the information in this manual must be followed to minimize the risk of fire or explosion, electric shock, or to prevent property damage, personal injury, or loss of life.

GROUNDING INSTRUCTIONS

This appliance must be grounded. In the event of malfunction or breakdown, grounding will reduce the risk of electric shock by providing a path of least resistance for electric current. This appliance is equipped with a cord having an equipment-grounding conductor and grounding plug. The plug must be plugged into an appropriate outlet that is properly installed and grounded in accordance with all local codes and ordinances.

⚠WARNING: Improper connection of the equipment-grounding conductor can result in risk of electric shock. Check with a qualified electrician or serviceman if you are in doubt as to whether the appliance is properly grounded. Do not modify the plug provided with the appliance. If it does not fit the outlet, have a proper outlet installed by a qualified electrician. Failure to follow these warnings can cause serious injury, fire, electrical shock, or death.

IMPORTANT SAFETY INSTRUCTIONS

READ ALL INSTRUCTIONS BEFORE USE

⚠WARNING For your safety, the information in this manual must be followed to minimize the risk of fire or explosion, electric shock, or to prevent property damage, personal injury, or loss of life.

SAFETY INSTRUCTIONS FOR INSTALLATION

⚠WARNING: To reduce the risk of fire, electric shock, or personal injury when using this appliance, follow basic precautions, including the following.

- **Refer to INSTALLATION INSTRUCTIONS for detailed grounding procedures.** Installation instructions are packed in the washer for installer's reference. If the washer is moved to a new location, have it checked and reinstalled by a qualified service person. Failure to follow this warning can cause serious injury, fire, electrical shock, or death.
- **Do not, under any circumstances cut or remove the third (ground) prong from the power cord.** Failure to follow this warning can cause serious injury, fire, electrical shock, or death.
- **For personal safety, this appliance must be properly grounded.** Failure to follow this warning can cause serious injury, fire, electrical shock, or death.
- **The power cord of this appliance is equipped with a 3-prong (grounding) plug which mates with a standard 3-prong (grounding) wall outlet** to minimize the possibility of electric shock hazard from this appliance.
- **This washer must be plugged into a 220-240V AC/ 50Hz grounded outlet.** Failure to follow this warning can cause serious injury, fire, electrical shock, or death.
- **Have the wall outlet and circuit checked by a qualified electrician to make sure the outlet is properly grounded.** Failure to follow this warning can cause serious injury, fire, electrical shock, or death.
- **Where a standard 2-prong wall outlet is encountered, it is your personal responsibility and obligation to have it replaced with a properly grounded 3-prong wall outlet.** Failure to follow this warning can cause serious injury, fire, electrical shock, or death.
- **Do not install on carpet. Install washer on a solid floor.** Failure to follow this warning can cause serious leak damage.
- **Do not remove ground prong. Do not use an adapter or extension cord. Plug into a grounded 3-prong outlet.** Failure to follow these warnings can cause serious injury, fire, electrical shock, or death.
- **The washer should always be plugged into its own individual electrical outlet which has a voltage rating that matches the rating plate.** This provides the best performance and also prevents overloading house wiring circuits which could cause a fire hazard from overheated wires.
- **Never unplug your washer by pulling on the power cord.** Always grip plug firmly and pull straight out from the outlet. Failure to follow this warning can cause serious injury, fire, electrical shock, or death.
- **Repair or replace immediately all power cords that have become frayed or otherwise damaged. Do not use a cord that shows cracks or abrasion damage along its length or at either end.** Failure to follow this warning can cause serious injury, fire, electrical shock, or death.
- **When installing or moving the washer, be careful not to pinch, crush, or damage the power cord.** Failure to follow this warning can cause serious injury, fire, electrical shock, or death.
- **The washer must be installed and electrically grounded by a qualified service person in accordance with local codes** to prevent shock hazard and assure stability during operation.
- **The washer is heavy. Two or more people may be needed to install and move the appliance.** Failure to do so can result in back or other injury.
- **Store and install the washer where it will not be exposed to temperatures below freezing or exposed to outdoor weather conditions.** Failure to follow this warning can cause serious leak damage.
- **Do not install the washer in humid spaces to reduce the risk of electric shock.** Failure to follow this warning can cause serious injury, fire, electrical shock, or death.
- **To reduce the risk of personal injury, adhere to all industry recommended safety procedures including the use of long sleeved gloves and safety glasses.** Failure to follow all of the safety warnings in this manual could result in property damage, personal injury or death.

IMPORTANT SAFETY INSTRUCTIONS

READ ALL INSTRUCTIONS BEFORE USE

⚠WARNING For your safety, the information in this manual must be followed to minimize the risk of fire or explosion, electric shock, or to prevent property damage, personal injury, or loss of life.

SAFETY INSTRUCTIONS FOR USE, CARE AND CLEANING, AND DISPOSAL

⚠WARNING: To reduce the risk of fire, electric shock, or personal injury when using this appliance, follow basic precautions, including the following.

- **Unplug the washer before cleaning** to avoid the risk of electric shock.
- **Never use harsh chemicals, abrasive cleaners, or solvents to clean the washer.** They will damage the finish.
- **Do not put oily or greasy rags or clothing on top of the washer.** These substances give off vapors that could ignite the materials.
- **Do not wash items that are soiled with vegetable or cooking oil.** These items may contain some oil after laundering. Due to the remaining oil, the fabric may smoke or catch fire by itself.
- **Disconnect this appliance from the power supply before attempting any user maintenance.** Turning the controls to the **OFF** position does not disconnect this appliance from the power supply. Failure to follow this warning can cause serious injury, fire, electrical shock, or death.
- **Do not combine laundry products for use in one load unless specified on the label.**
- **Do not mix chlorine bleach with ammonia or acids such as vinegar. Follow package directions when using laundry products.** Incorrect usage can produce poisonous gas, resulting in serious injury or death.
- **Do not reach into the washer while parts are moving. Before loading, unloading or adding items, press the START/PAUSE button and allow the drum to coast to a complete stop before reaching inside.** Failure to follow this warning can cause serious injury, fire, electrical shock, or death.
- **Do not allow children to play on or in the washer. Close supervision of children is necessary when the washer is used near children. As children grow, teach them the proper, safe use of all appliances.** Failure to comply with these warnings could result in serious personal injuries or death.
- **Destroy the carton, plastic bag and other packing materials after the washer is unpacked. Children might use them for play. Cartons covered with rugs, bedspreads, or plastic sheets can become airtight chambers.** Failure to comply with these warnings could result in serious personal injuries or death.
- **Keep laundry products out of reach of children. To prevent personal injury, observe all warnings on product labels.** Failure to comply with these warnings could result in serious personal injuries.
- **Remove the lid to the washing compartment before your washer is removed from service or discarded to avoid the danger of children or small animals getting trapped inside.** Failure to do so can result in serious personal injury or death.
- **Keep hands and foreign objects clear of the lid and latch area when closing the lid. Failure to keep hands clear can result in personal injury.**

SAVE THESE INSTRUCTIONS

PARTS AND FEATURES

SPECIAL FEATURES

A SMARTRINSE™ WITH JET SPRAY

This washer is designed to save rinse water by using the SMARTRINSE™ with jet spray in COTTON/NORMAL and ECO COTTON cycles.

B INVERTER DIRECT DRIVE

Inverter Direct Drive eliminates the belt and pulleys found on most washers to provide improved performance and reliability while increasing energy efficiency.

C LID LOCK SWITCH

The washer lid is locked during operation. The lid can be unlocked by pressing the Start/Pause button to stop the washer.

D SLAMPROOF™ LID

The SLAMPROOF™ lid is a safety device that closes the lid slowly. The SLAMPROOF™ lid keeps the heavy lid from falling and injuring the user.

E WAVEFORCE™

Rapidly rotating drum uses centrifugal force and an angled spray to pull water through the fabric, resulting in less friction for a gentler and more thorough cleaning.

F SMARTDIAGNOSIS™

Should you experience any technical difficulty with your washing machine, it has the capability of transmitting data by phone to the Customer Information Center. The call center agent records the data transmitted from your machine and uses it to analyze the issue, providing a fast and effective diagnosis (refer to page 31).

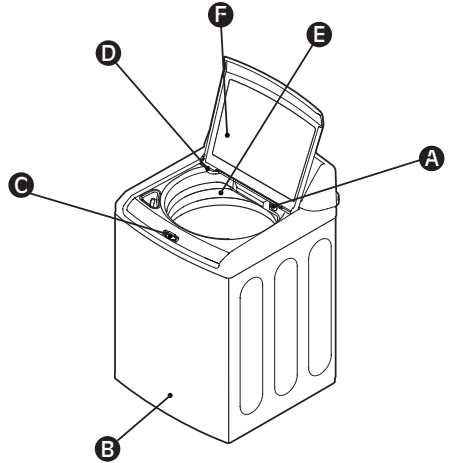

PARTS AND FEATURES

KEY PARTS AND COMPONENTS

In addition to the special features and components outlined in the **Special Features** section, there are several other important components that are referenced in this manual.

- A ULTRA-CAPACITY STAINLESS STEEL DRUM**
The ultra-large stainless steel drum offers extreme durability.

- B ROTARY KNOB**
Turn this knob to select the desired cycle. Once the desired cycle has been selected, the standard presets will be shown in the display. These settings can be adjusted using the cycle setting buttons anytime before starting the cycle.

- C ADJUSTABLE LEVELING FEET**
Use to level the washing machine for correct balance & spin operation.

- D REAR CONTROL PANEL WITH LED DISPLAY**
The easy-to-read LED display show cycle options, settings, processing, estimated time remaining during operation.

- E DETERGENT DISPENSER DRAWER**
There are two compartments, one each for main wash (liquid or powder) and liquid fabric softener.

- F LIQUID BLEACH DISPENSER**
The bleach dispenser automatically dilutes and dispenses liquid bleach at the proper time in the wash cycle.

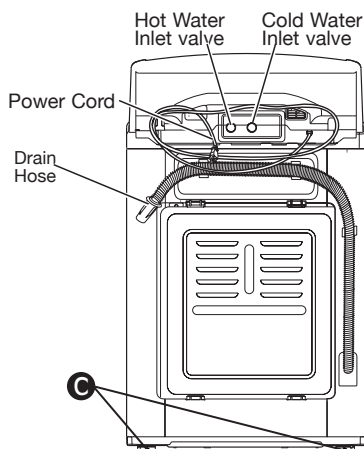
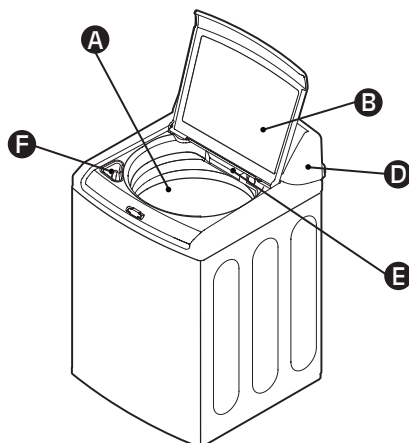

Included Accessories

- Water supply hoses (1 Each for COLD and HOT water)

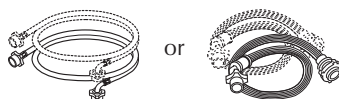

- Tie Strap (for securing drain hose)



INSTALLATION INSTRUCTIONS

CHOOSE THE PROPER LOCATION

⚠ WARNING

- **The washer is heavy! Two or more people are required when moving and unpacking the washer.** Failure to do so can result in back or other injury.
- **Store and install the washer where it will not be exposed to temperatures below freezing or exposed to outdoor weather conditions.** Failure to follow this warning can cause serious injury, fire, electrical shock, or death.
- **Properly ground washer to conform with all governing codes and ordinances.** Failure to follow this warning can cause serious injury, fire, electrical shock, or death.
- **To reduce the risk of electric shock, do not install the washer in humid spaces.** Failure to follow this warning can cause serious injury, fire, electrical shock, or death.
- The base opening must not be obstructed by carpeting when the washer is installed on a carpeted floor.
- Keep the area underneath and around your appliances free of combustible materials such as lint, paper, rags, chemicals, etc.
- **Do not remove ground prong. Do not use an adapter or extension cord. Plug into a grounded 3-prong outlet.** Failure to follow this warning can cause serious injury, fire, electrical shock, or death.

POWER OUTLET

- The power outlet must be within 1.5 m of either side of the washer.
- The appliance and outlet must be positioned so that the plug is easily accessible.
- Do not overload the outlet with more than one appliance.
- The outlet must be grounded in accordance with current wiring codes and regulations.
- Time-delay fuse or circuit breaker is recommended.

NOTE: It is the personal responsibility and obligation of the product owner to have a proper outlet installed by a qualified electrician.

FLOORING

- To minimize noise and vibration, the washer **MUST** be installed on a solidly constructed floor.
- Allowable slope under the entire washer is 1° maximum.
- Carpeting and soft tile surfaces are not recommended.
- Never install the washer on a platform or weakly supported structure.

NOTE: The washer must be installed on firm flooring to minimize vibration during the spin cycle. Concrete flooring is best, but a wood floor is sufficient, provided it is built to FHA standards. The washer should not be installed on rugs or exposed to weather.

CLEARANCES

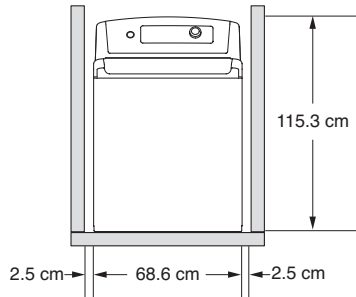

To ensure sufficient clearance for water lines allow minimum clearances of at least 1 inches (2.5 cm) at the sides and 4 inches (10 cm) behind the unit. Be sure to allow for wall, lid, or floor moldings that may increase the required clearances.

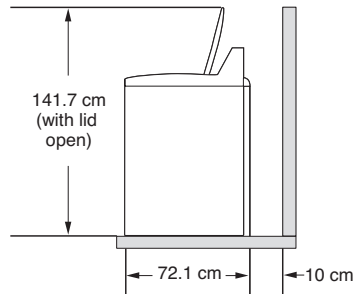

Minimum vertical space from floor to overhead shelves, cabinets, ceilings, etc., is 142cm.

INSTALLATION INSTRUCTIONS

UNPACK THE WASHER

- 1 After the washer is in the home, remove the carton and Styrofoam® shipping base from the washer.

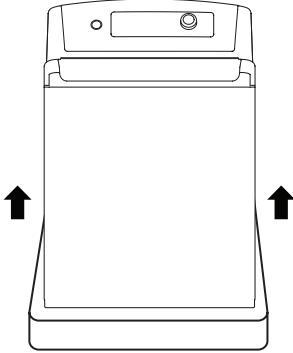

When removing the washer from the carton base, be sure to remove the tub support in the middle of the carton base. If you must lay the washer down to remove the base packaging materials, always protect the side of the washer and lay it carefully on its side. Do NOT lay the washer on its front or back.

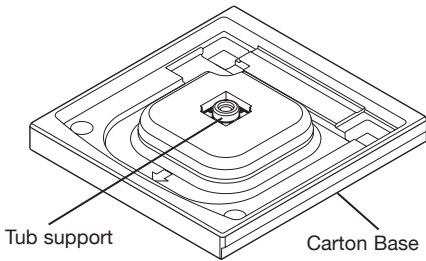

- 2 Remove the packing block containing the owner's manual, parts, water hoses, and laundry product samples.

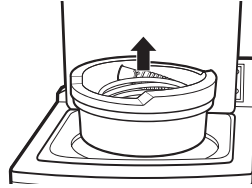

- 3 Unfasten the power cord from the back of the washer.

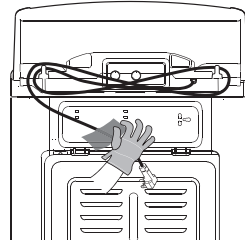

TOOLS YOU WILL NEED

- Adjustable Pliers

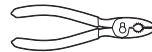

- Carpenter's Level



INSTALLATION INSTRUCTIONS

CONNECTING THE WATER LINES

- **IMPORTANT:** Use new hoses when installing the washer. Do NOT reuse old hoses.
- **IMPORTANT:** Use ONLY the inlet hoses provided by LG with this laundry product. Aftermarket hoses are not guaranteed to fit or function correctly. Other hoses may not tighten correctly and could cause leaks. Subsequent damage to product or property will not be covered under the terms of LG's warranty.
- Water supply pressure must be between 30-800 kPa. If the water supply pressure is more than 800 kPa, a pressure reducing valve must be installed.
- Periodically check the hose for cracks, leaks, and wear, and replace the hose every 5 years.
- Make sure that the water lines are not stretched, pinched, crushed, or kinked.
- The washer should never be installed or stored in a location subject to freezing temperatures. Damage to the water lines and internal mechanisms of the washer can result. If the washer was exposed to freezing temperatures prior to installation, allow it to stand at room temperature for several hours before use.

- 1 Inspect the threaded fitting on each hose and make sure there is a rubber seal in place in both ends.

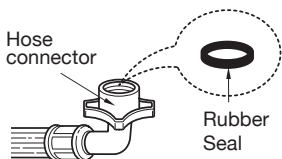

- 2 Connect water hose to hose utilities. Connect the water hoses to the HOT and COLD water valves of your home. Hand tighten, plus make an additional 1/4 turn with pliers.

NOTE: A water heater set to deliver 120°F (49°C) water to the washer.

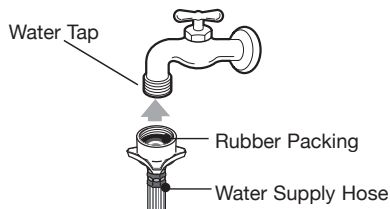

NOTE: To avoid build up that can clog the inlet valve screen, thoroughly flush both faucet and hose to remove any particles or other impurities by running water through them into a container.

- 3 Attach water hose to washer. Thread the hot water hose onto the washer hot water connection (red) and the cold water hose onto the cold water connection (blue). Hand tighten; then make an additional 1/8 turn with pliers.

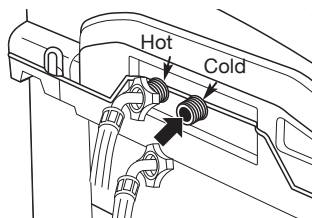

NOTE: Do not cross-thread the hose fittings. Attach the hot water line to the red hot water inlet on the back of the washer. Attach the cold water line to the blue cold water inlet on the back of the washer. Tighten the fittings securely.

NOTE: Tighten the fittings securely. Open the water taps fully to check for leaks.

CONNECTING THE DRAIN LINE

- The drain hose should always be properly secured. Failure to properly secure the drain hose can result in flooding and property damage.
- Do not install the end of the drain hose higher than 243.8 cm above the bottom of the washer.
- The drain must be installed in accordance with any applicable local codes and regulations.
- Make sure that the water lines are not stretched, pinched, crushed, or kinked.

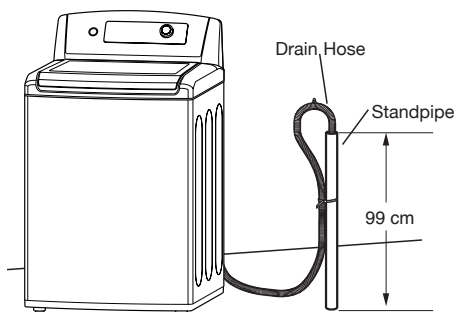

INSTALLATION INSTRUCTIONS

CONNECTING THE DRAIN LINE (cont.)

Firmly insert the free end of the drain hose into the drain opening of your home. Make sure the soft rubber end is completely inside the drain opening.

- If the water valves and drain are built into the wall, fasten the drain hose to one of the water hoses with the cable tie (ribbed side on inside).
- If your drain is a standpipe, fasten the drain hose to the standpipe with the cable tie provided.

NOTE:

- Total height of the hose end should be approximately 0.9 ~ 1.2 m from the floor.
- The drain hose should be inserted no more than 20-30 centimeters into the standpipe.

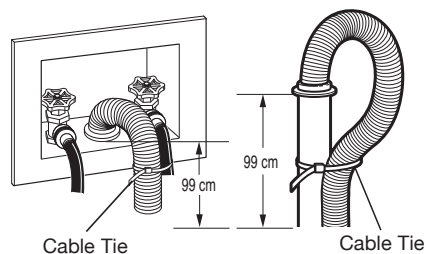

LEVELING THE WASHER

The washer spins at very high speeds.

NOTE: Adjust the leveling feet only as far as necessary to level the washer. Extending the leveling feet more than necessary can cause the washer to vibrate.

- All four leveling feet must rest solidly on the floor. Rock the washer gently from corner to corner to make sure that the washer does not rock.

NOTE: Before installing the washer, make sure the floor is clean, dry and free of dust, dirt, water and oils so the washer feet can not slide easily. Leveling feet that can move or slide on the floor can contribute to excess vibration and noise due to poor contact with the floor.

- 1 Position the washer in the final location, taking special care to not pinch, strain, or crush the water and drain lines. Place a level across the top of the washer.

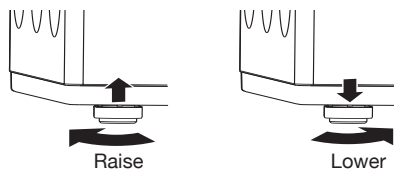

- 2 Adjust the leveling feet. Turn clockwise to raise the washer or counterclockwise to lower it.

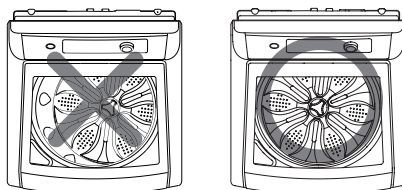

- 3 To make sure that the washer is properly level, open the lid and look from above to see if it is same as shown above. If you have a level, check your washer with the level.
 - To check if the washer is level side to side, close the lid and place a level at the back of the lid.
 - To check if the washer is level front to back, place a level at the side of the washer on the edge where the cabinet side meets the top cover.

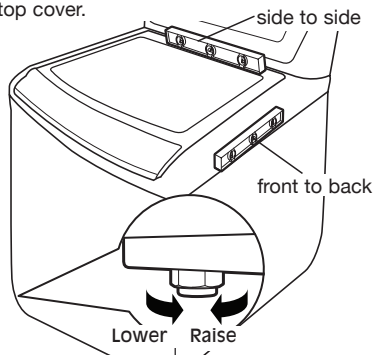

If the washer is not level, adjust the leveling feet. Turn clockwise to raise, counterclockwise to lower.

CONNECT TO THE POWER SUPPLY

The washer should be plugged into a 220-240V AC, 50Hz grounded 3-prong outlet. Plug in the washer.

CONTROL PANEL FEATURES

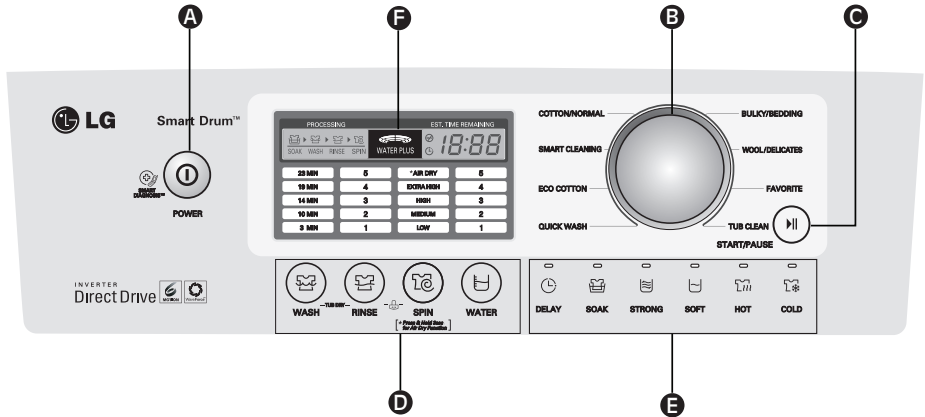

A POWER ON/OFF BUTTON

Press to turn the washer ON. Press again to turn the washer OFF.

B CYCLE SELECTOR KNOB

Turn this knob to select the desired cycle. Once the desired cycle has been selected, the standard presets will be shown in the display. These settings can be adjusted using the cycle setting buttons before starting the cycle.

C START/PAUSE BUTTON

Press this button to START the selected cycle. If the washer is running, use this button to PAUSE the cycle without losing the current settings.

NOTE: If you do not press the START/PAUSE button within 4 minutes of selecting a cycle, the washer automatically turns off.

NOTE: If the washer remains idle for 8 minutes after pausing the cycle, the water in the tub will drain.

D CYCLE MODIFIER BUTTONS

Use these buttons to select the desired cycle options for the selected cycle. Press the button for that setting until the indicator light for the desired value is lit.

E OPTION BUTTONS

The option buttons allow you to select additional cycle options and will light when selected. Certain buttons also allow you to activate special functions by pressing and holding the button for 3 seconds.

For detailed information about the individual options, please see the following pages.

F LED DISPLAY

The display shows the settings, estimated time remaining, options, and status messages for your washer. The display will remain on through the cycle.

HOW TO USE

OPERATING THE WASHER

⚠WARNING: To reduce the risk of fire, electric shock, or personal injury when using this appliance, follow basic precautions, including the following.

Once you have loaded the washer and added laundry products (detergent, bleach, and/or fabric softener):

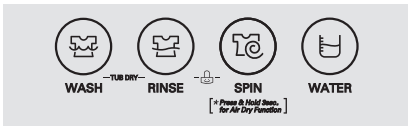
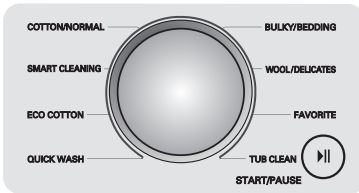
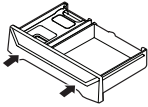

START/PAUSE

- 1 SORT LAUNDRY AND LOAD WASHER.**
Refer to page 16.
- 2 ADD DETERGENT.**
Refer to pages 17-18.
- 3 TURN ON THE WASHER.**
Press the POWER button to turn on the washer. The lights around the cycle selector knob will illuminate.
- 4 SELECT CYCLE.**
Turn the cycle selector knob to the desired cycle. The display will show the preset WASH, RINSE, SPIN, WATER for that cycle.
- 5 SELECT CYCLE MODIFIER BUTTONS.**
If you would like to change the modifier for that cycle, press the appropriate cycle settings button(s) until the indicator light for the desired setting is lit.
NOTE: To protect your garments, not every WASH, RINSE, SPIN, WATER, or OPTION is available with every cycle.
- 6 SELECT OPTION BUTTONS.**
Select any additional cycle options, such as FABRIC SOFTENER or DELAY WASH.
NOTE: To protect your garments, not every WASH, RINSE, SPIN, WATER, or OPTION is available with every cycle.

- 7 BEGIN CYCLE.**
Press the START/PAUSE button to begin the cycle. The lid will latch, the display will change, and the washer will calculate the estimated time remaining. Once the washer has calculated the estimated total cycle time, the washer will start. To pause the cycle at any time, press PAUSE. To resume the cycle press START/PAUSE again.

NOTE: When the wash cycle is finished, the beeper (if set) will sound and the lid will unlock. To prevent wrinkling, remove items from the washer immediately after the end of the cycle.

HOW TO USE

CYCLE GUIDE

The cycle guide below shows the options and recommended fabric types for each cycle. ■=Default setting

Cycle	Fabric Type	Wash	Rinse	Spin	Water Level	Delay	Soak	Strong	Soft	Hot	Cold
COTTON/ NORMAL	Cotton, linen, towels, shirts, sheets, jeans, mixed loads	23	5	AIR DRY	5						
		19	4	EXTRA HIGH	4						
		14	3	HIGH	3	●	●	●	●	●	■
		10	2	MEDIUM	2						
		3	1	LOW	1						
SMART CLEANING	Heavily soiled underwear, work clothes, diapers, etc.	23	5	EXTRA HIGH	5						
		19	4	HIGH	4						
		14	3	MEDIUM	3	●	●	●	●	■	■
		10	2	LOW	2						
		3	1		1						
ECO COTTON	Normally soiled load	23	5	EXTRA HIGH	5						
		19	4	HIGH	4						
		14	3	MEDIUM	3	●	●	●	●	●	■
		10	2	LOW	2						
		3	1		1						
QUICK WASH	Lightly soiled and colored clothing	23	5	MEDIUM	2						
		19	4	LOW	1						
		14	3			●		●	●	●	■
		10	2								
		3	1								
BULKY/ BEDDING	Large Items such as blankets and comforters.	23	5	EXTRA HIGH	5						
		19	4	HIGH	4						
		14	3	MEDIUM	3	●	●	■	●	●	■
		10	2	LOW	2						
		3	1		1						
*Use the Bulky/Bedding cycle for items such as pillows, comforters and other articles which have difficulty absorbing water. ONLY WASH SMALL LOADS to make sure there is plenty of room for the load to move during washing. Keep like items together; do not mix large bulky items with smaller clothing items. Failure to follow these instructions may result in damage to the clothing or to the washer.											
WOOL/ DELICATES	Item labeled machine washable wool Dress shirts/blouses nylons, sheer or lacy garments	23	5	LOW	5						
		19	4		4						
		14	3		3						
		10	2		2						■
		3	1		1						
FAVORITE	Your preferred garments	23	5	EXTRA HIGH	5						
		19	4	HIGH	4						
		14	3	MEDIUM	3	●	●	●	●	●	■
		10	2	LOW	2						
		3	1		1						
TUB CLEAN	Refer to page 23.				5		■				■

NOTE: To protect your garments, not every WASH, RINSE, SPIN, WATER, or OPTION is available with every cycle.

HOW TO USE

INFORMATION FOR ENERGY TEST

- Water Temperature: Select water temperature to suit wash cycles. Always follow garment manufacturer's care label or instructions when washing.
- Set program at "Eco cotton, Soak 1:20, Hot wash, Wash 23 min, Water level 4, Rinse 3, Spin Extra high" is for normally soiled load and test in accordance or in conformity with AS/NZS 2040. 1.
- The test results depend on water pressure, water hardness, water inlet temperature, room temperature, type and amount of load, degree of soiling utilized detergent, fluctuations in the main electricity supply and chosen additional options.
- For best washing results, we recommend to mix dry detergent with HOT & COLD water.

NOTE: The bleach dispenser does not dispense during the ENERGY TEST program.

NOTE: During the 'ENERGY TEST program', changing the current setting is not allowed even with a pause.

SORTING WASH LOADS

CAUTION Do not load items over the tub. Failure to follow this caution can result in leakage or fabrics damage. Use the **BULKY/BEDDING** cycle for buoyant or nonabsorbent items such as pillow or comforter. Failure to follow this caution can result in leakage.

CAUTION Do not wash or spin any item labeled or known to be Water-proof or water-resistant, even if the product care Label on the item permits machine washing. Failure to follow these instructions could result in severe damage to your laundry, your washer and/or property damage as a result of abnormal vibration of the washer.

- Examples of water-proof or water-resistant items include certain mattress pads, mattress covers, Rain gear, camping gear, skiing apparel, outdoor gear and similar items.

Fabric Care Labels

Most articles of clothing feature fabric care labels that include instructions for proper care.

Fabric Care Labels

Machine wash cycle			
	Normal	Permanent press/ wrinkle resistant	Gentle/ delicate
Hand wash			
	Hand wash	Do not wash	Do not wring
Water temperature			
	Hot	Warm	Cold/cool
Bleach symbols			
	Any bleach (when needed)	Only non-chlorine bleach (when needed)	Do not bleach

Grouping Similar Items

For best results, sort clothes into loads that can be washed with the same wash cycle.

Different fabrics have different care requirements.

Always wash dark colors separately from light colors and whites to prevent discoloration. If possible, do not wash heavily soiled items with lightly soiled ones. The chart below shows recommended groupings.

Sort Laundry...

by Colors	by Soil	by Fabric	by Lint
Whites	Heavy	Delicates	Lint Producer
Lights	Normal	Easy Care	Lint Collector
Darks	Light	Sturdy	

Loading the Washer



Bulky items should be placed as far down in the wash basket as possible for optimal results. Always place buoyant items at the bottom of the wash basket.

The washer will automatically detect the load size. Because of the high-efficiency wash system, the water level may not completely cover the load.

• Check all pockets to make sure that they are empty. Items such as clips, matches, pens, coins, and keys can damage both your washer and your clothes.

• Close zippers, hooks, and drawstrings to prevent these items from snagging or tangling on other clothes.

• Pretreat heavily stained areas for best results.

• Large items should not be more than half of the total wash load.

• Do not wash fabrics containing flammable materials (waxes, cleaning fluids, etc.)

• The washer will not fill or operate with the lid open.

* **IMPORTANT:** Use the Bulky/Bedding cycle for large or bulky items such as poly-filled jackets, comforters, pillows, etc. These items may not be as absorbent as other laundry items and should be sorted into a separate wash load for optimal results.

ABOUT THE DISPENSER

The automatic dispenser consists of two compartments which hold:

- Liquid fabric softener.
- Powder detergent.

All laundry products can be added at once in their respective dispenser compartments. They will be dispensed at the appropriate time for the most effective cleaning. After adding the laundry products to the dispenser, close the dispenser drawer.

To add detergent, and fabric softener to the automatic dispenser:

- 1 Open the dispenser drawer.
- 2 Load the laundry products into the appropriate compartments.
- 3 Close the drawer slowly and smoothly to avoid spilling, splashing or premature dispensing of the contents.

NOTE: It is normal for a small amount of water to remain in the dispenser compartments at the end of the cycle.

NOTE: Do not use bleach in the dispenser drawer.

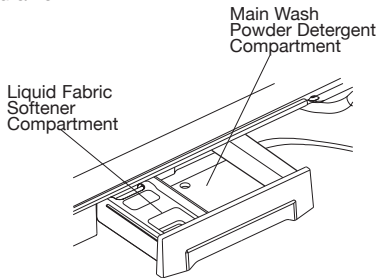

Removing the dispenser drawer

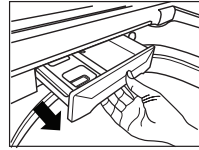

- 1 Pull the dispenser drawer.

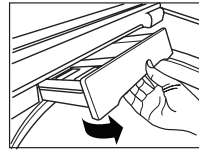

- 2 Tilt the dispenser drawer upward and remove it.

Replacing the dispenser drawer

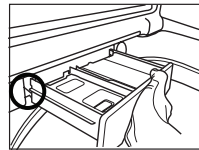

- 1 Place rail 2 (dispenser drawer rail) on top of rail 1.

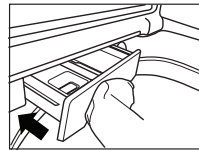
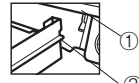

- 2 Push the dispenser drawer firmly.

NOTE: Be careful not to pinch your finger.

HOW TO USE

LOADING THE DISPENSER

Using the Liquid Bleach Dispenser

The bleach dispenser automatically dilutes and dispenses liquid chlorine bleach at the proper time in the wash cycle.

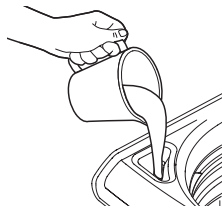

- 1 Check clothing care labels for special instructions.
- 2 Measure liquid bleach carefully, following instructions on the bottle.
 - Never pour undiluted liquid chlorine bleach directly onto clothes or into the wash basket.
 - Do not pour powdered bleach into bleach dispenser. Do not place load items on top of the bleach dispenser when loading and unloading the washer.
 - Avoid overfilling or splashing when adding bleach to the dispenser. The maximum capacity of the bleach dispenser is one cup of bleach per wash cycle. Overfilling could result in premature dispensing of bleach.
- 3 Before starting the washer, pour a pre-measured amount of bleach directly into bleach dispenser. If you prefer to use powdered bleach, add it into the wash basket directly before adding clothes.

NOTE: Please flush the bleach dispenser with water after bleach use and then rinse out the residue by use of Rinse & Spin cycle.

⚠WARNING: Do NOT mix chlorine bleach with ammonia or acids, such as vinegar or rust / scale remover. Mixing chemicals like these can produce gas which may cause death. Put the manufacturer's recommended amount of undiluted liquid chlorine bleach into the bleach dispenser. During the final portion of the wash cycle, two sequential flushes of the dispenser put all the bleach into the wash load and completely flush the dispenser to eliminate the carryover of bleach to a subsequent load. Any liquid remaining in the bleach dispenser at the end of the cycle is water, not bleach.

To prevent unintentional self-siphoning of the bleach, never fill the dispenser higher than the maximum fill level marked on the dispenser.

When adding bleach to the dispenser, be careful to avoid spilling it into the laundry load or leaving droplets of bleach around the dispenser. These things will damage your laundry items.

Main Wash Detergent Compartment

This compartment holds laundry detergent for the main wash cycle, which is added to the load at the beginning of the cycle. Never exceed the detergent manufacturer's recommendations when adding detergent. Using too much detergent can result in detergent buildup in clothing and the washer. Follow the recommendations of the Detergent manufacturer.

* Except ENERGY TEST course

Water Level	Water Q'ty (l)	Detergent Softener etc.
5	125	Please use amount of each manufacturer's recommended dosage.
4	100	
3	70	
2	45	
1	35	

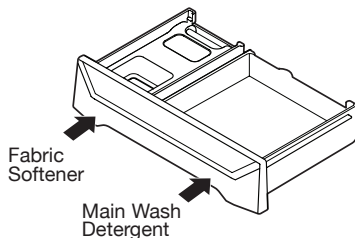

Fabric Softener Compartment

This compartment holds liquid fabric softener, which will be automatically dispensed during the final rinse cycle.

- Always follow the detergent manufacturer's recommendations when adding fabric softener. Do not exceed the maximum fill line. Using too much fabric softener may result in stained clothes.
- Dilute concentrated fabric softeners with warm water. Do not exceed the maximum fill line.
- Never pour fabric softener directly onto the load or into the drum.

THE LED DISPLAY

The LED display shows the settings, estimated time remaining, options, and status messages for your washer. When the washer is turned on, the display will illuminate.

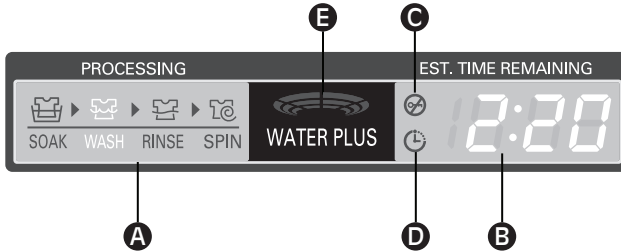

A CYCLE STATUS INDICATOR

This portion of the display shows which stage of the wash cycle is currently underway SOAK, WASH, RINSE, or SPIN.

B ESTIMATED TIME REMAINING

When the START/PAUSE button is pressed, the washer automatically detects the wash load (weight) and optimizes the washing time based on the selected cycle and options. The display will then indicate the estimated time remaining for the selected wash cycle.

C LID LOCK INDICATOR

Indicates that the lid is locked. The washer lid will lock while the washer is operating. The lid can be unlocked by pressing the START/PAUSE button to stop the washer.

D DELAY WASH INDICATOR

This indicator shows that the washer has been set for DELAY WASH. The washer will start automatically after the set delay time has passed.

E Water Plus

When you want to remove effective detergent, you use Water Plus.

- It only operates in Cotton/Normal, Smart Cleaning, Favorite Program.
- Each time you press the rinse button, the content will change as follows:

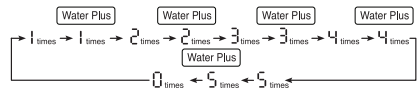

HOW TO USE

CYCLE MODIFIER BUTTONS

Each cycle has preset settings that are selected automatically. You may also customize the settings using the cycle setting buttons.

Press the button for that setting until the indicator light for the desired value is lit.

The washer automatically adjusts the water level for the type and size of wash load for best results and maximum efficiency. It may seem there is no water inside the tub in some cycles, but this is normal.

NOTE: To protect your garments, not every wash/rinse temperature, spin speed, soil level, or option is available with every cycle. A beeper will sound and the LED will not light if a selection is not allowed. See the Cycle Guide on page 15 for details.

WASH



WASH



Adjust to select the proper time for the wash cycle.

- Adjust to select the proper time for the wash cycle.
- The bleach dispenser does not dispense during the wash cycle when select 3 MIN.

RINSE



RINSE



Adjust to select the proper times for the rinse cycle.

- If adjustments are needed during the rinse, press the [start/pause] button before making any changes.
- When you want to remove effective detergent, you use Water Plus.

SPIN



SPIN



The washer spins at very high speeds. This reduces drying time and saves energy. Press the SPIN button until the indicator light for the desired setting is lit.

WATER LEVEL



WATER



- This machine detects the quantity of laundry automatically, then sets the WATER LEVEL and proper amount of Detergent.
- When you select a wash program, the WATER LEVEL and amount of Detergent (to be used) will be shown on the control panel.
- The following table shows the amount of water. (refer to page 18)
- When the WATER LEVEL is automatically detected, it may differ depending on the quantity of laundry even though the same WATER LEVEL is indicated on the control panel.

CYCLE OPTION BUTTONS

Your washing machine features several additional cycle options to customize cycles to meet your individual needs. Certain option buttons also feature a special function that can be activated by pressing.

NOTE: To protect your garments, not every wash, rinse, spin, water, or option is available with every cycle. See the Cycle Guide for details.

SOAK



SOAK

Allows the consumer to remove stains more thoroughly by specifying additional time for the clothing to soak during washing. At the end of SOAK, the wash

cycle will be started without drain.

- It is possible to select soaking time 40 minutes, 60 minutes, or 80 minutes by pressing the SOAK button repeatedly.
- It is normal that washer do weak agitation during SOAK cycle.

STRONG & SOFT



STRONG

SOFT

• During washing, when you want to adjust the water power, use these buttons.

- Initially, since normal water power, it will not be displayed.
- It is possible to select STRONG & SOFT. But, the choice is not simultaneous. Each time you press the button, On/Off is repeated.

HOT & COLD



HOT



COLD

- When you select HOT & COLD, Use these buttons.
- Basically, COLD is selected.
- If you wish to add HOT, you press the HOT button. At the same time, HOT & COLD LED light.
- Just to select HOT, COLD is off by pressing COLD button.
- While operating, you can change it.
- In the WOOL/DELICATE & TUB CLEAN course, Just COLD will be selected. (If HOT is used, Laundry may be damaged.)
- In the SMART CLEANING course, HOT & COLD will be selected at the same time.

DELAY WASH



DELAY

Once you have selected the cycle and other settings, press this button to delay the start of the wash cycle. Each press of the button increase the delay time, up to 3-18 hours.

HOW TO USE

CYCLE OPTION BUTTONS (cont.)

TUB DRY



When you press the Wash and Rinse button simultaneously, the Tub Dry course will be set or canceled.

- When you select the Tub Dry, do not put any laundry in the drum.
- When Tub Dry is selected, other buttons will be inactive.

NOTE: When you select Tub Dry

- 1) Use this function to minimize the growth of mold from the residual moisture within the laundry.
- 2) When you select the Tub Dry course, do not put any laundry or detergent in the drum.
- 3) It is good to use this about once a week.

AIR DRY



[* Press & Hold 3 Sec. for Air Dry Function]

- Press & hold 3 seconds SPIN button for AIR DRY function.
- When you want to reduce dry time of laundry, Use it.
- Once AIR DRY is selected, the other button's function is not selected.
- When you want to AIR DRY turn off, please press POWER button.

NOTE: When you select Air dry for more than 60 minutes

- 1) You can reduce the drying time by minimizing the moisture in the laundry.
- 2) Always keep the laundry amount to 2kg or less and make sure to spread it out evenly.
- 3) Select 60 minutes for cotton laundry and 120 minutes for synthetic fiber laundry for effective Moisture removal.

CHILD LOCK

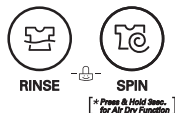

- Use to lock or unlock the control buttons to prevent settings from being changed by a child. To lock, push the RINSE and SPIN buttons simultaneously and to unlock push them one more time during the washing process.

- During the wash program, all the buttons are locked until washing is completed or the child-lockfunction is deactivated manually.
- The child lock function cannot be activated in standby mode. The child lock function can ONLY be activated once a wash program has started.



<CHILD LOCK LED TURN OFF> <CHILD LOCK LED TURN ON>

REGULAR CLEANING

⚠️ WARNING:

- **Unplug the washer before cleaning to avoid the risk of electric shock.** Failure to follow this warning can cause serious injury, fire, electrical shock, or death.
- **Never use harsh chemicals, abrasive cleaners, or solvents to clean the washer.** They will damage the finish.

Cleaning the Exterior

Proper care of your washer can extend its life. The outside of the machine can be cleaned with warm water and a mild, nonabrasive household detergent.

Immediately wipe off any spills with a soft, damp cloth.

IMPORTANT: Do not use methylated spirits, solvents, or similar products.

Never use steel wool or abrasive cleansers; they can damage the surface.

Care and Cleaning of the Interior

Use a towel or soft cloth to wipe around the washer lid opening, and lid glass.

Always remove items from the washer as soon as the cycle is completed. Leaving damp items in the washer can cause wrinkling, color transfer, and odor.

This washer has a special cycle, TUB CLEAN, to remove inside buildup of detergent residue which can occur in the wash tub or drum and lead to mildew or musty smell.

Run the TUB CLEAN cycle monthly to remove detergent buildup and other residue.

Read these instructions carefully before beginning the TUB CLEAN cycle.

- ➊ Open the lid and remove any clothing in the wash drum.
- ➋ Open the dispenser drawer.
- ➌ Add liquid chlorine bleach or tub cleaner. Some powdered or tablet tub cleaners which are manufactured for this purpose can be used.
(NOTE: Do not add any laundry detergent or fabric softener to the drawer when using TUB CLEAN.)
- If using tablet cleaner
Add tablet cleaner to the wash drum directly.
(NOTE: Do not add tablet cleaner to the drawer.)
- ➍ Close the drawer and washer lid.
- ➎ Select TUB CLEAN and press START/PAUSE.

NOTE : It is recommended that TUB CLEAN should be repeated monthly.

If mildew or smell already exists, run TUB CLEAN for 3 consecutive weeks.

After TUB CLEAN is complete or when the washer is not used, leave the washer lid open for better ventilation and drying inside of the washer.

CARE AND CLEANING

REGULAR CLEANING (cont.)

Storing the Washer

If the washer will not be used for an extended period of time and is in an area that could be exposed to freezing temperatures:

- 1 Turn off water supply tap.
- 2 Disconnect hoses from water supply and drain water from hoses.
- 3 Plug the power cord into a properly grounded electrical outlet.
- 4 Add 3.8 L of nontoxic recreational vehicle (RV) antifreeze to the empty wash drum. Close the lid.
- 5 Select the spin cycle and let washer spin for 1 minute to drain out all the water.
NOTE: Not all of the RV antifreeze will be expelled.
- 6 Unplug the power cord, dry the drum interior with a soft cloth, and close the lid.
- 7 Remove the inserts from the dispenser. Drain any water in compartments and dry the compartments.
- 8 Store the washer in an upright position.
- 9 To remove the antifreeze from the washer after storage, run washer through a complete cycle using detergent. **Do not add laundry!**

Removing Lime Buildup

If you live in an area with hard water, lime scale can form on internal components of the washer. Use of a water softener is recommended in areas with hard water. If a descaler is used, make sure that it is suitable for use in a washer, and run the TUB CLEAN cycle before washing clothing.

Lime scale and other spots may be removed from the stainless steel drum using a stainless steel cleaner. Do NOT use steel wool or abrasive cleansers; they can damage the surface.

Leave the Lid Open

Leave the lid open after finishing laundry to keep the tub clean.

MAINTENANCE

Cleaning the Water Inlet Filters

If the washer detects that water is not entering the dispenser, an error message will show on the display. If you live in an area with hard water, this may be caused by clogged inlet filters.

IMPORTANT: Use extreme care when removing and cleaning the filters. If the filters cannot be cleaned or are damaged, do NOT operate the washer without the inlet filters. Contact LG Customer Service or a qualified LG servicer.

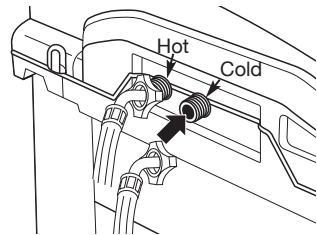

Turn off both water taps completely. Unscrew the hot and cold water lines from the back of the washer.

IMPORTANT: Use ONLY the inlet hoses provided by LG with this laundry product. Aftermarket hoses are not guaranteed to fit or function correctly. Other hoses may not tighten correctly and could cause leaks. Subsequent damage to product or property will not be covered under the terms of LG's warranty.

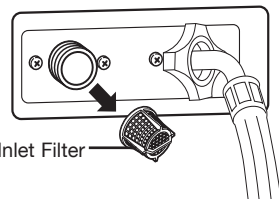

Carefully remove the filters from the water inlets, and soak them in white vinegar or a lime scale remover. Rinse thoroughly before reinstalling. Press the filters back into place and reattach the water lines. Do NOT operate the washer without the inlet filters.

CLEANING THE WASHER

Proper Use of Detergent

Using too much detergent is a common cause of laundry problems. Today's detergents are formulated to be effective without visible sudsing. Be sure to carefully read and follow manufacturer's recommendations for how much detergent to use in your wash.

You can use less detergent if you have soft water, a smaller load, or a lightly soiled load.

Care and Cleaning of the Washer

Lid: Wash with a damp cloth on the outside and inside and dry with a soft cloth.

Exterior: Immediately wipe off any spills. Wipe with damp cloth. Do not touch the surface or the display with sharp objects.

Moving and Storage: Ask the service technician to remove water from drain pump and hoses. Do not store the washer where it will be exposed to the weather.

Long Vacations: Be sure water supply is shut off at faucets. Drain all water from hoses if weather will be below freezing.

Dispenser Drawer: Detergent and fabric softener may build up in the dispenser drawer. Residue should be removed once or twice a month.

1 Remove the drawer by pulling it straight out until it stops. Lift up on the front of the drawer and pull it out.

2 Remove the insert; rinse the inserts and the drawer with warm water to remove traces of accumulated laundry products.

3 To clean the drawer opening, use a small, non-metal brush to clean the recess. Remove all residue from the upper and lower parts of the recess.

4 Return the inserts to the proper compartments and replace the drawer.

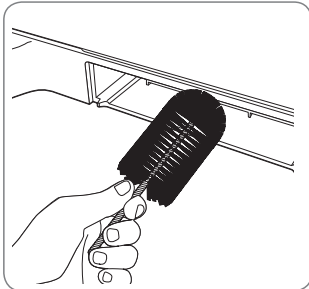
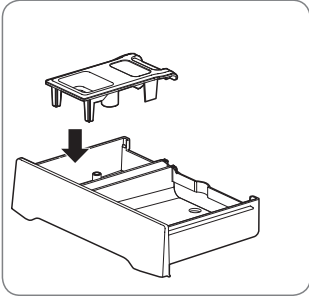
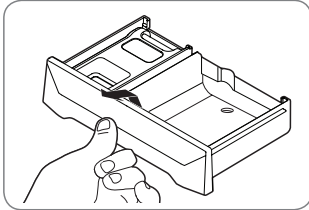
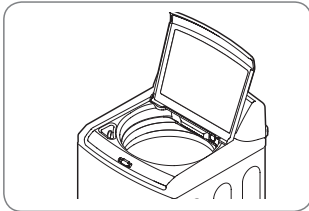

TROUBLESHOOTING

NORMAL SOUNDS YOU MAY HEAR

The following sounds may be heard while the washer is operating. They are normal.

Clicking:

- Lid lock relay when the lid locks and unlocks.
- The washer will make a series of clicking noises as it changes the cleaning mode.

High pitched noise:

The wash basket spins faster to remove moisture from the load.

Spraying or hissing:

Water spraying or circulating during the cycle.

Humming or gurgling:

Drain pump pumping water from the washer at the end of a cycle.

Water sloshing sound:

A liquid in the balance ring around the wash basket helps the basket spin smoothly.
(Washer is turned off and tub is rotated.)

Sound of water being added after the washer has already been operating:

- The washer adapts to the load size and type to add more water to the cycle as needed.
- The wash load may be unbalanced. If the washer senses that the load is unbalanced, it will stop and refill to redistribute the load.
- The washer may be diluting laundry additives to add to the wash load.



BEFORE CALLING FOR SERVICE

Your washing machine is equipped with an automatic error-monitoring system to detect and diagnose problems at an early stage. If your washer does not function properly or does not function at all, check the following before you call for service.

Problem	Possible Causes	Solutions
Rattling and clanking noise	<ul style="list-style-type: none">• Foreign objects, such as keys, coins, or safety pins, may be in drum or pump.	<ul style="list-style-type: none">• Stop washer and check drum for foreign objects. If noise continues after the washer is restarted, call for service.
Thumping sound	<ul style="list-style-type: none">• Heavy wash loads may produce a thumping sound.• Washer load may be out of balance.	<ul style="list-style-type: none">• This is normal. If sound continues, the washer is probably out of balance. Stop and redistribute the wash load.• Stop and redistribute the wash load.
Vibrating noise	<ul style="list-style-type: none">• Wash load may be unevenly distributed in the drum.• Not all leveling feet are resting firmly on the floor.• Floor not rigid enough.	<ul style="list-style-type: none">• Stop washer and rearrange the wash load.• Adjust the leveling feet. Make sure all four feet are in firm contact with the floor while the washer is in the spin cycle with a load.• Make sure that the floor is solid and does not flex. Refer to Flooring in the Installation section.
Water leaking around washer	<ul style="list-style-type: none">• Fill hose connection is loose at tap or washer.• House drain pipes are clogged.• Large items such as pillow and blanket over the tub.	<ul style="list-style-type: none">• Check hoses. Check and tighten hose connections.• Unclog drain pipe. Contact a plumber if necessary.• Check the cycle. If you wash large items, use BULKY/BEDDING cycle.• Stop washer and check the load position. Lay bulky items into the tub.
Excessive sudsing	<ul style="list-style-type: none">• Too much detergent or incorrect detergent.	<ul style="list-style-type: none">• Reduce detergent amount or use low-sudsing detergent.

TROUBLESHOOTING

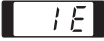
BEFORE CALLING FOR SERVICE (cont.)

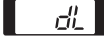
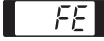
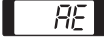
Problem	Possible Causes	Solutions
<p>Water in the washer drains slowly or not at all, or the display shows:</p> 	<ul style="list-style-type: none"> • Drain hose is bent, pinched, or clogged. 	<ul style="list-style-type: none"> • Make sure the drain hose is free of clogs, kinks, etc., and is not pinched behind or under the washer.
<p>Washer fills with water slowly or not at all, or the display shows:</p> 	<ul style="list-style-type: none"> • Water supply taps are not open fully. • Water line hoses are kinked, pinched, or bent. • Water inlet filters are clogged. • Water pressure to tap or house is too low. 	<ul style="list-style-type: none"> • Make sure that the water taps are open fully. • Make sure the hoses are not kinked or pinched. Be careful when moving the washer. • Clean the inlet filters. See the Care and Cleaning section. • Check another faucet in the house to make sure that household water pressure is adequate.
<p>Washer will not turn on</p>	<ul style="list-style-type: none"> • Power cord is not properly plugged in. • House fuse is blown, circuit breaker has tripped, or power outage has occurred. 	<ul style="list-style-type: none"> • Make sure that the plug is plugged securely into a grounded, 3-prong, 220-240 VAC, 50 Hz outlet. • Reset circuit breaker or replace fuse. Do not increase fuse capacity. If the problem is a circuit overload, have it corrected by a qualified electrician.
<p>The display shows:</p> 	<ul style="list-style-type: none"> • The lid is not closed properly. 	<ul style="list-style-type: none"> • Make sure that the lid is closed properly and press the START/PAUSE button. After starting a cycle, it may take a few moments before the drum begins to turn or spin. The washer will not spin unless the lid is locked (LID LOCK will appear in the display). • If the lid is closed and locked and the open lid error message is displayed, call for service. • If you press the START button while the lid is open, dE error message will be displayed.
<p>The display shows:</p> 	<ul style="list-style-type: none"> • Lid lock switch error 	<ul style="list-style-type: none"> • Make sure that the lid is closed properly and press the START/PAUSE button. The washer will not spin unless the lid is locked (LID LOCK will appear in the display). • If the lid is closed and the lid lock error message is displayed, call for service.
<p>Wash cycle time is longer than usual</p>	<ul style="list-style-type: none"> • The washer automatically adjusts the wash time for the amount of laundry, water pressure, water temperature, and other operating conditions. 	<ul style="list-style-type: none"> • This is normal. The washer adjusts cycle time automatically to provide optimal results for the selected cycle. • If you press the START button while the lid is open, dE error message will be displayed.
<p>The display shows:</p> 	<ul style="list-style-type: none"> • Water level is too high due to a faulty water valve. 	<ul style="list-style-type: none"> • Close the water taps, unplug the washer, and call for service.
<p>The display shows:</p> 	<ul style="list-style-type: none"> • Clutch error 	<ul style="list-style-type: none"> • Unplug the washer, and call for service.

TROUBLESHOOTING

BEFORE CALLING FOR SERVICE (cont.)

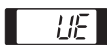
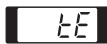
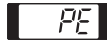
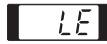
Problem	Possible Causes	Solutions
<p>The display shows:</p> 	<ul style="list-style-type: none"> • If the uE rebalance (see above) is not successful, this error will be displayed. • The load is too small. • Heavy articles are mixed with lighter items. • The load is out of balance. 	<ul style="list-style-type: none"> • The automatic attempt to rebalance the load was not successful. The cycle has been paused to allow the load to be manually adjusted. • Small loads may need additional items to be added to allow the washer to balance the loads. • The load may have heavy items loaded with lighter items. Always try to wash articles of somewhat similar weight to allow the washer to evenly distribute the weight of the load for spinning. • Manually redistribute the load if articles have become tangled preventing the automatic distribution from working properly.
<p>The display shows:</p> 	<ul style="list-style-type: none"> • Thermistor error 	<ul style="list-style-type: none"> • Unplug the washer and call for service.
<p>The display shows:</p> 	<ul style="list-style-type: none"> • The water level sensor is not working correctly. 	<ul style="list-style-type: none"> • Close the water taps, unplug the washer, and call for service.
<p>The display shows:</p> 	<ul style="list-style-type: none"> • Thermal overload protection circuit in the motor has been tripped. 	<ul style="list-style-type: none"> • Allow the washer to stand for 30 minutes to allow the motor to cool; then restart the cycle. If the LE error code still appears, unplug the washer and call for service.
<p>Staining</p>	<ul style="list-style-type: none"> • Add laundry products to the washer drum. • Washer not unloaded promptly. • Does not properly sort the clothes. 	<ul style="list-style-type: none"> • Load the laundry products into the dispenser. • Always remove items from the washer as soon as the cycle is completed. • Always wash dark colors separately from light colors and whites to prevent discoloration. If possible, do not wash heavily soiled items with lightly soiled ones.
<p>Wrinkling</p>	<ul style="list-style-type: none"> • Washer not unloaded promptly. • Washer overloaded. • Hot and cold water inlet hoses are reversed. 	<ul style="list-style-type: none"> • Always remove items from the washer as soon as the cycle is completed. • The washer can be fully loaded, but the drum should not be tightly packed with items. The lid of the washer should close easily. • Hot water rinse can set wrinkles in garments. Check the inlet hose connections.

TROUBLESHOOTING

BEFORE CALLING FOR SERVICE (cont.)

Problem	Possible Causes	Solutions
Washer won't operate	Control panel is asleep	<ul style="list-style-type: none"> This is normal. Press POWER.
	Washer is unplugged	<ul style="list-style-type: none"> Make sure cord is plugged securely into a working outlet.
	Water supply is turned off	<ul style="list-style-type: none"> Turn both hot and cold faucets fully on.
	Controls are not set properly	<ul style="list-style-type: none"> Make sure the cycle was set correctly, close the lid and press START.
	Lid is open-safety feature Prevents the washer from filling and operation when lid is up	<ul style="list-style-type: none"> Close lid and reset cycle, to the beginning if necessary.
	Circuit breaker/fuse is tripped/blown	<ul style="list-style-type: none"> Check house circuit breakers/fuses. Replace fuses or reset breaker. The washer should have a dedicated circuit.
	Electronics need to be reset	<ul style="list-style-type: none"> Press the POWER button.
	START was not pressed after a cycle was set	<ul style="list-style-type: none"> Press START.
	Extremely low water pressure	<ul style="list-style-type: none"> Check another faucet in the house to make sure that household water pressure is adequate.
	Washer is too cold	<ul style="list-style-type: none"> If the washer has been exposed to temperatures below freezing for an extended period of time, allow it to warm up before pressing POWER. Otherwise, the display will not come on.
Washer not filling properly	Filter clogged or fill hoses may be kinked	<ul style="list-style-type: none"> Make sure that filters (blue and orange screens must be free of solids) on the unit are not clogged. Turn off water and check filter by disconnecting hose at machine. Check that fill hoses are not kinked or clogged.
	Energy efficiency	<ul style="list-style-type: none"> This is an energy-efficient washer. As a result the temperature settings for this washer may be different than non-energy-efficient washers.
	Insufficient water supply	<ul style="list-style-type: none"> Make sure that the water supply is turned on. Make sure that the water faucets are turned to their completely open positions.
	The washer lid is open	<ul style="list-style-type: none"> The washer lid must be closed for all washer cycle operations. If the lid is opened during washer operation, all functions will stop, including water filling.
	Incorrect fill hose connection	<ul style="list-style-type: none"> Make sure that the fill hoses connect the hot water supply to the hot inlet on the washer, and the cold water supply to the cold inlet on the washer (hot to hot, cold to cold).
	Water fill optimization	<ul style="list-style-type: none"> Water may not cover the top level of the clothes. This is normal for this high-efficiency washer. The water fill is optimized by the system for best wash performance.

TROUBLESHOOTING

BEFORE CALLING FOR SERVICE (cont.)

Problem	Possible Causes	Solutions
Washer will not drain water	Kinked drain hose or drain located higher than 20.32cm above floor	<ul style="list-style-type: none"> Ensure that the drain hose is not kinked. Per the recommended installation instructions, the drain outlet cannot be over 20.32cm above the floor.
Water leaks every load	Hoses not installed correctly	<ul style="list-style-type: none"> Check all fill and drain hose connections to ensure that they are tight and secure.
Water leaks	Oversudsing of detergent	<ul style="list-style-type: none"> Oversudsing may create leaks, and may be caused by the type and amount of detergent used. Make sure that detergent and any additives are put into the correct dispenser compartments. Follow the detergent manufacturer's recommendations for the amount of detergent, but try using less detergent, especially if home water conditioning or water softening units are used.
Incomplete or no dispensing of detergent	Detergent compartments clogged from incorrect filling	<ul style="list-style-type: none"> Make sure that detergent and additives are put in to the correct dispenser compartments. For all detergent types, always make sure that the dispenser drawer is fully closed before the start of the cycle.
	Too much detergent use	<ul style="list-style-type: none"> Make sure that the suggested amount of detergent is used per the manufacturer's recommendations. You may also dilute the detergent with water to the maximum fill line on the compartment to avoid clogging.
	Insufficient water supply	<ul style="list-style-type: none"> Make sure that the water supply is turned on. Make sure that the water faucets are turned to their completely open positions.
	Normal residue	<ul style="list-style-type: none"> Normal operation. Residual may remain in the dispenser of the compartments. The dispenser box may be removed for occasional cleaning with warm water and a scrub brush.
Premature dispensing of bleach	Bleach dispenser filled for future load	<ul style="list-style-type: none"> You cannot store bleach in the dispenser for future use. The bleach dispenser will be dispensed every load for optimal safety of the washer.
	Overfilling the bleach dispenser	<ul style="list-style-type: none"> Overfilling the dispenser with bleach may lead to premature dispensing. There is a maximum fill line indicated on the bleach dispenser to help avoid overfilling.
Clogging of bleach	Bleach dispenser is not seated	<ul style="list-style-type: none"> Make sure that the bleach cover is properly seated and snapped into place before the start of the cycle.
	Insufficient cleaning	<ul style="list-style-type: none"> You may remove and clean the bleach cover with warm water and a scrub brush to clear clogging.
Poor stain removal	Presoak not selected	<ul style="list-style-type: none"> When stain inspector is used, presoak temperature and time are automatically selected. If you choose not to use the stain inspector, we recommend that you select presoak when defining your wash cycle. Always make sure that any additives are added to the pretreat dispenser bin before starting the cycle. Always refer to your clothes care label before treating stains.

USING SMARTDIAGNOSIS™

- Only use this feature when instructed to do so by the call center. The transmission sounds similar to a fax machine, and so has no meaning except to the call center.
- SmartDiagnosis™ cannot be activated if the washer does not power up. If this happens, then troubleshooting must be done without SmartDiagnosis™.

If you experience problems with your washer, call to Customer information center. Follow the call center agent's instructions, and do the following steps when requested:

- 1 Press the POWER button to turn on the washer. Do not press any other buttons or turn the cycle selector knob.
- 2 When instructed to do so by the call center, place the mouthpiece of your phone very close to the POWER button.

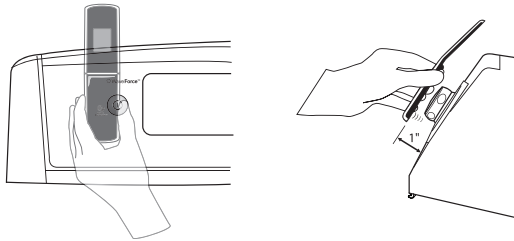

- 3 Press and hold the COLD button for three seconds, while holding the phone mouthpiece to the icon or POWER button.
- 4 Keep the phone in place until the tone transmission has finished. This takes about 6 seconds, and the display will count down the time.
 - For best results, do not move the phone while the tones are being transmitted.
 - If the call center agent is not able to get an accurate recording of the data, you may be asked to try again.
 - Pressing the POWER button during the transmission will shut off the SmartDiagnosis™.
- 5 Once the countdown is over and the tones have stopped, resume your conversation with the call center agent, who will then be able to assist you using the information transmitted for analysis at the call center.

“SmartDiagnosis is a troubleshooting feature designed to assist, not replace, the traditional method of troubleshooting through service calls. The effectiveness of this feature depends upon various factors, including, but not limited to, the reception of the cellular phone being used for transmission, any external noise that may be present during the transmission, and the acoustics of the room where the machine is located. Accordingly, LG does not guarantee that SmartDiagnosis would accurately troubleshoot any given issue.”

SPECIFICATION

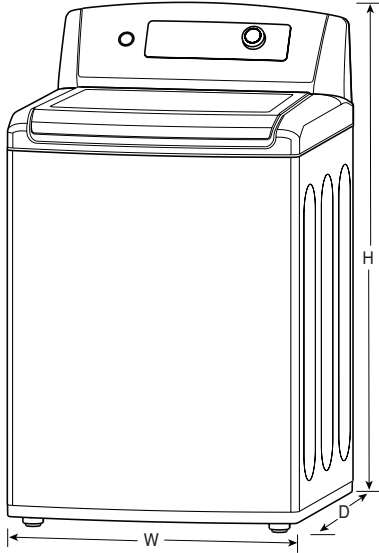

GUIDE FOR WASHING

Water Level	Amount of Laundry (kg)	Amount of Water (L)
5 lv	10.5 ~ 13.0	125
4 lv	7.8 ~ 10.5	110
3 lv	5.2 ~ 7.8	94
2 lv	2.6 ~ 5.2	69
1 lv	~2.6	43

Model	WT-R10686
Weight	66 kg
Size	686(W) x 721(D) x 1153(H)
Water tab pressure	30 -800 kPa (0.3 - 8.0 kgf/cm ²)

* In our continuing effort to improve the quality of our appliances, it may be necessary to make changes to the appliance without revising this manual.

MEMO

