



# OWNER'S MANUAL

# LED TV

\*LG LED TV applies LCD screen with LED backlights.

Please read this manual carefully before operating your set and retain it for future reference.

LN54\*\*  
LN565\*  
LA61\*\*

## TABLE OF CONTENTS

<b>3</b>	<b>SAFETY INSTRUCTIONS</b>	<b>35</b>	<b>OPEN SOURCE SOFTWARE NOTICE</b>
8	Viewing 3D Imaging (Only 3D models)	<b>35</b>	<b>EXTERNAL CONTROL DEVICE SETUP</b>
<b>9</b>	<b>INSTALLATION PROCEDURE</b>		
<b>9</b>	<b>ASSEMBLING AND PREPARING</b>		
9	Unpacking		
11	Separate purchase		
12	Parts and buttons		
13	Lifting and moving the TV		
14	Setting up the TV		
14	- Attaching the stand		
15	Mounting on a table		
17	Mounting on a wall		
18	Tidying cables		
<b>19</b>	<b>MAKING CONNECTIONS</b>		
19	Antenna connection		
20	HDMI connection		
20	Component connection		
21	Composite connection		
21	USB connection		
22	Headphone connection		
22	Audio Connection		
22	- Digital optical audio connection		
23	MHL connection		
<b>24</b>	<b>REMOTE CONTROL</b>		
<b>26</b>	<b>USING THE USER GUIDE</b>		
<b>27</b>	<b>MAINTENANCE</b>		
27	Cleaning your TV		
27	- Screen, frame, cabinet and stand		
27	- Power cord		
<b>27</b>	<b>TROUBLESHOOTING</b>		
<b>28</b>	<b>ENVIRONMENTAL INFORMATION</b>		
28	WEEE		
<b>29</b>	<b>SPECIFICATIONS</b>		
<b>35</b>	<b>LICENSES</b>		



### WARNING

- If you ignore the warning message, you may be seriously injured or there is a possibility of accident or death.



### CAUTION

- If you ignore the caution message, you may be slightly injured or the product may be damaged.



### NOTE

- The note helps you understand and use the product safely. Please read the note carefully before using the product.

# SAFETY INSTRUCTIONS

Please read these safety precautions carefully before using the product.

## WARNING



- Do not place the TV and remote control in the following environments:
    - A location exposed to direct sunlight
    - An area with high humidity such as a bathroom
    - Near any heat source such as stoves and other devices that produce heat
    - Near kitchen counters or humidifiers where they can easily be exposed to steam or oil
    - An area exposed to rain or wind
    - Near containers of water such as vases
- Otherwise, this may result in fire, electric shock, malfunction or product deformation.



- Do not place the product where it might be exposed to dust. This may cause a fire hazard.

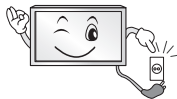

- Mains Plug is the TV connecting/ disconnecting device to AC mains electric supply. This plug must remain readily attached and operable when TV is in use.



- Do not touch the power plug with wet hands. Additionally, if the cord pin is wet or covered with dust, dry the power plug completely or wipe dust off. You may be electrocuted due to excess moisture.



- Make sure to connect Mains cable to compliant AC mains socket with Grounded earth pin. (Except for devices which are not grounded o earth.) Otherwise possibility you may be electrocuted or injured.



- Insert power cable plug completely into wall socket otherwise if not secured completely into socket, fire ignition may break out.



- Ensure the power cord does not come into contact with hot objects such as a heater. This may cause a fire or an electric shock hazard.



- Do not place a heavy object, or the product itself, on power cables. Otherwise, this may result in fire or electric shock.



- Bend antenna cable between inside and outside building to prevent rain from flowing in. This may cause water damaged inside the Product and could give an electric shock.



- When mounting TV onto wall make sure to neatly install and isolate cabling from rear of TV as to not create possibility of electric shock / fire hazard.

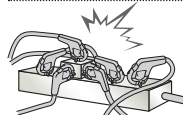

- Do not plug too many electrical devices into a single multiple electrical outlet. Otherwise, this may result in fire due to over-heating.

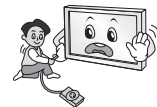

- Do not drop the product or let it fall over when connecting external devices. Otherwise, this may result in injury or damage to the product.



- Keep the packing anti-moisture material or vinyl packing out of the reach of children. Anti-moisture material is harmful if swallowed. If swallowed by mistake, force the patient to vomit and visit the nearest hospital. Additionally, vinyl packing can cause suffocation. Keep it out of the reach of children.



- Do not let your children climb or cling onto the TV. Otherwise, the TV may fall over, which may cause serious injury.



- Dispose of used batteries carefully to protect a child from eating them. Please seek Doctor- Medical Attention immediately if child consumes batteries.



- Do not insert any metal objects/conductors (like a metal chopstick/cutlery/ screwdriver) between power cable plug and input Wall Socket while it is connected to the input terminal on the wall. Additionally, do not touch the power cable right after plugging into the wall input terminal. You may be electrocuted. (Depending on model)

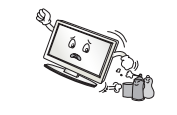

- Do not put or store inflammable substances near the product. There is a danger of combustion/ explosion or fire due to careless handling of the inflammable substances.



- Do not drop metallic objects such as coins, hair pins, chopsticks or wire into the product, or inflammable objects such as paper and matches. Children must pay particular attention. Electrical shock, fire or injury can occur. If a foreign object is dropped into the product, unplug the power cord and contact the service centre.



- Do not spray water on the product or scrub with an inflammable substance (thinner or benzene). Fire or electric shock accident can occur.



- Do not allow any impact, shock or any objects to fall into the unit, and do not drop anything onto the screen. You may be injured or the product can be damaged.



- Never touch this product or antenna during a thunder or lighting storm. You may be electrocuted.

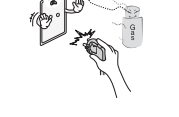

- Never touch the wall outlet when there is leakage of gas, open the windows and ventilate. It may cause a fire or a burn by a spark.



- Do not disassemble, repair or modify the product at your own discretion. Fire or electric shock accident can occur. Contact the service centre for check, calibration or repair.



- If any of the following occur, unplug the product immediately and contact your local service centre.
  - The product has been impacted by shock
  - The product has been damaged
  - Foreign objects have entered the product
  - The product produced smoke or a strange smell
 This may result in fire or electric shock.



- Unplug the TV from AC mains wall socket if you do not intend to use the TV for a long period of time. Accumulated dust can cause fire hazard and insulation deterioration can cause electric leakage/shock/fire.

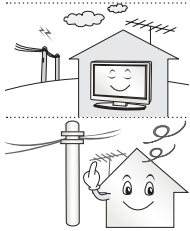

- Apparatus shall not be exposed to dripping or splashing and no objects filled with liquids, such as vases, shall be placed on the apparatus.

**CAUTION**

- Install the product where no radio wave occurs.



- There should be enough distance between an outside antenna and power lines to keep the former from touching the latter even when the antenna falls. This may cause an electric shock.



- Do not install the product on places such as unstable shelves or inclined surfaces. Also avoid places where there is vibration or where the product cannot be fully supported. Otherwise, the product may fall or flip over, which may cause injury or damage to the product.

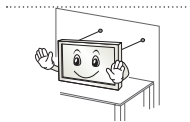

- If you install the TV on a stand, you need to take actions to prevent the product from overturning. Otherwise, the product may fall over, which may cause injury.

- If you intend to mount the product to a wall, attach VESA standard mounting interface (optional parts) to the back of the product. When you install the set to use the wall mounting bracket (optional parts), fix it carefully so as not to drop.
- Only use the attachments / accessories specified by the manufacturer.



- When installing the antenna, consult with a qualified service technician. If not installed by a qualified technician, this may create a fire hazard or an electric shock hazard.

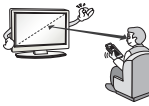

- We recommend that you maintain a distance of at least 2 to 7 times the diagonal screen size when watching TV. If you watch TV for a long period of time, this may cause blurred vision.

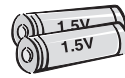

- Only use the specified type of battery. This could cause damage to the remote control.

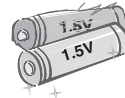

- Do not mix new batteries with old batteries. This may cause the batteries to overheat and leak.

- Batteries should not be exposed to excessive heat. eg keep away from direct Sunlight, open fireplace and electric heaters.
- Do not place non-rechargeable batteries in charging device.

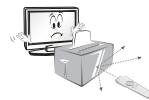

- Make sure there are no objects between the remote control and its sensor.



- Signal from Remote Control can be interrupted due to external/internal lighting eg Sunlight, fluorescent lighting. If this occurs turn off lighting or darken viewing area.



- When connecting external devices such as video game consoles, make sure the connecting cables are long enough. Otherwise, the product may fall over, which may cause injury or damage the product.



- Do not turn the product On/Off by plugging-in or unplugging the power plug to the wall outlet. (Do not use the power plug for switch.) It may cause mechanical failure or could give an electric shock.



- Please follow the installation instructions below to prevent the product from overheating.
  - The distance between the product and the wall should be more than 10 cm.
  - Do not install the product in a place with no ventilation (e.g., on a bookshelf or in a cupboard).
  - Do not install the product on a carpet or cushion.
  - Make sure the air vent is not blocked by a tablecloth or curtain.

Otherwise, this may result in fire.

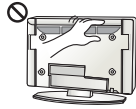

- Take care not to touch the ventilation openings when watching the TV for long periods as the ventilation openings may become hot. This does not affect the operation or performance of the product.

- Periodically examine the cord of your appliance, and if its appearance indicates damage or deterioration, unplug it, discontinue use of the appliance, and have the cord replaced with an exact replacement part by an authorized servicer.



- Prevent dust collecting on the power plug pins or outlet. This may cause a fire hazard.

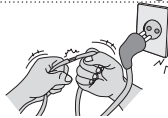

- Protect the power cord from physical or mechanical abuse, such as being twisted, kinked, pinched, closed in a door, or walked upon. Pay particular attention to plugs, wall outlets, and the point where the cord exits the appliance.



- Do not press strongly upon the panel with a hand or sharp object such as nail, pencil or pen, or make a scratch on it as it may cause damage to screen.



- Avoid touching the screen or holding your finger(s) against it for long periods of time. Doing so may produce some temporary or permanent distortion/damage to screen.



- When cleaning the product and its components, unplug the power first and wipe it with a soft cloth. Applying excessive force may cause scratches or discoloration. Do not spray with water or wipe with a wet cloth. Never use glass cleaner, car or industrial shiner, abrasives or wax, benzene, alcohol etc., which can damage the product and its panel. Otherwise, this may result in fire, electric shock or product damage (deformation, corrosion or breakage).

- As long as this unit is connected to the AC wall outlet, it is not disconnected from the AC power source even if you turn off this unit by SWITCH.



- When unplugging the cable, grab the plug and unplug it, by pulling at the plug. Don't pull at the cord to unplug the power cord from the power board, as this could be hazardous.



- When moving the product, make sure you turn the power off first. Then, unplug the power cables, antenna cables and all connecting cables. The TV set or power cord may be damaged, which may create a fire hazard or cause electric shock.



- When moving or unpacking the product, work in pairs because the product is heavy. Otherwise, this may result in injury.



- Contact the service centre once a year to clean the internal parts of the product. Accumulated dust can cause mechanical failure.



- Refer all servicing to qualified service personnel. Servicing is required when the apparatus has been damaged in any way, such as power supply cord or plug is damaged, liquid has been spilled or objects have fallen into the apparatus, the apparatus has been exposed to rain or moisture, does not operate normally, or has been dropped.



- If the product feels cold to the touch, there may be a small "flicker" when it is turned on. This is normal, there is nothing wrong with product.



- The panel is a high technology display product with resolution of two million to six million pixels. You may see tiny black dots and/or brightly coloured dots (red, blue or green) at a size of 1 ppm on the panel. This does not indicate a malfunction and does not affect the performance and reliability of the product. This phenomenon also occurs in third-party products and is not subject to exchange or refund.



- You may find different brightness and colour of the panel depending on your viewing position (left/right/top/down). This phenomenon occurs due to the characteristic of the panel. It is not related with the product performance, and it is not malfunction.



- Displaying a still image (e.g., broadcasting channel logo, on-screen menu, scene from a video game) for a prolonged time may cause damage to the screen, resulting in retention of the image, which is known as image sticking. The warranty does not cover the product for image sticking.

Avoid displaying a fixed image on your television's screen for a prolonged period (2 or more hours for LCD, 1 or more hours for Plasma).

Also, if you watch the TV at a ratio of 4:3 for a long time, image sticking may occur on the borders of the panel.

This phenomenon also occurs in third-party products and is not subject to exchange or refund.

- **Generated Sound**

"Cracking" noise: A cracking noise that occurs when watching or turning off the TV is generated by plastic thermal contraction due to temperature and humidity. This noise is common for products where thermal deformation is required. Electrical circuit humming/panel buzzing: A low level noise is generated from a high-speed switching circuit, which supplies a large amount of current to operate a product. It varies depending on the product.

This generated sound does not affect the performance and reliability of the product.

## Viewing 3D Imaging (Only 3D models)

### WARNING

#### Viewing Environment

- Viewing Time
  - When watching 3D contents, take 5 - 15 minute breaks every hour. Viewing 3D contents for a long period of time may cause headache, dizziness, fatigue or eye strain.

#### Those that have a photosensitive seizure or chronic illness

- Some users may experience a seizure or other abnormal symptoms when they are exposed to a flashing light or particular pattern from 3D contents.
- Do not watch 3D videos if you feel nausea, are pregnant and/ or have a chronic illness such as epilepsy, cardiac disorder, or blood pressure disease, etc.
- 3D Contents are not recommended to those who suffer from stereo blindness or stereo anomaly. Double images or discomfort in viewing may be experienced.
- If you have strabismus (cross-eyed), amblyopia (weak eyesight) or astigmatism, you may have trouble sensing depth and easily feel fatigue due to double images. It is advised to take frequent breaks than the average adult.
- If your eyesight varies between your right and left eye, revise your eyesight prior to watching 3D contents.

#### Symptoms which require discontinuation or refraining from watching 3D contents

- Do not watch 3D contents when you feel fatigue from lack of sleep, overwork or drinking.
- When these symptoms are experienced, stop using/ watching 3D contents and get enough rest until the symptom subsides.
  - Consult your doctor when the symptoms persist. Symptoms may include headache, eyeball pain, dizziness, nausea, palpitation, blurriness, discomfort, double image, visual inconvenience or fatigue.

### CAUTION

#### Viewing Environment

- Viewing Distance
  - Maintain a distance of at least twice the screen diagonal length when watching 3D contents. If you feel discomfort in viewing 3D contents, move further away from the TV.

#### Viewing Age

- Infants/Children
  - Usage/ Viewing 3D contents for children under the age of 5 are prohibited.
  - Children under the age of 10 may overreact and become overly excited because their vision is in development (for example: trying to touch the screen or trying to jump into it. Special monitoring and extra attention is required for children watching 3D contents.
  - Children have greater binocular disparity of 3D presentations than adults because the distance between the eyes is shorter than one of adults. Therefore they will perceive more stereoscopic depth compared to adults for the same 3D image.
- Teenagers
  - Teenagers under the age of 19 may react with sensitivity due to stimulation from light in 3D contents. Advise them to refrain from watching 3D contents for a long time when they are tired.
- Elderly
  - The elderly may perceive less 3D effect compared to the youth. Do not sit closer to the TV than the recommended distance.

#### Cautions when using the 3D glasses

- Make sure to use LG 3D glasses. Otherwise, you may not be able to view 3D videos properly.
- Do not use 3D glasses instead of your normal glasses, sunglasses or protective goggles.
- Using modified 3D glasses may cause eye strain or image distortion.
- Do not keep your 3D glasses in extremely high or low temperatures. It will cause deformation.
- The 3D glasses are fragile and are easy to be scratched. Always use a soft, clean piece of cloth when wiping the lenses. Do not scratch the lenses of the 3D glasses with sharp objects or clean/wipe them with chemicals.



**NOTE**

- Image shown may differ from your TV.
- Your TV's OSD (On Screen Display) may differ slightly from that shown in this manual.
- The available menus and options may differ from the input source or product model that you are using.
- New features may be added to this TV in the future.
- The TV can be placed in standby mode in order to reduce the power consumption. And the TV should be turned off if it will not be watched for some time, as this will reduce energy consumption.
- The energy consumed during use can be significantly reduced if the level of brightness of the picture is reduced, and this will reduce the overall running cost.

## INSTALLATION PROCEDURE

- 1 Open the package and make sure all the accessories are included.
- 2 Attach the stand to the TV set.
- 3 Connect an external device to the TV set.

## ASSEMBLING AND PREPARING

### Unpacking

Check your product box for the following items. If there are any missing accessories, contact the local dealer where you purchased your product. The illustrations in this manual may differ from the actual product and item.

**CAUTION**

- Do not use any unapproved items to ensure the safety and product life span.
- Any damages or injuries by using unapproved items are not covered by the manufacturer's warranty.
- Some models have a thin film attached on to the screen and this must not be removed.

**NOTE**

- The items supplied with your product may vary depending on the model.
- Product specifications or contents of this manual may be changed without prior notice due to upgrade of product functions.
- For an optimal connection, HDMI cables and USB devices should have bezels less than 10 mm thick and 18 mm width. Use an extension cable that supports USB 2.0 if the USB cable or USB memory stick does not fit into your TV's USB port.

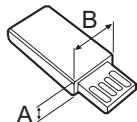
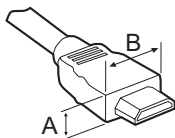

\*A ≤ 10 mm

\*B ≤ 18 mm

ENGLISH

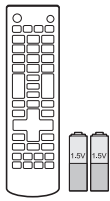

**Remote control and batteries (AAA)**  
(See p.24, 25)

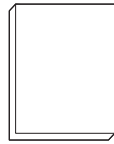

**Owner's manual**

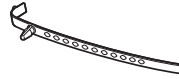

**Cable holder**  
(Depending on model)  
(See p.18)



**Power Cord**

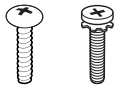

**Stand Screws**  
3EA, P5 x 25  
4EA, M4 x 14  
(Only LN54\*\*, LN565\*)  
(See p.14)



**Desk-mount Screw**  
(2EA : Only LA61\*\*)  
(1EA : Only  
32/37/39/42/47/50/  
60LN54\*\*, LN565\*)  
(See p.16)



**Stand Screws**  
8EA, M4 x 14  
(Only LA61\*\*)  
(See p.14)



**Desk-mount Cable**  
2EA  
(Only LA61\*\*)  
(See p.16)



**Bracket Screw**  
2EA, M4 x 8  
(Only 32/42LA61\*\*)  
2EA, P4 x 8  
(Only 50LA61\*\*)  
(See p.16)

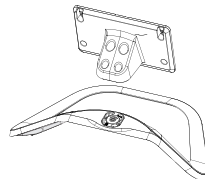

**Stand Body / Stand Base**  
(Only LA61\*\*)  
(See p.14)

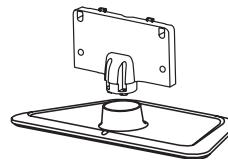

**Stand Body / Stand Base**  
(Only LN54\*\*, LN565\*)  
(See p.14)



**Cinema 3D Glasses**  
The number of 3D glasses may differ depending on the model or country.  
(Only LA61\*\*)

### Separate purchase

Separate purchase items can be changed or modified for quality improvement without any notification.  
 Contact your dealer to buy these items.  
 These devices only work with certain models.



**AG-F2\*\*, AG-F3\*\*, AG-F4\*\***  
 Cinema 3D glasses



**AG-F2\*\*DP, AG-F3\*\*DP**  
 Dual play glasses



LG Audio Device

Compatibility	LA61**	LN54**, LN565*
<b>AG-F2**, AG-F3**, AG-F4**</b> Cinema 3D glasses	•	
<b>AG-F2**DP, AG-F3**DP</b> Dual play glasses	•	
LG Audio Device	•	

The model name or design may be changed depending on the upgrade of product functions, manufacturer's circumstances or policies.

ENGLISH

## Parts and buttons

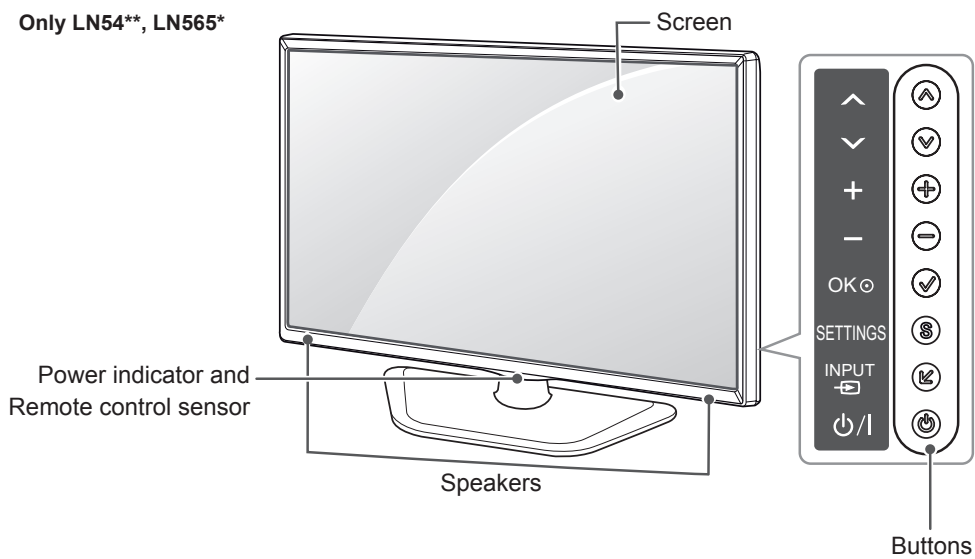
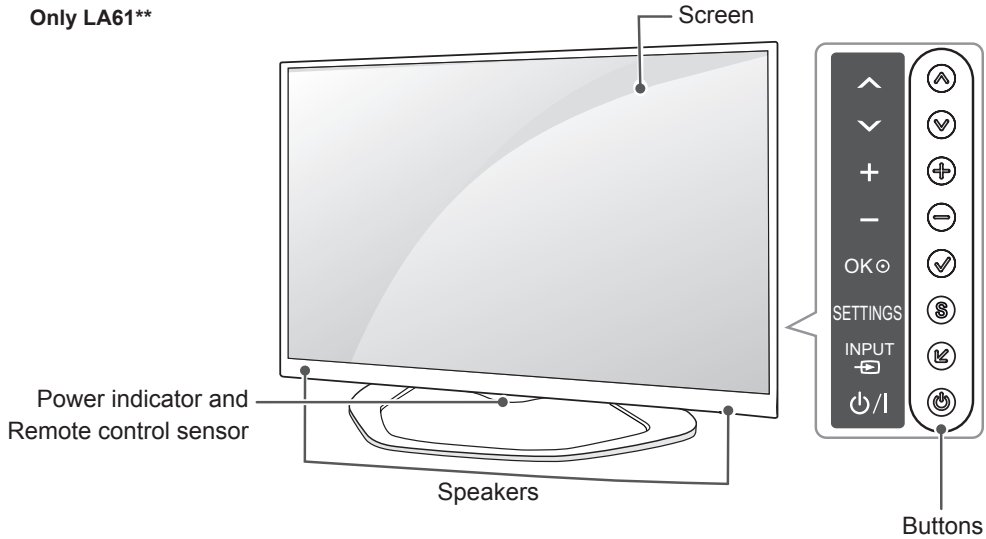

Button	Description
^ v	Scrolls through the saved programmes.
+ -	Adjusts the volume level.
✓	Selects the highlighted menu option or confirms an input.
S	Accesses the main menu, or saves your input and exits the menus.
↵	Changes the input source.
⏻	Turns the power on or off.

**NOTE**

- You can set the power indicator light to on or off by selecting **OPTION** in the main menus.

## Lifting and moving the TV

Please note the following advice to prevent the TV from being scratched or damaged and for safe transportation regardless of its type and size.



### CAUTION

- Avoid touching the screen at all times, as this may result in damage to the screen.
- It is recommended to move the TV in the box or packing material that the TV originally came in.
- Before moving or lifting the TV, disconnect the power cord and all cables.
- When holding the TV, the screen should face away from you to avoid damage.

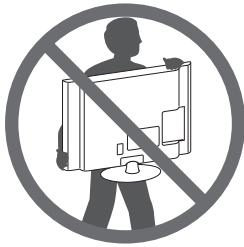

- Hold the top and bottom of the TV frame firmly. Make sure not to hold the transparent part, speaker, or speaker grill area.

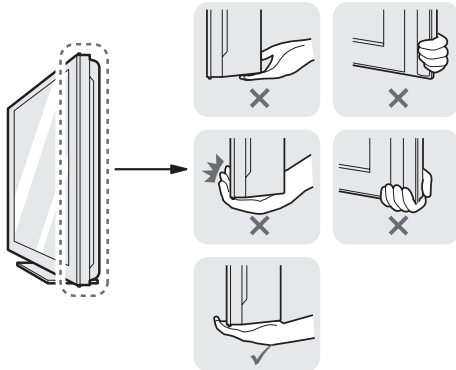

- When transporting a large TV, there should be at least 2 people.
- When transporting the TV by hand, hold the TV as shown in the following illustration.

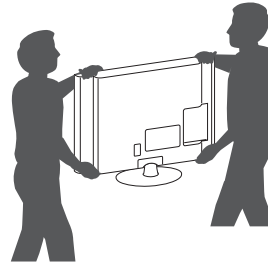

- When transporting the TV, do not expose the TV to jolts or excessive vibration.
- When transporting the TV, keep the TV upright, never turn the TV on its side or tilt towards the left or right.
- Do not apply excessive pressure to cause flexing / bending of frame chassis as it may damage screen.

ENGLISH

## Setting up the TV

Image shown may differ from your TV.

### Attaching the stand

LN54\*\*, LN565\*

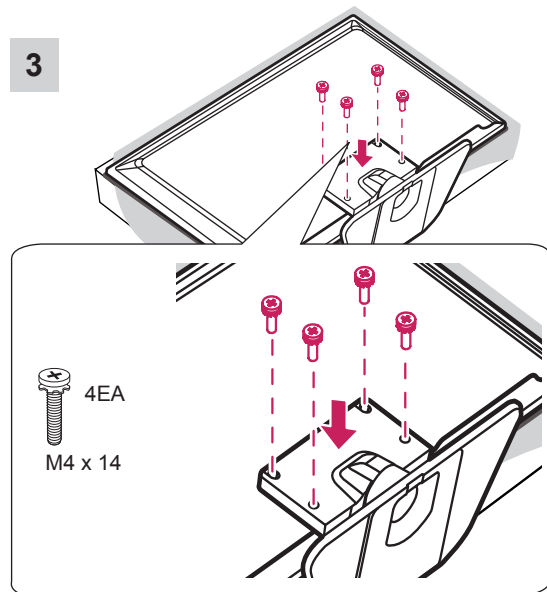
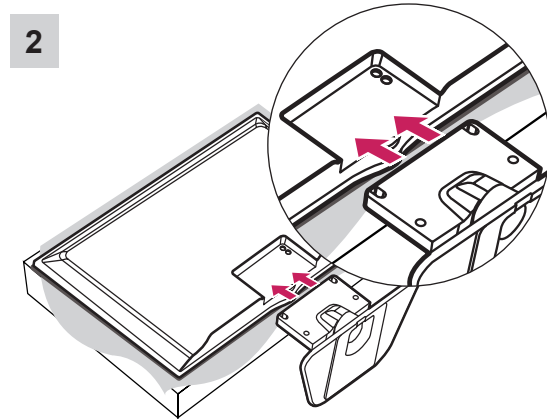
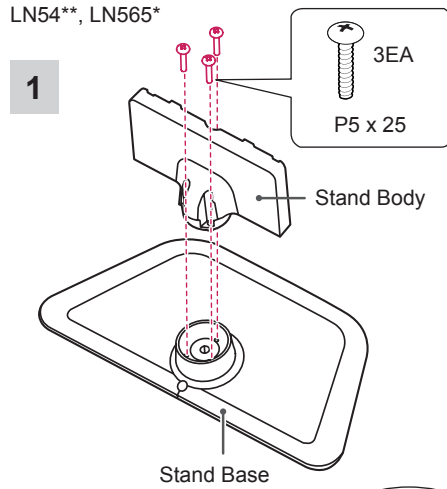

LA61\*\*

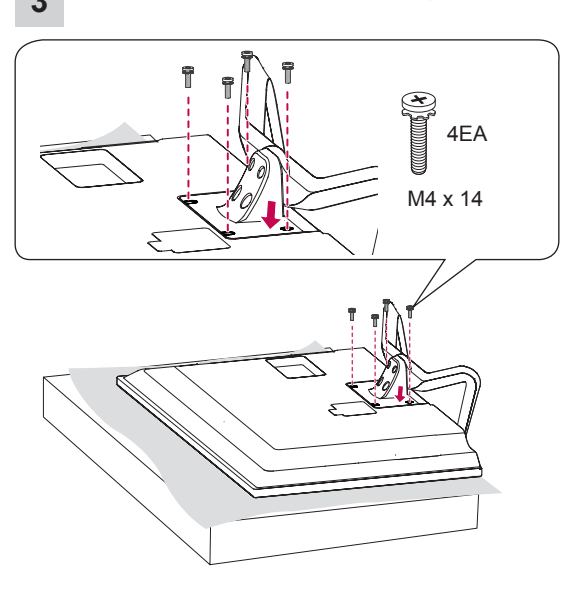
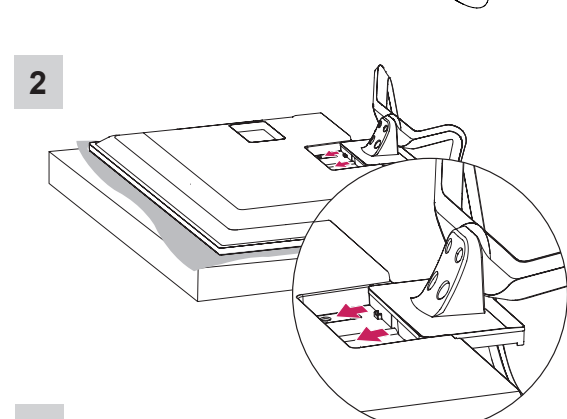
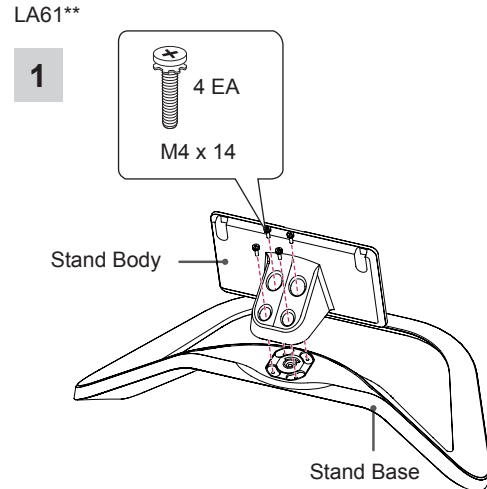



**CAUTION**

- When attaching the stand to the TV set, place the screen facing down on a cushioned table or flat surface to protect the screen from scratches.
- Make sure that the screws are inserted correctly and fastened securely. (If they are not fastened securely enough, the TV may tilt forward after being installed.)  
Do not use too much force and over tighten the screws; otherwise screw may be damaged and not tighten correctly.



**NOTE**

- Remove the stand before installing the TV on a wall mount by performing the stand attachment in reverse.

**Mounting on a table**

- 1 Lift and tilt the TV into its upright position on a table.
  - Leave a 10 cm (minimum) space from the wall for proper ventilation.

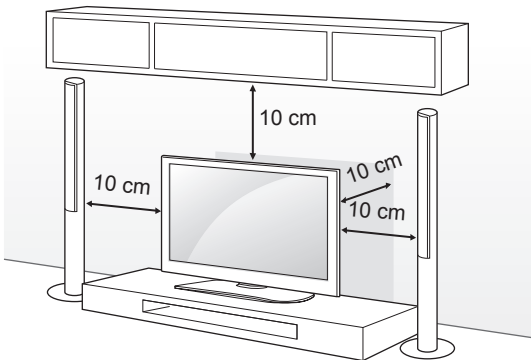

- 2 Connect the power cord to a wall outlet.



**CAUTION**

- Do not place the TV near or on sources of heat, as this may result in fire or other damage.

**Using the Kensington security system**

(This feature is not available for all models.)  
The Kensington security system connector is located at the rear of the TV. For more information of installation and using, refer to the manual provided with the Kensington security system or visit <http://www.kensington.com>.

Connect the Kensington security system cable between the TV and a table.

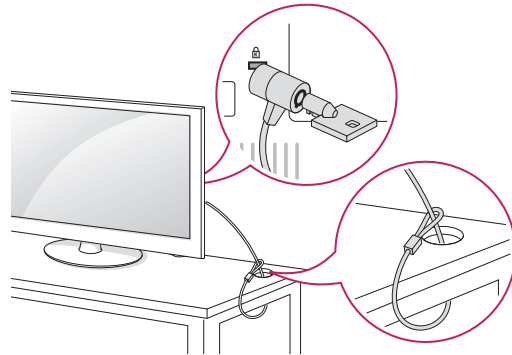

**Adjusting the angle of the TV to suit view**

(Only LA61\*\*)  
Swivel 15 degrees to the left or right and adjust the angle of the TV to suit your view.

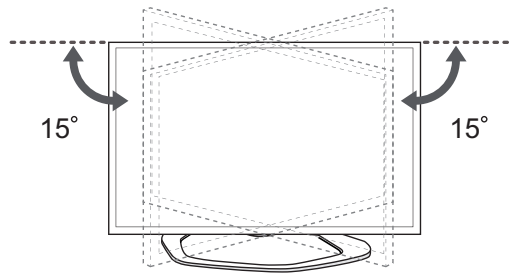

**CAUTION**

- » When adjusting the angle of the product, watch out for your fingers.
- » Personal injury may occur if hands or fingers are pinched. If the product is tilted too much, it may fall, causing damage or injury.

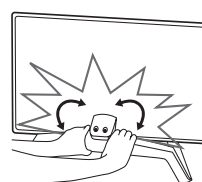

<Rear>

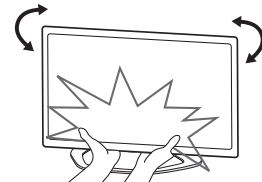

<Front>

ENGLISH

**Securing the TV to a table**

Fix the TV to a table to prevent from tilting forward, damage, and potential injury.

To secure the TV to a table, insert and tighten the supplied screw on the rear of the stand.  
(Only 32/37/39/42/47/50/60LN54\*\*, LN565\*)

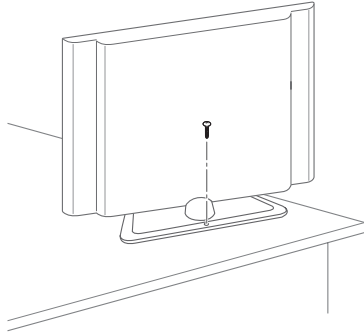

(Only LA61\*\*)

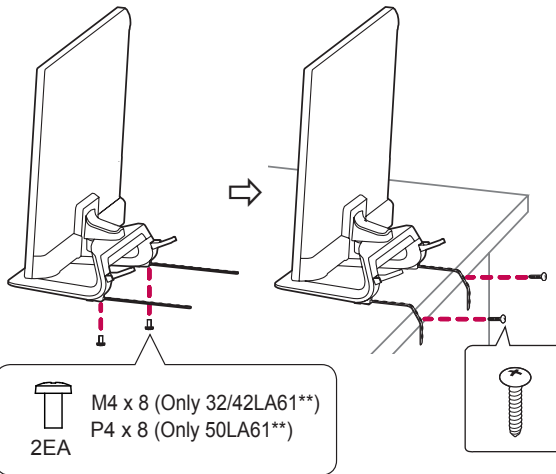

**CAUTION**  
(Only LA61\*\*)

**How to fix the TV to a table**

- 1 . Connect the Desk-mount Cables to the Stand Base using the Bracket Screws.
- 2 . Fix the Desk-mount Cables to a table using the Desk-mount Screws.
- 3 . Once the TV is fixed, move the table close to the wall. Children may go in, causing injuries.

**WARNING**

- To prevent TV from falling over, the TV should be securely attached to the floor/wall per installation instructions. Tipping, shaking, or rocking the TV may cause injury.

**Securing the TV to a wall**

(This feature is not available for all models.)

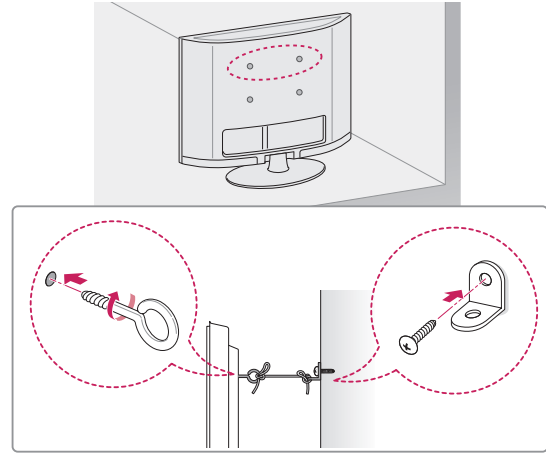

- 1 Insert and tighten the eye-bolts, or TV brackets and bolts on the back of the TV.
  - If there are bolts inserted at the eye-bolts position, remove the bolts first.
- 2 Mount the wall brackets with the bolts to the wall. Match the location of the wall bracket and the eye-bolts on the rear of the TV.
- 3 Connect the eye-bolts and wall brackets tightly with a sturdy rope. Make sure to keep the rope horizontal with the flat surface.

**CAUTION**

- Make sure that children do not climb on or hang on the TV.

**NOTE**

- Use a platform or cabinet that is strong and large enough to support the TV securely.
- Brackets, bolts and ropes are not provided. You can obtain additional accessories from your local dealer.



**! WARNING**

- If a television is not positioned in a sufficiently stable location, it can be potentially hazardous due to falling. Many injuries, particularly to children, can be avoided by taking simple precautions such as:
  - » Using cabinets or stands recommended by the manufacturer of the television.
  - » Only using furniture that can safely support the television.
  - » Ensuring the television is not overhanging the edge of the supporting furniture.
  - » Not placing the television on tall furniture (for example, cupboards or bookcases) without anchoring both the furniture and the television to a suitable support.
  - » Not standing the televisions on cloth or other materials placed between the television and supporting furniture.
  - » Educating children about the dangers of climbing on furniture to reach the television or its controls.

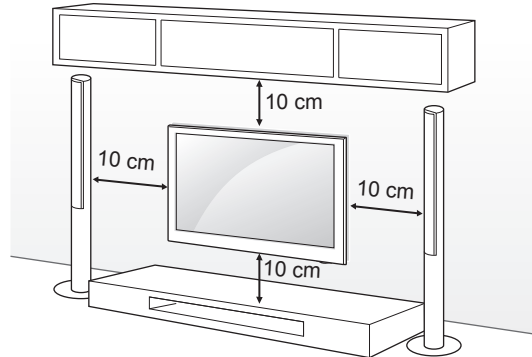

**Mounting on a wall**

Attach an optional wall mount bracket at the rear of the TV carefully and install the wall mount bracket on a solid wall perpendicular to the floor. When you attach the TV to other building materials, please contact qualified personnel.  
 LG recommends that wall mounting be performed by a qualified professional installer.

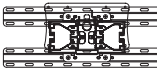

Make sure to use screws and wall mount bracket that meet the VESA standard. Standard dimensions for the wall mount kits are described in the following table.

**Separate purchase(Wall Mounting Bracket)**

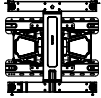
<b>Model</b>	32LN54** 32LN565* 32LA61**	37/39/42LN54** 42LA61**
<b>VESA (A x B)</b>	200 x 100	200 x 200
<b>Standard screw</b>	M4	M6
<b>Number of screws</b>	4	4
<b>Wall mount bracket</b>	LSW130B 	LSW230B 
<b>Model</b>	47/50/55/60LN54** 50LA61**	
<b>VESA (A x B)</b>	400 x 400	
<b>Standard screw</b>	M6	
<b>Number of screws</b>	4	
<b>Wall mount bracket</b>	LSW430B 	

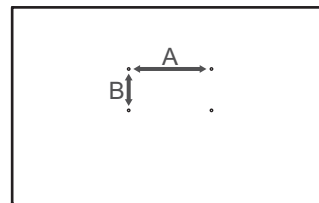

**CAUTION**

- Disconnect the power first, and then move or install the TV. Otherwise electric shock may occur.
- If you install the TV on a ceiling or slanted wall, it may fall and result in severe injury. Use an authorized LG wall mount and contact the local dealer or qualified personnel.
- Do not over tighten the screws as this may cause damage to the TV and void your warranty.
- Use the screws and wall mounts that meet the VESA standard. Any damages or injuries by misuse or using an improper accessory are not covered by the manufacturer's warranty.

**NOTE**

- Use the screws that are listed on the VESA standard screw specifications.
- The wall mount kit includes an installation manual and necessary parts.
- The wall mount bracket is not provided. You can obtain additional accessories from your local dealer.
- The length of screws may differ depending on the wall mount. Make sure to use the proper length.
- For more information, refer to the manual supplied with the wall mount.

**Tidying cables**

(Only LA61\*\*)

- 1 Use Cable Holder to neatly secure and position cables together.
- 2 Fix the Cable Management firmly to the TV.

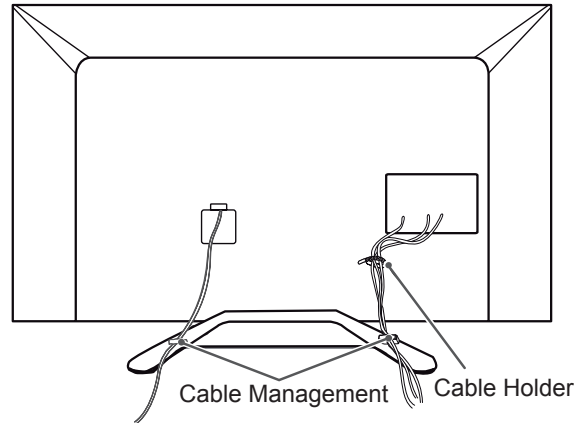

(Only LN54\*\*, LN565\*)

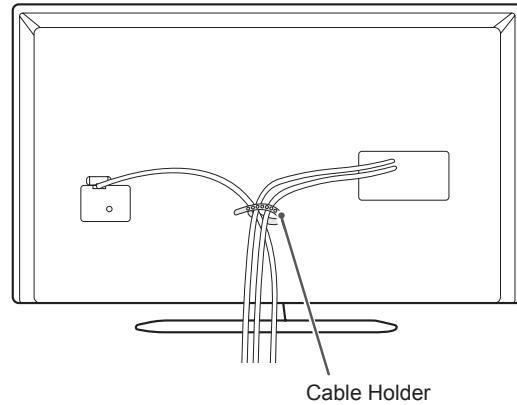
**Use Cable Holder to neatly secure and position cables together.****CAUTION**

- Do not move the TV by holding the cable holder, as the cable holders may break, and injuries and damage to the TV may occur.

## MAKING CONNECTIONS

This section on **MAKING CONNECTIONS** mainly uses diagrams for the LN54\*\* models.

Connect various external devices to the TV and switch input modes to select an external device. For more information of external device's connection, refer to the manual provided with each device.

Available external devices are: HD receivers, DVD players, VCRs, audio systems, USB storage devices, PC, gaming devices, and other external devices.

### NOTE

- The external device connection may differ from the model.
- Connect external devices to the TV regardless of the order of the TV port.
- If you record a TV programme on a DVD recorder or VCR, make sure to connect the TV signal input cable to the TV through a DVD recorder or VCR. For more information of recording, refer to the manual provided with the connected device.
- Refer to the external equipment's manual for operating instructions.
- If you connect a gaming device to the TV, use the cable supplied with the gaming device.
- In PC mode, there may be noise associated with the resolution, vertical pattern, contrast or brightness. If noise is present, change the PC output to another resolution, change the refresh rate to another rate or adjust the brightness and contrast on the PICTURE menu until the picture is clear.
- In PC mode, some resolution settings may not work properly depending on the graphics card.

## Antenna connection

Connect the TV to a wall antenna socket with an RF cable (75  $\Omega$ ).

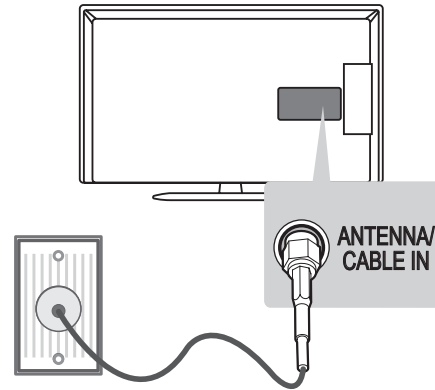

### NOTE

- Use a signal splitter to use more than 2 TVs.
- If the image quality is poor, install a signal amplifier properly to improve the image quality.
- If the image quality is poor with an antenna connected, try to realign the antenna in the correct direction.
- An antenna cable and converter are not supplied.
- Supported DTV Audio: MPEG, Dolby Digital, Dolby Digital Plus, HE-AAC

ENGLISH

### HDMI connection

Transmits the digital video and audio signals from an external device to the TV. Connect the external device and the TV with the HDMI cable as shown.

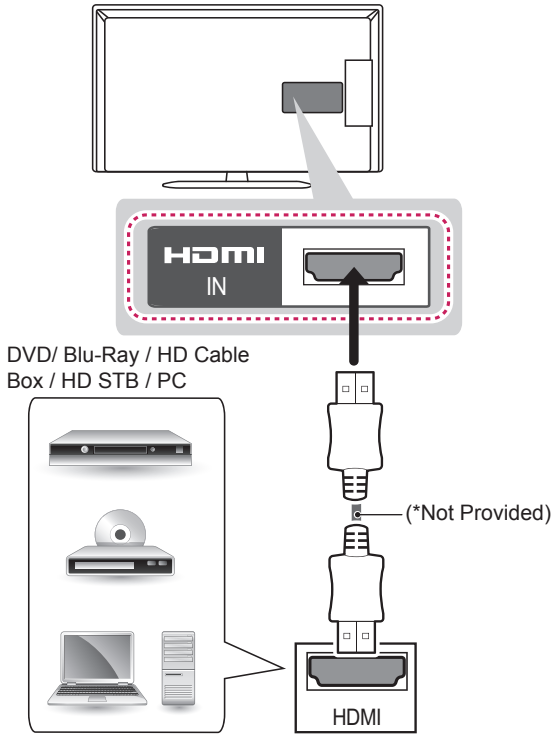

**NOTE**

- It is recommended to use the TV with the HDMI connection for the best image quality.
- Use the latest High Speed HDMI™ Cable with CEC (Customer Electronics Control) function.
- High Speed HDMI™ Cables are tested to carry an HD signal up to 1080p and higher.
- Supported HDMI Audio format : Dolby Digital, DTS, PCM (Up to 192 kHz, 32k/44.1k/48k/88k/96k/176k/192k)(Only LA61\*\*, LN565\*)
- Supported HDMI Audio format : Dolby Digital, PCM (Up to 192 kHz, 32k/44.1k/48k/88k/96k/176k/192k) \*DTS Not Supported. (Only LN54\*\*)
- If you use DVI to HDMI cable for PC, you have to use external speaker for PC audio sound.

### Component connection

Transmits analog video and audio signals from an external device to the TV. Connect the external device and the TV with a component cable as shown.

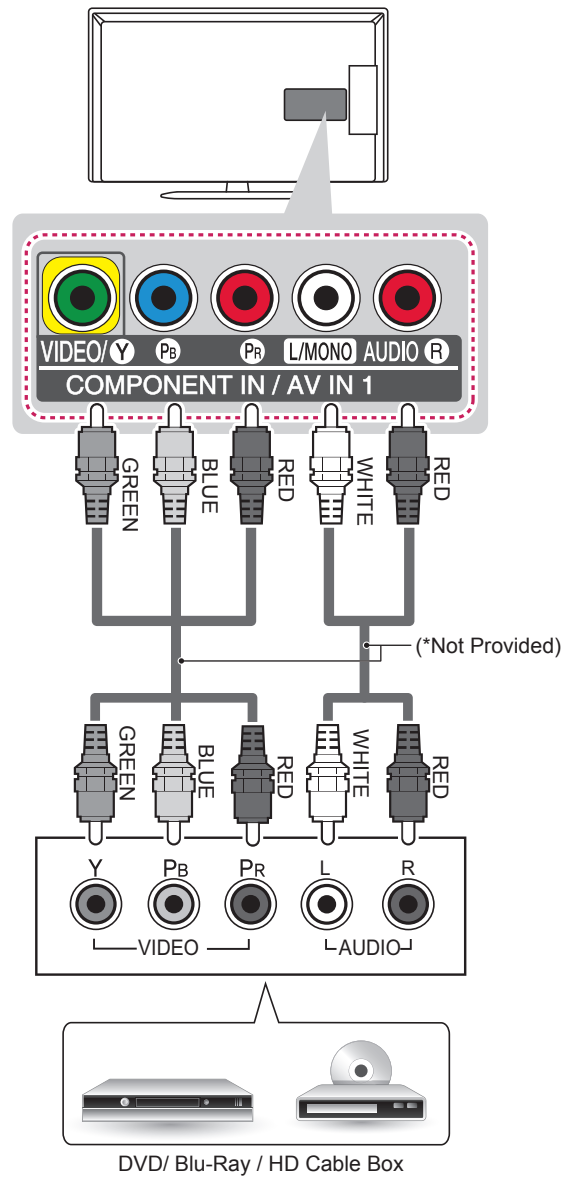

**NOTE**

- If cables are not installed correctly, it could cause this image to display in black and white or with distorted colours.

### Composite connection

Transmits analog video and audio signals from an external device to the TV. Connect the external device and the TV with the composite cable as shown.

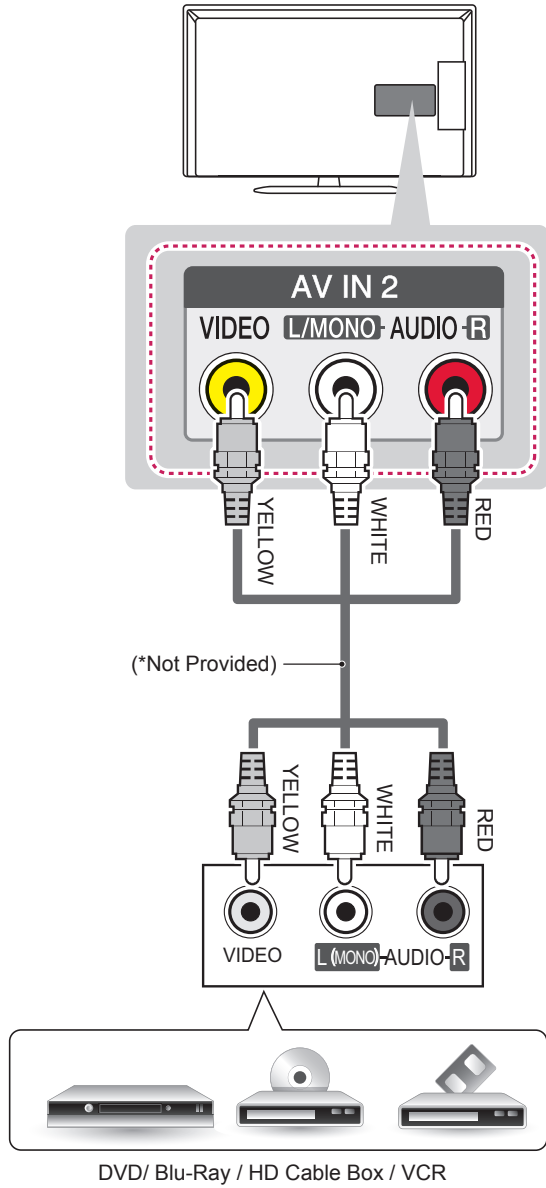

### USB connection

Connect a USB storage device such as a USB flash memory, external hard drive, or a USB memory card reader to the TV and access the My media menu to use various multimedia files.

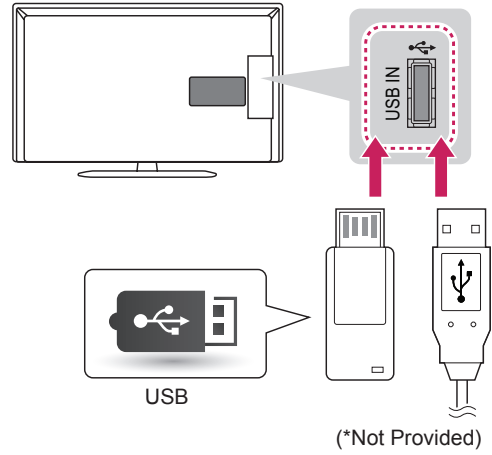

## Headphone connection

Transmits the headphone signal from the TV to an external device. Connect the external device and the TV with the headphone as shown.

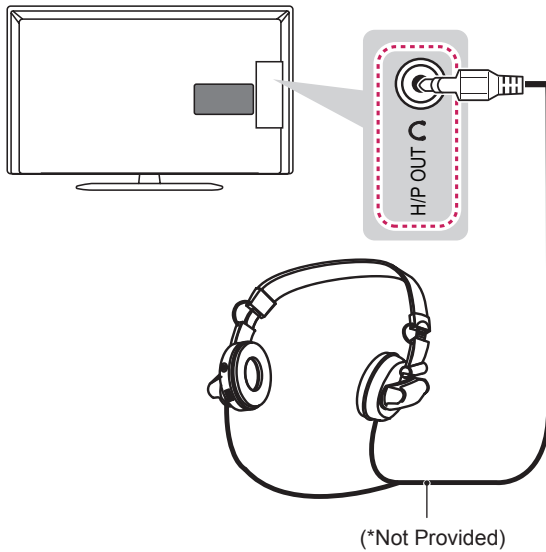

### ! NOTE

- **AUDIO** menu items are disabled when connecting a headphone.
- When changing **AV MODE** with a headphone connected, the change is applied to video but not to audio.
- **Optical Digital Audio Out** is not available when connecting a headphone. (Only LA61\*\*)
- Headphone impedance: 16  $\Omega$
- Max audio output of headphone: 9 mW to 15 mW
- Headphone jack size: 0.35 cm

## Audio Connection

(Only LA61\*\*)

You may use an optional external audio system instead of the built-in speaker.

## Digital optical audio connection

Transmits a digital audio signal from the TV to an external device. Connect the external device and the TV with the optical audio cable as shown.

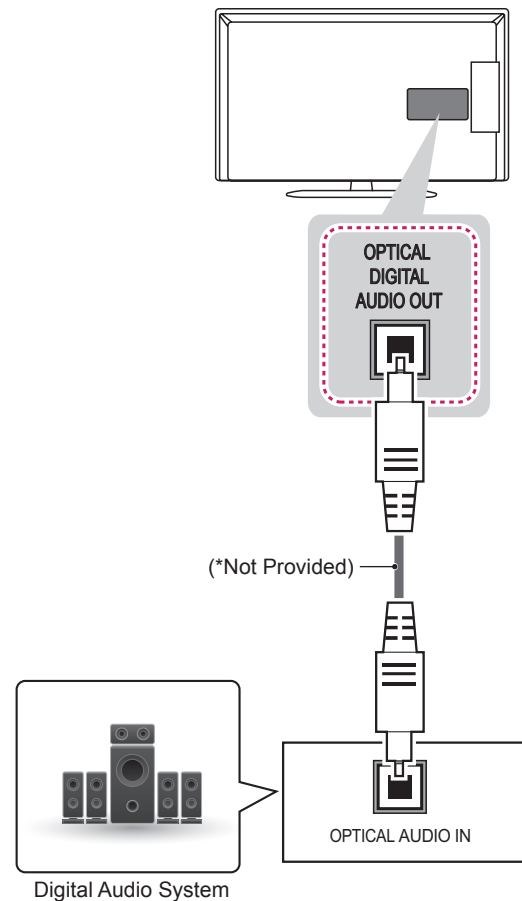

### ! NOTE

- Do not look into the optical output port. Looking at the laser beam may damage your vision.
- Audio with ACP (Audio Copy Protection) function may block digital audio output.

## MHL connection

Mobile High-definition Link (MHL) is an interface for transmitting digital audiovisual signals from mobile phones to television sets.

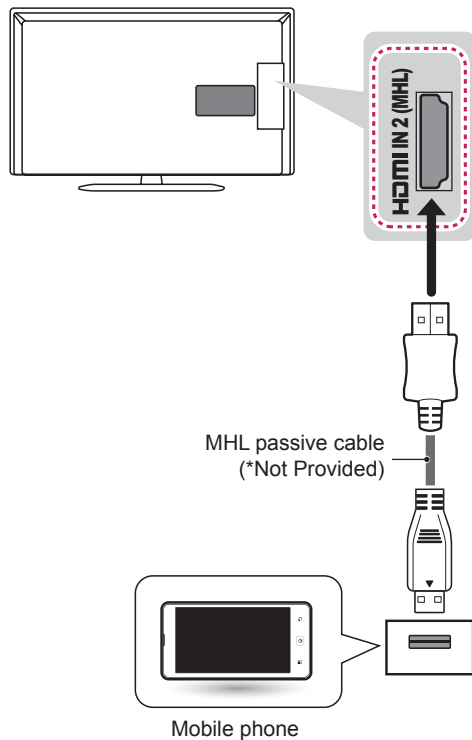

### ! NOTE

- Connect the mobile phone to the HDMI IN 2 (MHL) port to view the phone screen on the TV.
- The MHL passive cable is needed to connect the TV and a mobile phone.
- This only works for the MHL-enabled phone.
- Some applications can be operated by the remote control.
- Remove the MHL passive cable from the TV when:
  - The MHL function is disabled.
  - Your mobile device is fully charged in standby mode.

# REMOTE CONTROL

The descriptions in this manual are based on the buttons on the remote control.

Please read this manual carefully and use the TV correctly.

To replace batteries, open the battery cover, replace batteries (1.5 V AAA) matching the ⊕ and ⊖ ends to the label inside the compartment, and close the battery cover.

To remove the batteries, perform the installation actions in reverse.

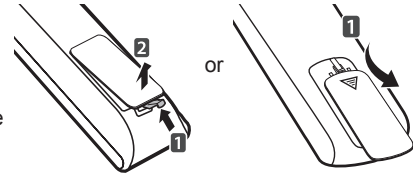

## CAUTION

- Do not mix old and new batteries, as this may damage the remote control.
- In Analogue TV and some countries, some remote control buttons may not work.

Make sure to point the remote control toward the remote control sensor on the TV.

(Only LA61\*\*)

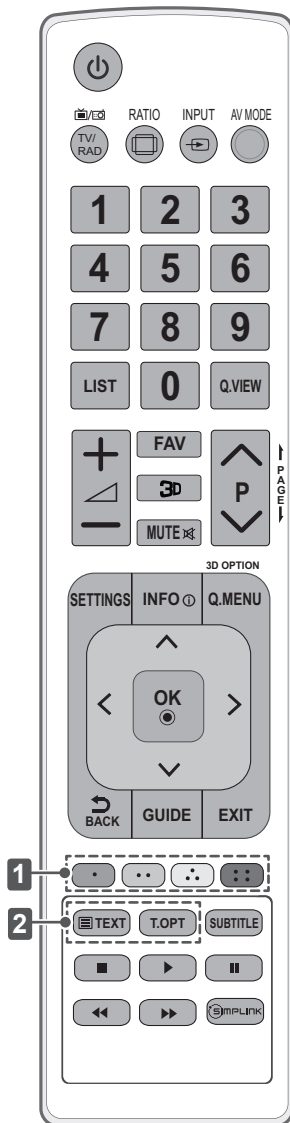

<b>⏻ (POWER)</b>	Turns the TV on or off.
<b>TV/RAD</b>	Selects Radio, TV and DTV programme.
<b>RATIO</b>	Resizes an image.
<b>INPUT</b>	Changes the input source.
<b>AV MODE</b>	Selects an AV mode.
<b>Number buttons</b>	Enters numbers.
<b>LIST</b>	Accesses the saved programme list.
<b>Q.VIEW</b>	Returns to the previously viewed programme.
<b>FAV</b>	Accesses your favourite programme list.
<b>3D</b>	Used for viewing 3D video.
<b>MUTE</b>	Mutes all sounds.
<b>△ + -</b>	Adjusts the volume level.
<b>P ^ v</b>	Scrolls through the saved programmes.
<b>← PAGE →</b>	Moves to the previous or next screen.
<b>SETTINGS</b>	Accesses the main menus.
<b>INFO</b>	Views the information of the current programme and screen.
<b>Q.MENU</b>	Accesses the Quick menus.
<b>3D OPTION</b>	Use this to view 3D video.
<b>Navigation buttons (up/down/left/right)</b>	Scrolls through menus or options.
<b>OK</b>	Selects menus or options and confirms your input.
<b>↶ BACK</b>	Returns to the previous level.
<b>GUIDE</b>	Shows programme guide.
<b>EXIT</b>	Clears on-screen displays and return to TV viewing.
<b>1 Coloured buttons</b> ( : Red,  : Green,  : Yellow,  : Blue)	These access special functions in some menus.
<b>2 TELETEXT BUTTONS</b>	These buttons are used for teletext.
<b>SUBTITLE</b>	Recalls your preferred subtitle in digital mode.
<b>Control buttons</b> ( ,  ,  ,  ,  )	Controls the MY MEDIA menus, or the SIMPLINK compatible devices (USB, SIMPLINK).
<b>SIMPLINK</b>	Accesses the AV devices connected with the HDMI cable through HDMI-CEC. Opens the SIMPLINK menu.



(Only LN54\*\*, LN565\*)

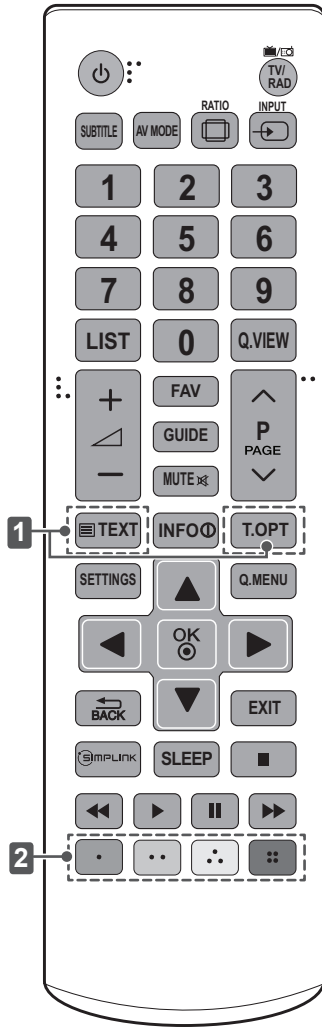

<b>⏻ (POWER)</b>	Turns the TV on or off.
<b>TV/RAD</b>	Selects Radio, TV and DTV programme.
<b>SUBTITLE</b>	Recalls your preferred subtitle in digital mode.
<b>AV MODE</b>	Selects an AV mode.
<b>RATIO</b>	Resizes an image.
<b>INPUT</b>	Changes the input source.
<b>Number buttons</b>	Enters numbers.
<b>LIST</b>	Accesses the saved programme list.
<b>Q.VIEW</b>	Returns to the previously viewed programme.
<b>FAV</b>	Accesses your favourite programme list.
<b>GUIDE</b>	Shows programme guide.
<b>MUTE</b>	Mutes all sounds.
<b>△ + -</b>	Adjusts the volume level.
<b>P ^ v</b>	Scrolls through the saved programmes.
<b>PAGE ^ v</b>	Moves to the previous or next screen.
<b>1 TELETEXT BUTTONS</b>	These buttons are used for teletext.
<b>INFO</b>	Views the information of the current programme and screen.
<b>SETTINGS</b>	Accesses the main menus.
<b>Q.MENU</b>	Accesses the Quick menus.
<b>Navigation buttons (up/down/left/right)</b>	Scrolls through menus or options.
<b>OK</b>	Selects menus or options and confirms your input.
<b>BACK</b>	Returns to the previous level.
<b>EXIT</b>	Clears on-screen displays and return to TV viewing.
<b>SIMPLINK</b>	Accesses the AV devices connected with the HDMI cable through HDMI-CEC. Opens the SIMPLINK menu.
<b>SLEEP</b>	Sets the sleep timer.
<b>Control buttons</b>	Controls the MY MEDIA menus, or the SIMPLINK compatible devices (USB, SIMPLINK).
<b>2 Coloured buttons</b>	These access special functions in some menus. ( : Red,  : Green,  : Yellow,  : Blue)

# USING THE USER GUIDE

User Guide allows you to more easily access the detailed TV information.

- 1 Press **SETTINGS** to access the main menus.
- 2 Press the **RED** button to access the Customer Support menus.
- 3 Press the Navigation buttons to scroll to **User Guide** and press **OK**.

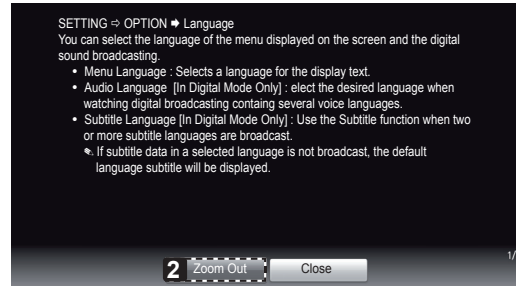
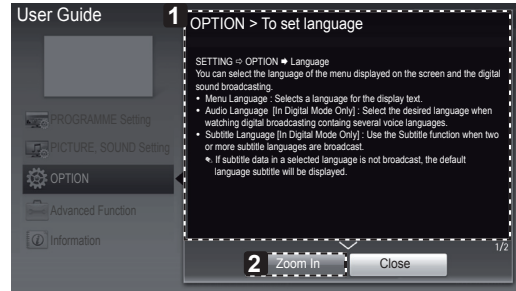
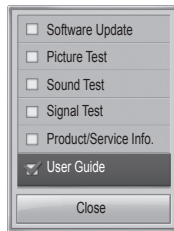

- 1 Shows the description of the selected menu. You can use ^/▼ to move between pages.
- 2 Zooms in or out the screen.

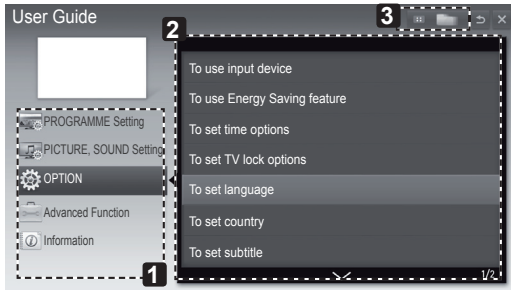

- 1 Allows to select the category you want.
- 2 Allows to select the item you want. You can use ^/▼ to move between pages.
- 3 Allows to browse the description of the function you want from the index.

# MAINTENANCE

## Cleaning your TV

Clean your TV regularly to keep the best performance and to extend the product lifespan.



### CAUTION

- Make sure to turn the power off and disconnect the power cord and all other cables first.
- When the TV is left unattended and unused for a long time, disconnect the power cord from the wall outlet to prevent possible damage from lightning or power surges.

## Screen, frame, cabinet and stand

- To remove dust or light dirt, wipe the surface with a dry, clean, and soft cloth.
- To remove major dirt, wipe the surface with a soft cloth dampened in clean water or a diluted mild detergent. Then wipe immediately with a dry cloth.



### CAUTION

- Avoid touching the screen at all times, as this may result in damage to the screen.
- Do not push, rub, or hit the screen surface with your fingernail or a sharp object, as this may result in scratches and image distortions.
- Do not use any chemicals as this may damage the product.
- Do not spray liquid onto the surface. If water enters the TV, it may result in fire, electric shock, or malfunction.

## Power cord

Remove the accumulated dust or dirt on the power cord regularly.

# TROUBLESHOOTING

Problem	Solution
Cannot control the TV with the remote control.	<ul style="list-style-type: none"> <li>• Check the remote control sensor on the product and try again.</li> <li>• Check if there is any obstacle between the product and the remote control.</li> <li>• Check if the batteries are still working and properly installed ( ⊕ to ⊕, ⊖ to ⊖ ).</li> </ul>
No image display and no sound is produced.	<ul style="list-style-type: none"> <li>• Check if the product is turned on.</li> <li>• Check if the power cord is connected to a wall outlet.</li> <li>• Check if there is a problem in the wall outlet by connecting other products.</li> </ul>
The TV turns off suddenly.	<ul style="list-style-type: none"> <li>• Check the power control settings. The power supply may be interrupted.</li> <li>• Check if the Auto sleep feature is activated in the Time settings.</li> <li>• If there is no signal while the TV is on, the TV will turn off automatically after 15 minutes of inactivity.</li> </ul>
When connecting to the PC (HDMI), 'No signal' or 'Invalid Format' is displayed.	<ul style="list-style-type: none"> <li>• Turn the TV off/on using the remote control.</li> <li>• Reconnect the HDMI cable.</li> <li>• Restart the PC with the TV on.</li> </ul>

## ENVIRONMENTAL INFORMATION

(India only)

### WEEE



#### Disposal of your old appliance

1. When this crossed-out wheeled bin symbol is attached to a product it means the product is covered by the e-waste (Management and Handling) Rules, 2011.
2. All electrical and electronic products should be disposed of separately from the municipal waste stream via designated collection facilities appointed by the government or the local authorities.
3. The correct disposal of your old appliance will help prevent potential negative consequences for the environment and human health.
4. For more detailed information about disposal of your old appliance, please contact your city office, waste disposal service or the shop where you purchased the product.
5. This product does not contain any of the hazardous substances as specified in the rule 13 (1) and (2) of the e-waste (Management and Handling) Rules, 2011.

## पर्यावरणीय जानकारी

### WEEE



#### अपने पुराने उपकरण का निपटान

1. जब यह काटे गये पहिये वाले बिन का चिह्न किसी उत्पाद के साथ संलग्न होता है तो इसका अर्थ है उत्पाद ई-अपशिष्ट (प्रबंधन और हथालन) नियम २०११ के अंतर्गत सम्मिलित किया गया है।
2. सभी इलेक्ट्रिकल एवं और इलेक्ट्रॉनिक उत्पादों को सरकार या स्थानीय अधिकारियों द्वारा नियुक्त नगरपालिका अपशिष्ट धारा से अलग प्राधिकृत की गई संग्रह सुविधाओं के माध्यम से निपटाया जाना चाहिए।
3. सही तरीके से अपने पुराने उपकरणों का निपटान वातावरण और मानवीय स्वास्थ्य के लिए संभावित नकारात्मक परिणामों को रोकने में मदद करेगा।
4. अपने पुराने उपकरणों के निपटान के संबंध में और अधिक विसृत जानकारी के लिए, कृपया अपने नगर कार्यालय, अपशिष्ट निपटान सेवा या जहां से आपने उत्पाद खरीदा था, वहां संपर्क करें।
5. इस उत्पाद में ई-अपशिष्ट(प्रबंधन और हथालन) नियम, २०११ के नियम १३ (१) और (२) में निर्देशानुसार कोई भी हानिकारक पदार्थ शामिल नहीं है।

## SPECIFICATIONS

Product specifications may be changed without prior notice due to upgrade of product functions.  
For the power supply and power consumption, refer to the label attached to the product.

		32LN54**	37LN54**	39LN54**
<b>MODELS</b>		32LN5400-TA	37LN5400-TA	39LN5400-TA
		32LN541B-TB	37LN541B-TB	39LN541B-TB
		32LN5420-TC	37LN5420-TC	39LN5420-TC
		32LN542B-TC	37LN542B-TC	39LN542B-TC
		32LN5430-TD	37LN5430-TD	39LN5430-TD
		32LN543B-TD	37LN543B-TD	39LN543B-TD
		32LN5440-TJ	37LN5440-TJ	39LN5440-TJ
		32LN544B-TJ	37LN544B-TJ	39LN544B-TJ
		32LN542Y-TC	37LN542Y-TC	39LN542Y-TC
		32LN542Z-TC	37LN542Z-TC	39LN542Z-TC
		32LN543Y-TD	37LN543Y-TD	39LN543Y-TD
		32LN543Z-TD	37LN543Z-TD	39LN543Z-TD
		32LN544Y-TJ	37LN544Y-TJ	39LN544Y-TJ
		32LN544Z-TJ	37LN544Z-TJ	39LN544Z-TJ
		32LN541B-TC	37LN541B-TC	39LN541B-TC
		32LN541Y-TC	37LN541Y-TC	39LN541Y-TC
		32LN540B-TA	37LN540B-TA	39LN540B-TA
		32LN5460-TA	37LN5460-TA	39LN5460-TA
		32LN546B-TA	37LN546B-TA	39LN546B-TA
		32LN5460-TM	37LN5460-TM	39LN5460-TM
32LN546B-TM	37LN546B-TM	39LN546B-TM		
32LN546Y-TM	37LN546Y-TM	39LN546Y-TM		
32LN546Z-TM	37LN546Z-TM	39LN546Z-TM		
Dimensions (W x H x D)	With stand (mm)	738.0 x 497.0 x 207.0	849.0 x 561.0 x 236.0	894.0 x 587.0 x 236.0
	Without stand(mm)	738.0 x 449.0 x 79.0	849.0 x 512.0 x 79.0	894.0 x 537.0 x 79.0
Weight	With stand (kg)	7.0	9.1	9.7
	Without stand (kg)	6.4	8.0	8.6
Power requirement		AC 100-240 V~ 50 / 60 Hz	AC 100-240 V~ 50 / 60 Hz	AC 100-240 V~ 50 / 60 Hz

<b>MODELS</b>	<b>42LN54**</b>				<b>47LN54**</b>				<b>50LN54**</b>			
	42LN5400-TA				47LN5400-TA				50LN5400-TA			
	42LN541B-TB				47LN541B-TB				50LN541B-TB			
	42LN5420-TC				47LN5420-TC				50LN5420-TC			
	42LN542B-TC				47LN542B-TC				50LN542B-TC			
	42LN5430-TD				47LN5430-TD				50LN5430-TD			
	42LN543B-TD				47LN543B-TD				50LN543B-TD			
	42LN5440-TJ				47LN5440-TJ				50LN5440-TJ			
	42LN544B-TJ				47LN544B-TJ				50LN544B-TJ			
	42LN542Y-TC				47LN542Y-TC				50LN542Y-TC			
	42LN542Z-TC				47LN542Z-TC				50LN542Z-TC			
	42LN543Y-TD				47LN543Y-TD				50LN543Y-TD			
	42LN543Z-TD				47LN543Z-TD				50LN543Z-TD			
	42LN544Y-TJ				47LN544Y-TJ				50LN544Y-TJ			
	42LN544Z-TJ				47LN544Z-TJ				50LN544Z-TJ			
	42LN541B-TC				47LN541B-TC				50LN541B-TC			
	42LN541Y-TC				47LN541Y-TC				50LN541Y-TC			
	42LN540B-TA				47LN540B-TA				50LN540B-TA			
	42LN5460-TA				47LN5460-TA				50LN5460-TA			
	42LN546B-TA				47LN546B-TA				50LN546B-TA			
	42LN5460-TM				47LN5460-TM				50LN5460-TM			
	42LN546B-TM				47LN546B-TM				50LN546B-TM			
42LN546Y-TM				47LN546Y-TM				50LN546Y-TM				
42LN546Z-TM				47LN546Z-TM				50LN546Z-TM				
Dimensions (W x H x D)	With stand (mm)	968.0 x 629.0 x 236.0			1080.0 x 694.0 x 264.0			1136.0 x 727.0 x 264.0				
	Without stand(mm)	968.0 x 579.0 x 79.0			1080.0 x 642.0 x 80.5			1136.0 x 673.0 x 82.1				
Weight	With stand (kg)	10.7			14.5			15.6				
	Without stand (kg)	9.6			13.1			14.2				
Power requirement		AC 100-240 V~ 50 / 60 Hz			AC 100-240 V~ 50 / 60 Hz			AC 100-240 V~ 50 / 60 Hz				
<b>MODELS</b>	<b>55LN54**</b>				<b>60LN54**</b>				<b>32LN565*</b>			
	55LN5400-TA				60LN5400-TA				32LN5650-TA			
	55LN541B-TB				60LN541B-TB							
	55LN5420-TC				60LN5420-TC							
	55LN542B-TC				60LN542B-TC							
	55LN5430-TD				60LN5430-TD							
	55LN543B-TD				60LN543B-TD							
	55LN5440-TJ				60LN5440-TJ							
	55LN544B-TJ				60LN544B-TJ							
	55LN542Y-TC				60LN542Y-TC							
	55LN542Z-TC				60LN542Z-TC							
	55LN543Y-TD				60LN543Y-TD							
	55LN543Z-TD				60LN543Z-TD							
	55LN544Y-TJ				60LN544Y-TJ							
	55LN544Z-TJ				60LN544Z-TJ							
	55LN541B-TC				60LN541B-TC							
	55LN541Y-TC				60LN541Y-TC							
	55LN540B-TA				60LN540B-TA							
	55LN5460-TA				60LN5460-TA							
	55LN546B-TA				60LN546B-TA							
	55LN5460-TM				60LN5460-TM							
	55LN546B-TM				60LN546B-TM							
55LN546Y-TM				60LN546Y-TM								
55LN546Z-TM				60LN546Z-TM								
Dimensions (W x H x D)	With stand (mm)	1250.0 x 790.0 x 297.0			1359.0 x 852.0 x 297.0			743.0 x 499.0 x 206.0				
	Without stand(mm)	1250.0 x 737.0 x 79.1			1359.0 x 799.0 x 67.2			743.0 x 451.0 x 96.0				
Weight	With stand (kg)	21.2			26.3			8.9				
	Without stand (kg)	19.1			24.2			8.3				
Power requirement		AC 100-240 V~ 50 / 60 Hz			AC 100-240 V~ 50 / 60 Hz			AC 100-240 V~ 50 / 60 Hz				

MODELS		32LA61**	42LA61**	50LA61**
			32LA6130-TB 32LA6150-TC 32LA615B-TC 32LA613B-TB 32LA615Y-TC 32LA613Y-TB 32LA6160-TD 32LA616B-TD 32LA6170-TE 32LA617B-TE 32LA616Y-TD	42LA6130-TB 42LA6150-TC 42LA615B-TC 42LA613B-TB 42LA615Y-TC 42LA613Y-TB 42LA6160-TD 42LA616B-TD 42LA6170-TE 42LA617B-TE 42LA616Y-TD
Dimensions (W x H x D)	With stand (mm)	733.0 x 499.0 x 242.0	964.0 x 631.0 x 294.0	1131.0 x 725.0 x 327.0
	Without stand(mm)	733.0 x 444.0 x 78.0	964.0 x 573.0 x 78.0	1131.0 x 667.0 x 80.9
Weight	With stand (kg)	7.6	11.8	17.0
	Without stand (kg)	6.4	10.0	14.5
Power requirement		AC 100-240 V~ 50 / 60 Hz	AC 100-240 V~ 50 / 60 Hz	AC 100-240 V~ 50 / 60 Hz

Environment condition	Operating Temperature	0 °C to 40 °C
	Operating Humidity	Less than 80 %
	Storage Temperature	-20 °C to 60 °C
	Storage Humidity	Less than 85 %

		Digital TV	Analogue TV
New Zealand, Singapore	Television System	DVB-T	PAL/SECAM-B/G/D/K, PAL-I
	Programme Coverage	UHF 21 to 69	BG : VHF/UHF 1 to 69, CATV 01 to 47 I : VHF/UHF 1 to 69, CATV 01 to 47 DK : VHF/UHF 1 to 69, CATV 01 to 47
Australia	Television System	DVB-T	PAL B/B
	Programme Coverage	VHF 06 to 12, UHF 27 to 69	B/B : VHF/UHF 0 to 75, CATV : 2 to 44
Indonesia, Israel, Myanmar, Sri Lanka	Television System	DVB-T	PAL/SECAM-B/G/D/K, PAL-I, NTSC-M
	Programme Coverage	UHF 21 to 69	BG : VHF/UHF 1 to 69, CATV 01 to 47 I : VHF/UHF 1 to 69, CATV 01 to 47 DK : VHF/UHF 1 to 69, CATV 01 to 47 M : VHF/UHF 2 to 78, CATV 01 to 71
Vietnam, Malaysia	Television System	DVB-T	PAL/SECAM-B/G/D/K, PAL-I, NTSC-M
	Programme Coverage	VHF 6 to 12, UHF 21 to 69	BG : VHF/UHF 1 to 69, CATV 01 to 47 I : VHF/UHF 1 to 69, CATV 01 to 47 DK : VHF/UHF 1 to 69, CATV 01 to 47 M : VHF/UHF 2 to 78, CATV 01 to 71
Iran, Algeria, Tunisia, Digital model	Television System	DVB-T	PAL/SECAM-B/G/D/K, PAL-I, NTSC-M
	Programme Coverage	VHF 5 to 12, UHF 21 to 69	BG : VHF/UHF 1 to 69, CATV 01 to 47 I : VHF/UHF 1 to 69, CATV 01 to 47 DK : VHF/UHF 1 to 69, CATV 01 to 47 M : VHF/UHF 2 to 78, CATV 01 to 71
Analogue model, India, Thailand, South Africa, --	Television System	-	PAL/SECAM-B/G/D/K, PAL-I, NTSC-M
	Programme Coverage	-	BG : VHF/UHF 1 to 69, CATV 01 to 47 I : VHF/UHF 1 to 69, CATV 01 to 47 DK : VHF/UHF 1 to 69, CATV 01 to 47 M : VHF/UHF 2 to 78, CATV 01 to 71
	External Antenna Impedance	75 Ω	75 Ω



**HDMI-DTV supported mode**

Resolution	Horizontal Frequency (kHz)	Vertical Frequency (Hz)
<b>720x480</b>	31.469	59.94
	31.5	60
<b>720x576</b>	31.25	50
<b>1280x720</b>	37.5	50
	44.96	59.94
	45	60
<b>1920x1080</b>	33.72	59.94
	33.75	60
	28.125	50
	26.97	23.97
	27	24
	33.716	29.976
	33.75	30.00
	56.25	50
	67.43	59.94
	67.5	60

**Component port connecting information**

Component ports on the TV	Y	P <sub>B</sub>	P <sub>R</sub>
---------------------------	---	----------------	----------------

Video output ports on DVD player	Y	P <sub>B</sub>	P <sub>R</sub>
	Y	B-Y	R-Y
	Y	Cb	Cr
	Y	Pb	Pr

Signal	Component
<b>480i/576i</b>	O
<b>480p/576p</b>	O
<b>720p/1080i</b>	O
<b>1080p</b>	O (50 Hz / 60 Hz only)

**HDMI-PC supported mode**

Resolution	Horizontal Frequency (kHz)	Vertical Frequency (Hz)
<b>640x350</b>	31.468	70.09
<b>720x400</b>	31.469	70.08
<b>640x480</b>	31.469	59.94
<b>800x600</b>	37.879	60.31
<b>1024x768</b>	48.363	60.00
<b>1152x864</b>	54.348	60.053
<b>1360x768</b>	47.712	60.015
<b>1280x1024</b>	63.981	60.020
<b>1920x1080</b>	67.50	60.00

(Except for 32LN565\*, 32/37LN541B, 32LN542B, 32/37LN543B, 32LN544B, 32LN542Z, 32LN543Z, 32LN544Z, 37LN541Y, 37LN543Y, 32LN540B, 32LN546B, 32LA613B, 32LA613Y, 32LA616B, 32LA617B, 32LA616Y )

## 3D supported mode (Only 3D model)

- Video, which is input as below media contents is switched into the 3D screen automatically.
- The method for 3D digital broadcast may differ depending on the signal environment. If video is not switched automatically into 3D, manually convert the settings to view 3D images.

Input	Signal	Resolution	Horizontal Frequency (kHz)	Vertical Frequency (Hz)	Playable 3D video format
HDMI	720p	1280X720	37.5	50	Side by Side(half), Top and Bottom
			45	60	
			75	50	Frame packing
			89.9 / 90	59.94 / 60	
	1080i	1920X1080	28.125	50	Side by Side(half), Top and Bottom
			33.7	60	
	1080p	1920X1080	27	24	Side by Side(half), Top and Bottom
			33.7	30	
			53.95 / 54	23.98 / 24	Frame packing
			56.3	50	Side by Side(half), Top and Bottom
67.5	60				
DTV	720p	1280X720	37.5	50	Side by Side, Top and Bottom
	1080i	1920X1080	28.125	50	
USB	1080p	1920X1080	33.75	30	Side by Side, Top and Bottom, MPO(Photo)

## LICENSES

Supported licenses may differ by model. For more information about licenses, visit [www.lg.com](http://www.lg.com).



Manufactured under license from Dolby Laboratories. "Dolby" and the double-D symbol are trademarks of Dolby Laboratories.



The terms HDMI and HDMI High-Definition Multimedia Interface, and the HDMI logo are trademarks or registered trademarks of HDMI Licensing LLC in the United States and other countries.



**ABOUT DIVX VIDEO:** DivX® is a digital video format created by DivX, LLC, a subsidiary of Rovi Corporation. This is an official DivX Certified® device that plays DivX video. Visit [divx.com](http://divx.com) for more information and software tools to convert your files into DivX video.

**ABOUT DIVX VIDEO-ON-DEMAND:** This DivX Certified® device must be registered in order to play purchased DivX Video-on-Demand (VOD) movies. To obtain your registration code, locate the DivX VOD section in your device setup menu. Go to [vod.divx.com](http://vod.divx.com) for more information on how to complete your registration.

"DivX Certified® to play DivX® video up to HD 1080p, including premium content."

"DivX®, DivX Certified® and associated logos are trademarks of Rovi Corporation or its subsidiaries and are used under license."

"Covered by one or more of the following U.S. patents :  
7,295,673; 7,460,668; 7,515,710; 7,519,274"



Manufactured under license under U.S. Patent Nos: 5,956,674; 5,974,380; 6,487,535 & other U.S. and worldwide patents issued & pending. DTS, the Symbol & DTS and the Symbol together are registered trademarks & DTS 2.0+Digital Out is a trademark of DTS, Inc. Product includes software. © DTS, Inc. All Rights Reserved.



Manufactured under license under U.S. Patent Nos: 5,956,674; 5,974,380; 6,487,535 & other U.S. and worldwide patents issued & pending. DTS, the Symbol, & DTS and the Symbol together are registered trademarks & DTS 2.0 Channel is a trademark of DTS, Inc. Product includes software. © DTS, Inc. All Rights Reserved.

## OPEN SOURCE SOFTWARE NOTICE

To obtain the source code under GPL, LGPL, MPL and other open source licenses, that is contained in this product, please visit <http://opensource.lge.com>.

In addition to the source code, all referred license terms, warranty disclaimers and copyright notices are available for download.

LG Electronics will also provide open source code to you on CD-ROM for a charge covering the cost of performing such distribution (such as the cost of media, shipping and handling) upon email request to [opensource@lge.com](mailto:opensource@lge.com). This offer is valid for three (3) years from the date on which you purchased the product.

## EXTERNAL CONTROL DEVICE SETUP

To obtain the external control device setup information, please visit [www.lg.com](http://www.lg.com)



Record the model number and serial number of the TV.  
Refer to the label on the back cover and quote this information to your dealer when requiring any service.

MODEL \_\_\_\_\_

SERIAL \_\_\_\_\_

(Only DTV)

**DVB**<sup>®</sup>  
Digital Video  
Broadcasting



**LG**

Life's Good

OWNER'S MANUAL

# EXTERNAL CONTROL DEVICE SETUP

Please read this manual carefully before operating the set and retain it for future reference.

# KEY CODES

- This feature is not available for all models.

Code (Hexa)	Function	Note	Code (Hexa)	Function	Note
00	CH +, PR +	R/C Button	45	Q.Menu	R/C Button
01	CH -, PR -	R/C Button	4C	List, - (ATSC Only)	R/C Button
02	Volume +	R/C Button	53	List	R/C Button
03	Volume -	R/C Button	5B	Exit	R/C Button
06	> (Arrow Key / Right Key)	R/C Button	61	Blue	R/C Button
07	< (Arrow Key / Left Key)	R/C Button	63	Yellow	R/C Button
08	Power	R/C Button	71	Green	R/C Button
09	Mute	R/C Button	72	Red	R/C Button
0B	Input	R/C Button	79	Ratio / Aspect Ratio	R/C Button
0E	SLEEP	R/C Button	91	AD (Audio Description)	R/C Button
0F	TV, TV/RAD	R/C Button	7A	User Guide	R/C Button
10 - 19	* Number Key 0 - 9	R/C Button	7C	Smart/ Home	R/C Button
1A	Q.View / Flashback	R/C Button	7E	Simplink	R/C Button
1E	FAV (Favorite Channel)	R/C Button	8E	▶▶ (Forward)	R/C Button
20	Text (Teletext)	R/C Button	8F	◀◀ (Rewind)	R/C Button
21	T. Opt (Teletext Option)	R/C Button	AA	Info	R/C Button
28	Return (BACK)	R/C Button	AB	Program Guide	R/C Button
30	AV (Audio/ Video) Mode	R/C Button	B0	▶ (Play)	R/C Button
39	Caption/Subtitle	R/C Button	B1	■ (Stop/ Live TV)	R/C Button
40	∧ (Arrow Key/ Cursor Up)	R/C Button	BA	(Freeze/Slow Play/Pause)	R/C Button
41	∨ (Arrow Key/ Cursor Down)	R/C Button	BD	● (REC)	R/C Button
42	My Apps	R/C Button	DC	3D	R/C Button
43	Menu / Settings	R/C Button	9F	App/ *	R/C Button
44	OK / Enter	R/C Button			

\* Key code 4C (0x4C) is available on ATSC/ISDB models which use major/minor channel.  
(For South Korea, Japan, North America, Latin America except Colombia models)

# EXTERNAL CONTROL DEVICE SETUP

- Image shown may differ from your TV.

Connect the USB to Serial converter/RS-232C input jack to an external control device (such as a computer or an A/V control system) to control the product's functions externally.

Note: There are several ways to connect TV based on model's support port.

- \* Please be advised that not all models support these connectivity.
- \* Cable is not provided.

## USB to Serial converter with USB Cable

USB Type

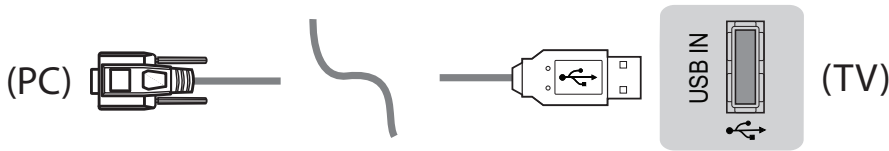

- LGTV supports PL2303 chip-based (Vendor ID : 0x0557, Product ID : 0x2008) USB to serial converter which is not made nor provided by LG.
- It can be purchased from computer stores that carry accessories for IT support professionals.

## RS-232C with RS-232C Cable (Legacy)

Phone jack Type

- You need to purchase the phone-jack to RS-232 cable required for the connection between the PC and the TV, which is specified in the manual.
- \* For other models, connect to the USB port.

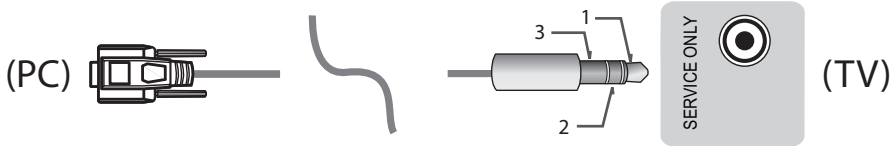

- This connection can only be used for the following models: 55/47/39LN5450-UA, 55/50/47/42LN5400-UA, 42/39/32LN5300-UA, and 37/32LN530B-UA.

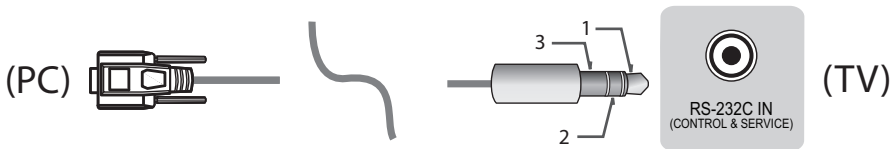

- This connection can only be used for the following models: 60PN6550-UA, 50/60PN6500-UA, 50/60PN5300-UF, and 42/50PN4500-UA.

### Customer Computer

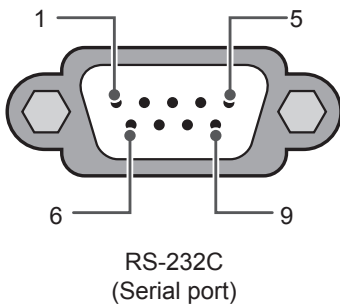

### RS-232C configurations

3-Wire Configurations(Not standard)

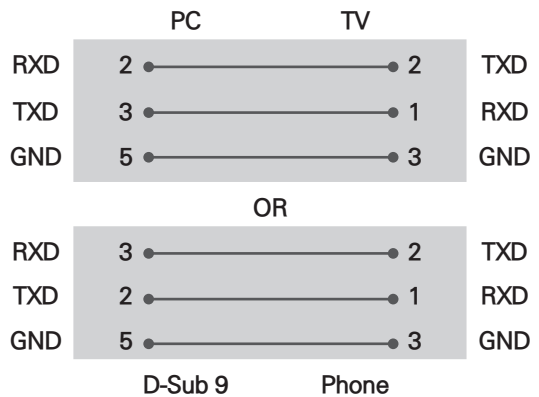

### Set ID

For Set ID number, see "Real Data Mapping" on p. 6

1. Press **SETTINGS** to access the main menus.
2. Press the Navigation buttons to scroll to **OPTION** and press **OK**.
3. Press the Navigation buttons to scroll to **SET ID** and press **OK**.
4. Scroll left or right to select a set ID number and select **CLOSE**. The adjustment range is 1-99.
5. When you are finished, press **EXIT**.



## Communication Parameters

- Baud rate : 9600 bps (UART)
- Data length : 8 bits
- Parity : None
- Stop bit : 1 bit
- Communication code : ASCII code
- Use a crossed (reverse) cable.

## Command reference list

(Depending on model)

	COMMAND1	COMMAND2	DATA (Hexadecimal)		COMMAND1	COMMAND2	DATA (Hexadecimal)
01. Power off	k	a	00	13. Balance	k	t	00 to 64
02. Aspect Ratio	k	c	(See p.7)	14. Color (Colour) Temperature	x	u	00 to 64
03. Screen Mute	k	d	(See p.7)	15. ISM Method (Only Plasma TV)	j	p	(See p.9)
04. Volume Mute	k	e	00 to 01	16. Energy Saving	j	q	00 to 05
05. Volume Control	k	f	00 to 64	17. Tune Command	m	a	(See p.9)
06. Contrast	k	g	00 to 64	18. Channel (Programme) Add/Del(Skip)	m	b	00 to 01
07. Brightness	k	h	00 to 64	19. Key	m	c	Key Codes
08. Color/ Colour	k	i	00 to 64	20. Control Back Light, Control Panel Light	m	g	00 to 64
09. Tint	k	j	00 to 64	21. Input select (Main)	x	b	(See p.11)
10. Sharpness	k	k	00 to 32	22. 3D (Only 3D models)	x	t	(See p.12)
11. OSD Select	k	l	00 to 01	23. Extended 3D (Only 3D models)	x	v	(See p.12)
12. Remote Control Lock Mode	k	m	00 to 01				

\* Note: During USB operations such as DivX or EMF, all commands except Power(ka) and Key(mc) are not executed and treated as NG.

## Transmission / Receiving Protocol

### Transmission

[Command1][Command2][ ][Set ID][ ][Data][Cr]

[Command 1] : First command to control the TV. (j, k, m or x)

[Command 2] : Second command to control the TV.

[Set ID] : You can adjust the [Set ID] to choose desired monitor ID number in option menu.

Adjustment range in TV is 1 to 99. If [Set ID] value is selected to '0', every connected set can be controlled.

\* [Set ID] is indicated as decimal (1 to 99) on menu and as Hexadecimal (0x00 to 0x63) on transmission/receiving protocol.

[DATA] : To transmit command data (hexadecimal). Transmit 'FF' data to read status of command.

[Cr] : Carriage Return - ASCII code '0x0D'

[ ] : Space – ASCII code '0x20'

### OK Acknowledgement

[Command2][ ][Set ID][ ][OK][Data][x]

\* The set transmits ACK (acknowledgement) based on this format when receiving normal data. At this time, if the data is data read mode, it indicates present status data. If the data is data write mode, it returns the data of the PC computer.

### Error Acknowledgement

[Command2][ ][Set ID][ ][NG][Data][x]

\* The set transmits ACK (acknowledgement) based on this format when receiving abnormal data from non-viable functions or communication errors.

Data 00: Illegal Code

### Real data mapping (Hexadecimal → Decimal)

\* When you enter the [data] in hexadecimal, refer to following conversion table.

\* Channel Tune (ma) Command uses two-byte hexadecimal value([data]) to select channel number.

00 : Step 0	32 : Step 50 (Set ID 50)	FE : Step 254
01 : Step 1 (Set ID 1)	33 : Step 51 (Set ID 51)	FF : Step 255
...	...	...
0A : Step 10 (Set ID 10)	63 : Step 99 (Set ID 99)	01 00 : Step 256
...	...	...
0F : Step 15 (Set ID 15)	C7 : Step 199	27 0E : Step 9998
10 : Step 16 (Set ID 16)	C8 : Step 200	27 0F : Step 9999
...	...	...

\* Commands may work differently depending on model and signal.

#### 01. Power (Command: k a)

- ▶ To control Power Off of the set.

Transmission [k][a][ ][Set ID][ ][Data][Cr]

Data 00 : Power Off

Ack [a][ ][Set ID][ ][OK/NG][Data][x]

- ▶ To Show Power On. (Works TV is On Only)

Transmission [k][a][ ][Set ID][ ][FF][Cr]

Ack [a][ ][Set ID][ ][OK][01][x]

\* Similarly, if other functions transmit 'FF' data based on this format, Acknowledgement feedback presents status about each function.

#### 02. Aspect Ratio (Command: k c) (Main Picture Size)

- ▶ To adjust the screen format. (Main picture format)  
You can also adjust the screen format using the Aspect Ratio in the Q.MENU. or PICTURE menu.

Transmission [k][c][ ][Set ID][ ][Data][Cr]

Data 01 : Normal screen (4:3)	07 : 14:9 (Europe, Colombia, Mid-East, Asia except South Korea and Japan)
02 : Wide screen (16:9)	09 : * Just Scan
04 : Zoom	0B : Full Wide (Europe, Colombia, Mid-east, Asia except South Korea and Japan)
05 : Zoom 2 (Latin America except Colombia Only)	10 to 1F : Cinema Zoom 1 to 16
06 : Set by Program/Original	

Ack [c][ ][Set ID][ ][OK/NG][Data][x]

- \* Using the PC input, you select either 16:9 or 4:3 screen aspect ratio.
- \* In DTV/HDMI/Component mode (high-definition), Just Scan is available.
- \* Full wide mode may work differently based on model and is supported for DTV fully, and ATV, AV partially.

#### 03. Screen Mute (Command: k d)

- ▶ To select screen mute on/off.

Transmission [k][d][ ][Set ID][ ][Data][Cr]

Data 00 : Screen mute off (Picture on)  
Video mute off

01 : Screen mute on (Picture off)  
10 : Video mute on

Ack [d][ ][Set ID][ ][OK/NG][Data][x]

\* In case of video mute on only, TV will display On Screen Display(OSD). But, in case of Screen mute on, TV will not display OSD.

#### 04. Volume Mute (Command: k e)

- ▶ To control volume mute on/off.  
You can also adjust mute using the MUTE button on remote control.

Transmission [k][e][ ][Set ID][ ][Data][Cr]

Data 00 : Volume mute on (Volume off)  
01 : Volume mute off (Volume on)

Ack [e][ ][Set ID][ ][OK/NG][Data][x]

#### 05. Volume Control (Command: k f)

- ▶ To adjust volume.  
You can also adjust volume with the volume buttons on remote control.

Transmission [k][f][ ][Set ID][ ][Data][Cr]

Data Min : 00 to Max : 64

Ack [f][ ][Set ID][ ][OK/NG][Data][x]

#### 06. Contrast (Command: k g)

- ▶ To adjust screen contrast.  
You can also adjust contrast in the PICTURE menu.

Transmission [k][g][ ][Set ID][ ][Data][Cr]

Data Min : 00 to Max : 64

Ack [g][ ][Set ID][ ][OK/NG][Data][x]

#### 07. Brightness (Command: k h)

- ▶ To adjust screen brightness.  
You can also adjust brightness in the PICTURE menu.

Transmission [k][h][ ][Set ID][ ][Data][Cr]

Data Min : 00 to Max : 64

Ack [h][ ][Set ID][ ][OK/NG][Data][x]

#### 08. Color/Colour (Command: k i)

- ▶ To adjust the screen Color(Colour).  
You can also adjust colour in the PICTURE menu.

Transmission [k][i][ ][Set ID][ ][Data][Cr]

Data Min : 00 to Max : 64

Ack [i][ ][Set ID][ ][OK/NG][Data][x]

## 09. Tint (Command: k j)

- ▶ To adjust the screen tint.  
You can also adjust tint in the PICTURE menu.

Transmission [k][j][ ][Set ID][ ][Data][Cr]

Data Red : 00 to Green : 64

Ack [j][ ][Set ID][ ][OK/NG][Data][x]

## 10. Sharpness (Command: k k)

- ▶ To adjust the screen sharpness.  
You can also adjust sharpness in the PICTURE menu.

Transmission [k][k][ ][Set ID][ ][Data][Cr]

Data Min : 00 to Max : 32

Ack [k][ ][Set ID][ ][OK/NG][Data][x]

## 11. OSD Select (Command: k l)

- ▶ To select OSD (On Screen Display) on/off when controlling remotely.

Transmission [k][l][ ][Set ID][ ][Data][Cr]

Data 01 : OSD off            01 : OSD on

Ack [l][ ][Set ID][ ][OK/NG][Data][x]

## 12. Remote control lock mode (Command: k m)

- ▶ To lock the front panel controls on the monitor and remote control.

Transmission [k][m][ ][Set ID][ ][Data][Cr]

Data 01 : Lock off            01 : Lock on

Ack [m][ ][Set ID][ ][OK/NG][Data][x]

- \* If you are not using the remote control, use this mode.  
When main power is off & on (plug-off and plug-in, after 20 - 30 seconds), external control lock is released.
- \* In the standby mode (DC off by off timer or 'ka', 'mc' command), and if key lock is on, TV will not turn on by power on key of IR & Local Key.

## 13. Balance (Command: k t)

- ▶ To adjust balance.  
You can also adjust balance in the AUDIO menu.

Transmission [k][t][ ][Set ID][ ][Data][Cr]

Data Min : 00 to Max : 64

Ack [t][ ][Set ID][ ][OK/NG][Data][x]

## 14. Color(Colour) Temperature (Command: x u)

- ▶ To adjust colour temperature. You can also adjust Color(Colour) Temperature in the PICTURE menu.

Transmission [x][u][ ][Set ID][ ][Data][Cr]

Data Min : 00 to Max : 64

Ack [u][ ][Set ID][ ][OK/NG][Data][x]

## 15. ISM Method (Command: j p) (Only Plasma TV)

- ▶ To control the ISM method. You can also adjust ISM Method in OPTION menu.

Transmission [j][p][ ][Set ID][ ][Data][Cr]

Data Min : 02: Orbiter

08: Normal

20: Color(Colour) Wash

Ack [p][ ][Set ID][ ][OK/NG][Data][x]

## 16. Energy Saving (Command: j q)

- ▶ To reduce the power consumption of the TV. You can also adjust Energy Saving in PICTURE menu.

Transmission [j][q][ ][Set ID][ ][Data][Cr]

Data

00 : Off

01 : Minimum

02 : Medium

03 : Maximum

04 : Auto

05 : Screen off

- \* (Depending on model)

Ack [q][ ][Set ID][ ][OK/NG][Data][x]

## 17. Tune Command (Command: m a)

- \* This command may work differently depending on model and signal.
- For Europe, Mid-East, Colombia, Asia except South Korea and Japan Model
- ▶ Select channel to following physical number.

Transmission [m][a][ ][Set ID][ ][Data 00][ ][Data 01][ ][Data 02][Cr]

- \* Analogue Terrestrial/Cable

[Data 00][Data 01] Channel Data

Data 00 : High byte channel data

Data 01 : Low byte channel data  
- 00 00 ~ 00 C7 (Decimal : 0 ~ 199)

Data 02 : Input Source (Analogue)

- 00 : Terrestrial TV (ATV)

- 80 : Cable TV (CATV)

## \* Digital Terrestrial/Cable/Satellite

[Data 00][Data 01]: Channel Data

Data 00 : High Channel data

Data 01 : Low Channel data

- 00 00 ~ 27 0F (Decimal: 0 ~ 9999)

Data 02 : Input Source (Digital)

- 10 : Terrestrial TV (DTV)

- 20 : Terrestrial Radio (Radio)

- 40 : Satellite TV (SDTV)

- 50 : Satellite Radio (S-Radio)

- 90 : Cable TV (CADTV)

- a0 : Cable Radio (CA-Radio)

## \* Tune Command Examples:

## 1. Tune to the analogue terrestrial (PAL) Channel 10.

Set ID = All = 00

Data 00 &amp; 01 = Channel Data is 10 = 00 0a

Data 02 = Analogue Terrestrial TV = 00

Result = **ma 00 00 0a 00**

## 2. Tune to the digital terrestrial (DVB-T) Channel 01.

Set ID = All = 00

Data 00 &amp; 01 = Channel Data is 1 = 00 01

Data 02 = Digital Terrestrial TV = 10

Result = **ma 00 00 01 10**

## 3. Tune to the satellite (DVB-S) Channel 1000.

Set ID = All = 00

Data 00 &amp; 01 = Channel Data is 1000 = 03 E8

Data 02 = Digital Satellite TV = 40

Result = **ma 00 03 E8 40**

Ack [a] [ ][Set ID][ ][OK][Data 00][Data 01][Data 02][x]

[a] [ ][Set ID][ ][NG][Data 00][x]

- For South Korea, North/Latin America except Colombia Model

- ▶ To tune channel to following physical/major/minor number.

Transmission [m][a] [ ][0] [ ][Data00][ ][Data01]

[ ][Data02][ ][Data03][ ][Data04][ ][Data05][Cr]

Digital channels have a Physical, Major, and Minor channel number. The Physical number is the actual digital channel number, the Major is the number that the channel should be mapped to, and the Minor is the sub-channel. Since the ATSC tuner automatically maps the channel from the Major / Minor number, the Physical number is not required when sending a command in Digital.

## \* Analogue Terrestrial/Cable

Data 00 : Physical Channel Number

- Terrestrial (ATV) : 02~45 (Decimal: 2 ~ 69)

- Cable (CATV) : 01, 0E~7D (Decimal : 1, 14~125)

[Data 01 ~ 04]: Major/Minor Channel Number

Data 01 &amp; 02: xx (Don't care)

Data 03 &amp; 04: xx (Don't care)

Data 05: Input Source (Analogue)

- 00 : Terrestrial TV (ATV)

- 01 : Cable TV (CATV)

## \* Digital Terrestrial/Cable

Data 00 : xx (Don't care)

[Data 01][Data 02]: Major Channel Number

Data 01 : High byte Channel Data

Data 02 : Low byte Channel Data

- 00 01 ~ 27 0F (Decimal: 1 ~ 9999)

[Data 03][Data 04]: Minor Channel Number

Data 03 : High byte Channel Data

Data 04 : Low byte Channel Data

Data 05 : Input Source (Digital)

- 02 : Terrestrial TV (DTV) – Use Physical Channel Number

- 06 : Cable TV (CADTV) – Use Physical Channel Number

- 22 : Terrestrial TV (DTV) – Don't Use Physical Channel Number

- 26 : Cable TV (CADTV) - Don't Use Physical Channel Number

- 46 : Cable TV (CADTV) – Use Major Channel Number Only (One Part Channel)

Two bytes are available for each major and minor channel data, but usually the low byte is used alone (high byte is 0).

## \* Tune Command Examples:

## 1. Tune to the analogue cable (NTSC) channel 35.

Set ID = All = 00

Data 00 = Channel Data is 35 = 23

Data 01 &amp; 02 = No Major = 00 00

Data 03 &amp; 04 = No Minor = 00 00

Data 05 = Analogue Cable TV = 01

Total = **ma 00 23 00 00 00 01**

## 2. Tune to the digital terrestrial (ATSC) channel 30-3.

Set ID = All = 00

Data 00 = Don't know Physical = 00

Data 01 &amp; 02 = Major is 30 = 00 1E

Data 03 &amp; 04 = Minor is 3 = 00 03

Data 05 = Digital Terrestrial TV = 22

Total = **ma 00 00 00 1E 00 03 22**

Ack [a] [ ][Set ID][ ][OK][Data 00][Data 01]

[Data 02][Data 03][Data 04][Data 05]

[x][a] [ ][Set ID][ ][NG][Data 00][x]

- For Japan Model

- ▶ To tune channel to following physical/major/minor number.

Transmission [m][a] [ ][0] [ ][Data00][ ][Data01]

[ ][Data02][ ][Data03][ ][Data04][ ][Data05][Cr]

## \* Digital Terrestrial/Satellite

Data 00: xx (Don't care)

[Data 01][Data 02]: Major Channel Number

Data 01: High byte Channel Data

Data 02: Low byte Channel Data

- 00 01 ~ 27 0F (Decimal: 1 ~ 9999)

[Data 03][Data 04]: Minor/Branch Channel Number

(Don't care in Satellite)

Data 03: High byte Channel Data

Data 04: Low byte Channel Data

Data 05 : Input Source (Digital/Satellite for Japan)

- 02 : Terrestrial TV (DTV)

- 07 : BS (Broadcasting Satellite)

- 08 : CS1 (Communication Satellite 1)

- 09 : CS2 (Communication Satellite 2)

\* Tune Command Examples:

1 Tune to the digital terrestrial (ISDB-T) channel 17-1.

Set ID = All = 00

Data 00 = Don't know Physical = 00

Data 01 & 02 = Major is 17 = 00 11

Data 03 & 04 = Minor/Branch is 1 = 00 01

Data 05 = Digital Terrestrial TV = 02

Total = **ma 00 00 00 11 00 01 02**

2. Tune to the BS (ISDB-BS) channel 30.

Set ID = All = 00

Data 00 = Don't know Physical = 00

Data 01 & 02 = Major is 30 = 00 1E

Data 03 & 04 = Don't Care = 00 00

Data 05 = Digital BS TV = 07

Total = **ma 00 00 00 1E 00 00 07**

\* This feature is varied based on the model.

Ack [a][ ][Set ID][ ][OK][Data 00][Data 01]

[Data 02][Data 03][Data 04][Data 05]

[x][a][ ][Set ID][ ][NG][Data 00][x]

18. Channel(Programme) Add/Del(Skip)

(Command: m b)

► To skip current channel(programme) for next time.

Transmission [m][b][ ][Set ID][ ][Data][Cr]

Data 00 : Del(ATSC,ISDB)/Skip(DVB) 01 : Add

Ack [b][ ][Set ID][ ][OK/NG][Data][x]

\* Set the saved channel status to del(ATSC, ISDB)/skip(DVB) or add.

19. Key (Command: m c)

► To send IR remote key code.

Transmission [m][c][ ][Set ID][ ][Data][Cr]

Data Key code - See p.2.

Ack [c][ ][Set ID][ ][OK/NG][Data][x]

20. Control Back Light (Command: m g)

• For LCD TV / LED TV

► To control the back light.

Transmission [m][g][ ][Set ID][ ][Data][Cr]

Data Min : 00 to Max : 64

Ack [g][ ][Set ID][ ][OK/NG][Data][x]

Control Panel Light (Command: m g)

• For Plasma TV

► To control the panel light.

Transmission [m][g][ ][Set ID][ ][Data][Cr]

Data Min : 00 to Max : 64

Ack [g][ ][Set ID][ ][OK/NG][Data][x]

21. Input select (Command: x b)

(Main Picture Input)

► To select input source for main picture.

Transmission [x][b][ ][Set ID][ ][Data][Cr]

Data

00 : DTV 01 : CADTV

02 : Satellite DTV 10 : ATV

ISDB-BS (Japan)

03 : ISDB-CS1 (Japan)

04 : ISDB-CS2 (Japan)

11 : CATV

20 : AV or AV1

21 : AV2

40 : Component1

41 : Component2

90 : HDMI1

91 : HDMI2

92 : HDMI3

93 : HDMI4

Ack [b][ ][Set ID][ ][OK/NG][Data][x]

\* This function depends on model and signal.

## 22. 3D(Command: x t) (only 3D models)

(Depending on model)

► To change 3D mode for TV.

```
Transmission [x][t][ ][Set ID][ ][Data 00][ ][Data 01]
[ ][Data 02][ ][Data 03][Cr]
```

## Data Structure

[Data 00] 00 : 3D On  
01 : 3D Off

02 : 3D to 2D  
03 : 2D to 3D

[Data 01] 00 : Top and Bottom

01 : Side by Side  
02 : Checker Board  
03 : Frame Sequential  
04 : Column interleaving  
05 : Row interleaving

[Data 02] 00 : Right to Left  
01 : Left to Right

[Data 03] 3D Effect(3D Depth): Min : 00 - Max : 14  
(\*transmit by Hexadecimal code)

- \* If [Data 00] is 00 (3D On), [Data 03] has no meaning.
- \* If [Data 00] is 01 (3D off) or 02 (3D to 2D), [Data 01], [Data 02] and [Data 03] have no meaning.
- \* If [Data 00] is 03(2D to 3D), [Data 01] and [Data 02] have no meaning.
- \* If [Data 00] is 03(2D to 3D), [Data 03] works when 3D Mode (Genre) is manual only.
- \* All 3D pattern options ([Data 01]) may not be available according to broadcasting/video signal.

[Data 00]	[Data 01]	[Data 02]	[Data 03]
00	O	O	X
01	X	X	X
02	X	X	X
03	X	X	O

X : don't care

```
Ack [t][ ][Set ID][ ][OK][Data00][Data01][Data02]
[Data03][x]
[t][ ][Set ID][ ][NG][Data00][x]
```

## 23. Extended 3D(Command: x v) (only 3D models)

(Depending on model)

► To change 3D option for TV.

```
Transmission [x][v][ ][Set ID][ ][Data 00][ ]
[Data 01][Cr]
```

[Data 00] 3D option

00 : 3D Picture Correction  
01 : 3D Depth (3D Mode is Manual Only)  
02 : 3D Viewpoint  
06 : 3D Color Correction

07 : 3D Sound Zooming

08 : Normal Image View

09 : 3D Mode (Genre)

[Data 01] It has own range for each 3D option determined by [Data 00].

1) When [Data 00] is 00

00 : Right to Left

01 : Left to Right

2) When [Data 00] is 01, 02

Data Min: 0 - Max: 14 (\*transmit by Hexadecimal code)

Data value range(0 - 20) converts Viewpoint range (-10 - +10) automatically (Depending on model)

3) When [Data 00] is 06, 07, 08

00 : Off

01 : On

4) When [Data 00] is 09

00 : Standard

01 : Sport

02 : Cinema

03 : Extreme

04 : Manual

```
Ack [v][ ][Set ID][ ][OK][Data00][Data01][x]
```

```
[v][ ][Set ID][ ][NG][Data00][x]
```

