

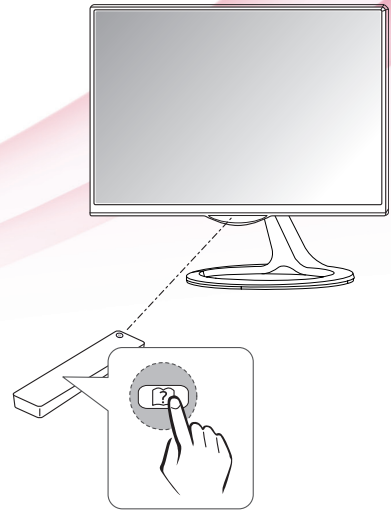

**LG**

Life's Good

ENGLISH



# OWNER'S MANUAL

# LED TV

LG LED TV applies LCD screen with LED backlights.

Please read this manual carefully before operating the your TV and retain it for future reference.

23MA73D

27MA73D

# TABLE OF CONTENTS

## **3 LICENSES**

---

## **4 INSTALLATION PROCEDURE**

---

## **5 ASSEMBLING AND PREPARING**

---

- 5 Unpacking
- 8 Parts and buttons
- 10 Lifting and moving the TV
- 11 Setting up the TV
  - 11 - Attaching the Stand
  - 13 - Mounting on a table
  - 14 - Tidying cables
  - 15 - Detaching the Stand
  - 16 - Mounting on a wall

## **18 WATCHING TV**

---

- 18 Turning the TV on for the first time

## **20 MAKING CONNECTIONS**

---

- 20 Connecting an antenna
- 21 Connecting to a HD receiver, DVD, VCR player or Gaming device
  - 21 - HDMI connection
  - 22 - HDMI to DVI connection
  - 23 - Component connection
  - 24 - Composite connection
  - 25 - Euro Scart connection
- 26 Headphone connection
- 27 Connecting to a USB
- 27 Connecting to a CI Module
- 28 MHL connection
- 29 Connecting to a PC
  - 30 - HDMI connection
  - 31 - HDMI to DVI connection
  - 32 - RGB connection

## **33 REMOTE CONTROL**

---

## **35 CUSTOMIZING SETTINGS**

---

- 35 Accessing main menus

## **36 USING THE USER GUIDE**

---

- 36 Accessing User Guide menu.
  - 36 - Using the TV menu
  - 36 - Using the Remote Control

## **37 MAINTENANCE**

---

- 37 Cleaning Your TV
  - 37 Screen and frame
  - 37 Cabinet and stand
  - 37 Power cord
- 38 Preventing "Image burn" or "Burn-in" on your TV screen

## **39 TROUBLESHOOTING**

---

- 39 General

## **40 SPECIFICATIONS**

---

# LICENSES

Supported licenses may differ by model. For more information of the licenses, visit [www.lg.com](http://www.lg.com).



Manufactured under license from Dolby Laboratories. Dolby and the double-D symbol are trademarks of Dolby Laboratories.



The terms HDMI and HDMI High-Definition Multimedia Interface, and the HDMI logo are trademarks or registered trademarks of HDMI Licensing LLC in the United States and other countries.



**ABOUT DIVX VIDEO:** DivX® is a digital video format created by DivX, LLC, a subsidiary of Rovi Corporation. This is an official DivX Certified® device that plays DivX video. Visit [divx.com](http://divx.com) for more information and software tools to convert your files into DivX videos.

**ABOUT DIVX VIDEO-ON-DEMAND:** This DivX Certified® device must be registered in order to play purchased DivX Video-on-Demand (VOD) movies. To obtain your registration code, locate the DivX VOD section in your device setup menu. Go to [vod.divx.com](http://vod.divx.com) for more information on how to complete your registration.

DivX Certified® to play DivX® video up to HD 1080p, including premium content.

DivX®, DivX Certified® and associated logos are trademarks of Rovi Corporation or its subsidiaries and are used under license.

Covered by one or more of the following U.S. patents: 7,295,673; 7,460,668; 7,515,710; 7,519,274

# INSTALLATION PROCEDURE

- 1 Open the package and make sure all the accessories are included.
- 2 Attach the stand to the TV.
- 3 Connect an external device to the TV.



## **NOTE**

- Image shown may differ from your TV.
- Your TV's OSD (On Screen Display) may differ slightly from that shown in this manual.
- The available menus and options may differ from the input source or product model that you are using.
- New features may be added to this TV in the future.

# ASSEMBLING AND PREPARING

## Unpacking

Check your product box for the following items. If there are any missing accessories, contact the local dealer where you purchased your product. The illustrations in this manual may differ from the actual product and accessories.

### ! NOTE

- The accessories supplied with your product may vary depending on the model.
- Product specifications or contents in this manual may be changed without prior notice due to upgrade of product functions.

### ! CAUTION

- Do not use any pirated items to ensure the safety and product life span.
- Any damages or injuries by using pirated items are not covered by the warranty.

### ! NOTE

- The items supplied with your product may vary depending on the model.
- Product specifications or contents of this manual may be changed without prior notice due to upgrade of product functions.
- For an optimal connection, HDMI cables and USB devices should have bezels less than 10 mm thick and 18 mm width. Use an extension cable that supports USB 2.0 if the USB cable or USB memory stick does not fit into your TV's USB port.

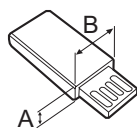
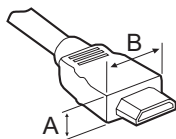

\*A  10 mm

\*B  18 mm

23MA73D 27MA73D

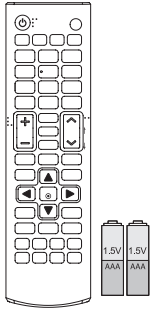

**Remote control  
Batteries (AAA)**

(See p.33, See p.34)

---



**CD (Owner's Manual).  
Cards**

---

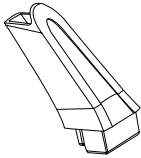

**Stand Body**

(See p.11, See p. 15)

---



**Stand Base**

(See p.11, See p. 15)

---



**Cable Holder**

(See p.14)

---

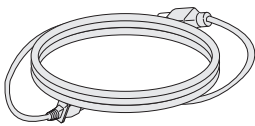

**Power Cord**

(See p.13)

---

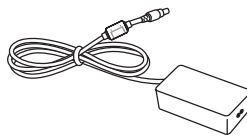

**AC-DC Adapter**

(See p.13)

---

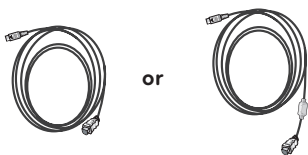

**MHL passive cable**

(See p.28)

---



**Isolator**

(Depending on the country)

---

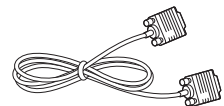

**RGB cable**

(See p.32)

---

**!** NOTE

• Antenna Isolator Installation Guide

- Use this to install TV in a place where there is a voltage difference between TV Set and GND of antenna signal.
  - » If there is a voltage difference between TV Set and GND of antenna signal, the antenna contact might be heated and excessive heat might cause an accident.
- You can improve the safety when watching TV by efficiently removing power voltage from TV antenna. It is recommended to mount the isolator to the wall. If it cannot be mounted to the wall, mount it on the TV. Avoid disconnecting the antenna Isolator after installation.
- Before starting, be sure that the TV antenna is connected.

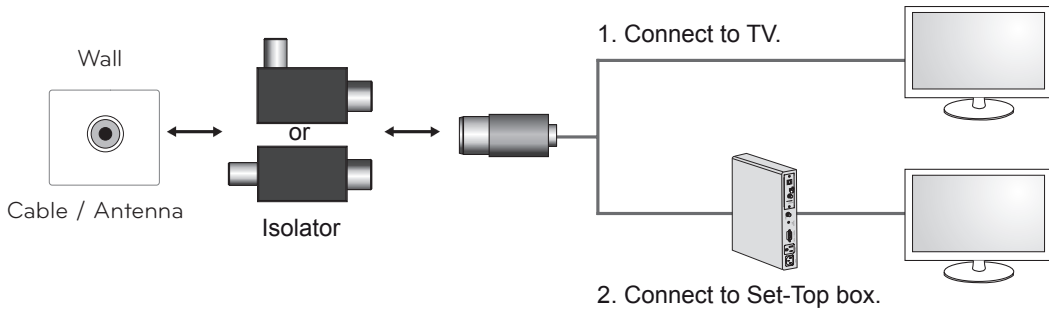

Connect one end of the isolator to cable/antenna jack and the other to TV set or set-top box.

"Equipment connected to the protective earthing of the building installation through the mains connection or through other equipment with a connection to protective earthing - and to a cable distribution system using coaxial cable, may in some circumstances create a fire hazard. Connection to a cable distribution system has therefore to be provided through a device providing electrical isolation below a certain frequency range (galvanic isolator, see EN 60728-11)"

When applying the RF Isolator, a slight loss of signal sensitivity can occur.

## Parts and buttons

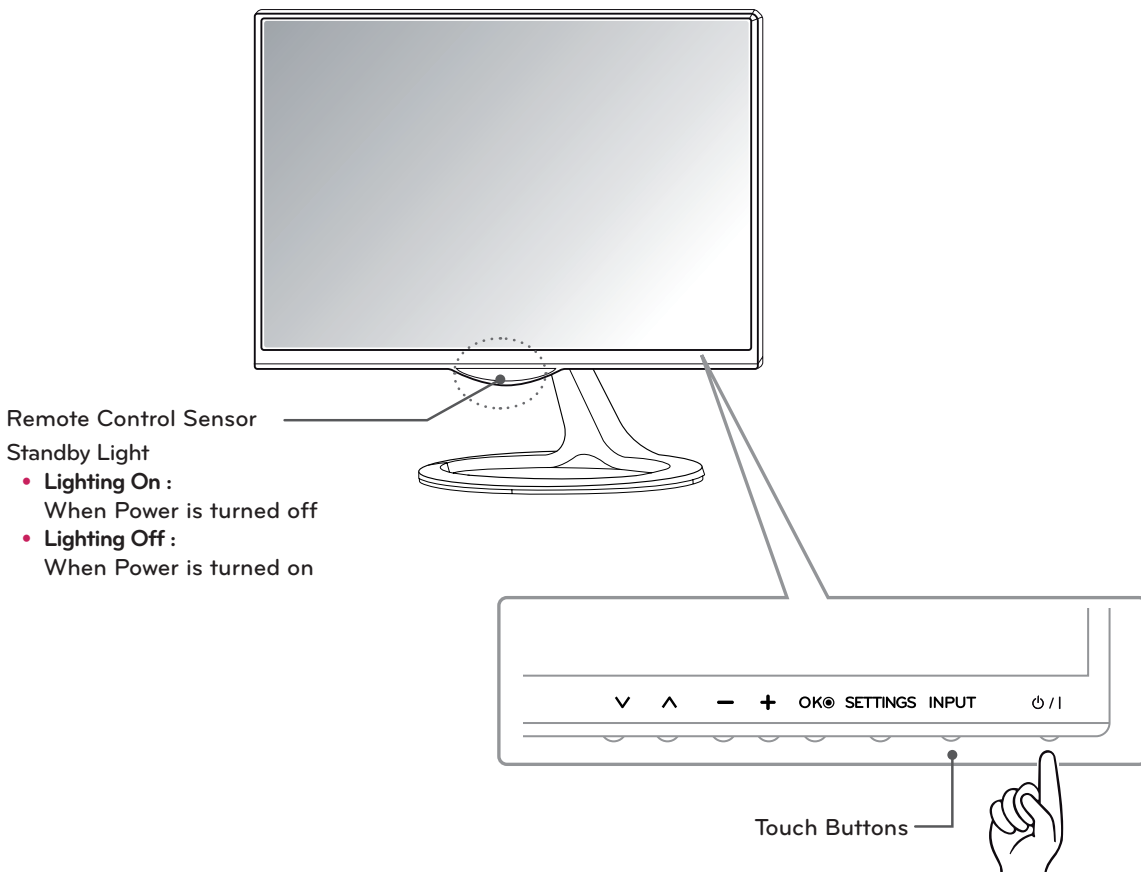

### NOTE

All of the buttons are touch sensitive and can be operated through simple touch with your finger. Power and control touch button are located on the bottom.

Touch button	Description
∨ ^	Scrolls through the saved programmes.
- +	Adjusts the volume level.
OK	Selects the highlighted menu option or confirms an input.
SETTINGS	Accesses the main menus, or saves your input and exits the menus.
INPUT	Changes the input source.
⏻ / I	Turns the power on or off.



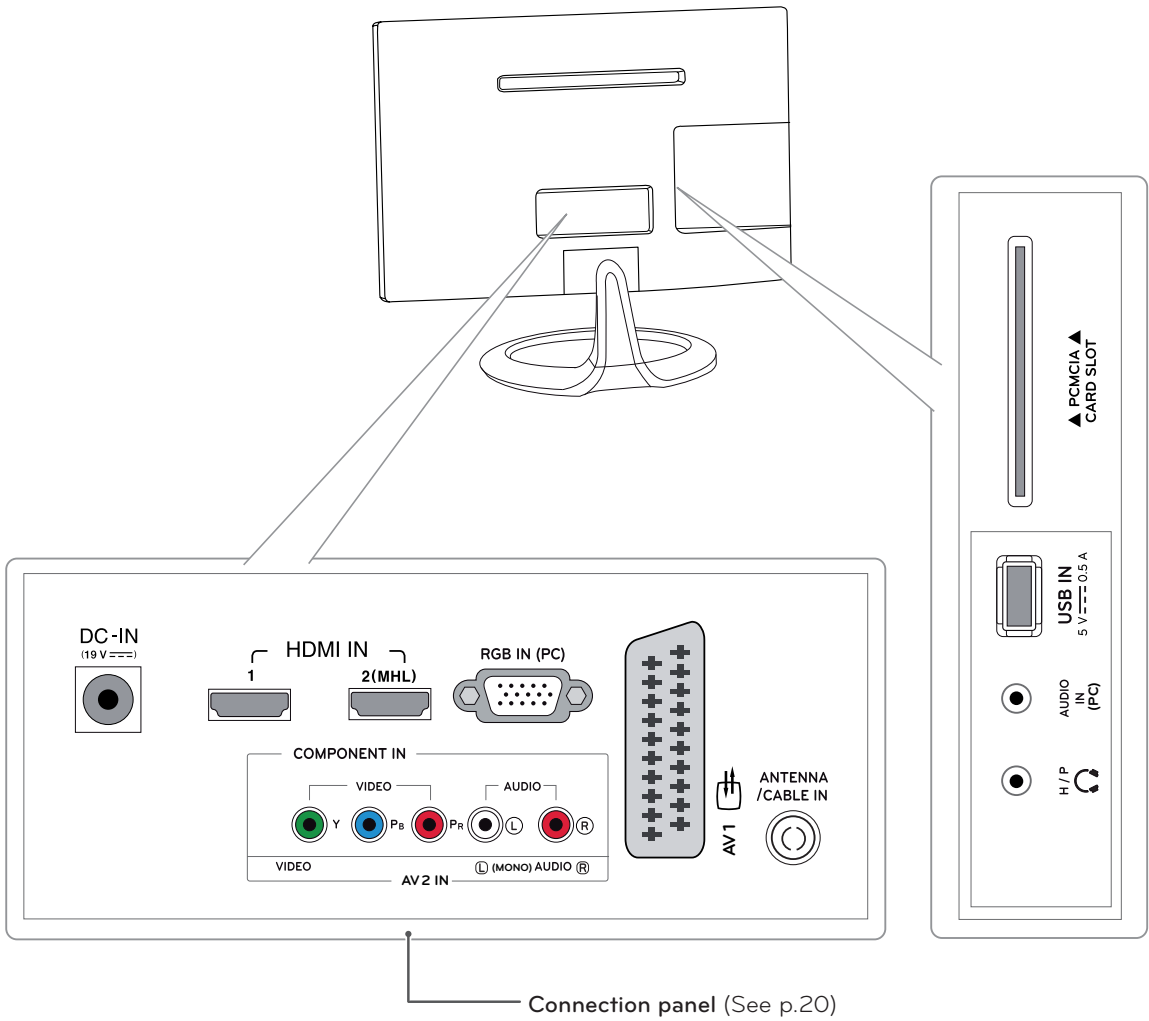

## Lifting and moving the TV

When moving or lifting the TV, read the following to prevent the TV from being scratched or damaged and for safe transportation regardless of its type and size.



### CAUTION

Avoid touching the screen at all times, as this may result in damage to the screen or some of the pixels used to create images.

- It is recommended to move the TV in the box or packing material that the TV originally came in.
- Before moving or lifting the TV, disconnect the power cord and all cables.
- Hold the top and bottom of the TV frame firmly. Make sure not to hold the transparent part, speaker, or speaker grill area.

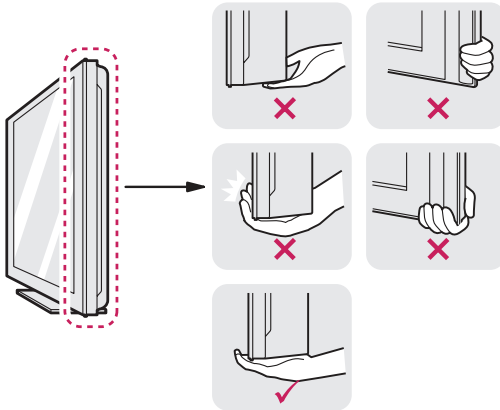

- When holding the TV, the screen should face away from you to prevent the screen from scratches.



- When transporting the TV, do not expose the TV to jolts or excessive vibration.
- When transporting the TV, keep the TV upright, never turn the TV on its side, or tilt towards the left or right.

## Setting up the TV

### Attaching the Stand

If you are not mounting the TV to a wall, use the following instructions to attach the stand.

- 1 Place the TV with the screen side down on a flat and cushioned surface.

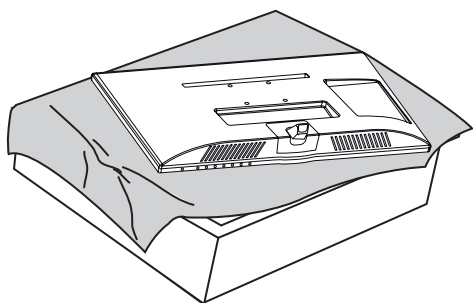

#### CAUTION

- Lay a foam mat or soft protective cloth on the surface to protect the screen from damage.
- When attaching the stand to the TV, place the screen facing down on a cushioned table or flat surface to protect the screen from scratches.

- 2 Attach the **Stand Base** from the **Stand Body** by turning the screw to the right with a **Coin**.

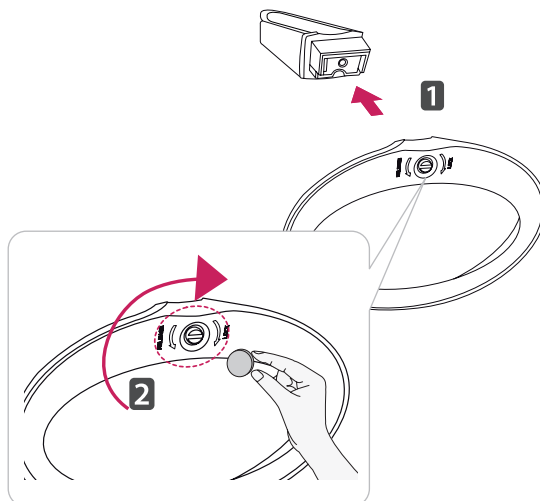

#### CAUTION

Tighten the screws firmly to prevent the TV from tilting forward. Do not over tighten.

- 3 Attach the **Stand Body** from the TV.

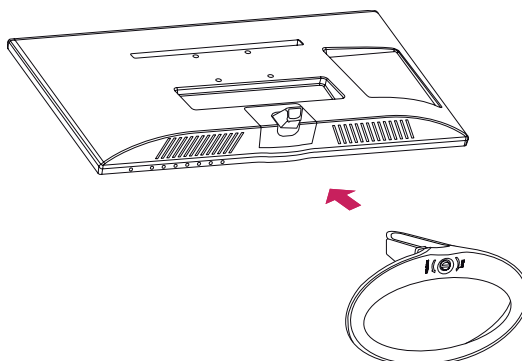

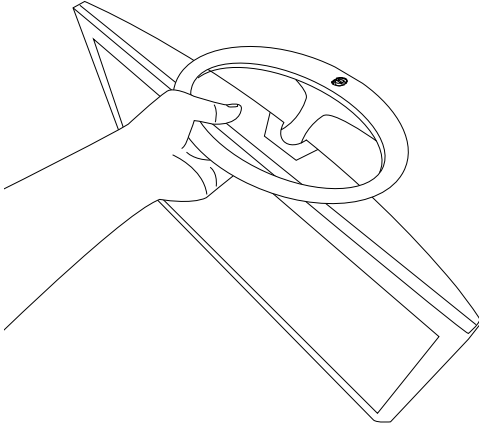
**CAUTION**

- Do not carry the monitor upside-down as this may cause it to fall off its stand, resulting in damage or injury.
- The illustration shows a general example of installation and may look different from the actual product.

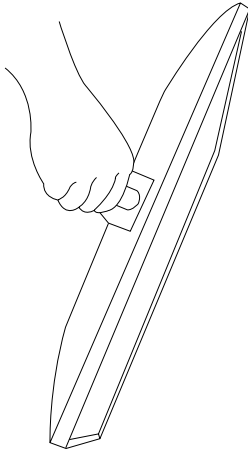

- Do not carry the monitor upside-down by holding the stand body as this may cause it to fall off, resulting in damage or injury.
- The illustration shows a general example of installation and may look different from the actual product.

## Mounting on a table

- 1 Lift and tilt the TV into its upright position on a table.

Leave a 10 cm (4 inches) (minimum) space from the wall for proper ventilation.

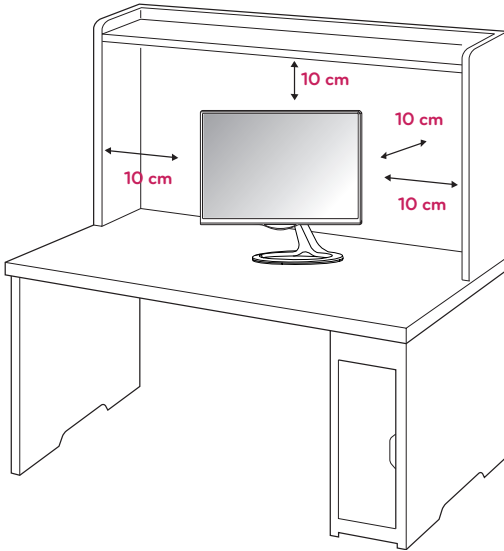

- 2 Connect the **AC-DC Adapter** and **Power Cord** to a wall outlet.

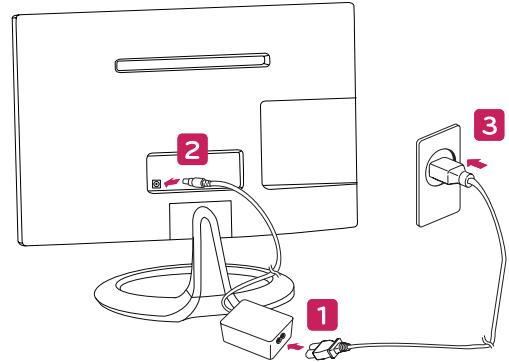

### CAUTION

Do not place the TV near or on sources of heat, as this may result in fire or other damage.



### WARNING

When you adjust the angle, do not hold the bottom of the TV frame as shown on the following illustration, as may injure your fingers.

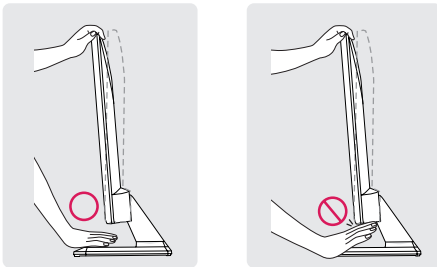

### NOTE

Tilt from +20 to -5 degrees up or down to adjust the angle of the TV to suit your view.

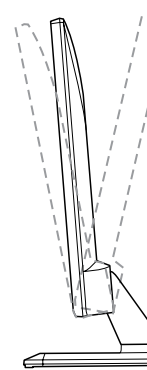

Front

Rear



### CAUTION

Disconnect the power cord first, and then move or install the TV. Otherwise electric shock may occur.

## Tidying cables

- 1 Attach the cable holder to the edge of stand body securely.
- 2 Gather and bind the cables with the supplied cable holder.

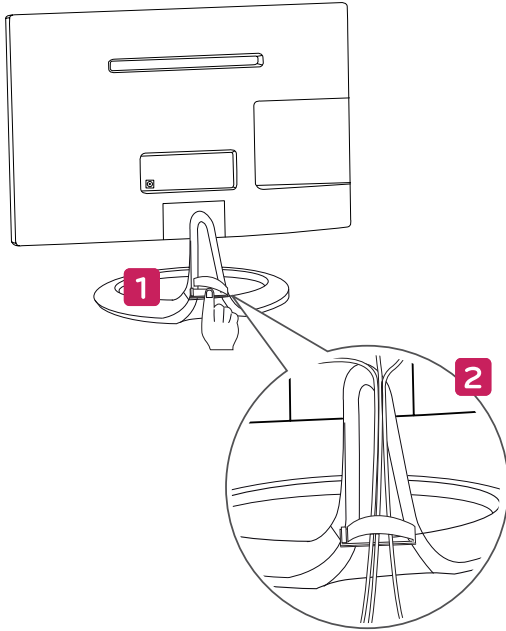

### CAUTION

After attachment, if the cable holder is pulled with excessive force, it may fall off.

### Using the Kensington security system

The Kensington security system connector is located at the back of the TV. For more information of installation and using, refer to the manual supplied with the Kensington security system or visit <http://www.kensington.com>.

Connect the Kensington security system cable between the TV and a table.

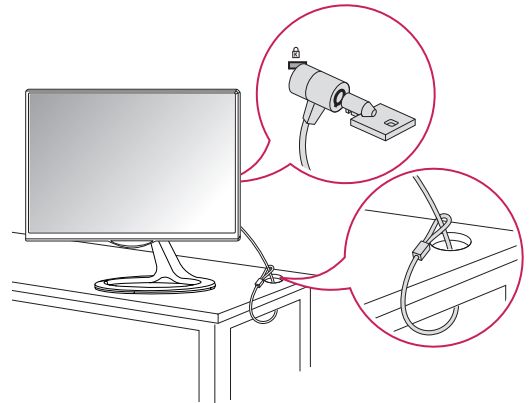

### NOTE

The Kensington security system is optional. You can obtain additional accessories from most electronics stores.

## Detaching the Stand

- 1 Place the TV with the screen side down on a flat and cushioned surface.

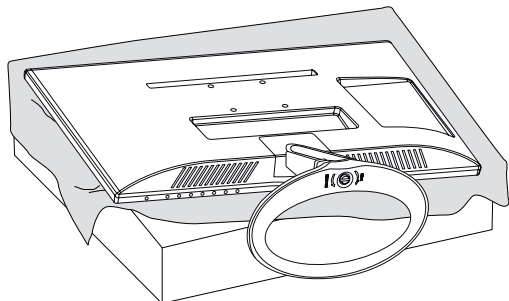

### CAUTION

- Lay a foam mat or soft protective cloth on the surface to protect the screen from damage.
- When detaching the stand to the TV, place the screen facing down on a cushioned table or flat surface to protect the screen from scratches.

- 2 Pull out the **Stand Body** from the TV.

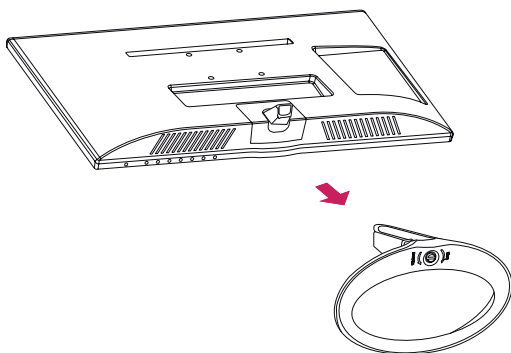

- 3 Turn the screw to the left, and then pull out the **Stand Base** from the **Stand Body**.

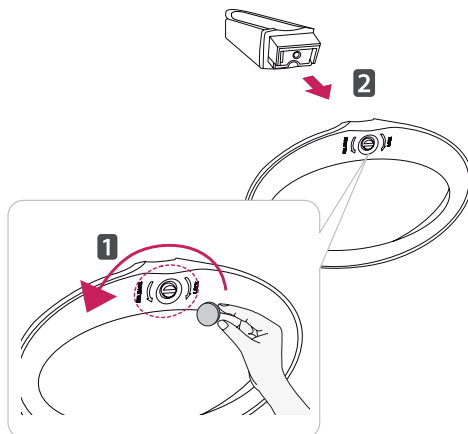

## Mounting on a wall

For proper ventilation, allow a clearance of 10 cm on each side and from the wall. Detailed installation instructions are available from your dealer, see the optional Tilt Wall Mounting Bracket Installation and Setup Guide.

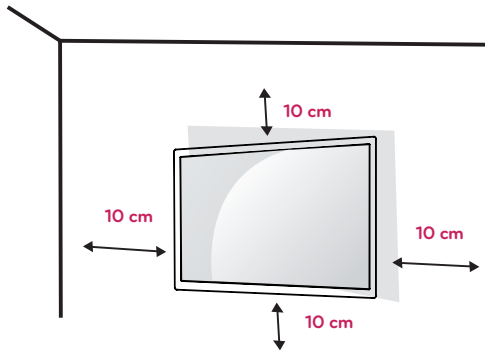

If you intend to mount the TV to a wall, attach Wall mounting interface (optional parts) to the back of the TV.

When you install the TV using the wall mounting interface (optional parts), attach it carefully so it will not drop.

- 1 Please, Use the screw and wall mount interface in accordance with VESA Standards.
- 2 If you use screw longer than standard, the TV might be damaged internally.
- 3 If you use improper screw, the product might be damaged and drop from mounted position. In this case, LG Electronics is not responsible for it.
- 4 VESA compatible only with respect to screw mounting interface dimensions and mounting screw specifications.

5 Please use VESA standard as below.

- 784.8 mm (30.9 inch) and under
  - \* Wall Mount Pad Thickness : 2.6 mm
  - \* Screw :  $\Phi$  4.0 mm x Pitch 0.7 mm x Length 10 mm
- 787.4 mm (31.0 inch) and above
  - \* Please use VESA standard wall mount pad and screws.

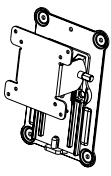
<b>Model</b>	<b>23MA73D</b>	<b>27MA73D</b>
<b>VESA (A x B)</b>	75 x 75	100 x 100
<b>Standard screw</b>	M4	M4
<b>Number of screws</b>	4	4
<b>Wall mount bracket (optional)</b>	RW120 	

- VESA (A x B)

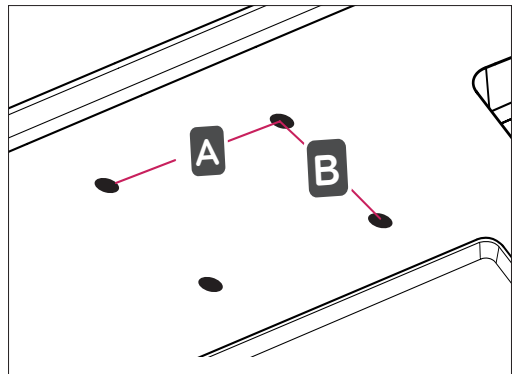



**CAUTION**

- Disconnect the power cord first, and then move or install the TV. Otherwise electric shock may occur.
- If you install the TV on a ceiling or slanted wall, it may fall and result in severe injury.
- Use an authorized LG wall mount and contact the local dealer or qualified personnel.
- Do not over tighten the screws as this may cause damage to the TV and void your warranty.
- Use the screws and wall mounts that meet the VESA standard. Any damages or injuries by misuse or using an improper accessory are not covered by the warranty.

**NOTE**

- Use the screws that are listed on the VESA standard screw specifications.
- The wall mount kit includes an installation manual and necessary parts.
- The wall mount bracket is optional. You can obtain additional accessories from your local dealer.
- The length of screws may differ depending on the wall mount. Be sure to use the proper length.
- For more information, refer to the instructions supplied with the wall mount.

# WATCHING TV

## Turning the TV on for the first time

When you access the TV for the first time, the initial setting screen appears. Select a language and customize the basic settings.

- 1 Connect the power cord to a power outlet.
- 2 Press  on the TV or power button on the remote control to turn the TV on.  
The Standby Light is turned off.



### NOTE

When the TV is in Power saving mode, the Standby Light turns amber.

- 3 The initial setting screen appears if you access the TV for the first time.



### NOTE

If you do not operate the TV within 40 seconds when the setting menu screen appears, the setting menus will disappear.

- 4 Follow the on-screen instructions to customize your TV according to your preferences.

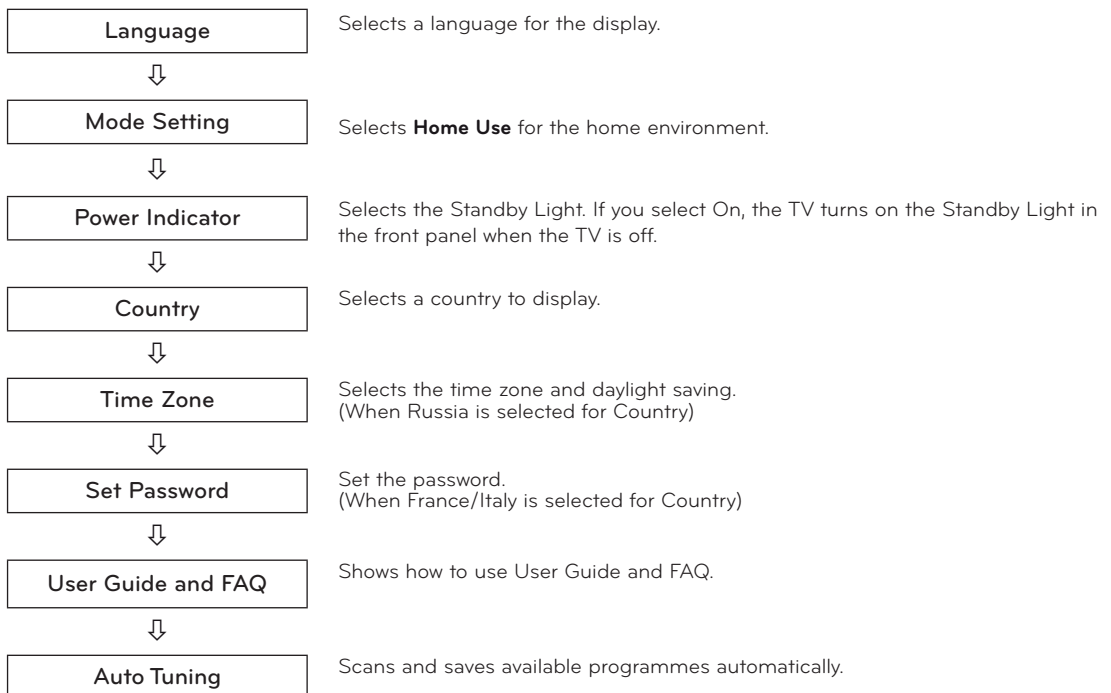

 **NOTE**

- For those countries without confirmed DTV broadcasting standards, some DTV features might not work, depending on the DTV broadcasting environment.
- When France is selected for Country, the initial password is not '0', '0', '0', '0' but '1', '2', '3', '4'.
- To display images in the best quality for your home environment, select **Home Use mode**.
- **Store Demo mode** is suitable for the retail environment.
- If you select **Store Demo mode**, the previously customized settings will switch to the default settings of **Store Demo mode** in 5 minutes.

5 When the basic settings are complete, press **OK**.

 **NOTE**

If you do not complete the initial setting, it will appear whenever you access the TV.

6 To turn the TV off, press  on the TV.  
The Standby Light is turned on.

 **CAUTION**

Disconnect the power cord from the power outlet when you do not use the TV for a long period of time.

 **NOTE**

- You can also switch the TV from PC mode to TV mode, press **TV/PC**.
- You can also access **Factory Reset** by accessing **OPTION** in the main menus.

## MAKING CONNECTIONS

Connect various external devices to the TV and switch input modes to select an external device. For more information about an external device's connection, refer to the manual supplied with each device.

Available external devices are: HD receivers, DVD players, VCRs, audio systems, USB storage devices, PC, camcorders or cameras, gaming devices, and other external devices.

### ! NOTE

- If you record a TV program on a DVD recorder or VCR, make sure to connect the TV signal input cable to the TV through a DVD recorder or VCR. For more information about recording, refer to the manual supplied with the connected device.
- The external device connection may differ from the model.
- Connect external devices to the TV regardless of the order of the TV port.

## Connecting an antenna

Connect an antenna, cable or cable box to watch TV referring to the following. The illustrations may differ from the actual accessories and an RF cable is optional.

Connect the TV to a wall antenna socket with an RF cable (75  $\Omega$ ).

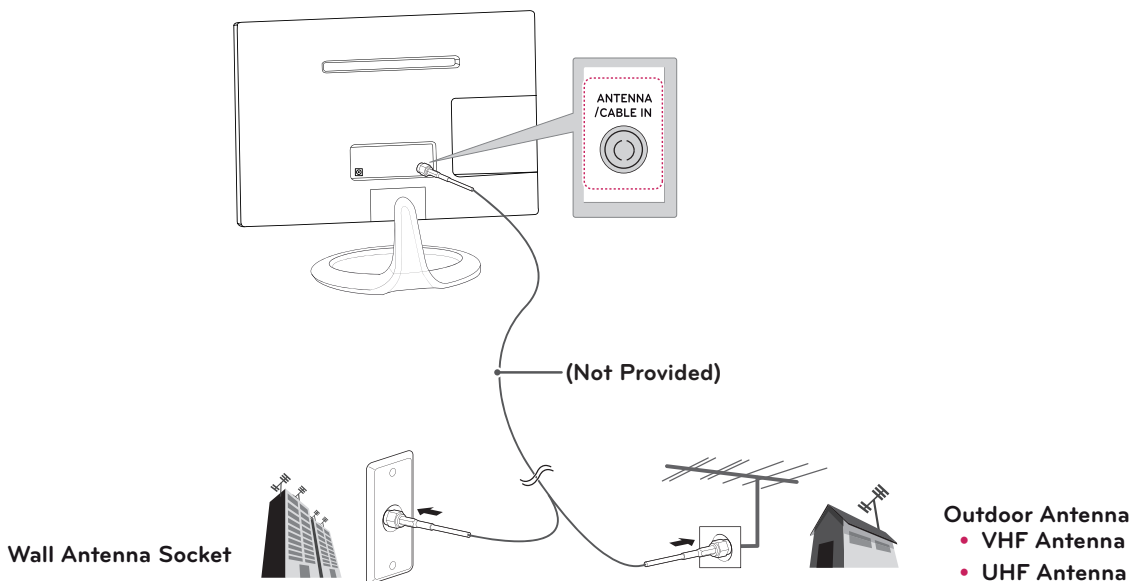

### ! NOTE

- Use a signal splitter to use more than 2 TVs.
- If the image quality is poor, install a signal amplifier properly to improve the image quality.
- If the image quality is poor with an antenna connected, aim the antenna to the proper direction.
- Visit <http://AntennaWeb.org> for more information about the antenna and cable connection.

### ! CAUTION

- Make sure not to bend the copper wire of the RF cable.

Copper wire

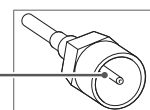

- Complete all connections instructions between devices, and then connect the power cord to the power outlet to prevent damages to your TV.

## Connecting to a HD receiver, DVD, VCR player or Gaming device

Connect a HD receiver, DVD, VCR player or Gaming device to the TV and select an appropriate input mode.

### HDMI connection

**HDMI is the best way to connect a device.**

Transmits the digital video and audio signals from an external device to the TV. Connect the external device and the TV with the HDMI cable as shown on the following illustration.

**NOTE**

- Use a High Speed HDMI™ Cable.
- High Speed HDMI™ Cables are tested to carry an HD signal up to 1080p and higher.
- Supported DTV Audio: MPEG, Dolby Digital.
- Supported HDMI Audio format: Dolby Digital, PCM (Up to 192 KHz, 32k/44.1k/48k/88k/96k/176k/192k, DTS Not supported.)

- Choose any HDMI input port to connect.
- It does not matter which port you use.

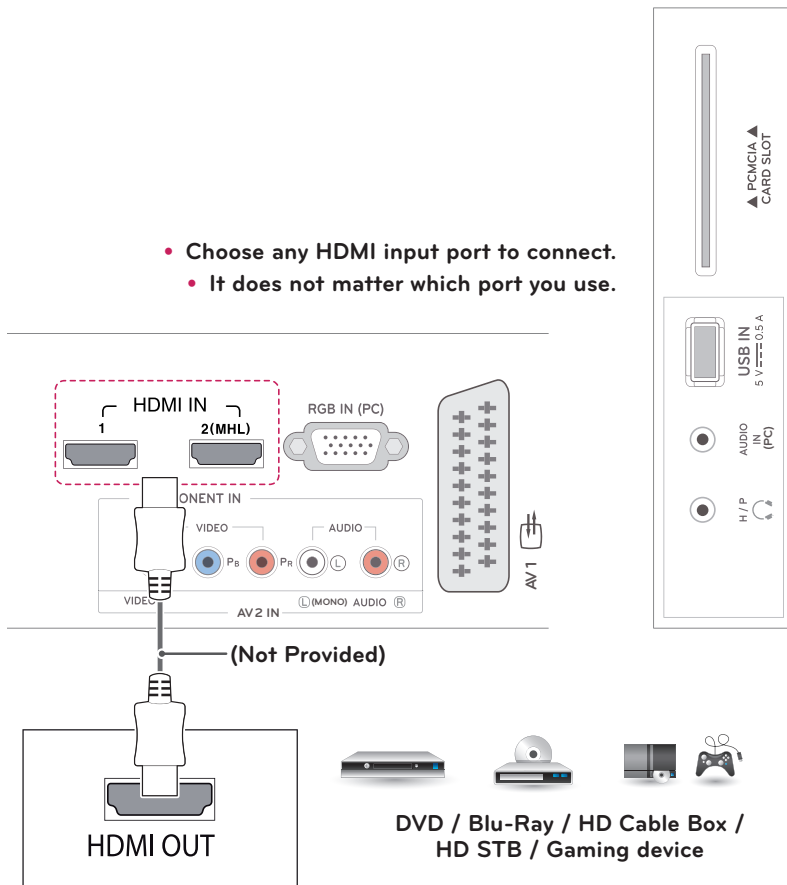

## HDMI to DVI connection

Transmits the digital video signal from an external device to the TV. Connect the external device and the TV with the HDMI to DVI cable as shown in the following illustration. To transmit an audio signal, connect an optional audio cable.

**NOTE** If you do not use an optional external speaker, connect the external device to the TV with the optional audio cable.

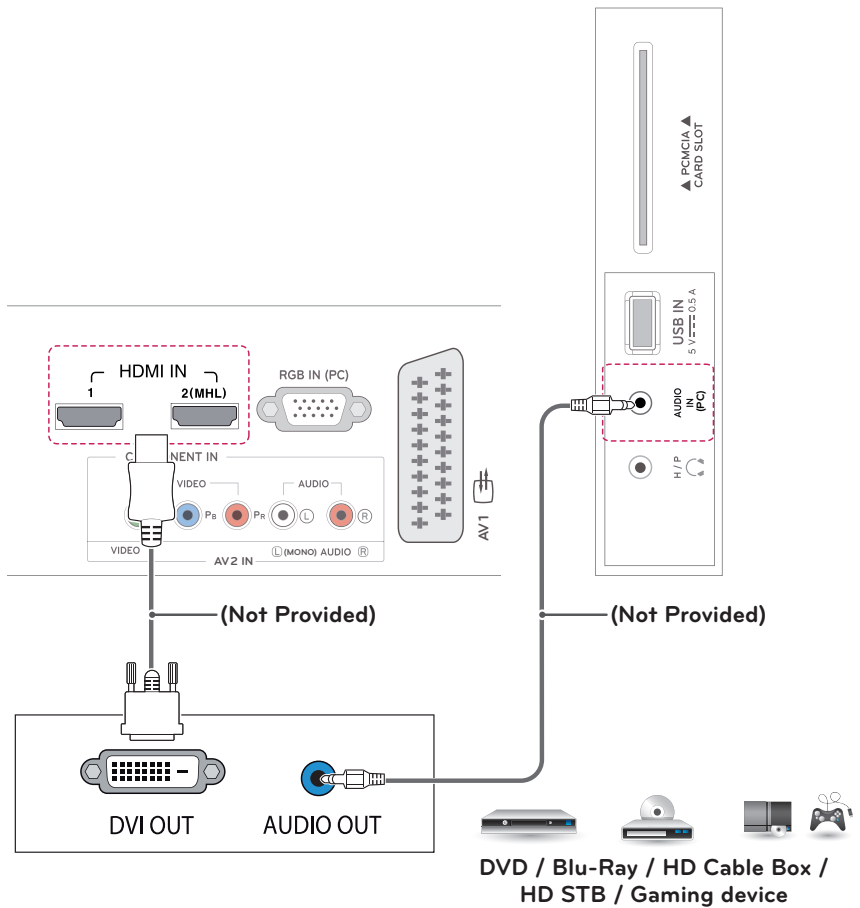

## Component connection

Transmits the analog video and audio signals from an external device to the TV. Connect the external device and the TV with the component cable as shown on the following illustration. To display images by using progressive scan, make sure to use the component cable.

**NOTE**

- If cables are installed incorrectly, it could case the image to display in black and white or with distorted color.
- **Check to ensure the cable are matched with the corresponding color connection.**

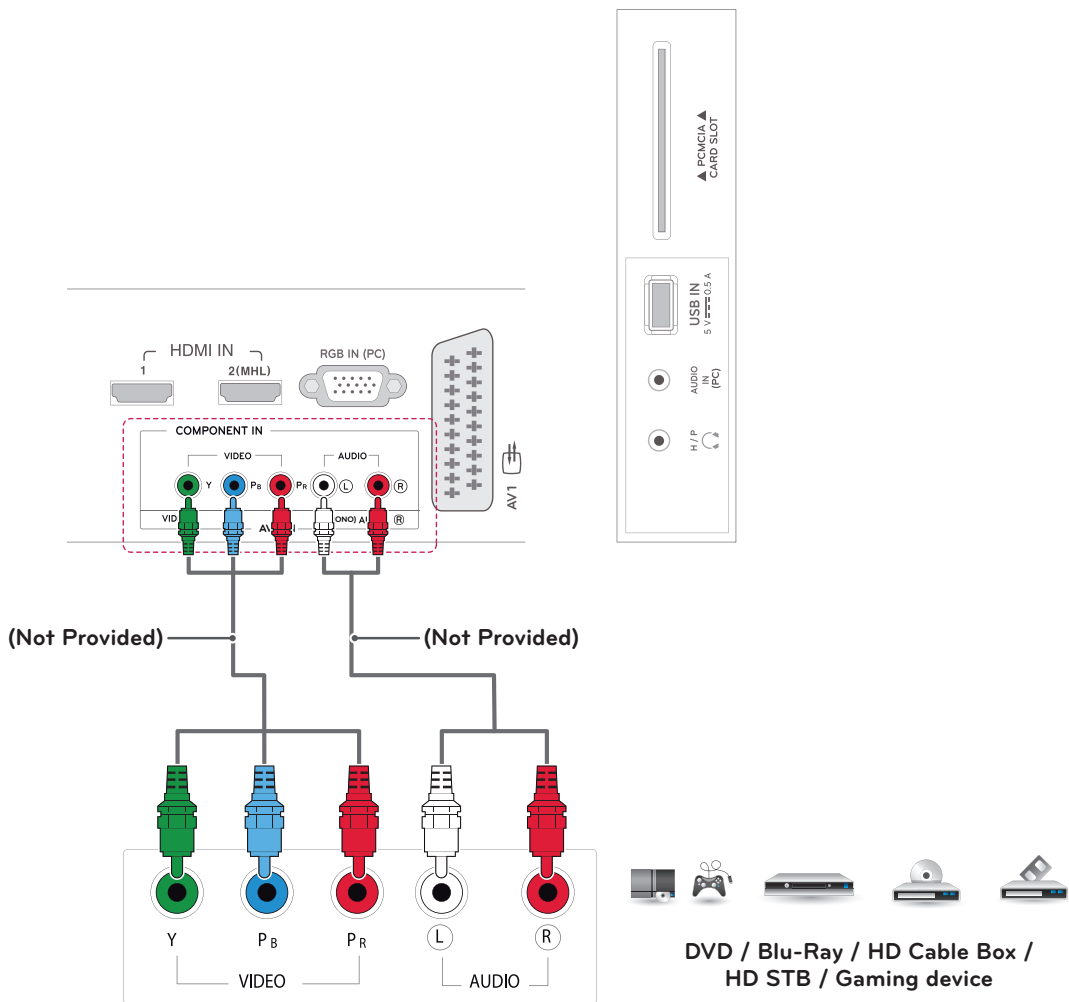

## Composite connection

Transmits the analog video and audio signals from an external device to the TV. Connect the external device and the TV with the composite cable as shown on the following illustration.

**NOTE**

Check to ensure the cable are matched with the corresponding color connection.

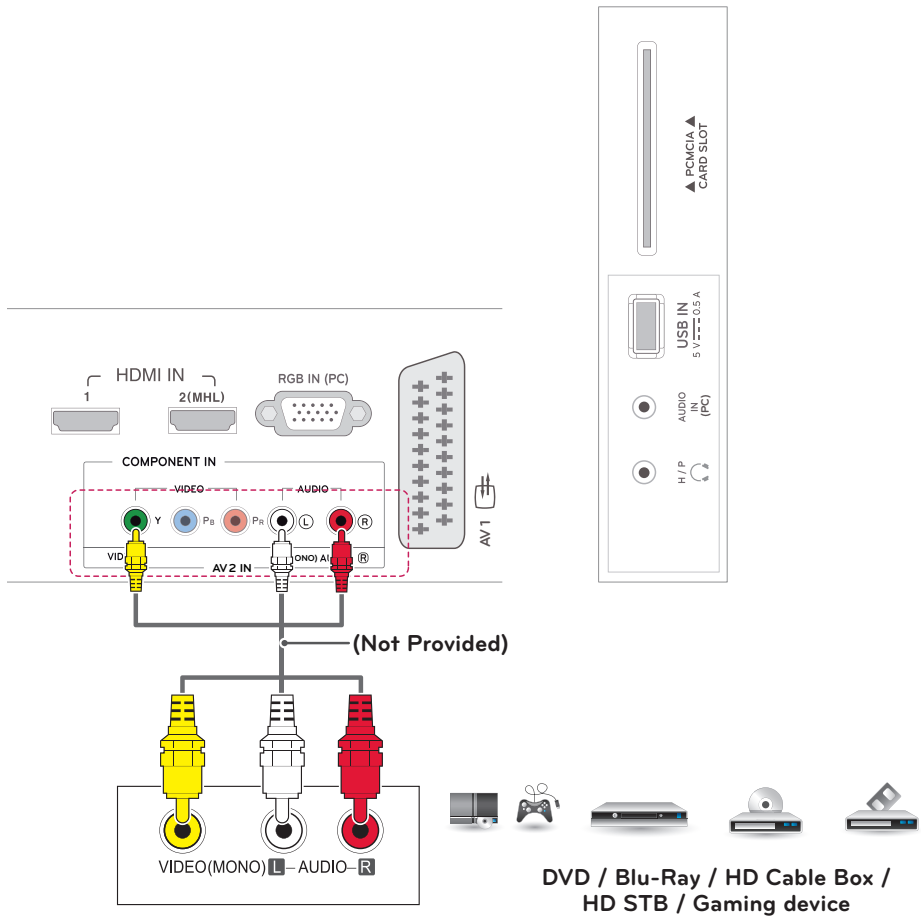



## Euro Scart connection

Transmits the video and audio signals from an external device to the TV. Connect the external device and the TV with the Euro Scart cable as shown on the following illustration. To display images by using progressive scan, make sure to use the Euro Scart cable.

Current input mode	Output Type	AV1 (TV Out <sup>1</sup> )
Digital TV		Digital TV
Analogue TV		Analogue TV
Component, AV, HDMI, RGB		Analogue TV

1 TV Out : Outputs Analogue TV or Digital TV signals.

**! NOTE**

Any Euro scart cable used must be signal shielded.

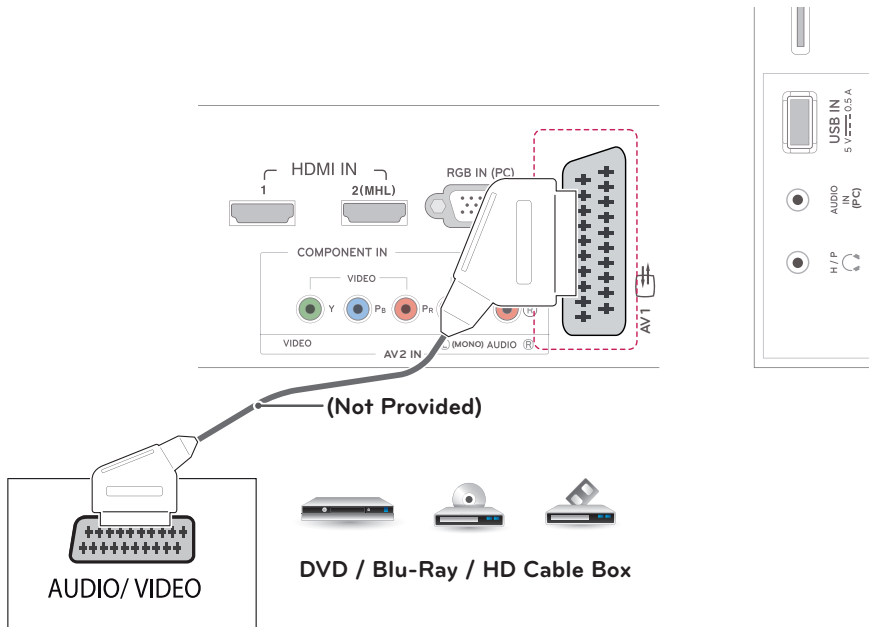

## Headphone connection

Transmits the headphone signal from the TV to an external device. Connect the TV with the headphone as shown on the following illustration.

### ! NOTE

- AUDIO menu items are disabled when connecting a headphone.
- Headphone impedance: 16  $\Omega$
- Max audio output of headphone: 10 mW to 15 mW
- Headphone jack size: 0.35 cm

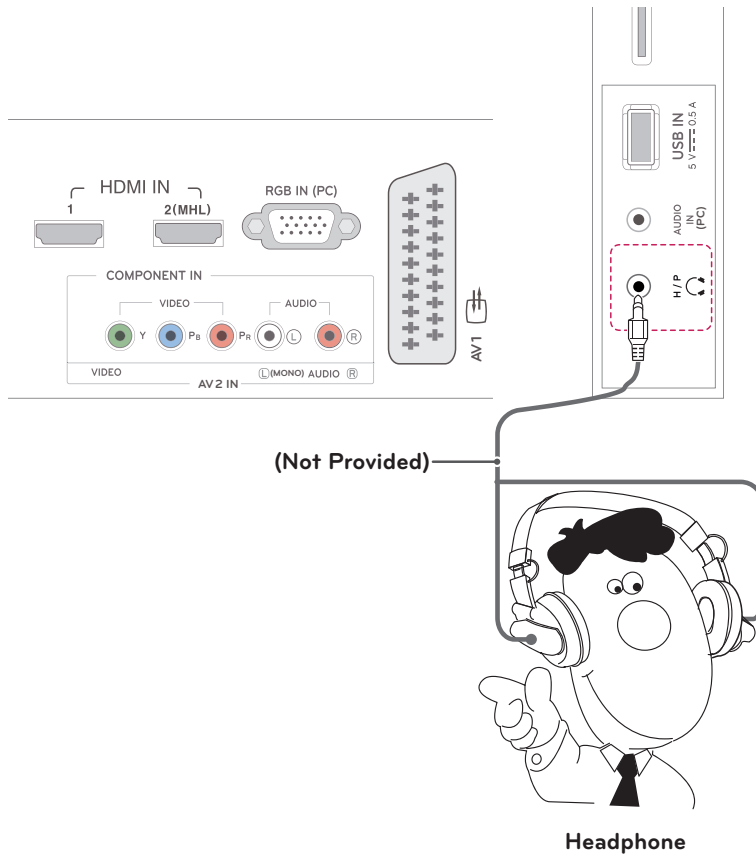

## Connecting to a USB

Connect a USB storage device such as a USB flash memory, external hard drive, MP3 player or a USB memory card reader to the TV and access the USB menu to use various multimedia files.

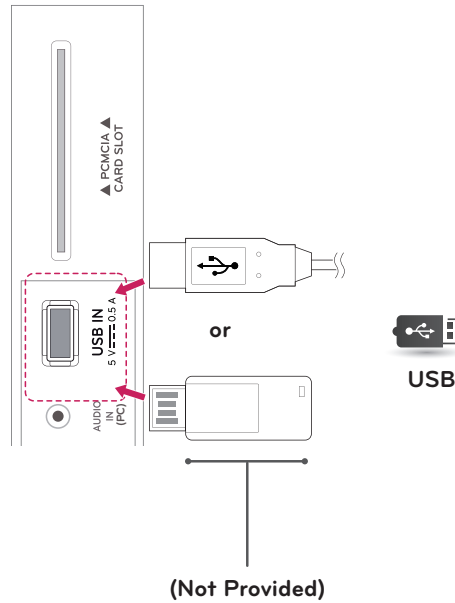

## Connecting to a CI Module

View the encrypted (pay) services in digital TV mode. This feature is not available in all countries.

**NOTE**

- Check if the CI module is inserted into the PCMCIA card slot in the right direction. If the module is not inserted properly, this can cause damage to the TV and the PCMCIA card slot.
- If the TV does not display any video and audio when CI+ CAM is connected, please contact to the Terrestrial/Cable/Satellite Service Operator.

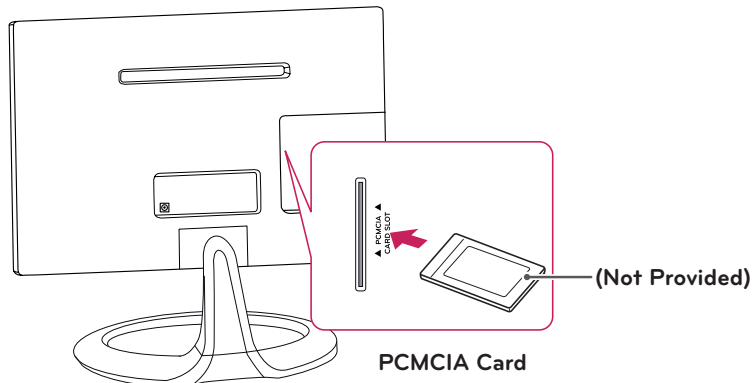

## MHL connection

Mobile High-definition Link (MHL) is an interface for transmitting digital audiovisual signals from mobile phones to television sets.

### ! NOTE

- Connect the mobile phone to the HDMI IN 2(MHL) port to view the phone screen on the TV.
- The MHL passive cable is needed to connect the TV and a mobile phone.
- This only works for the MHL-enabled phone.
- Some applications can be operated by the remote control.
- Remove the MHL passive cable from the TV when:
  - The MHL function is disabled.
  - Your mobile device is fully charged in standby mode.

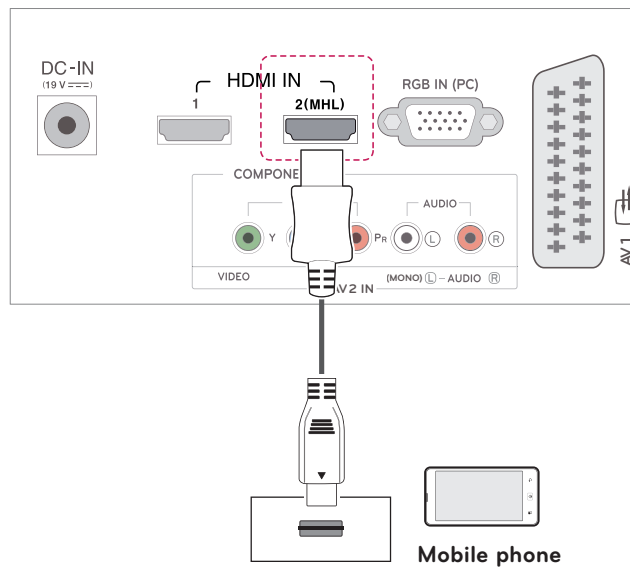

## Connecting to a PC

Your TV supports the Plug & Play\* feature and has the built-in speakers with Virtual Surround that reproduces sound clearly with a rich bass.

\* Plug & Play: The function when a PC recognizes a connected device that users connect to a PC and turn on, without device configuration or user intervention.

### ! NOTE

- It is recommended to use the TV with the HDMI connection for the best image quality.
- If you do not use an optional external speaker, connect the PC to the TV with the optional audio cable.
- If you turn the TV on when the set becomes cold, the screen may flicker. This is normal.
- Use a shielded signal interface cable, such as D-sub 15 pin signal cable and HDMI to DVI cable, with a ferrite core to maintain standard compliance for the product.
- Some red, green, or blue spots may appear on the screen. This is normal.
- Connect the signal input cable and tighten it by turning the screws clockwise.
- Do not press the screen with your finger for a long time as this may result in temporary distortion on the screen.
- Avoid displaying a fixed image on the screen for a long period of time to prevent image burn. Use a screensaver if possible.

### ! NOTE

- If you want to use HDMI-PC mode, you must set the input label to PC mode.
- The **OSD (On Screen Display)** is displayed on the screen as shown below.
  - » When turning the product on in **HDMI** input.
  - » When switching to **HDMI** input.

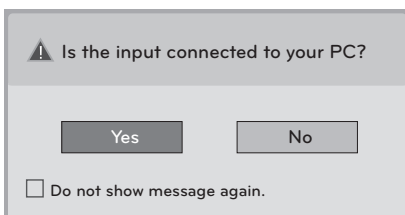

- If you select "**Yes**" the size and image quality are optimised for your PC.
- If you select "**No**" the size and image quality are optimised for the **AV device (DVD player, set-top box, gaming device)**.
- If you select "**Do not show message again**" this message does not appear until the TV is reset. You can change the set value in **SETTINGS ► INPUT ► Input Label**.
- The values set for HDMI1/HDMI2 are saved independently.

## HDMI connection

Transmits the digital video and audio signals from your PC to the TV. Connect the PC and the TV with the HDMI cable as shown in the following illustrations. You should set PC as an input label to connect the PC to the TV with an HDMI connection.

**NOTE**

- Use a High Speed HDMI™ Cable.
- High Speed HDMI™ Cables are tested to carry an HD signal up to 1080p and higher.
- If you want to use HDMI-PC mode, you must set the input label to PC or DVI mode.
- Supported DTV Audio: MPEG, Dolby Digital.
- Supported HDMI Audio format: Dolby Digital, PCM (Up to 192 KHz, 32k/44.1k/48k/88k/96k/176k/192k, DTS Not supported.)

- Choose any HDMI input port to connect.
- It does not matter which port you use.

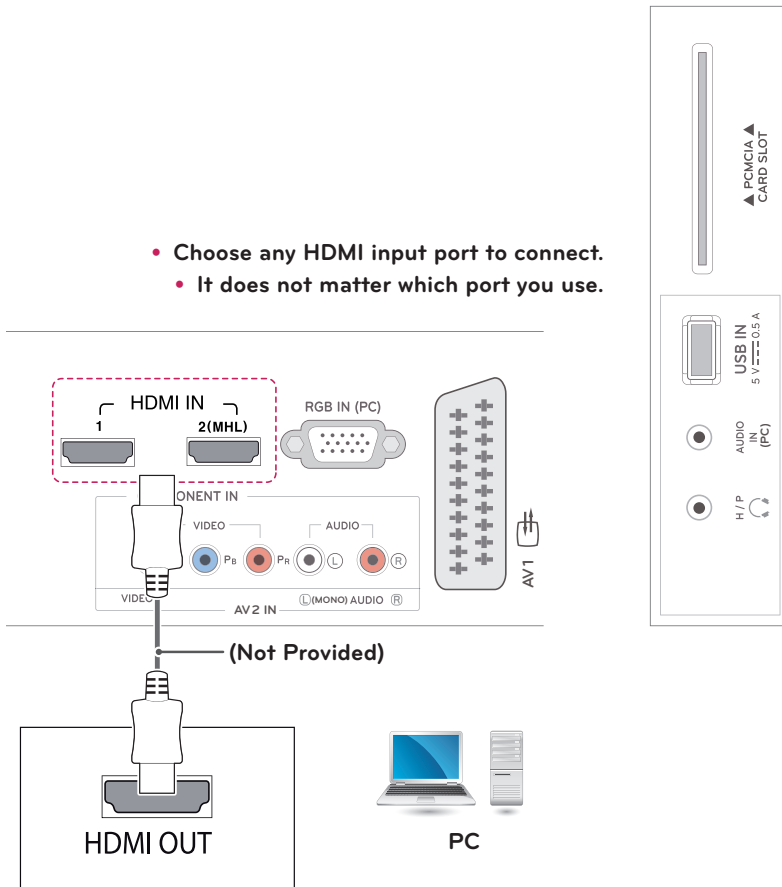

## HDMI to DVI connection

Transmits the digital video signal from your PC to the TV. Connect the PC and the TV with the HDMI to DVI cable as shown the following illustrations. To transmit an audio signal, connect an optional audio cable.

**NOTE**

- If you want to use HDMI-PC mode, you must set the input label to DVI mode.
- If you do not use an optional external speaker, connect the PC to the TV with the optional audio cable.

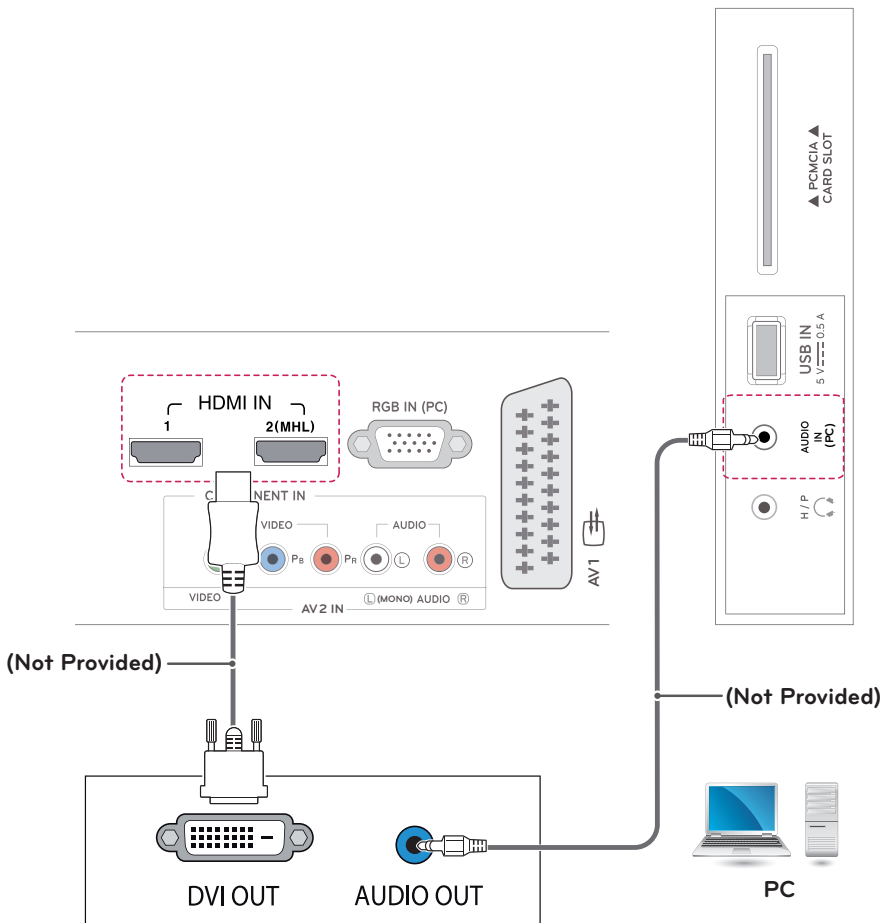

## RGB connection

Transmits the analog video signal from your PC to the TV. Connect the PC and the TV with the D-sub 15 pin cable as shown the following illustrations. To transmit an audio signal, connect an optional audio cable.

### ! NOTE

If you do not use an optional external speaker, connect the PC to the TV with the optional audio cable.

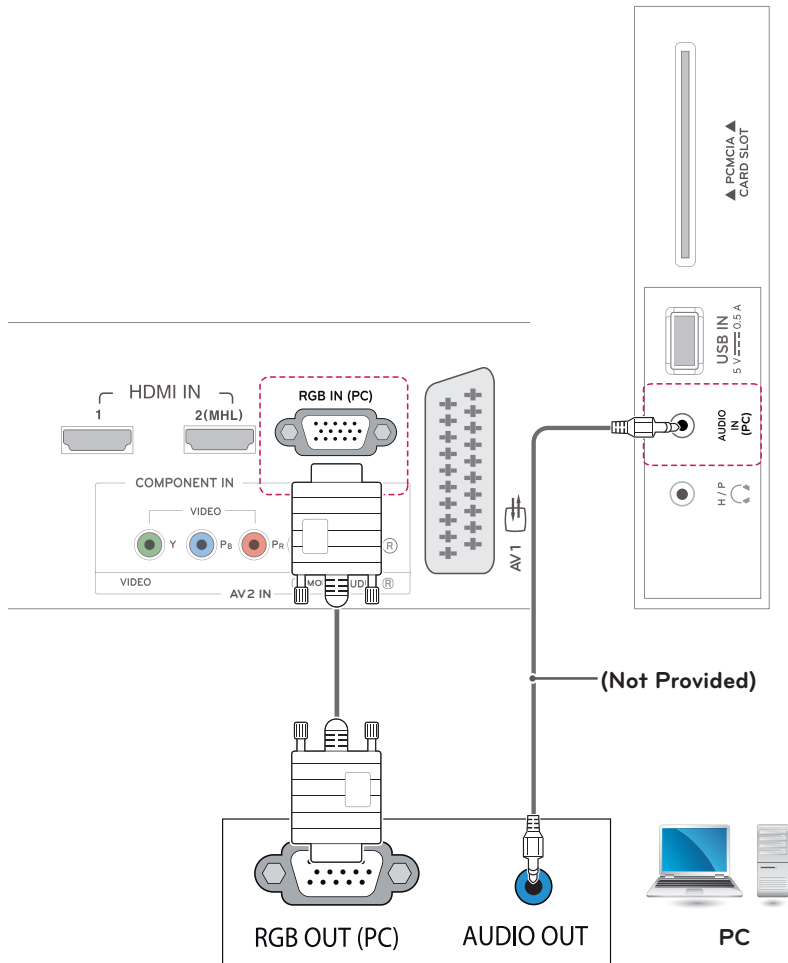



# REMOTE CONTROL

The descriptions in this manual are based on the buttons of the remote control. Please read this manual carefully and use the TV correctly.

To replace batteries, open the battery cover, replace batteries (1.5 V AAA) matching ⊕ and ⊖ ends to the label inside the compartment, and close the battery cover.

To remove the batteries, perform the installation actions in reverse.

**CAUTION**

Do not mix old and new batteries, as this may damage the remote control.

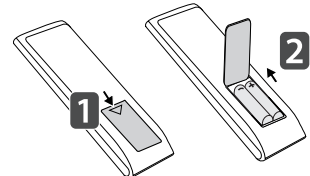

Make sure to point the remote control to the remote control sensor on the TV. Image shown may differ from your TV.

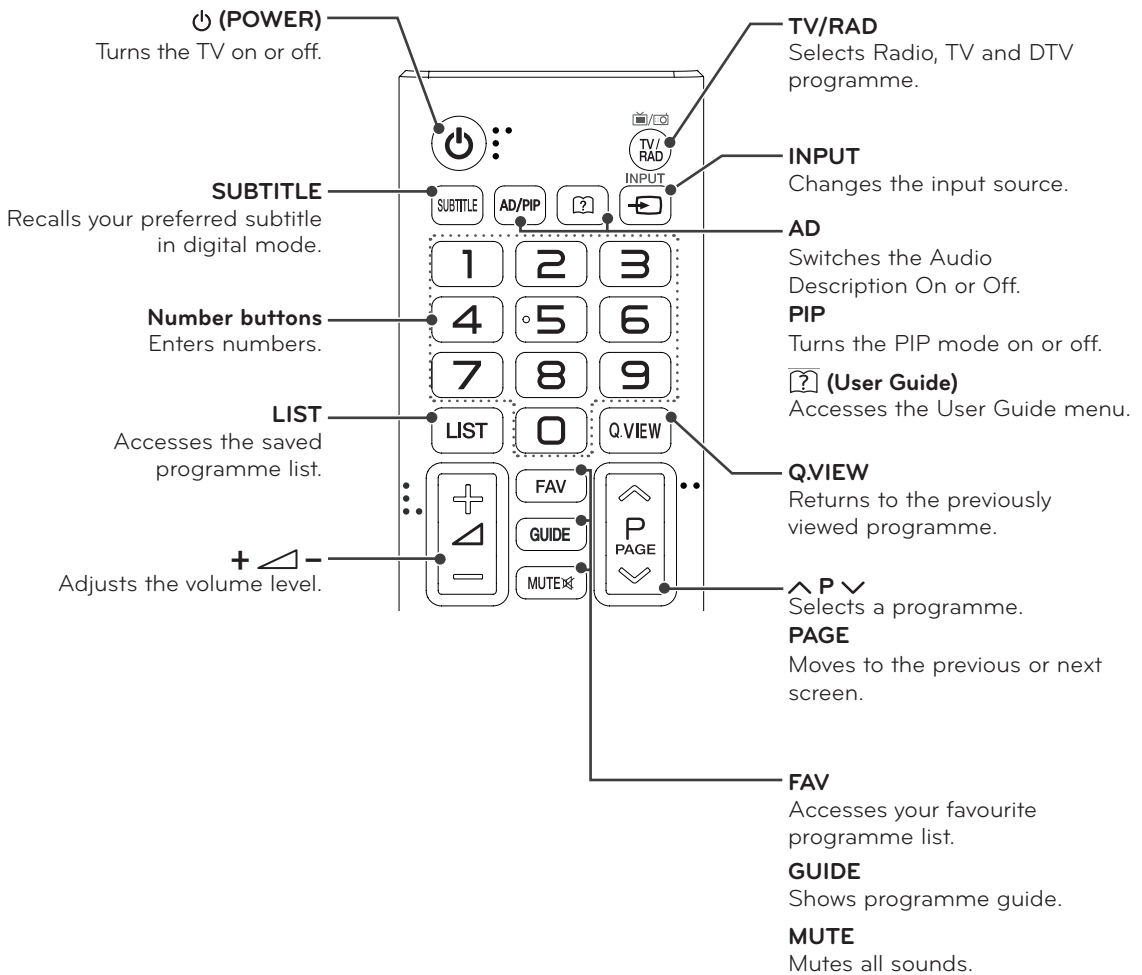

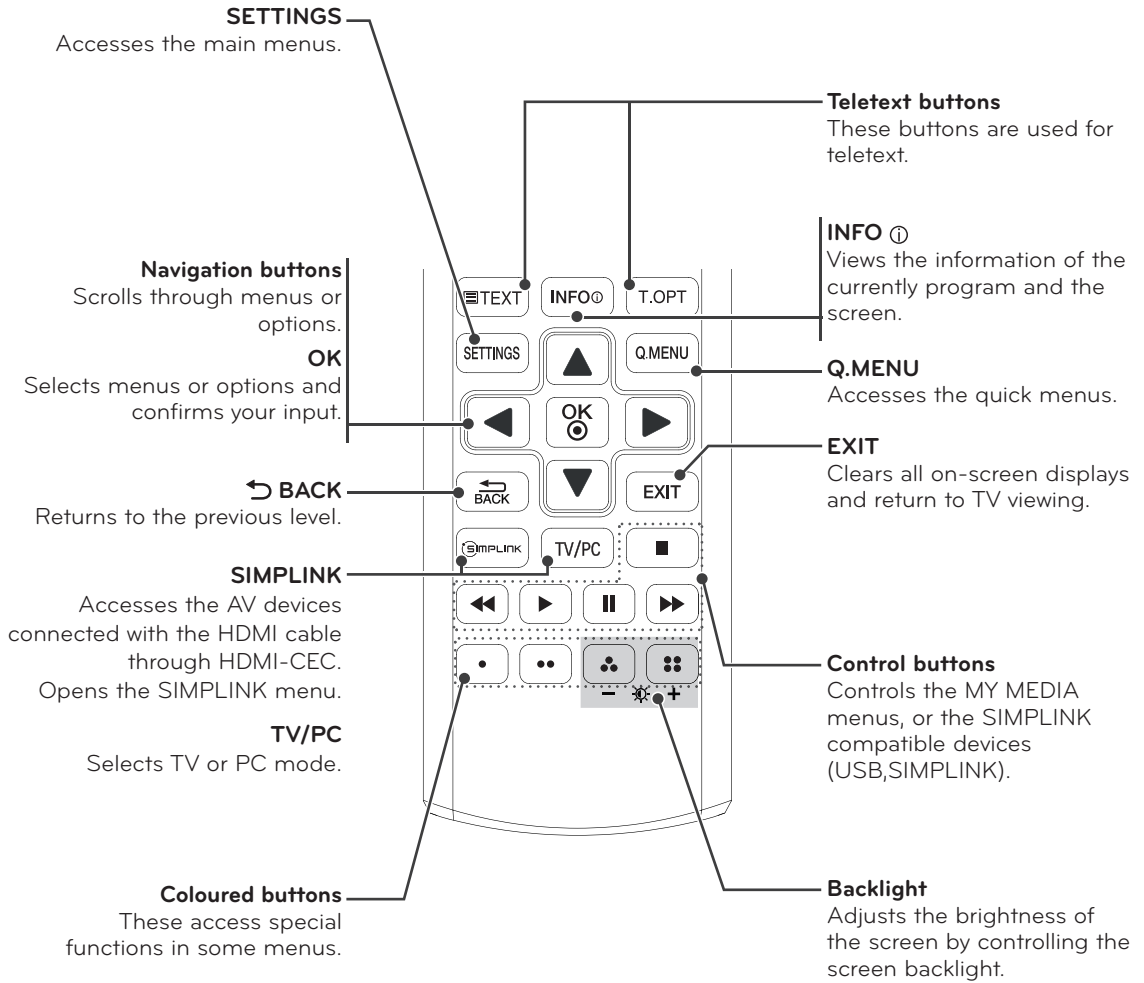

**NOTE**

On MHEG channel, you cannot adjust the backlight with the yellow or blue key.

# CUSTOMIZING SETTINGS

## Accessing main menus

- 1 Press **SETTINGS** to access the main menus.
- 2 Press the Navigation buttons to scroll to one of the following menus and press **OK**.
- 3 Press the Navigation buttons to scroll to the setting or option you want and press **OK**.
- 4 When you are finished, press **EXIT**.  
When you return to the previous menu, press **↶ BACK**.

<b>PICTURE</b>	Adjusts the image size, quality or effect.
<b>AUDIO</b>	Adjusts the sound quality, effect or volume level.
<b>SETUP</b>	Sets up and edit programmes.
<b>TIME</b>	Sets the time, date or Timer feature.
<b>LOCK</b>	Locks or unlocks channels and programs.
<b>OPTION</b>	Customizes the general settings.
<b>INPUT</b>	Views the input sources with their labels.
<b>MY MEDIA</b>	Using integrated media feature.

- Press **RED** button to access the **Customer Support** menus.
- Press **GREEN** Button to access the **FAQ** menus.

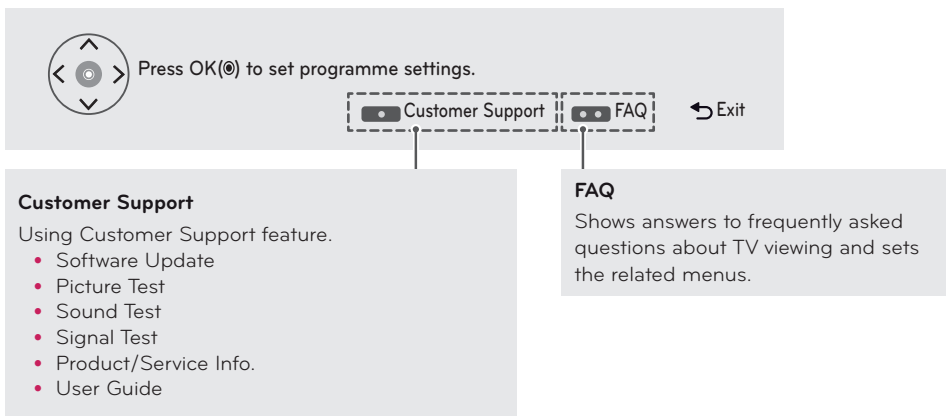

# USING THE USER GUIDE

## Accessing User Guide menu.

### Using the TV menu

- 1 Press **SETTINGS** to access the main menus.
- 2 Press the **RED** button to access the **Customer Support** menus.
- 3 Press the Navigation button to scroll to **User Guide** and press **OK**.
- 4 Press the Navigation buttons to scroll to the option you want and press **OK**.
- 5 When you are finished, press **EXIT**.  
When you return to the previous menu, press **BACK**.

### Using the Remote Control

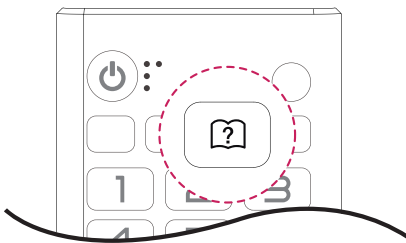

- 1 Press  (**User Guide**) to access the **User Guide**.
- 2 Press the Navigation buttons to scroll to the option you want and press **OK**.
- 3 When you are finished, press **EXIT**.  
When you return to the previous menu, press **BACK**.

- Image shown may differ from your TV.

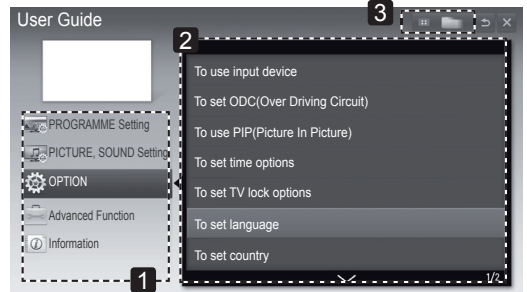

- 1 Allows to select the category you want.
- 2 Allows to select the item you want.  
You can use **^**/**v** to move between pages.
- 3 Allows to browse the description of the function you want from the index.

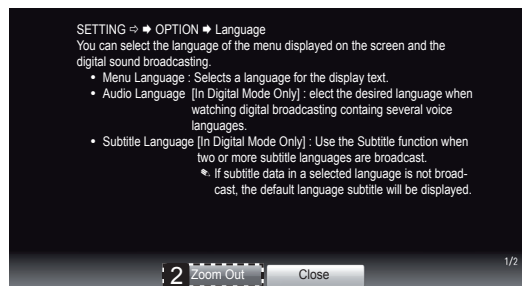
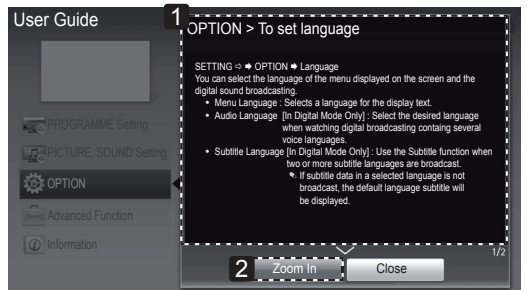

- 1 Shows the description of the selected menu.  
You can use **^**/**v** to move between pages.
- 2 Zooms in or out the screen.

# MAINTENANCE

## Cleaning Your TV

Clean your TV regularly to keep the best performance and to extend the product lifespan.



### CAUTION

- Make sure to turn the power off and disconnect the power cord and all other cables first.
- When the TV is left unattended and unused for a long time, disconnect the power cord from the wall outlet to prevent possible damage from lightning or power surges.

## Screen and frame

To remove dust, wipe the surface with a dry and soft cloth.

To remove major dirt, wipe the surface with a soft cloth dampened in clean water or a diluted mild detergent. Then wipe immediately with a clean and dry cloth.



### CAUTION

- Do not push, rub, or hit the surface with your fingernail or a sharp object, as this may result in scratches on the screen and image distortions.
- Do not use any chemicals, such as waxes, benzene, alcohol, thinners, insecticides, air fresheners, lubricants, as these may damage the screen's finish and cause discolorations.

## Cabinet and stand

To remove dust, wipe the cabinet with a dry and soft cloth.

To remove major dirt, wipe the cabinet with a soft cloth dampened in a clean water or water containing a small amount of mild detergent.



### CAUTION

- Do not spray liquid onto the surface. If water enters the TV, it may result in fire, electric shock, or malfunction.
- Do not use any chemicals as this may deteriorate the surface.

## Power cord

Remove the accumulated dust or dirt on the power cord regularly.

## Preventing "Image burn" or "Burn-in" on your TV screen

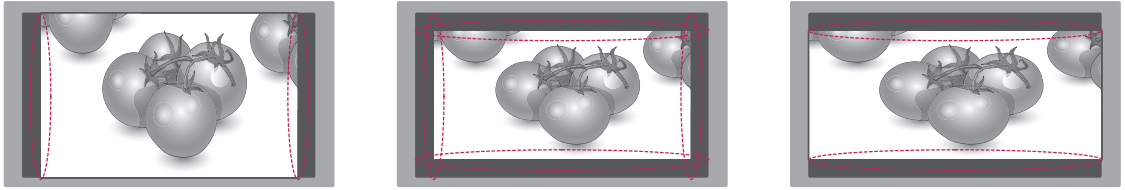

- If a fixed image displays on the TV screen for a long period of time, it will be imprinted and become a permanent disfigurement on the screen. This is "image burn" or "burn-in" and not covered by the warranty.
- If the aspect ratio of the TV is set to 4:3 for a long period of time, image burn may occur on the letterboxed area of the screen.
- Avoid displaying a fixed image on the TV screen for a long period of time (2 or more hours for LCD) to prevent image burn.

# TROUBLESHOOTING

## General

Problem	Resolution
Cannot control the TV with the remote control.	<ul style="list-style-type: none"><li>• Check the remote control sensor on the product and try again.</li><li>• Check if there is any obstacle between the product and the remote control.</li><li>• Check if the batteries are still working and properly installed (⊕ to ⊕, ⊖ to ⊖).</li></ul>
No image display and no sound is produced.	<ul style="list-style-type: none"><li>• Check if the product is turned on.</li><li>• Check if the power cord is connected to a wall outlet.</li><li>• Check if there is a problem in the wall outlet by connecting other products.</li></ul>
The TV turns off suddenly.	<ul style="list-style-type: none"><li>• Check the power control settings. The power supply may be interrupted.</li><li>• Check if the Auto sleep feature is activated in the Time settings.</li><li>• If there is no signal while the TV is on, the TV will turn off automatically after 15 minutes of inactivity.</li></ul>

# SPECIFICATIONS

	Digital TV	Analogue TV
Television system	DVB-T DVB-C	PAL/SECAM B/G/D/K, PAL I/I', SECAM L/L'
Programme coverage	VHF, UHF	VHF: E2 to E12, UHF : E21 to E69, CATV: S1 to S20, HYPER: S21 to S47
Maximum number of storable programmes	1,500	

## 23MA73D

Panel	Screen Type	580 mm Wide (23 inch) Visible diagonal size : 580 mm
	Pixel Pitch	0.265 mm (H) x 0.265 mm (V)
Video Signal	Max. Resolution	1920 × 1080 @ 60 Hz
	Recommended Resolution	1920 × 1080 @ 60 Hz
	Horizontal Frequency	30 kHz to 83 kHz
	Vertical Frequency	56 Hz to 75 Hz
	Synchronization Type	Separate Sync, Digital
Input Connector		TV, D-Sub Analog, AV1(SCART), PC Audio In, Component, AV2(CVBS), HDMI*2, USB, PCMCIA
Power	Rated Voltage	19 V --- 2.4 A
	Power Consumption	On Mode : 35 W (typ.) Off Mode ≤ 0.4 W
AC/DC Adapter		Manufacturer: LG Innotek, Model: PSAB-L101A Manufacturer: Lite-On, Model: PA-1650-64
Tilt	Tilt Range	-5 to 20°
Dimensions (Width x Depth x Height) Weight	With Stand	
	533 mm x 173.4 mm x 399.1 mm 3.7 kg	
	Without Stand	
	533 mm x 72 mm x 325.9 mm 3.2 kg	
Environmental conditions	Operating Temperature	10 °C to 35 °C
	Operating Humidity	20 % to 80 %
	Storage Temperature	-10 °C to 60 °C
	Storage Humidity	5 % to 90 %

Product specifications shown above may be changed without prior notice due to upgrade of product functions.



## 27MA73D

Panel	Screen Type	690 mm Wide (27 inch) Visible diagonal size : 690 mm
	Pixel Pitch	0.3114 mm (H) x 0.3114 mm (V)
Video Signal	Max. Resolution	1920 × 1080 @ 60 Hz
	Recommended Resolution	1920 × 1080 @ 60 Hz
	Horizontal Frequency	30 kHz to 83 kHz
	Vertical Frequency	56 Hz to 75 Hz
	Synchronization Type	Separate Sync, Digital
Input Connector		TV, D-Sub Analog, AV1(SCART), PC Audio In, Component, AV2(CVBS), HDMI*2, USB, PCMCIA
Power	Rated Voltage	19 V --- 2.4 A
	Power Consumption	On Mode : 40 W (typ.) Off Mode ≤ 0.4 W
AC/DC Adapter		Manufacturer: LG Innotek, Model: PSAB-L101A Manufacturer: Lite-On, Model: PA-1650-64
Tilt	Tilt Range	-5 to 20°
Dimensions (Width x Depth x Height) Weight	With Stand	
	622.7 mm x 197.5 mm x 450 mm 5.4 kg	
	Without Stand	
	622.7 mm x 87.2 mm x 377.9 mm 4.9 kg	
Environmental conditions	Operating Temperature	10 °C to 35 °C
	Operating Humidity	20 % to 80 %
	Storage Temperature	-10 °C to 60 °C
	Storage Humidity	5 % to 90 %

Product specifications shown above may be changed without prior notice due to upgrade of product functions.

## RGB (PC) / HDMI (PC) supported mode

Resolution	Horizontal Frequency(kHz)	Vertical Frequency(Hz)
720 x 400	31.468	70.080
640 x 480	31.469	59.940
640 x 480	37.500	75.000
800 x 600	37.879	60.317
800 x 600	46.875	75.000
1024 x 768	48.363	60.004
1024 x 768 Only HDMI(PC)	56.476	70.069
1024 x 768	60.023	75.029
1152 x 864	67.500	75.000
1280 x 720	45.000	60.000
1280 x 800	49.702	59.810
1280 x 1024	63.981	60.020
1280 x 1024	79.976	75.025
1400 x 1050	65.317	59.978
1440 x 900	55.935	59.887
1600 x 900	60.000	60.000
1680 x 1050	64.674	59.883
1680 x 1050	65.290	59.954
1920 x 1080	67.500	60.000

**NOTE**

The optimal display resolution is 1920 X 1080@60Hz. The optimal timing in each mode is vertical frequency 60Hz.

## HDMI (DTV) supported mode

Resolution	Horizontal Frequency(kHz)	Vertical Frequency(Hz)
720 x 480	31.469 31.500	59.940 60.000
720 x 576	31.250	50.000
1280 x 720	37.500	50.000
1280 x 720	44.960 45.000	59.940 60.000
1920 x 1080	33.720 33.750	59.940 60.000
1920 x 1080	28.125	50.000
1920 x 1080	27.000	24.000
1920 x 1080	33.750	30.000
1920 x 1080	56.250	50.000
1920 x 1080	67.430 67.500	59.940 60.000

## Component supported mode

Resolution	Horizontal Frequency(kHz)	Vertical Frequency(Hz)
720 x 480	15.730	59.940
720 x 480	15.750	60.000
720 x 576	15.625	50.000
720 x 480	31.470	59.940
720 x 480	31.500	60.000
720 x 576	31.250	50.000
1280 x 720	44.960	59.940
1280 x 720	45.000	60.000
1280 x 720	37.500	50.000
1920 x 1080	33.720	59.940
1920 x 1080	33.750	60.000
1920 x 1080	28.125	50.000
1920 x 1080	56.250	50.000
1920 x 1080	67.432	59.940
1920 x 1080	67.500	60.000

## Component port connecting information

Component ports on the TV	Y	P <sub>B</sub>	P <sub>R</sub>
	Y	P <sub>B</sub>	P <sub>R</sub>
	Y	B-Y	R-Y
	Y	Cb	Cr
	Y	Pb	Pr

Video output ports on DVD player	Y	P <sub>B</sub>	P <sub>R</sub>
	Y	B-Y	R-Y
	Y	Cb	Cr
	Y	Pb	Pr

**NOTE**

- Avoid keeping a fixed image on the set's screen for prolonged periods of time. The fixed image may become permanently imprinted on the screen. Use a screen saver when possible.
- There may be interference relating to resolution, vertical pattern, contrast or brightness in PC mode. Change the PC mode to another resolution or change the refresh rate to another rate or adjust the brightness and contrast on the menu until the picture is clear. If the refresh rate of the PC graphic card can not be changed, change the PC graphic card or consult the manufacturer of the PC graphic card.
- The synchronization input waveform for Horizontal and Vertical frequencies are separate.
- Connect the signal cable from the RGB output port of the PC to the RGB (PC) port of the TV or the signal cable from the HDMI output port of the PC to the HDMI IN port on the TV.
- Connect the audio cable from the PC to the Audio input on the TV. (Audio cables are not included with the TV).
- If using a sound card, adjust PC sound as required.
- If the graphic card on the PC does not output analogue and digital RGB simultaneously, connect only one of either RGB or HDMI IN to display the PC output on the TV.
- If the graphic card on the PC does output analogue and digital RGB simultaneously, set the TV to either RGB or HDMI. (The other mode is set to Plug and Play automatically by the TV.)
- DOS mode may not work depending on the video card if you use an HDMI to DVI cable.
- If you use too long an RGB-PC cable that is too long, there may be interference on the screen. We recommend using under 5 m of cable. This provides the best picture quality.



Make sure to read the Safety Precautions before using the product. Keep the Owner's Manual (CD) in an accessible place for future reference. The model and serial number of the TV is located on the back and one side of the TV. Record it below should you ever need service.

MODEL \_\_\_\_\_

SERIAL \_\_\_\_\_

To obtain the source code under GPL, LGPL, MPL and other open source licenses, that is contained in this product, please visit <http://opensource.lge.com>.

In addition to the source code, all referred license terms, warranty disclaimers and copyright notices are available for download. LG Electronics will also provide open source code to you on CD-ROM for a charge covering the cost of performing such distribution (such as the cost of media, shipping and handling) upon email request to [opensource@lge.com](mailto:opensource@lge.com). This offer is valid for three (3) years from the date on which you purchased the product.