



LG

Life's Good

ENGLISH

OWNER'S MANUAL

MONITOR SIGNAGE

Please read this manual carefully before operating your set and retain it for future reference.

MONITOR SIGNAGE MODELS

47WV30MS

47WV30BR

47WV30BS

47WV30-BAAM

47WV30-BAAL

www.lg.com

CONTENTS

4 LICENSE

5 ASSEMBLING AND PREPARING

- 5 Unpacking
- 6 Parts
- 7 To install in a Portrait Layout
- 7 Remove L-brackets before Installation
- 8 Moving Handles
 - 8 - Moving the device in a vertical position
 - 8 - Moving the device in a horizontal position
- 9 STORAGE METHOD FOR PANEL PROTECTION
 - 9 - Correct Method
 - 9 - Incorrect Method
- 10 Installing on a wall
- 11 EXTERNAL EQUIPMENT SETUP
 - 11 - IR RECEIVER
- 12 Tiling Displays
 - 12 - How to Join Sets - Installing Set 1
 - 13 - How to Join Sets - Installing Set 2
 - 14 - How to Join Sets - Installing Set 3
 - 15 - How to Join Sets - Installing Set 4
- 16 Inserting the Cable Holder

17 REMOTE CONTROL

- 19 Displaying the device name connected to an input port
- 20 Picture ID

21 USING THE MONITOR SET

- 21 Connecting to a PC
 - 21 - RGB connection
 - 22 - DVI connection
 - 22 - HDMI connection
 - 23 - Audio connection

- 23 - IR Receiver connection
- 24 Adjusting the screen
 - 24 - Selecting an image mode
 - 24 - Customizing image options
- 25 - Customizing PC display options
- 25 Adjusting the sound
 - 25 - Selecting a sound mode
 - 26 - Customizing sound options
- 26 Using additional options
 - 26 - Adjusting aspect ratio

28 ENTERTAINMENT

- 28 - Connecting to a wired network
- 29 - Network Status
- 30 - Connecting USB storage devices
- 31 - Browsing files
- 32 - Viewing movies
- 36 - Viewing photos
- 39 - Listening to music
- 41 - DivX® VOD Guide

43 CUSTOMIZING SETTINGS

- 43 Accessing main menus
- 44 - PICTURE settings
- 47 - AUDIO settings
- 48 - TIME settings
- 49 - OPTION settings
- 53 - NETWORK settings

54 MAKING CONNECTIONS

- 55 Connecting to a HD receiver, DVD or VCR player
 - 55 - HDMI connection
 - 55 - DVI - HDMI connection
 - 56 - Component connection
 - 56 - AV connection (Only 47WV30BR and 47WV30MS)

- 57 Connecting to the LAN
- 57 - LAN connection
- 57 Connecting to a USB
- 58 Daisy Chain Monitors
- 58 - RGB Cable
- 58 - DVI Cable

59 TROUBLESHOOTING

62 SPECIFICATIONS

64 RS-232 CONTROL

NOTE

- The following three phenomena may occur due to the characteristics of the Super Narrow Bezel LCD. They are not related to the display's performance.
 1. The edges of the screen may become darker or shadows may appear.
 2. Light leakage may occur depending on the viewing angle.
 3. Some components such as the guide boss or clip may be visible on the edges of the screen.

LICENSE

A different license is supported depending on the model. Visit www.lg.com for more information on the license.



HDMI, the HDMI logo and High-Definition Multimedia Interface are trademarks or registered trademarks of HDMI Licensing LLC.



ABOUT DIVX VIDEO: DivX® is a digital video format created by DivX, LLC, a subsidiary of Rovi Corporation. This is an official DivX Certified® device that plays DivX video. Visit divx.com for more information and software tools to convert your files into DivX videos.

ABOUT DIVX VIDEO-ON-DEMAND: This DivX Certified® device must be registered in order to play purchased DivX Video-on-Demand (VOD) movies. To obtain your registration code, locate the DivX VOD section in your device setup menu. Go to vod.divx.com for more information on how to complete your registration.

DivX Certified® to play DivX® video up to HD 1080p, including premium content.

DivX®, DivX Certified® and associated logos are trademarks of Rovi Corporation or its subsidiaries and are used under license.

Covered by one or more of the following U.S. patents: 7,295,673; 7,460,668; 7,515,710; 7,519,274



Manufactured under license from Dolby Laboratories. “Dolby” and the double-D symbol are trademarks of Dolby Laboratories.

ASSEMBLING AND PREPARING

Unpacking

Check your product box for the following items. If there are any missing accessories, contact the local dealer where you purchased your product. The illustrations in this manual may differ from the actual product and accessories.

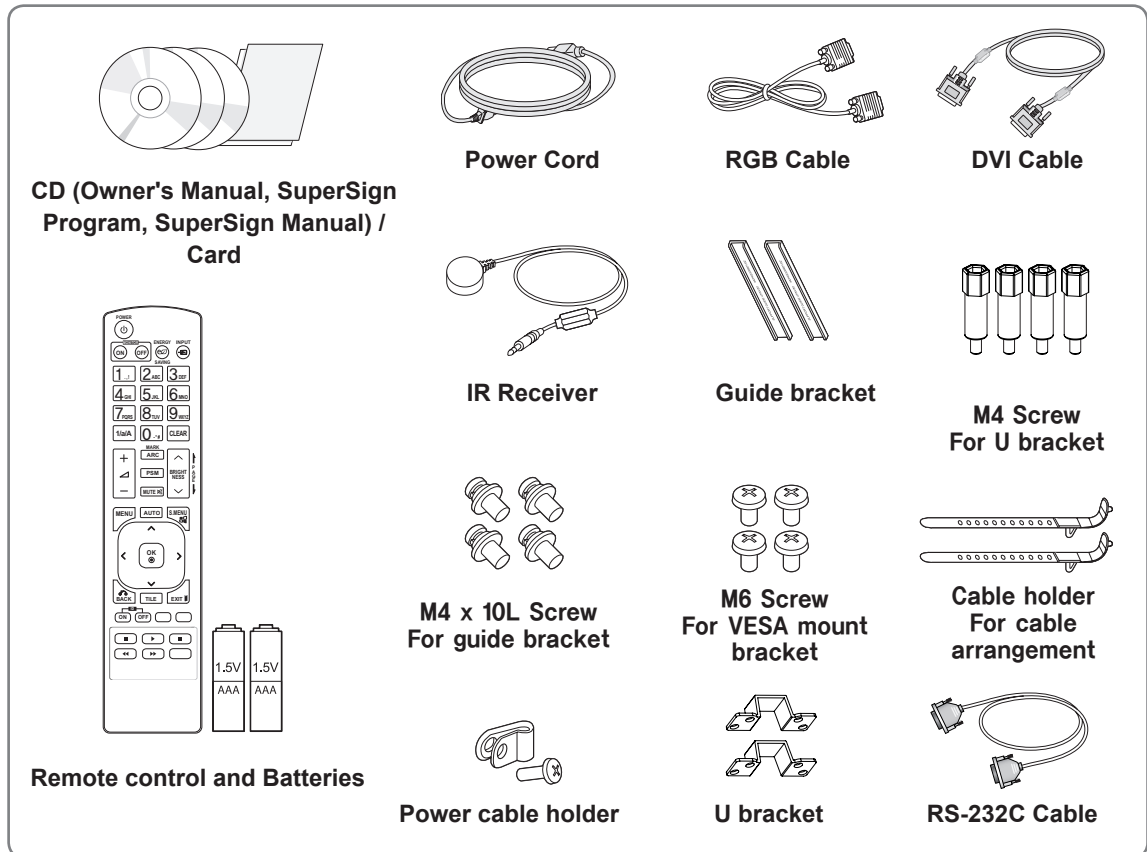

CAUTION

- Do not use any pirated items to ensure the safety and product life span.
- Any damages or injuries by using pirated items are not covered by the warranty.



NOTE

- The accessories supplied with your product may vary depending on the model.
- Product specifications or contents in this manual may be changed without prior notice due to upgrade of product functions.

Parts

< 47WV30MS/47WV30BR >

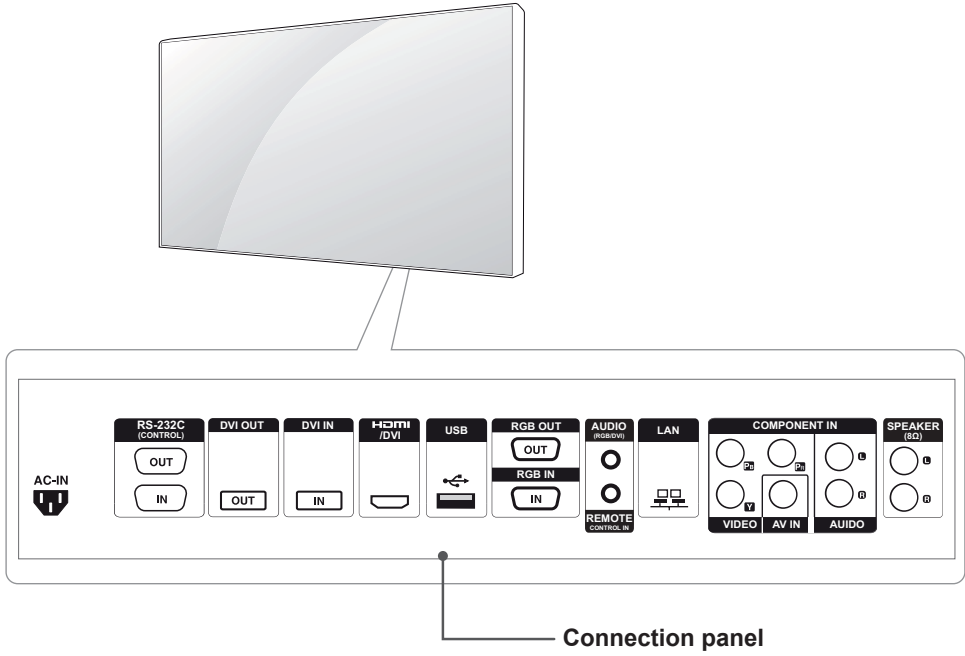

< 47WV30BS/47WV30-BAAM/47WV30-BAAL >

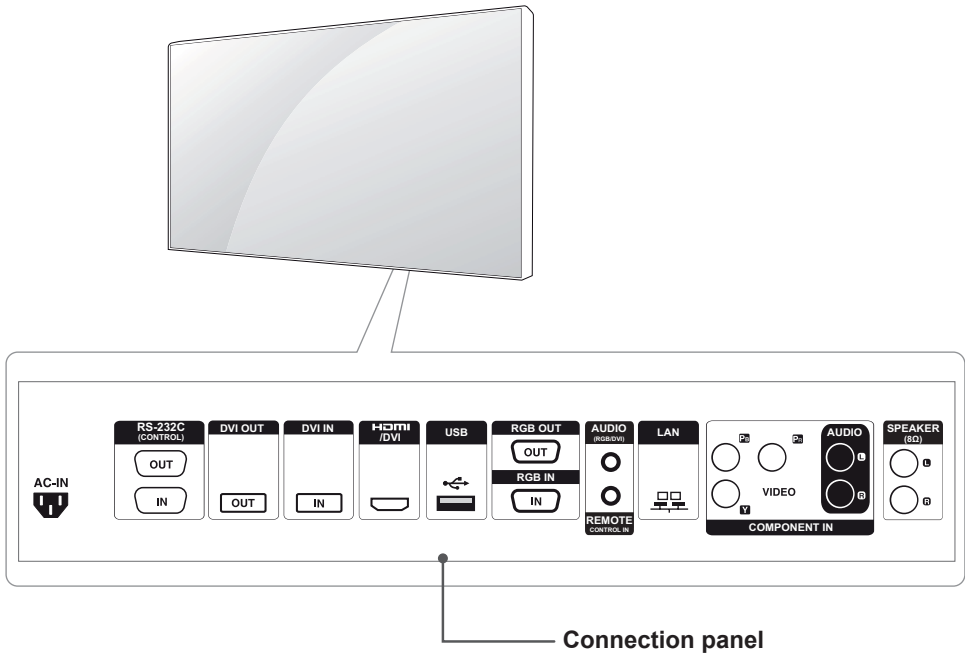

To install in a Portrait Layout

When installing in a Portrait Layout, rotate the monitor clockwise 90 degrees (when facing the screen).

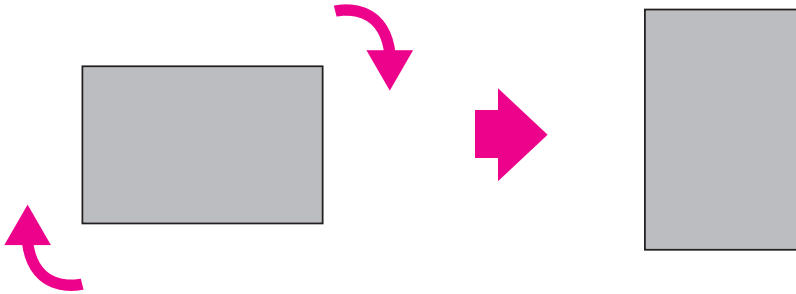

Remove L-brackets before Installation

Remove the L-brackets from each corner of the monitor before installing it.

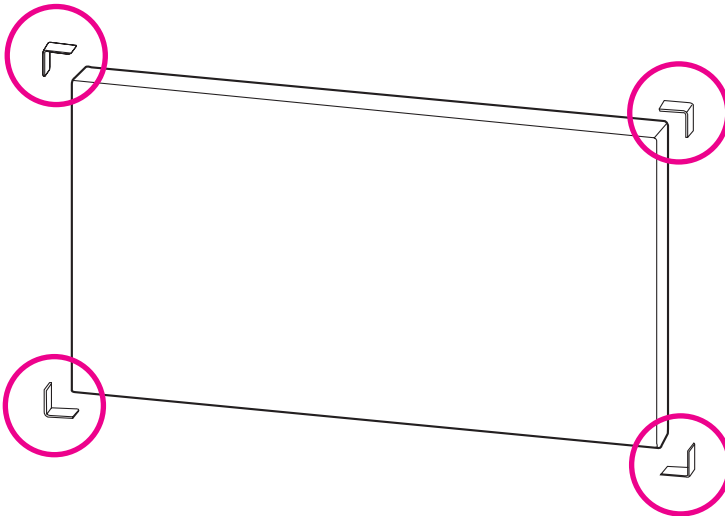

! NOTE

Keep the removed L-brackets and use them when moving the monitor later.

Moving Handles

Moving the device in a vertical position

Hold the vertical handles on the left and right sides or the left and right handles on the back of the display.

Moving the device in a horizontal position

Have the screen facing down and hold the vertical handles on the left and right sides.

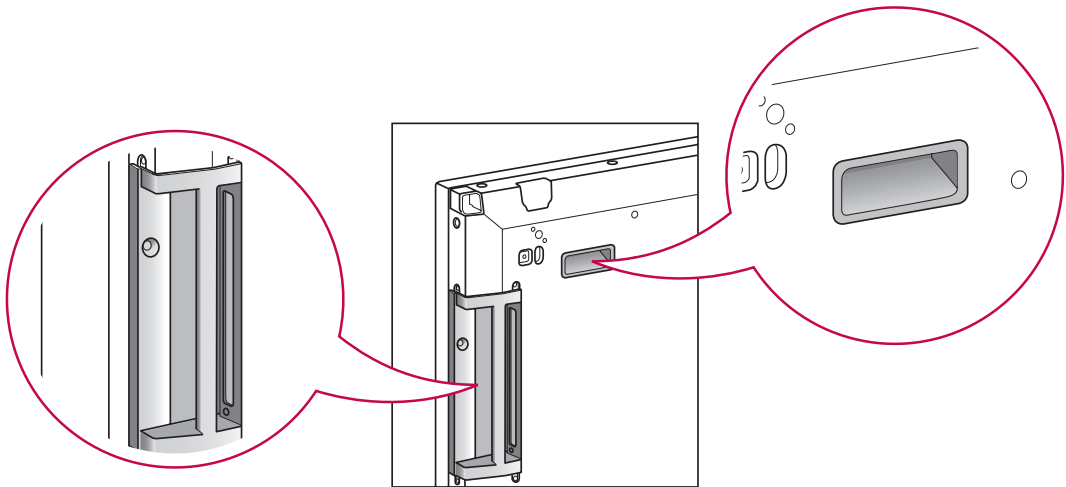
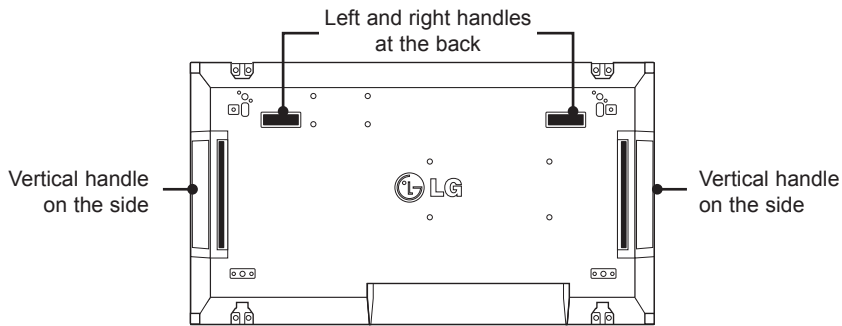

CAUTION

- Be careful not to directly touch the panel or expose it to shock when moving the monitor.
- Hold the monitor with the handles as the corners of the front panel are sharp, which may cause an injury.

STORAGE METHOD FOR PANEL PROTECTION

Correct Method

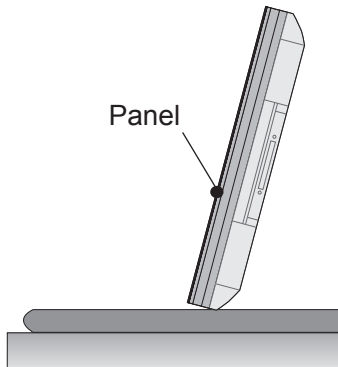

If the product needs to be set upright, hold both sides of the product, and tilt backward carefully for. Do not let the panel touch the floor.

Incorrect Method

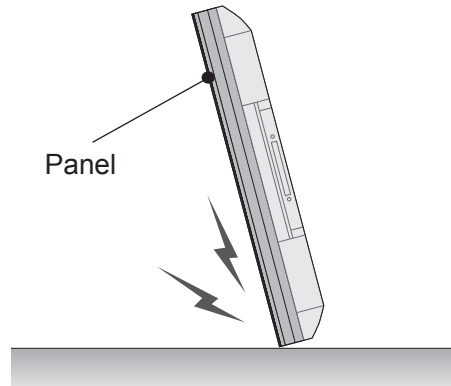

If the product is tilted onto the bezel, the bottom of the panel may be damaged.

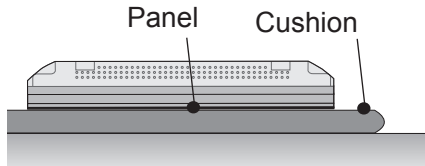

When laying down the product, lay a cushion on a flat floor. Put the product on it with the panel of the product facing down.

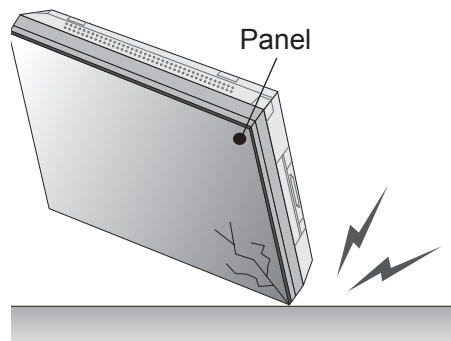

If the product is tilted onto the edge of the panel, the panel may be damaged.

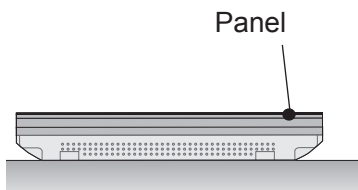

If there is not a cushion available, ensure the floor is clean and then lay the product down carefully with the panel facing either upward or downward. At this time, be careful for objects not to fall on the panel.

Installing on a wall

Install the monitor at least 10 cm away from the wall and leave about 10 cm of space at each side of the monitor to ensure sufficient ventilation. Detailed installation instructions can be obtained from your local retail store. Please refer to the manual to install and set up a tilting wall mounting bracket.

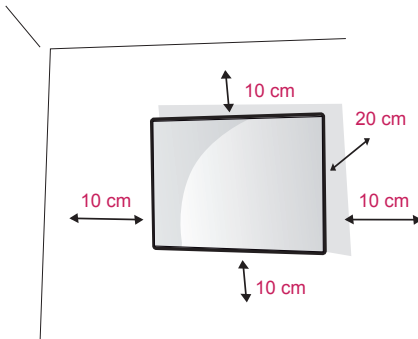

If you want to mount the monitor on the wall (optional), attach the wall mounting bracket to the rear of the monitor.

Make sure that the wall mounting bracket is securely fixed to the monitor and to the wall.

Use the wall mount plate and screws that comply with the VESA standard.

Use the wall mount plate and screws conforming to the VESA standard.

! NOTE

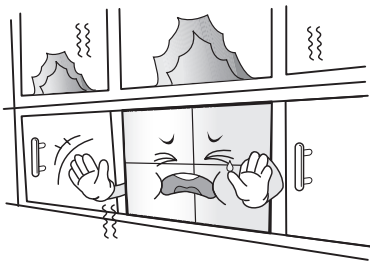

- Do not install the product in a place with no ventilation (e.g., on a bookshelf or in a closet) or on a carpet or cushion. If there is no other option but to mount the product on the wall, make sure that sufficient ventilation is provided before installation.
 - Failure to do so may result in a fire due to the increase in the internal temperature.

! CAUTION

- Disconnect the power cord first, and then move or install the Monitor set. Otherwise electric shock may occur.
- If you install the Monitor set on a ceiling or slanted wall, it may fall and result in severe injury. Use an authorized LG wall mount and contact the local dealer or qualified personnel.
- Do not over tighten the screws as this may cause damage to the Monitor set and void your warranty.
- Use the screws and wall mounts that meet the VESA standard. Any damages or injuries by misuse or using an improper accessory are not covered by the warranty.

! NOTE

- Use the screws that are listed on the VESA standard screw specifications.
- The wall mount kit includes an installation manual and necessary parts.
- The wall mount bracket is optional. You can obtain additional accessories from your local dealer.
- The length of screws may differ depending on the wall mount. Be sure to use the proper length.
- For more information, refer to the instructions supplied with the wall mount.

EXTERNAL EQUIPMENT SETUP

IR RECEIVER

This allows a remote control sensor to be placed in a custom location. Then that display can control other displays via an RS-232 cable. Refer to page 19 for more information.

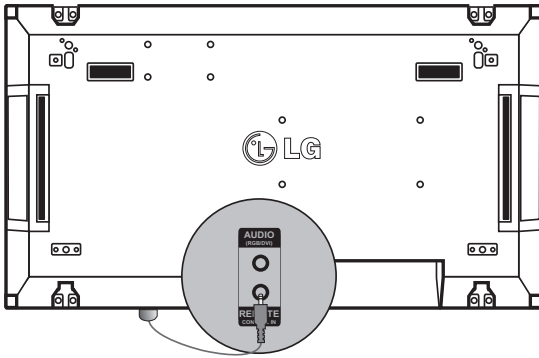

Tiling Displays

How to Join Sets - Installing Set 1

*Example of 2 x 2 tiling

* The numbers assigned in this example (#1, #2, #3, #4) are used to demonstrate the installation procedure to ensure it is easy to follow. These numbers have nothing to do with the Set ID that is used to operate the remote control. Set the guide bracket into the bracket groove using screws and mount the set to the wall mount plate or the wall.

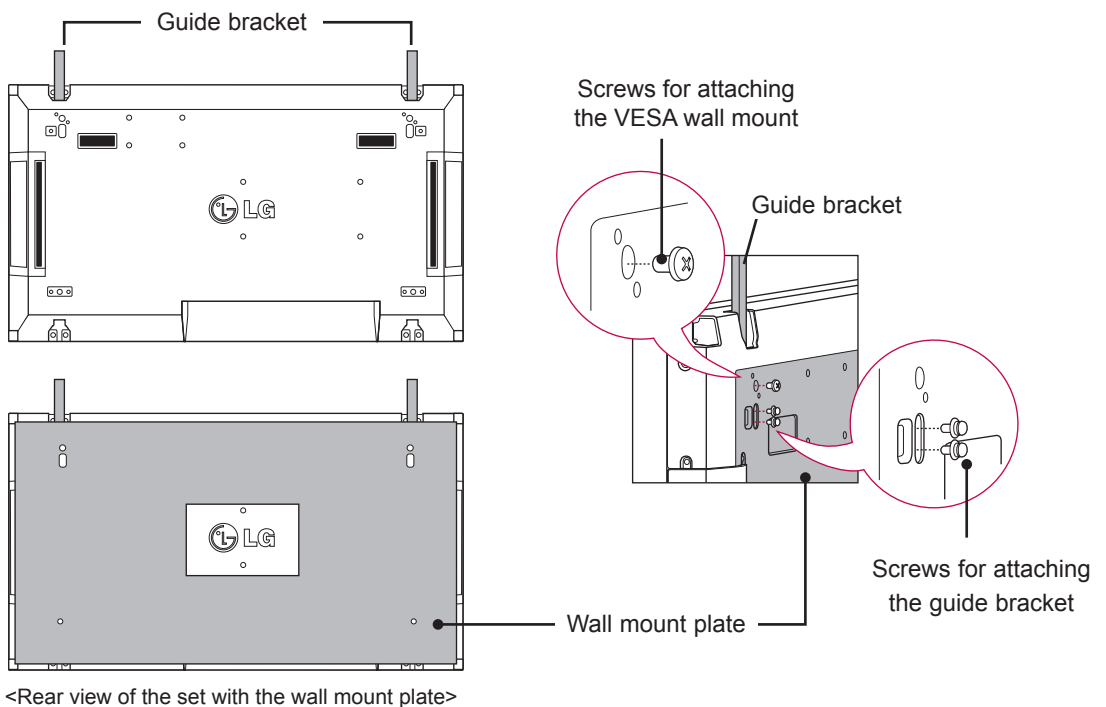

* The wall mount plate is shaded in gray in the illustration to help you see it.

How to Join Sets - Installing Set 2

Join Set 2 to Set 1 using the guide brackets on the top side of Set 1 and mount the two sets to the wall mount plate or the wall.

Remove the guide brackets after mounting the sets.

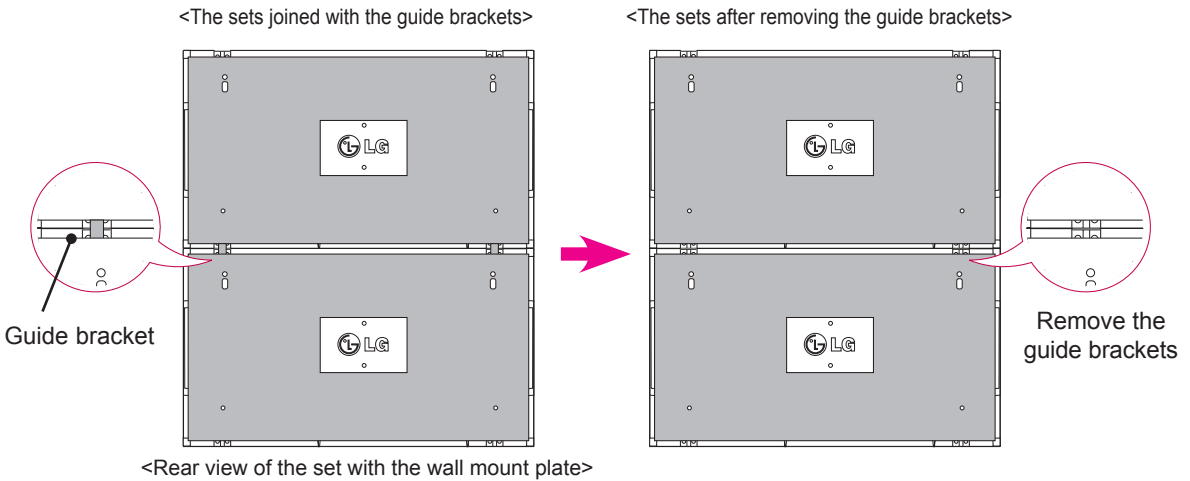

How to remove the guide brackets

- * Unscrew the guide bracket screws from the rear of the set and remove the guide brackets.
- * Once the screws are removed, the guide brackets will drop. You need to remove them through the gap on the sides of the set.
- * This can be done only when there is enough space between the set and the wall mount plate or the wall to unscrew the screws. (Please check whether there is enough space to remove the screws before fixing the guide brackets.)

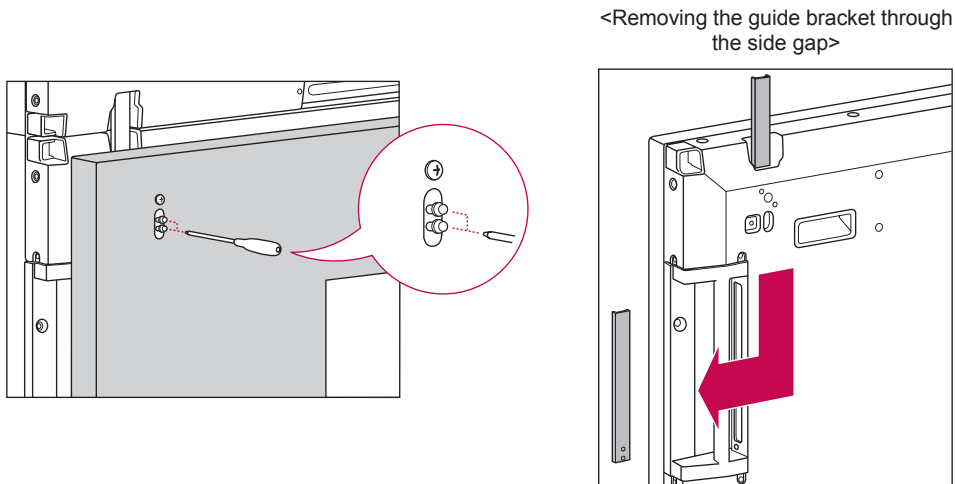

How to Join Sets - Installing Set 3

Fix the guide brackets to Set 3 following the steps above, and loosely mount the set to the wall mount plate or the wall.

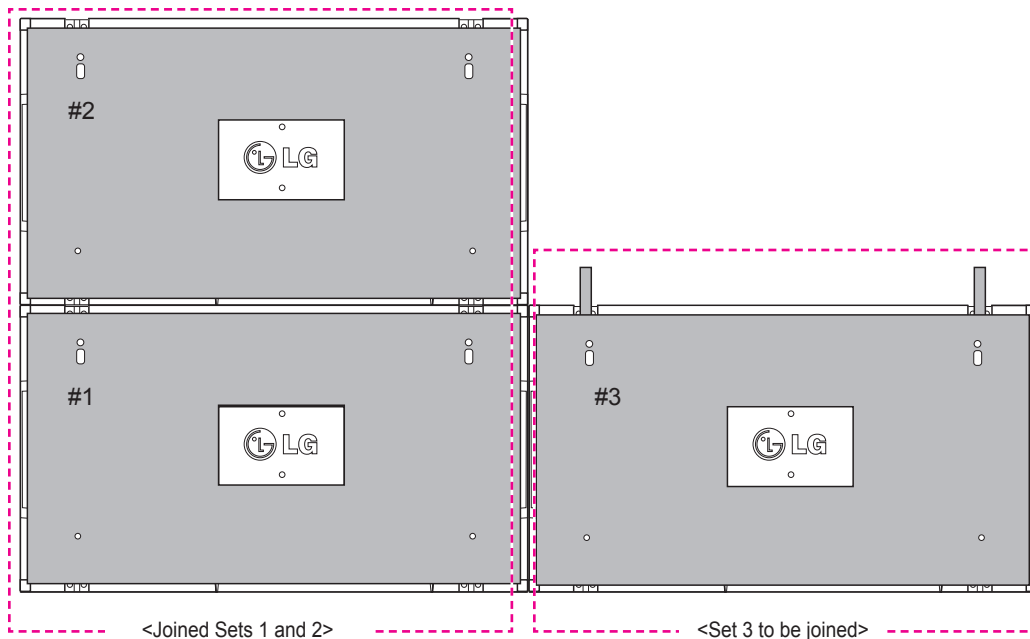

Minimize the space between the sides of the sets using the U-shaped fixture. Fix the 2 sets using the provided screws. At this point, make sure to minimize the space between them. Use a hex head wrench for fixing the screws.

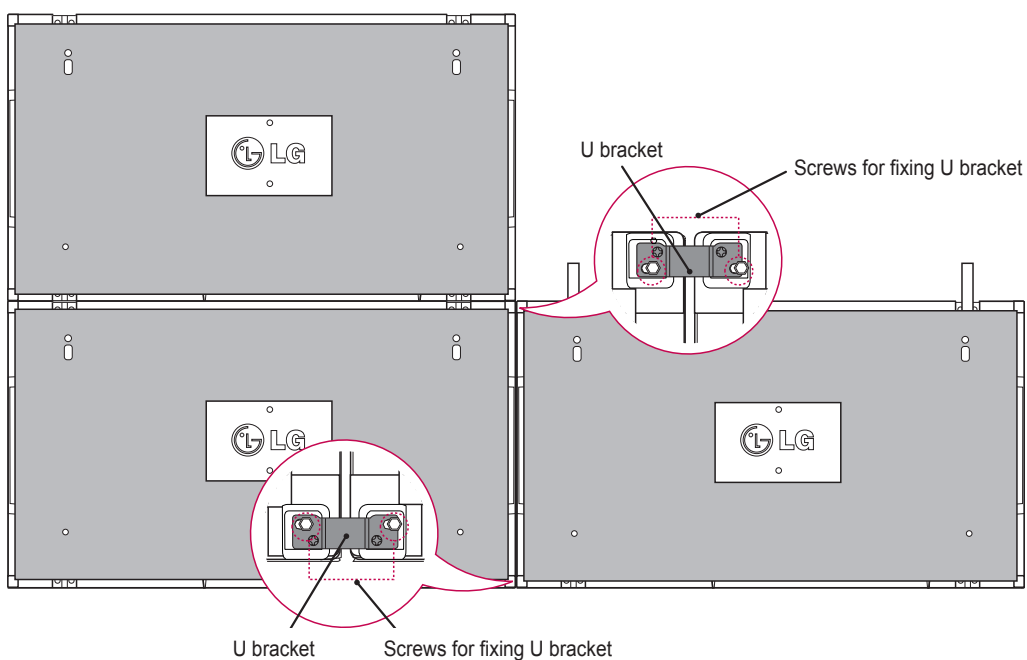

How to Join Sets - Installing Set 4

Loosely mount Set 4 to the wall mount plate or the wall and minimize the space between the sets using the U-shaped fixtures.

When Set 4 is firmly mounted to the wall, remove the U-shaped fixtures. Remove the guide brackets. See <How to Join Sets - Installing Set2,3>.

Now the 2 x 2 tiling is complete.

You can tile in various combinations, such as 3 x 3.

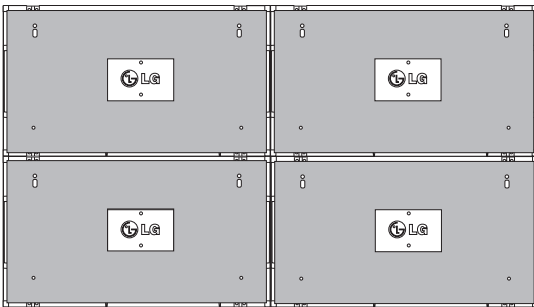

Set 4 joined to the rest of the sets
(2 x 2 tiling)

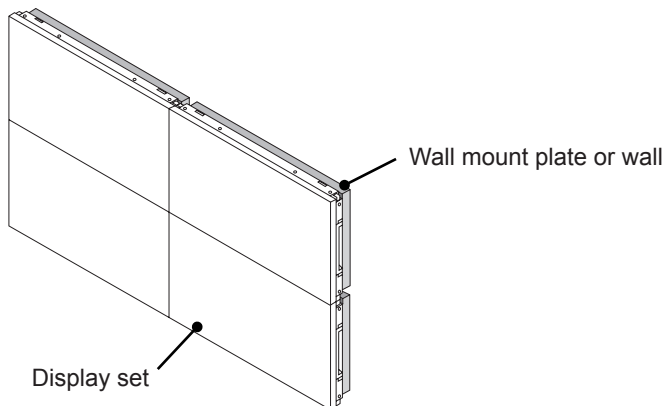

! NOTE

- The guide brackets for tiling should only be used to join sets and should be removed once they are joined.
- The guide brackets should only be used as the assisting tool when tiling sets. The load applied to each set should be supported by the wall mount plate or the wall using a VESA wall mount (800 x 400).
- The guide bracket is used as a guide only, when joining each set. The load applied to each set should be supported by the wall mount plate using a VESA wall mount. (Each set must be firmly mounted to the wall mount plate or the wall.)
- The guide brackets must be removed once the sets are joined. When joining the sets without removing the guide brackets, extra caution is required to prevent damage due to the set weight.
- You may mount the set without using the guide brackets or the U-shaped fixtures; this does not affect the performance of the device.

Inserting the Cable Holder

As illustrated, insert two cable holders into the holes at the bottom rear of the set to organize the cable bundles.

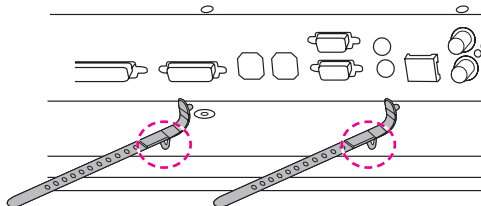

As illustrated, screw the power cable holder into the hole on the bottom rear of the set to hold the power cables together. (This is to put the power cables inside the holder.)

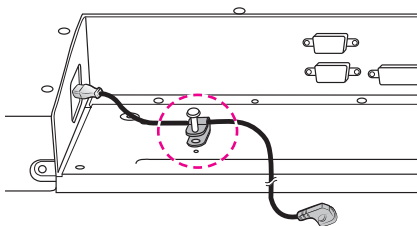

REMOTE CONTROL

The descriptions in this manual are based on the buttons of the remote control. Please read this manual carefully and use the Monitor set correctly.

To replace batteries, open the battery cover, replace batteries (1.5 V AAA) matching ⊕ and ⊖ ends to the label inside the compartment, and close the battery cover. To remove the batteries, perform the installation actions in reverse.

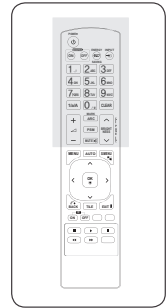
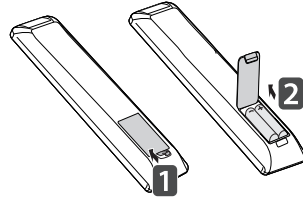

CAUTION

- Do not mix old and new batteries, as this may damage the remote control.
- Make sure to point the remote control at the remote control sensor on the Monitor.

Make sure to point the remote control to the remote control sensor on the Monitor set.

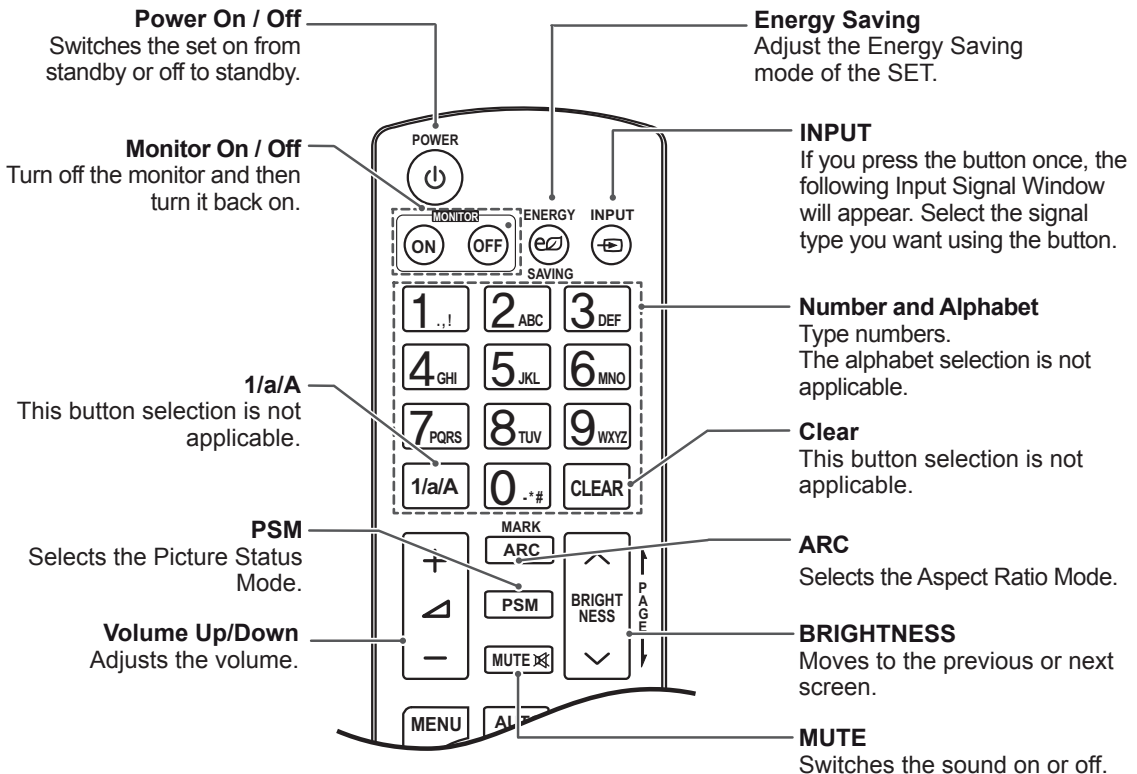

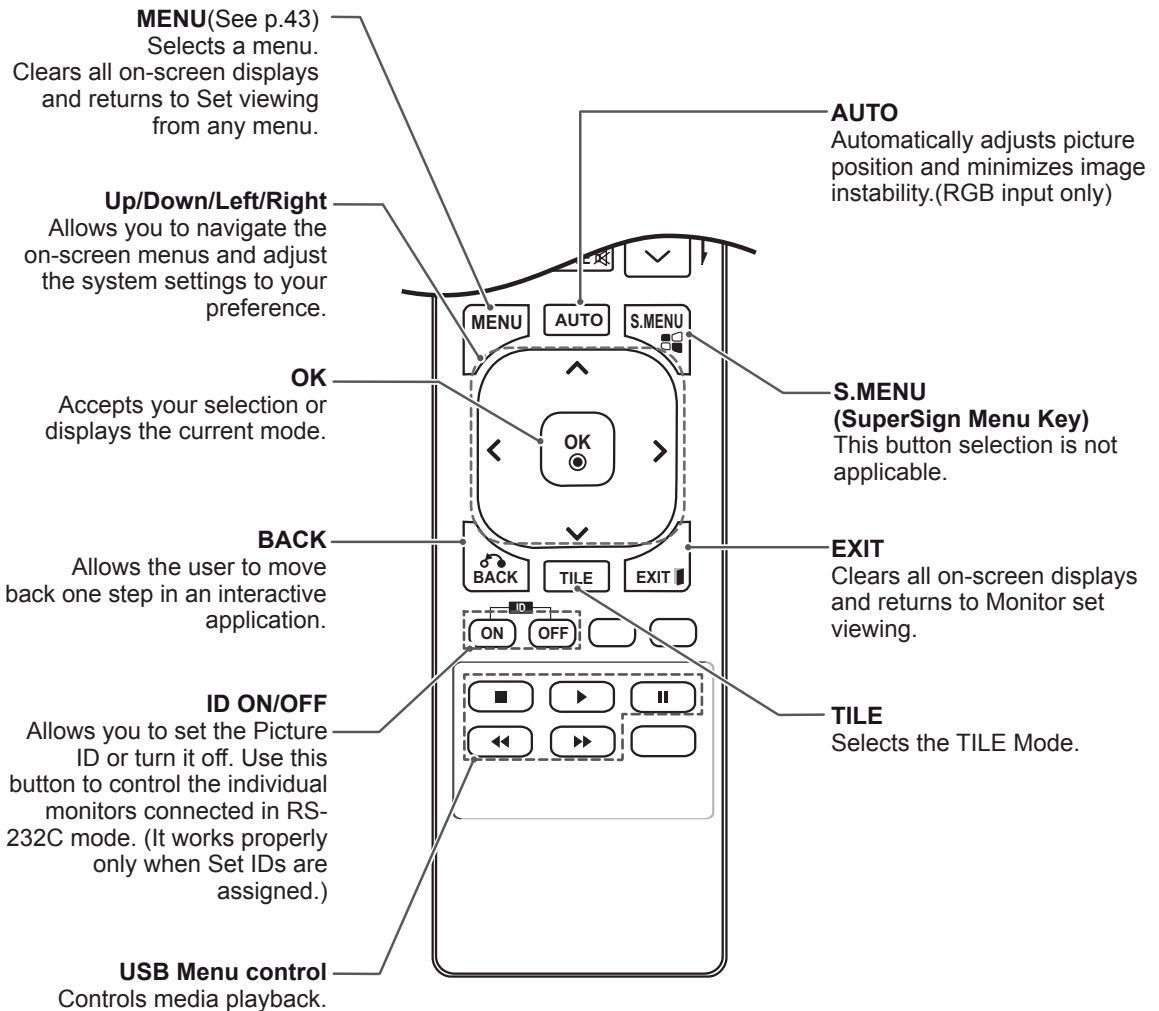
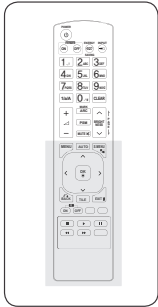

Displaying the device name connected to an input port

Display which devices are connected to which external input ports.

- 1 Access the Input list screen and press the blue (input label) button on the remote control.

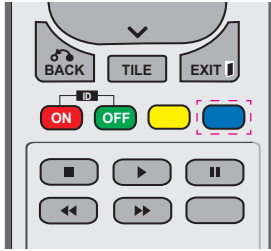

- 2 You can assign an input label for every input except USB.

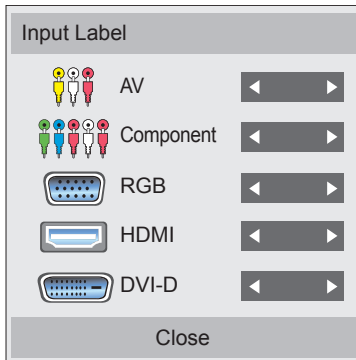

! NOTE

- External inputs supported: AV, Component, RGB, HDMI, DVI-D. (AV only support 47WV-30BR and 47WV30MS)
- Labels available : VCR, DVD, Set top box, Satellite, Game, PC, Blue-ray, HD-DVD
- The input labels are displayed on the Input Label screen or at the top left of the screen when you change the external input setting.
- For DTV/PC-compatible signals, such as 1080p 60 Hz, the screen settings may change according to the input label. The Just Scan option is available if a PC is connected as an external device. (1080p only support 47WV30BR and 47WV30MS)
- 47WV30-BAAL/47WV30-BAAM/47WV30BS does not support AV input.

Picture ID

Picture ID is used to change the settings of a specific set (display) using a single IR receiver for multi-vision. The set receiving the IR signal communicates with another set via the RS232C connector. Each set is identified by a Set ID. If you assign the Picture ID using the remote control, only displays with the same Picture ID and Set ID can be controlled remotely.

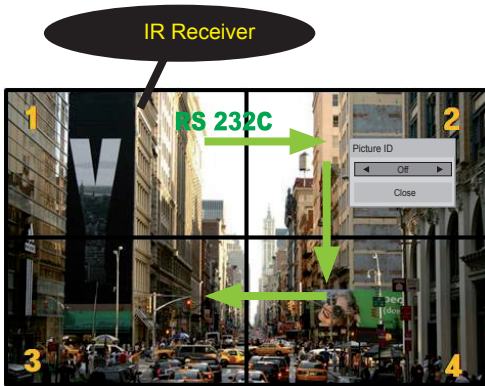
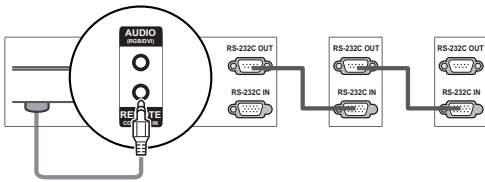

2X2 Multi-Vision (Total Set ID: 4)
Set IDs are assigned as shown in the picture.

1 Press the ID On (Red) button on the remote control.

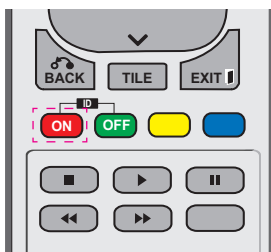

2 If you press the left/right buttons or press the ON button repeatedly, the Picture ID cycles through OFF and 1 to 4. Assign the ID you want.

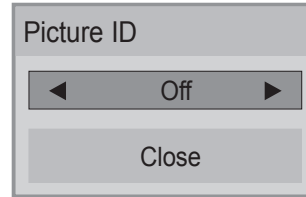

- If you assign the Set ID to each set with multi-vision, and then assign the Picture ID using the red button on the remote control, the key command is displayed for the set with the same Set ID and Picture ID. A set with different Set IDs and Picture IDs cannot be controlled by IR signals.
- The maximum value of the Picture ID can be set in the Total Set ID menu.
- Please refer to the Installation Manual for more information on the assignment of a Total Set ID.

NOTE

- For example, if the Picture ID is assigned to 2, the upper right display (Set ID: 2) can be controlled by IR signals.
- For each set, you can change the settings for the PICTURE, AUDIO, TIME, OPTION, NETWORK and MY MEDIA menus or the hot keys on the remote control.
- If you press the ID OFF (Green) button, the Picture IDs for all sets are turned off. If you then press any button on the remote control, all sets will start working again.
- The Picture ID function may not work during MY MEDIA operating.

USING THE MONITOR SET

Connecting to a PC

NOTE

- It is recommended to you use an HDMI connection for the best image quality.

CAUTION

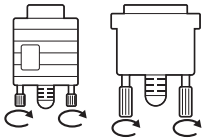

- Connect the signal input cable and tighten it by turning the screws clockwise.

RGB connection

Transmits an analog video signal from your PC to the Monitor set. Connect the PC and the Monitor set with the D-sub 15 pin cable as shown the following illustrations. Select RGB input source on the monitor.

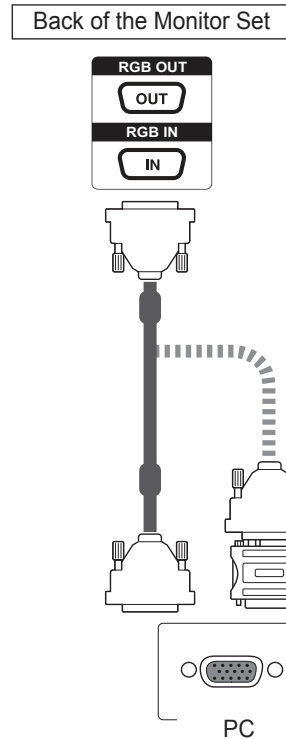

NOTE

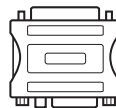

- Apple computers may require an adapter to connect to this monitor. Call or visit their web site for more information.

CAUTION

- Do not press the screen with your finger for it may damage the screen.
- Avoid displaying a fixed image on the screen for a long period of time to prevent image burn. Use a screensaver if possible.

DVI connection

Transmits the digital video signal from your PC to the Monitor set. Connect the PC and the Monitor set with the DVI cable as shown the following illustrations.

Select DVI-D input source on the monitor.

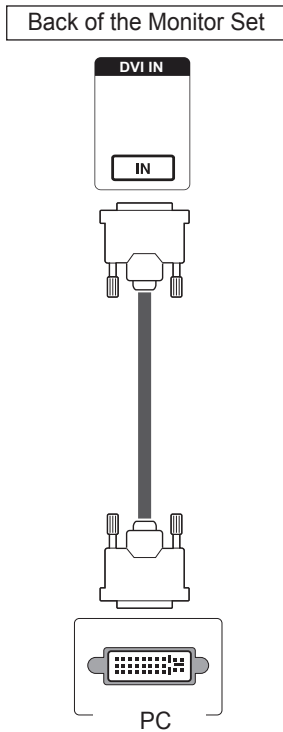

HDMI connection

Transmits the digital video and audio signals from your PC to the Monitor set. Connect the PC and the Monitor set with the HDMI cable as shown in the following illustrations. Select HDMI input source on the monitor.

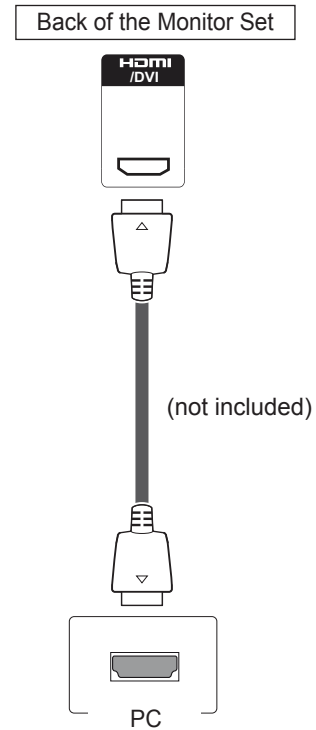

! NOTE

- If you do not use an optional external speaker, connect the PC to the Monitor set with audio cable.
- Use a shielded signal interface cable, such as D-sub 15 pin signal cable and DVI to HDMI cable, with a ferrite core to maintain standard compliance for the product.
- If you want to use HDMI-PC mode, you must set the input label to PC mode.

! NOTE

- Use a High Speed HDMI™ Cable.
- Please check the PC environment if you cannot hear the sound in HDMI mode.
- If you want to use HDMI-PC mode, you must set the input label to PC mode.
- It may not be compatible if you use HDMI-PC mode.

Audio connection

Transmits the audio signals from your PC to the Monitor set. Connect the PC and the Monitor set with the Audio cable as shown in the following illustrations. You should set PC as an input label to connect the PC to the Monitor set with an Audio connection.

IR Receiver connection

Allows the use of a wired remote or IR receiver extension.

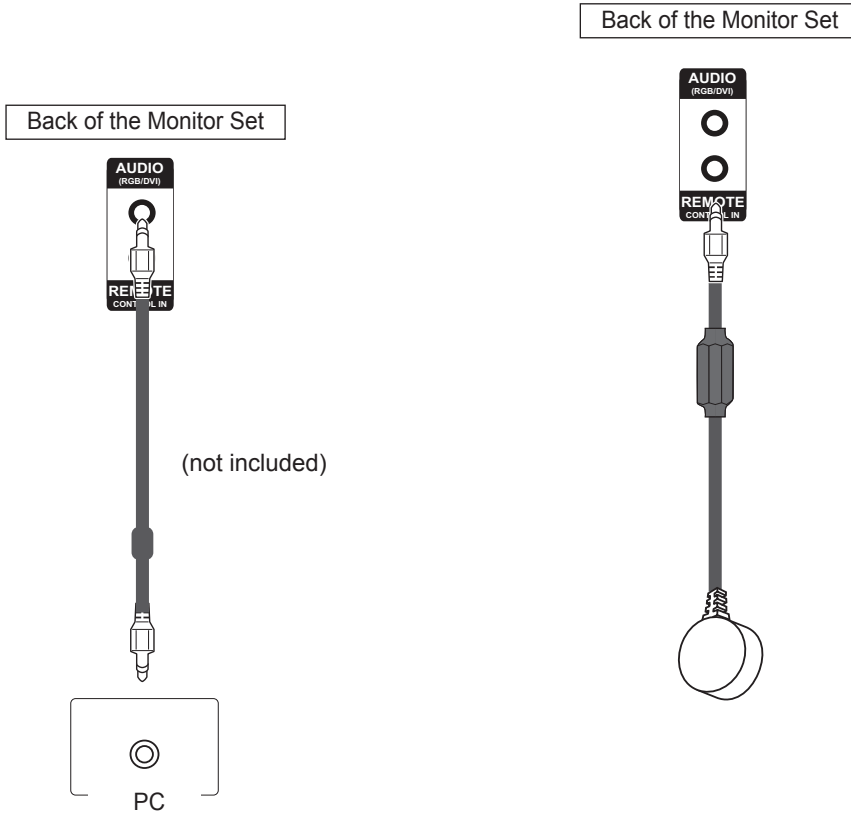

NOTE

- To ensure the best sound quality and minimize noise, keep the cable as short as possible.

Adjusting the screen

Selecting an image mode

Display images using optimized settings by selecting one of the preset image modes.

- 1 Press **MENU** to access the main menus.
- 2 Press the Navigation buttons to scroll to **PICTURE** and press **OK**.
- 3 Press the Navigation buttons to scroll to **Picture Mode** and press **OK**.
- 4 Press the Navigation buttons to scroll to an image mode you want and press **OK**.

Mode	Description
Vivid	Adjusts the video image for the retail environment by enhancing the Contrast, Brightness, Color, and Sharpness .
Standard	Adjusts the image for the normal environment.
Cinema	Optimizes the video image for the cinematic look and enjoy movies as if you are in a movie theater.
Sports	Optimizes the video image for high and dynamic actions by emphasizing primary Colors such as white, grass, or sky blue.
Game	Optimizes the video image for a fast gaming screen such as PCs or games.

- 5 When you are finished, press **EXIT**.
When you return to the previous menu, press **BACK**.

Customizing image options

Customize basic and advanced options of each image mode for the best screen performance.

- 1 Press **MENU** to access the main menus.
- 2 Press the Navigation buttons to scroll to **PICTURE** and press **OK**.
- 3 Press the Navigation buttons to scroll to **Picture Mode** and press **OK**.
- 4 Press the Navigation buttons to scroll to an image mode you want and press **OK**.
- 5 Select and adjust following options, and then press **OK**.

Option	Description
Backlight	Adjusts the brightness of the screen by controlling the LCD backlight. If you decrease the brightness level, the screen becomes darker and the power consumption will be reduced without any video signal loss.
Contrast	Increases or decreases the gradient of the video signal. You may use Contrast when the bright part of the image is saturated.
Brightness	Adjusts the base level of the signal in the image. You may use Brightness when the dark part of the image is saturated.
Sharpness	Adjusts the level of crispness in the edges between the light and dark areas of the picture. The lower the level, the softer the image.
Color	Adjusts the balance between Red and Green levels.
Tint	Adjusts intensity of all Colors .
Color Temperature	Set to warm to enhance hotter Colors such as red, or set to cool to make picture bluish.

Advanced Control	Customizes the advanced options. See more information about advanced options See p.46.
Picture Reset	Restores the options to the default setting.

- When you are finished, press **EXIT**.
When you return to the previous menu, press **BACK**.

Customizing PC display options

Customize options of each image mode for the best image quality.

- This function works in the following mode: RGB[PC] mode.
- Press **MENU** to access the main menus.
 - Press the Navigation buttons to scroll to **PICTURE** and press **OK**.
 - Press the Navigation buttons to scroll to **Screen** and press **OK**.
 - Select and adjust following options, and then press **OK**.

Option	Description
Resolution	Selects a proper Resolution .
Auto Configure	Sets to adjust the screen Position , Size and Phase automatically. The displayed image may be unstable for a few seconds while the configuration is in progress.
Position/ Size/Phase	Adjusts the options when the image is not clear, especially when characters are shaky, after the auto configuration.
Reset	Restores the options to the default setting.

- When you are finished, press **EXIT**.
When you return to the previous menu, press **BACK**.

Adjusting the sound

Selecting an sound mode

Play the sound in its optimized settings by selecting one of the preset sound modes.

- Press **MENU** to access the main menus.
- Press the Navigation buttons to scroll to **AUDIO** and press **OK**.
- Press the Navigation buttons to scroll to **Sound Mode** and press **OK**.
- Press the Navigation buttons to scroll to a sound mode you want and press **OK**.

Mode	Description
Standard	Selects when you want standard-quality sound.
Music	Selects when you listen to music.
Cinema	Selects when you watch movies.
Sports	Selects when you watch sports events.
Game	Selects when you play games.

- When you are finished, press **EXIT**.
When you return to the previous menu, press **BACK**.

Customizing sound options

Customize options of each sound mode for the best sound quality.

- 1 Press **MENU** to access the main menus.
- 2 Press the Navigation buttons to scroll to **AUDIO** and press **OK**.
- 3 Press the Navigation buttons to scroll to **Sound Mode** and press **OK**.
- 4 Press the Navigation buttons to scroll to a sound mode you want and press **OK**.
- 5 Select and adjust following options, and then press **OK**.

Option	Description
Infinite Sound	LG's Infinity Sound option provides 5.1 channel stereo sound from two speakers.
Treble	Controls the dominant sounds in the output. When you turn up the treble, it will increase the output to the higher frequency range.
Bass	Controls the softer sounds in the output. When you turn up the bass, it will increase the output to the lower frequency range.
Reset	Resets the sound mode to the default setting.

- 6 When you are finished, press **EXIT**.
When you return to the previous menu, press **BACK**.

Using additional options

Adjusting aspect ratio

Resize the image to view the image at its optimal size by pressing **ARC** while you are watching Monitor set.



CAUTION

- If a fixed image displays on the screen for a long period of time, it will be imprinted and become a permanent disfigurement on the screen. This is "image burn" or "burn-in" and not covered by the warranty.
- If the aspect ratio is set to 4:3 for a long period of time, image burn may occur on the letterboxed area of the screen.



NOTE

You can also change the image size by accessing the main menus.

MODE \ ARC	AV	Component	RGB		DVI-D		HDMI	
			PC	DTV	PC	DTV	PC	
16:9	o	o	o	o	o	o	o	o
Just Scan	x	o	x	o	x	o	x	x
1:1	x	x	o	x	o	x	o	o
4:3	o	o	o	o	o	o	o	o
Zoom	o	o	x	o	x	o	x	x
Cinema Zoom	o	o	x	o	x	o	x	x

- **16:9** : This selection will allow you to adjust the picture horizontally, in linear proportion, to fill the entire screen(useful for viewing 4:3 formatted DVDs).

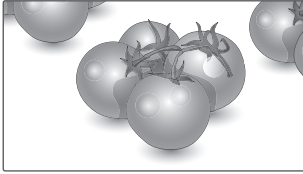

- **4:3** : This selection will allow you to view a picture with an original 4:3 aspect ratio, black bars will appear on both the left and right of the screen.

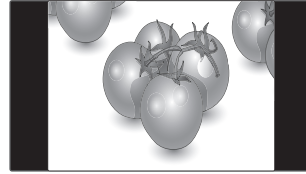

- **Just Scan** : This Selection will allow you view the picture of best quality without loss of original picture in high resolution image. Note: If there is noise in original Picture, You can see the noise at the edge.



- **Zoom** : This selection will allow you to view the picture without any alteration, while filling the entire screen. However, the top and bottom of the picture will be cropped.

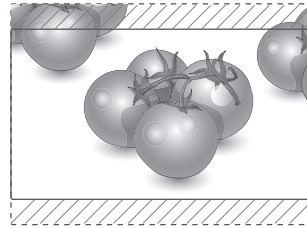

- **1:1** : The aspect ratio is not adjusted from the original. (Only HDMI PC, DVI-D PC, RGB PC)
* Pictures with resolution higher than 1366X768 are adjusted to the 1366x768 while maintaining the original aspect ratio.

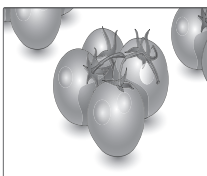

- **Cinema Zoom** : Choose Cinema Zoom when you want to enlarge the picture in correct proportion. Note: When enlarging or reducing the picture, the image may become distorted.

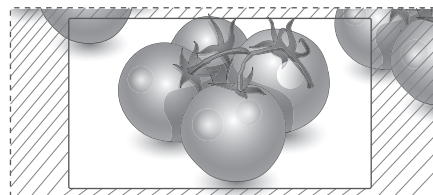

ENTERTAINMENT

Connecting to a wired network

(Depending on model)

Connect the display to a local area network (LAN) via the LAN port as shown on the following illustration and set up the network settings.

Only supports wired network connection.

After making a physical connection, a small number of networks may require the display network settings to be adjusted. For most networks, the display will connect to automatically without any adjustments.

For detailed information, contact your internet provider or router manual.

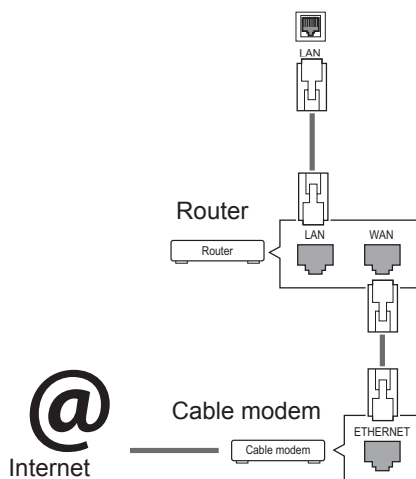

CAUTION

- Do not connect a modular phone cable to the LAN port.
- Since there are various connection methods, please follow the specifications of your telecommunication carrier or internet service provider.

To set up the network settings: (Even if your display has already connected automatically, running setup again will not harm anything),

- 1 Press **MENU** to access the main menus.
- 2 Press the Navigation buttons to scroll to **NETWORK** and press **OK**.
- 3 Press the Navigation buttons to select **Network Setting** and press **OK**.
- 4 If you already set Network Setting, select **Resetting**. The new connection settings resets the current network settings.
- 5 Select **IP Auto Setting** or **IP Manual Setting**.
 - If selecting **IP Manual Setting**, press the Navigation and Number buttons. IP addresses will need to be input manually.
 - **IP Auto Setting**: Select this if there is a DHCP server (Router) on the local area network (LAN) via wired connection, the display will automatically be allocated an IP address. If you're using a broadband router or broadband modem that has a DHCP (Dynamic Host Configuration Protocol) server function. The IP address will automatically be determined.
- 6 When you are finished, press **EXIT**.



CAUTION

- Network setting menu will not be available until the display connected to physical network.
- Since there are various connection methods, please follow the specifications of your telecommunication carrier or internet service provider.

! NOTE

- If you want to access the Internet directly on your display, the internet connection should always be on.
- If you cannot access the Internet, check the network conditions from a PC on your network.
- When you use **Network Setting**, check the LAN cable or check if DHCP in the router is turned on.
- If you do not complete the network settings, the network may not work properly.

Tips for Network setting

- Use a standard LAN cable with this display. Cat5 or better with a RJ45 connector.
- Many network connection problems during set up can often be fixed by re-setting the router or modem. After connecting the display to the network, quickly power off and/or disconnect the power cable of the network router or cable modem. Then power on and/or connect the power cable again.
- Depending on the internet service provider (ISP), the number of devices that can receive internet service may be limited by the applicable terms of service. For details, contact your ISP.
- LG is not responsible for any malfunction of the display and/or the internet connection feature due to communication errors/malfunctions associated with your internet connection, or other connected equipment.
- LG is not responsible for problems within your internet connection.
- You may experience undesired results if the network connection speed does not meet the requirements of the content being accessed.
- Some internet connection operations may not be possible due to certain restrictions set by the Internet service provider (ISP) supplying your Internet connection.
- Any fees charged by an ISP including, without limitation, connection charges are your responsibility.
- A 10 Base-T or 100 Base-TX LAN port is required when using a wired connection to this display. If your internet service does not allow for such a connection, you will not be able to connect the display.

- A DSL modem is required to use DSL service and a cable modem is required to use cable modem service. Depending on the access method of and subscriber agreement with your ISP, you may not be able to use the internet connection feature contained in this display or you may be limited to the number of devices you can connect at the same time. (If your ISP limits sub-scription to one device, this display may not be allowed to connect when a PC is already connected.)
- The use of a "Router" may not be allowed or its usage may be limited depending on the policies and restrictions of your ISP. For details, contact your ISP directly.

Network Status

- 1 Press **MENU** to access the main menus.
- 2 Press the Navigation buttons to scroll to **NETWORK** and press **OK**.
- 3 Press the Navigation buttons to select **Network Status**.
- 4 Press **OK** to check the network status.
- 5 When you are finished, press **EXIT**.

Option	Description
Setting	Return to the network setting menu.
Test	Test the current network status after setting the network.
Close	Return to the previous menu.

Connecting USB storage devices

Connect USB storage devices such as a USB flash memory, external hard drive to the display and use multimedia features (See "Browsing files" on page 31).

Connect a USB flash memory or USB memory card reader to the Display as shown on the following illustration. The My media screen appears.

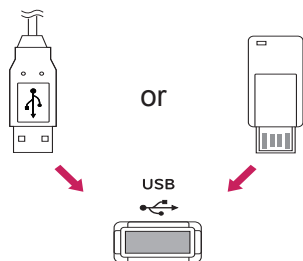

CAUTION

- Do not turn the display off or remove a USB storage device while my media-Menu is activated, as this could result in loss of files or damage to the USB storage device.
- Back up your files saved on a USB storage device frequently, as you may lose or damage the files and this may be not covered by the warranty.

Tips for using USB storage devices

- Only a USB storage device is recognizable.
- If the USB storage device is connected through a USB hub, the device is not recognizable.
- A USB storage device using an automatic recognition program may not be recognized.
- A USB storage device which uses its own driver may not be recognized.
- The recognition speed of a USB storage device may depend on each device.
- Please do not turn off the display or unplug the USB device when the connected USB storage device is working. When such device is suddenly separated or unplugged, the stored files or the USB storage device may be damaged.
- Please use only a USB storage device which was formatted as a FAT32 file system or NTFS file system provided with the Windows operating system. In case of a storage device formatted as a different utility program which is not supported by Windows, it may not be recognized.
- Please connect power to a USB storage device(over 0.5 A) which requires an external power supply. If not, the device may not be recognized.
- Please connect a USB storage device with the cable provided by the device maker.
- Some USB storage devices may not be supported or operated smoothly.
- File alignment method of USB storage device is similar to Window XP and filename support of up to 100 English characters.
- Be sure to back up important files since data stored in a USB memory device may be damaged. We will not be responsible for any data loss.

- If the USB HDD does not have an external power source, the USB device may not be detected. So be sure to connect the external power source.
 - Please use a power adaptor for an external power source. We do not guarantee an USB cable for an external power source.
- If your USB memory device has multiple partitions, or if you use a USB multi-card reader, you can use up to 4 partitions or USB memory devices.
- If a USB memory device is connected to a USB multi-card reader, its volume data may not be detected.
- If the USB memory device does not work properly, disconnect and reconnect it.
- How fast a USB memory device is detected differs from device to device.
- If the USB is connected in Standby Mode, specific hard disk will automatically be loaded when the display is turned on.
- The recommended capacity is 1 TB or less for a USB external hard disk and 32 GB or less for USB memory.
- Any device with more than the recommended capacity may not work properly.
- If a USB external hard disk with a “Energy Saving” function does not work, turn the hard disk off and on again to make it work properly.
- USB storage devices below USB 2.0 are supported as well. But they may not work properly in the movie list.
- Maximum of 999 folders or files can be recognized under one folder.

Browsing files

Access the photo, music, or movie lists and browse files.

- 1 Connect a USB storage device.
- 2 Press **MENU** to access the main menus.
- 3 Press the Navigation buttons to scroll to **My Media** and press **OK**.
- 4 Press Navigation buttons to scroll to **MUSIC LIST**, **PHOTO LIST** or **MOVIE LIST** and press **OK**.

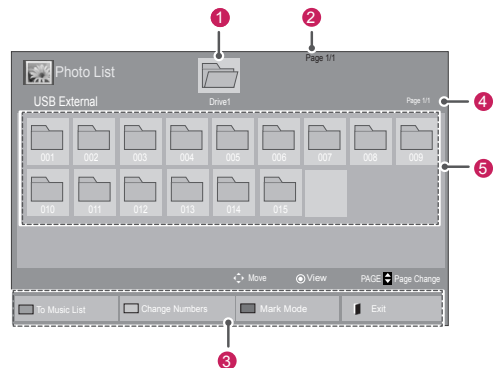
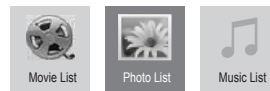

No.	Description
①	Moves to upper level folder
②	Current page/Total pages
③	Corresponding buttons on the remote control
④	Current page/ total pages of contents under the folder focused on ①
⑤	Contents under the folder focused on ①
Button	Description
Green button	Repeatedly, press the GREEN button to converted to Photo List->Music List , Music List->Movie List or Movie List->Photo List .
Yellow button	A method to view in 5 large thumbnail or simple list.
Blue button	Convert to Mark Mode.

Supported file format

Type	Supported file format																		
Movie	DAT,MPG,MPEG,VOB,AVI,DivX,MP4,MKV,TS,TRP,TP,ASF,WMV,FLV) Movie (* .mpg/* .mpeg/* .dat/* .ts/* .trp/* .tp/* .vob/* .mp4/* .mov/* .mkv/* .divx/* .avi/* .asf/* .wmv/* .flv/* .avi(motion-jpeg)/* .mp4(motion-jpeg)/* .mkv(motion-jpeg))supporting file Video format : DivX3.11, DivX4.12, DivX5.x, DivX6, Xvid1.00, Xvid1.01, Xvid1.02, Xvid1.03, Xvid1.10 beta-1/beta-2, Mpeg-1, Mpeg-2, Mpeg-4, H.264/AVC, VC1, JPEG, Sorenson H.263 Audio format : Dolby Digital, AAC, Mpeg, MP3, LPCM, HE-AAC, ADPCM, WMA Bit rate : within 32 kbps to 320 kbps(MP3) External Subtitle format : *.smi/* .srt/* .sub (MicroDVD,Subviewer1.0/2.0)/* .ass/* .ssa/* .txt(TMPlayer)/* .psb(PowerDivX) Internal Subtitle format : only, XSUB (It is the subtitle format used in DivX6 files)																		
	Photo	JPEG Baseline : 64 x 64 to 15360 x 8640 Progressive : 64 x 64 to 1920 x 1440 <ul style="list-style-type: none"> You can play JPEG files only. Non-supported files are displayed in the form of predefined icon. Only 3D Models <table border="1"> <thead> <tr> <th></th> <th>File Extensions</th> <th>Item</th> <th>Profile</th> </tr> </thead> <tbody> <tr> <td rowspan="2">2D</td> <td rowspan="2">jpeg jpg jpe</td> <td>supported file format</td> <td> <ul style="list-style-type: none"> SOF0: baseline SOF1: Extend Sequential SOF2: Progressive </td> </tr> <tr> <td>photo size</td> <td> <ul style="list-style-type: none"> Min: 64 X 64 Max-Normal Type: 15360 (W) X 8640 (H) Progressive Type: 1920 (W) X 1440 (H) </td> </tr> <tr> <td rowspan="2">3D</td> <td rowspan="2">mpo</td> <td>supported file format</td> <td>mpo</td> </tr> <tr> <td>photo size</td> <td> <ul style="list-style-type: none"> 4:3 size: 3,648 x 2,736 2,592 x 1,944 2,048 x 1,536 3:2 size: 3,648 x 2,432 </td> </tr> </tbody> </table>				File Extensions	Item	Profile	2D	jpeg jpg jpe	supported file format	<ul style="list-style-type: none"> SOF0: baseline SOF1: Extend Sequential SOF2: Progressive 	photo size	<ul style="list-style-type: none"> Min: 64 X 64 Max-Normal Type: 15360 (W) X 8640 (H) Progressive Type: 1920 (W) X 1440 (H) 	3D	mpo	supported file format	mpo	photo size
	File Extensions	Item	Profile																
2D	jpeg jpg jpe	supported file format	<ul style="list-style-type: none"> SOF0: baseline SOF1: Extend Sequential SOF2: Progressive 																
		photo size	<ul style="list-style-type: none"> Min: 64 X 64 Max-Normal Type: 15360 (W) X 8640 (H) Progressive Type: 1920 (W) X 1440 (H) 																
3D	mpo	supported file format	mpo																
		photo size	<ul style="list-style-type: none"> 4:3 size: 3,648 x 2,736 2,592 x 1,944 2,048 x 1,536 3:2 size: 3,648 x 2,432 																

Music	MP3 Bit rate 32 to 320 <ul style="list-style-type: none"> Sampling rate MPEG1 Layer3 : 32 kHz, 44.1 kHz, 48 kHz Sampling rate MPEG2 Layer3 : 16 kHz, 22.05 kHz, 24 kHz Sampling rate MPEG2.5 Layer3 : 8 kHz, 11.025 kHz, 12 kHz
--------------	--

Viewing movies

This display will play media files from a USB drive or a DLNA server on your network.

- 1 Press the Navigation buttons to scroll to **My Media** and press **OK**.
- 2 Press the Navigation buttons to scroll to **Movie List** and press **OK**.
- 3 Press the Navigation buttons to scroll to a folder you want and press **OK**.
- 4 Press the Navigation buttons to scroll to a file you want and press **OK**.

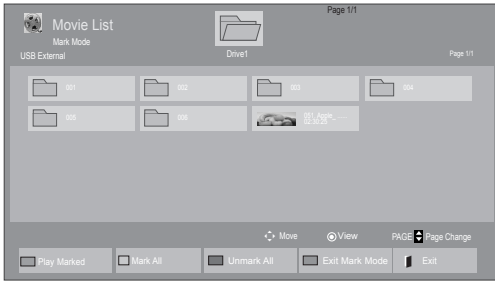
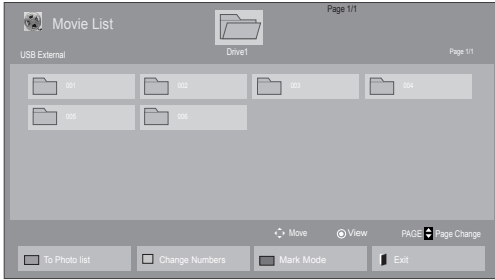

6 Control playback by using the following buttons.



Button	Description
	Stops the playback
	Plays a video
	Pauses or resumes the playback
	Scans backward in a file
	Scans forward in a file
	Show the Option menu.
	Hide the menu on the full-sized screen.
	Return to Movie List .
"<" or ">"	Skips to specific points in a file during playback. The time of a specific point will appear on the status bar. In some files, this function may not work properly.
 ENERGY SAVING	Press the ENERGY SAVING button repeatedly to increase the brightness of your screen.

5 Play a movie.

NOTE

- Non-supported files are displayed the preview image by icon only .
- Abnormal files are displayed in the form of bitmap .

Tips for using playing video files

- Some user-created subtitles may not work properly.
- Some special characters are not supported in subtitles.
- HTML tags are not supported in subtitles.
- Subtitles in languages other than the supported languages are not available.
- The screen may suffer temporary interruptions (image stoppage, faster playback, etc.) when the audio language is changed.
- A damaged movie file may not be played correctly, or some player functions may not be usable.
- Movie files produced with some encoders may not be played correctly.
- If the video and audio structure of recorded file is not interleaved, either video or audio is outputted.
- Videos with resolution higher than 1920X1080 at 25/30P may not play properly depending on the frame.
- Movie files other than the specified types and formats may not work properly.
- Max bitrate of playable movie file is 20 Mbps. (only, Motion JPEG : 10 Mbps)
- We do not guarantee smooth playback of profiles encoded level 4.1 or higher in H.264/AVC.
- DTS Audio codec is not supported.
- A movie file more than 30 GB in file size is not supported for playback.
- A DivX movie file and its subtitle file must be located in the same folder.
- A video file name and its subtitle file name must be identical for it to be displayed.
- Playing a video via a USB connection that doesn't support high speed may not work properly.
- Files encoded with GMC(Global Motion Compensation) may not be played.
- When you are watching the movie by Movie List function, you can adjust an image by Energy Saving key on the remote control. User setup for each image mode does not operate.

Video options

- 1 Press **MENU** to access the **Pop-Up** menus.
- 2 Press the Navigation buttons to scroll to **Set Video Play.**, **Set Video.** or **Set Audio.** and press **OK**.

**NOTE**

- Option values changed in **Movie List** does not affect **Photo List** and **Music List**.
- Option value changed in **Photo List** and **Music List** are changed likewise in **Photo List** and **Music List** excluding **Movie List**.
- When replaying the video file after stopping, you can play from where it stopped previously.

When you select the **Set Video Play**,

- 1 Press the Navigation buttons to scroll to show the **Picture Size, Audio Language, Subtitle Language** or **Repeat**.
- 2 Press the Navigation buttons to scroll to make appropriate adjustments.

Menu	Description
Picture Size	Selects your desired picture format during movie play.
Audio Language	Changes the Language Group of the audio during movie play. Files with a single audio track cannot be selected.
Subtitle Language	Turn on/off the subtitle.
Language	Activated for SMI subtitle and can select the language within the subtitle.
Code Page	Can select the font for subtitle. When set to default, same font as general menu will be used.
Sync	Adjusts the time synchronisation of the subtitle from -10 secs to +10 secs by steps of 0.5 secs during movie play.
Position	Changes the position of the subtitle either up or down during movie play.
Size	Selects your desired Subtitle size during movie play.
Repeat	Turn on/off repeat function of movie playback. When turned on, the file within the folder will be played back repeatedly. Even when the repeated playback is turned off, it can run the playback if the file name is similar to the previous file.

Code Page	Support Language
Latin1	English, Spanish, French, German, Italian, Swedish, Finnish, Dutch, Portuguese, Danish, Romanian, Norwegian, Albanian, Gaelic, Welsh, Irish, Catalan, Valencian
Latin2	Bosnian, Polish, Croatian, Czech, Slovak, Slovenian, Serbian, Hungarian
Latin4	Estonian, Latvian, Lithuanian
Cyrillic	Bulgarian, Macedonian, Russian, Ukrainian, Kazakh
Greek	Greek
Turkish	Turkish



NOTE

- Only 10,000 of sync blocks can be supported within the subtitle file.
- When playing a video, you can adjust the Picture Size by pressing the **RATIO** button.
- Subtitles in your language are only supported when the OSD menu is also in this language.
- The code page options may be disabled depending on the language of the subtitle files.
- Select the appropriate code page for the subtitle files.

When you select the **Set Video**,

- 1 Press the Navigation buttons to scroll to make appropriate adjustments.

When you select the **Set Audio**,

- 1 Press the Navigation buttons to scroll to show the **Sound Mode**, **Clear Voice II** or **Balance**.
- 2 Press the Navigation buttons to scroll to make appropriate adjustments.

Viewing photos

View image files saved in a USB storage device. The displays on the screen may differ from the model.

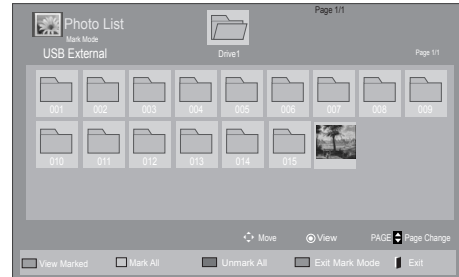
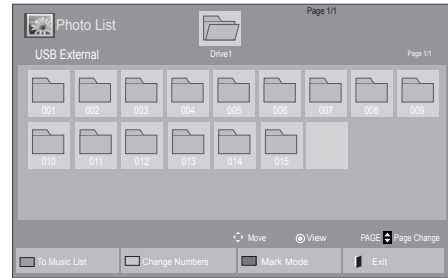

- 1 Press the Navigation buttons to scroll to **My Media** and press **OK**.
- 2 Press the Navigation buttons to scroll to **Photo List** and press **OK**.
- 3 Press the Navigation buttons to scroll to a folder you want and press **OK**.
- 4 Press the Navigation buttons to scroll to a file you want and press **OK**.



Menu	Description
View Marked	Display the selected photo file.
Mark All	Mark all photo files on the screen.
Unmark All	Deselect all marked photo files.
Exit Mark Mode	Exit the Mark Mode.

- 5 View photos.

NOTE

- Non-supported files are displayed the pre-view image by icon only .
- Abnormal files are displayed in the form of bitmap .

Using photo options

Use the following options while viewing photos.



Options

Number of selected photos

Option	Description
Slideshow	Starts or stops a slideshow with selected photos. If there are no selected photos, all photos saved in the current folder display during a slideshow. Select Option to set the speed and view mode of the slideshow.
BGM	Turns the background music on or off. To set the background music folder, select Option . You can adjust Option by MENU button on the remote control.
Rotate	Rotates photos clockwise (90°, 180°, 270°, 360°). <div style="border: 1px solid black; padding: 5px;"> <p>NOTE</p> <ul style="list-style-type: none"> The supported photo size is limited. You cannot rotate a photo if the resolution of the rotated width is larger than the supported resolution size. </div>
Zoom	Enlarges the image to 200% or 400%. <div style="border: 1px solid black; padding: 5px;"> <p>NOTE</p> <ul style="list-style-type: none"> Zoom to 200% or 400% only work for image of 1372×772 pixel size or larger. For image of 960×540 pixel size or larger, only zoom to 400% works properly. </div>

ENERGY SAVING	Press the ENERGY SAVING button repeatedly to change the brightness of your screen.
MENU Option	<ul style="list-style-type: none"> Slide Speed: Selects a slideshow speed (Fast, Medium, Slow). TransitionEffect: Set the view mode of the slideshow. BGM: Selects a music folder for the background music. <div style="border: 1px solid black; padding: 5px; margin-top: 10px;"> <p>NOTE</p> <ul style="list-style-type: none"> You cannot change the music folder while the background music is playing. You can only select the MP3 folder saved on the device that currently displays the photo. </div>
Hide	Hides the option window. To display the options, press OK .
EXIT	Return to Photo List .

Photo options

- 1 Press **MENU** to show the **Option** menus.
- 2 Press the Navigation buttons to scroll to **Set Photo View.**, **Set Video.** or **Set Audio.** and press **OK**.





NOTE

- Option values changed in **Movie List** does not affect **Photo List** and **Music List**.
- Option value changed in **Photo List** and **Music List** are changed likewise in **Photo List** and **Music List** excluding **Movie List**.

When you select the **Set Photo View**,

- 1 Press the Navigation buttons to scroll to select **Slide Speed**, **Transition Effect** or **BGM**.
- 2 Press the Navigation buttons to scroll to make appropriate adjustments.

Transition Effect Option

Option	Description
Sliding	Pushes the current slide out of view as it plays to the next slide. 
Stairs	Pushes the current slide in a staircase shape as it plays to the next slide. 
Door Open /Close	Pushes the current slide like opening or closing the door as it plays to the next slide. 
Shutter	Pushes the current slide like drawing or pulling down the blind as it plays to the next slide 
Fade In	Fades the slide out slowly before playing to the next slide. 

When you select the **Set Video**,

- 1 Press the Navigation buttons to scroll to make appropriate adjustments.

When you select the **Set Audio**,

- 1 Press the Navigation buttons to scroll to show the **Sound Mode**, **Clear Voice II** or **Balance**.
- 2 Press the Navigation buttons to scroll to make appropriate adjustments.

Listening to music

- 1 Press the Navigation buttons to scroll to **My Media** and press **OK**.
- 2 Press the Navigation buttons to scroll to **Music List** and press **OK**.
- 3 Press the Navigation buttons to scroll to a folder you want and press **OK**.
- 4 Press the Navigation buttons to scroll to a file you want and press **OK**.

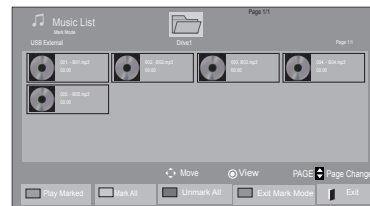
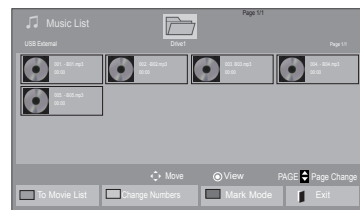

Menu	Description
Play Marked	Display the selected music file.
Mark All	Mark all music files on the screen.
Unmark All	Deselect all marked music files.
Exit Mark Mode	Exit the Mark Mode.

- 5 Play music.

6 Control playback by using the following buttons.

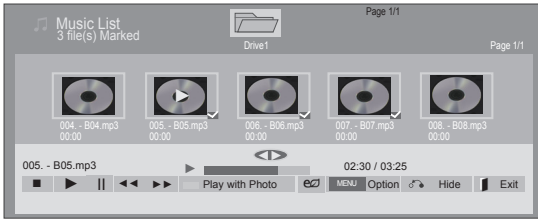

Button	Description
	Stops playback
	Plays a music file
	Pauses or resumes playback
	Skips to the next file
	Skips to the previous file
	When playing, When you press the button, the previous music file will be played. When you press the button, the next music file will be played.
Green button	Start playing the selected music files and then move to the Photo List .
ENERGY SAVING	Press the ENERGY SAVING button repeatedly to change the brightness of your screen.
Option	Show the Option menu.
Hide	Hides the option window. To display the options, press OK .
EXIT	When you press the EXIT button while the Music player is displayed, only the music will be stopped and the player will not return to normal viewing. When you press the EXIT button while the music is stopped or while the music player is hidden, the player will return to normal viewing.
"<" or ">"	When using the < or > button during playback a cursor indicating the position can be played.

Tips for playing music files

- This unit cannot support the ID3 Tag embedded MP3 files.

NOTE

- Non-supported files are displayed the preview image by icon only
- Abnormal files are displayed in the form of bitmap
- A damaged or corrupted music does not play but displays 00:00 in playtime.
- A music downloaded from a paid service with copyright protection does not start but displays inappropriate information in playtime.
- If you press **OK**, buttons, screen saver is stopped.
- The **PLAY**() , **Pause**() , , , buttons on the remote control are also available in this mode.
- You can use the button to select the next music and the button to select the previous music.

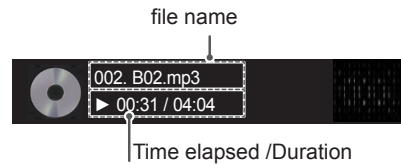

Music options

- 1 Press **MENU** to access the **Pop-Up** menus.
- 2 Press the Navigation buttons to scroll to **Set Audio Play.** or **Set Audio.** and press **OK**.

NOTE

- Option values changed in **Movie List** does not affect **Photo List** and **Music List**.
- Option value changed in **Photo List** and **Music List** are changed likewise in **Photo List** and **Music List** excluding **Movie List**.

When you select the **Set Audio Play.**,

- 1 Press the Navigation buttons to scroll to select the **Repeat** or **Random**.
- 2 Press the Navigation buttons to scroll to make appropriate adjustments.

When you select the **Set Audio.**,

- 1 Press the Navigation buttons to scroll to select the **Sound Mode**, **Clear Voice II** or **Balance**.
- 2 Press the Navigation buttons to scroll to make appropriate adjustments.

DivX® VOD Guide**DivX® VOD Registration**

In order to play purchased or rented DivX® VOD contents, you should register your device with 10 digit DivX registration code from your device at www.divx.com/vod.

- 1 Press **MENU** to access the main menus.
- 2 Press the Navigation buttons to scroll to **MY MEDIA** and press **OK**.
- 3 Press the Blue button.
- 4 Press the Navigation buttons to scroll to **DivX Reg. Code** and press **OK**.
- 5 View the registration code of your display.
- 6 When you are finished, press **EXIT**.
When you return to the previous menu, press **BACK**.

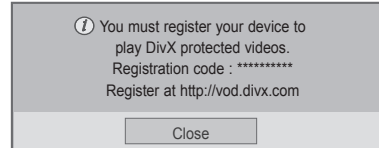
**NOTE**

- While you are checking the registration code, some buttons may not work.
- If you use the DivX registration code of another device, you cannot play the rented or purchased DivX file. Make sure to use the DivX registration code assigned to your TV.
- The video or audio files that are not converted by the standard DivX codec may be corrupted or not be played.
- The DivX VOD code allows you to activate up to 6 devices under one account.

DivX® VOD Deregistration

You should deregister your device with 8 digit DivX deregistration code from your device at www.divx.com/vod.

- 1 Press **MENU** to access the main menus.
- 2 Press the Navigation buttons to scroll to **MY MEDIA** and press **OK**.
- 3 Press the Blue button.
- 4 Press the Navigation buttons to scroll to **Deactivation** and press **OK**.
- 5 Press the Navigation buttons to select **Yes** to confirm.

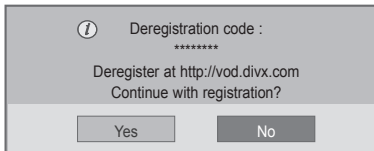

- 6 When you are finished, press **EXIT**.
When you return to the previous menu, press **BACK**.

NOTE

- Once the deregistration is executed, you must register your device again to see DivX® VOD contents.

CUSTOMIZING SETTINGS

Accessing main menus

- 1 Press **MENU** to access the main menus.
- 2 Press the Navigation buttons to scroll to one of the following menus and press **OK**.
- 3 Press the Navigation buttons to scroll to the setting or option you want and press **OK**.
- 4 When you are finished, press **EXIT**.
When you return to the previous menu, press **BACK**.

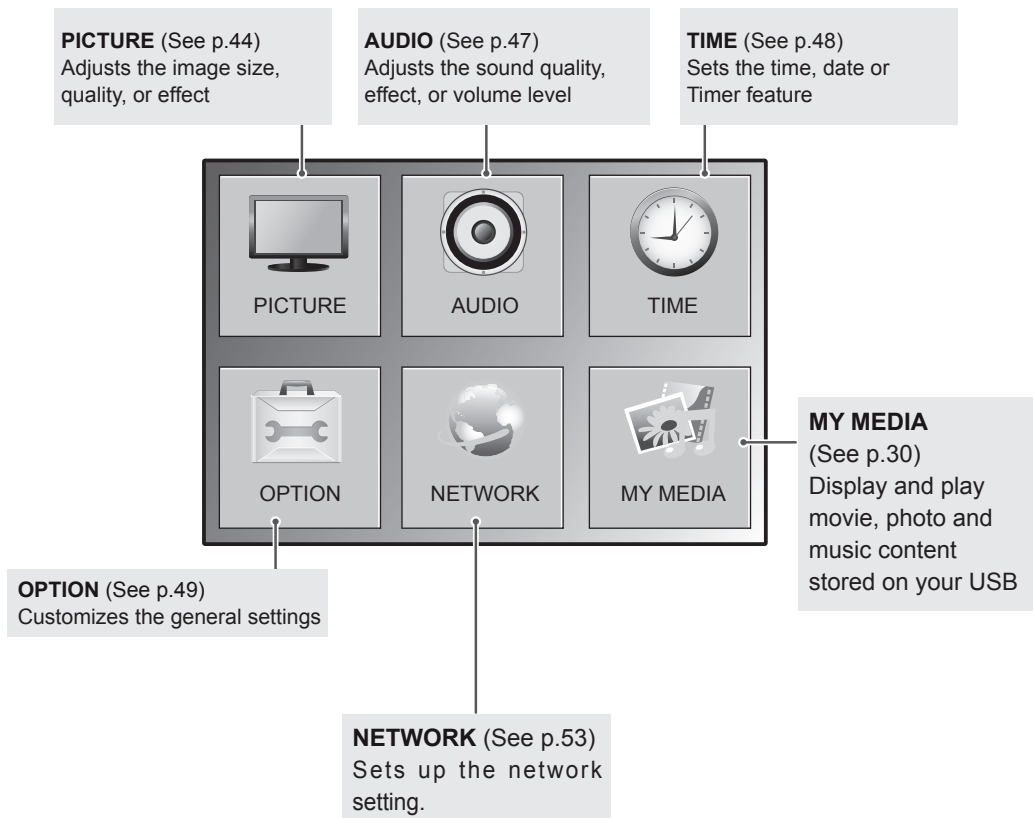

PICTURE settings

- 1 Press **MENU** to access the main menus.
- 2 Press the Navigation buttons to scroll to **PICTURE** and press **OK**.
- 3 Press the Navigation buttons to scroll to the setting or option you want and press **OK**.
 - To return to the previous level, press **BACK**.
- 4 When you are finished, press **EXIT**.
When you return to the previous menu, press **BACK**.

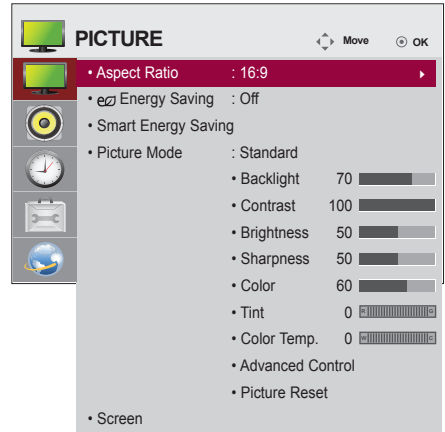

The available picture settings are described in the following:

Setting	Description	
Aspect Ratio	Changes the image size to view images at its optimal size (See p.26).	
Energy Saving	Sets to automatically adjust the screen brightness corresponding to the surroundings.	
	Option	
	Off	The backlight is off.
	Minimum/ Medium/ Maximum	Selects the brightness level of the backlight.
Smart Energy Saving	Screen off	The screen turns off in 3 seconds.
	Adjusts the backlight and contrast depending on the screen brightness. * 47WV30-BAAL does not support this function.	
	Level	
	On	Enables the Smart Energy Saving function to save power consumption as much as the value set in the smart energy saving rate.
	Off	Disables the Smart Energy Saving function.
Picture Mode	Selects one of the preset image or customizes options in each mode for the best Monitor set screen performance. You are also able to customize advanced options of each mode. The available preset picture modes vary depending on the Monitor set .	
	Mode	
	Vivid	Adjusts the video image for the retail environment by enhancing the contrast, brightness, Color, and sharpness.
	Standard	Adjusts the image for the normal environment.
	Cinema	Optimizes the video image for a cinematic look to enjoy movies as if you are in a movie theater.
	Sport	Optimizes the video image for high and dynamic actions by emphasizing primary Colors such as white, grass, or sky blue.
Game	Optimizes the video image for a fast gaming screen such as PCs or games.	

Setting	Description	
SCREEN (In RGB-PC Mode Only)	Customizes the PC display options in RGB mode.	
	Option	
	Resolution	Selects a proper resolution.
	Auto Configure	Sets to adjust the screen position, clock, and phase automatically. The displayed image may be unstable for a few seconds while the configuration is in progress.
	Position/Size/Phase	Adjusts the options when the picture is not clear, especially when characters are shaky, after the auto configuration.
Reset	Restores the options to the default setting.	

Basic image options

Setting	Description
Backlight	Adjusts the brightness of the screen by controlling the LCD backlight. If you decrease the brightness level, the screen becomes darker and the power consumption will be reduced without any video signal loss.
Contrast	Increases or decreases the gradient of the video signal. You may use Contrast when the bright part of the picture is saturated.
Brightness	Adjusts the base level of the signal in the picture. You may use Brightness when the dark part of the picture is saturated.
Sharpness	Adjusts the level of crispness in the edges between the light and dark areas of the picture. The lower the level, the softer the image.
Color	Adjusts the balance between red and green levels.
Tint	Adjusts intensity of all Colors.
Color Temperature	Set to warm to enhance hotter Colors such as red, or set to cool to make picture bluish.
Advanced Control	Customizes the advanced options.
Picture Reset	Restores the options to the default setting.

! NOTE

- If the 'Picture Mode' setting in the Picture menu is set to **Vivid, Standard, Cinema, Sport** or **Game** the subsequent menus will be automatically set.
- You cannot adjust color and tint in the RGB-PC / HDMI-PC mode.
- When using the Smart Energy Saving function, the screen may look saturated in the white area of a still image.
- If Energy Saving is set to Minimum, Medium, or Maximum, the Smart Energy Saving function is disabled.

Advanced image options

Setting	Description
Dynamic Contrast (Off/Low/Medium/High)	Optimizes the contrast automatically according to the brightness of the reflection. (This function can be used only under Component.)
Dynamic Color (Off/Low/High)	Adjusts the Color of the reflection automatically to reproduce natural colours as close as possible.(This function can be used only under Component.)
Clear White (Off/Low/High)	Make the white area of screen brighter and more white.
Skin Color	It detects the skin area of video and adjusts it to express a natural skin color.
Noise Reduction (Off/Low/Medium/High)	Removing the noise up to the point where it does not damage the original picture. (This function can be used only under Component.)
Digital Noise Reduction (Off/Low/Medium/High)	This option reduces the noise produced while creating digital video signals.
Gamma (Low/Medium/High)	Set your own gamma value. On the monitor, high gamma values display whitish images and low gamma values display high contrast images.
Black Level Low/High	<ul style="list-style-type: none"> • Low: The reflection of the screen gets darker. • High: The reflection of the screen gets brighter. Function works in the following mode - Component, HDMI, DVI-D adjusts the contrast and the brightness of the screen using the black level of the screen.

AUDIO settings

- 1 Press **MENU** to access the main menus.
- 2 Press the Navigation buttons to scroll to **AUDIO** and press **OK**.
- 3 Press the Navigation buttons to scroll to the setting or option you want and press **OK**.
- To return to the previous level, press **BACK**.
- 4 When you are finished, press **EXIT**.
When you return to the previous menu, press **BACK**.

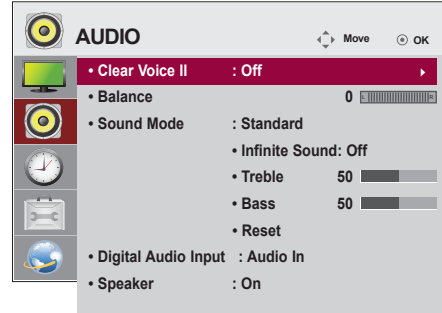

The available audio options are described in the following:

Setting	Description
Clear Voice II	By differentiating the human sound range from others, it helps users listen to human voices better.
Balance	Use this function to balance sound from the left and right speakers.
Sound Mode	The best sound tone quality will be selected automatically depending on the video type that you're currently watching.
Mode	
Standard	The most commanding and natural audio.
Music	Select this option to enjoy the original sound when listening to the music.
Cinema	Select this option to enjoy sublime sound.
Sports	Select this option to watch sports broadcasting.
Game	To enjoy dynamic sound when playing a game.
<p>NOTE</p> <p>If sound quality or volume is not at the level you want, it is recommended to use a separate home theater system or amplifier to cope with different user environments.</p>	
Option	
Infinite Sound	LG's Infinity Sound option provides 5.1 channel stereo sound from two speakers.
Treble	Controls the dominant sounds in the output. When you turn up the treble, it will increase the output to the higher frequency range.
Bass	Controls the softer sounds in the output. When you turn up the bass, it will increase the output to the lower frequency range.
Reset	Resets the sound mode to the default setting.
Digital Audio Input	HDMI: Outputs the sound of digital signals in digital input (HDMI) mode through the external monitor speaker connected to the speaker out port of the monitor. Audio In: Outputs the sound received from the Audio In port in digital input (HDMI) mode through the external speaker connected to the speaker out port of the monitor.
Speaker	*The speaker is sold separately. On: Outputs the sound through the external speaker connected to the speaker out port of the monitor. Off: Outputs the sound through the external speaker connected to the speaker out port of the monitor. Use this option when using an external sound device.

TIME settings

- 1 Press **MENU** to access the main menus.
- 2 Press the Navigation buttons to scroll to **TIME** and press **OK**.
- 3 Press the Navigation buttons to scroll to the setting or option you want and press **OK**.
 - To return to the previous level, press **BACK**.
- 4 When you are finished, press **EXIT**.
 - When you return to the previous menu, press **BACK**.

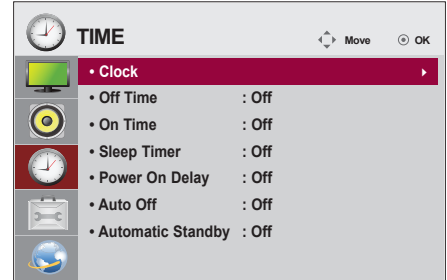

The available time settings are described in the following:

Setting	Description
Clock	Sets the time feature.
On/Off Time	Sets the time to turn on or off the Monitor set.
Sleep Timer	Sets the length of time until the Monitor set to turns off. When you turn the Monitor set off and turn it on again, the Sleep Timer will be set to off.
Power on delay	When connecting multiple monitors and turning the power on, the monitors are turned on individually to prevent overload.
Auto off	If Auto off is active and there is no input signal, the set switches to off mode automatically after 15 minutes.
Automatic Standby	If you do not use the monitor for more than 4 hours, it will be in standby mode automatically.

! NOTE

- Once the on or off time is set, these functions operate daily at the preset time.
- The scheduled power-off function works properly only when the device time is set correctly.
- When the scheduled power-on and power-off times are the same, the power-off time has priority over the power-on time if the set is turned on, and vice versa if the set is turned off.

OPTION settings

- 1 Press **MENU** to access the main menus.
- 2 Press the Navigation buttons to scroll to **OPTION** and press **OK**.
- 3 Press the Navigation buttons to scroll to the setting or option you want and press **OK**.
- To return to the previous level, press **BACK**.
- 4 When you are finished, press **EXIT**.
When you return to the previous menu, press **BACK**.

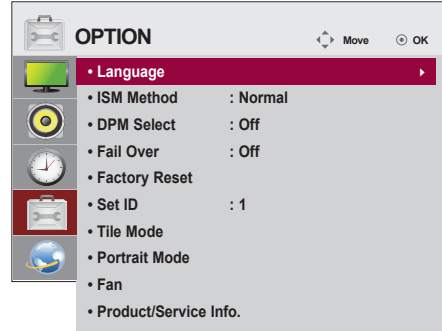

The available option settings are described in the following:

Setting	Description
Language	To choose the language in which the control names are displayed.
ISM Method	Leaving a fixed image on the screen for a long time may cause damage to the screen and cause image burn-in. To use the product for a long period of time, use a screen saver on the PC or utilize the residual image prevention function on the product, and when the product is not used, turn off the power. Burn-in and related problems are not covered by the warranty on this product.
	Setting
	Normal Sets it if image sticking is never a problem
	Orbiter May help prevent ghost images. However, it is best not to allow any fixed image to remain on the screen. To avoid a permanent image on the screen, the screen will move every 2 minutes.
	Inversion This function inverts the panel color of the screen. The panel color is automatically inverted every 30 minutes.
	White wash Removes a ghost image on the screen. Use sparingly. Watch the sets normally for a while before using this feature to see if the ghost image disappears on its own.
DPM Select	A user can choose to turn the power saving mode on / off.
Fail Over	If there is no input signal, it automatically switches to another input with signal. * 47WV30-BAAL does not support this function.
	Setting
	Off Stops auto switch of the input source.
	Auto Switches to another input source with video signal if no video signal comes from the current input source.
	Manual Selects the priority of input source for auto switch. When several input sources are found, the input source with a higher priority will be selected.
Factory Reset	Select this option to return to the default factory settings.

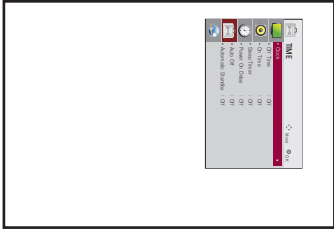
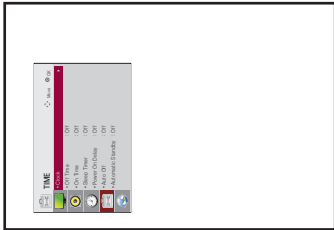
Setting	Description														
Set ID	<p>You can assign a unique Set ID NO (name assignment) to each product when several products are connected for display. Specify the number (1 to 255) using the button and exit. Use the assigned Set ID to individually control each product using the Product Control Program.</p> <div style="border: 1px solid black; padding: 5px; margin-top: 10px;"> <p>NOTE</p> <p>If you change SET ID No, the value of 'Power On Delay' will be set to (SET ID No)/3(sec) to prevent power consumption overload. ex) SET ID No = 31 → Power On Delay = 10(=31/3)</p> </div>														
Tile Mode	<table border="1" style="width: 100%; border-collapse: collapse;"> <thead> <tr> <th style="width: 20%;">Setting</th> <th></th> </tr> </thead> <tbody> <tr> <td>Tile Mode</td> <td>You can display the image on multiple sets and view it in a larger size. To use the Tile Mode on multiple sets with same signal.</td> </tr> <tr> <td>Auto Config.</td> <td>This option optimizes the screen when you connect the set to a new computer or change to a different mode. If you are not satisfied with the adjustment, you can manually change the "Position" or "Size".</td> </tr> <tr> <td>Position</td> <td>You can set the position.</td> </tr> <tr> <td>Size</td> <td>You can set the size.</td> </tr> <tr> <td>Natural</td> <td>The image is omitted by the distance between the screens to be naturally shown.</td> </tr> <tr> <td>Reset</td> <td>Function to initialize and release Tile. All Tile setting are released when selecting Tile recall and the screen returns to Full screen.</td> </tr> </tbody> </table>	Setting		Tile Mode	You can display the image on multiple sets and view it in a larger size. To use the Tile Mode on multiple sets with same signal.	Auto Config.	This option optimizes the screen when you connect the set to a new computer or change to a different mode. If you are not satisfied with the adjustment, you can manually change the "Position" or "Size".	Position	You can set the position.	Size	You can set the size.	Natural	The image is omitted by the distance between the screens to be naturally shown.	Reset	Function to initialize and release Tile. All Tile setting are released when selecting Tile recall and the screen returns to Full screen.
Setting															
Tile Mode	You can display the image on multiple sets and view it in a larger size. To use the Tile Mode on multiple sets with same signal.														
Auto Config.	This option optimizes the screen when you connect the set to a new computer or change to a different mode. If you are not satisfied with the adjustment, you can manually change the "Position" or "Size".														
Position	You can set the position.														
Size	You can set the size.														
Natural	The image is omitted by the distance between the screens to be naturally shown.														
Reset	Function to initialize and release Tile. All Tile setting are released when selecting Tile recall and the screen returns to Full screen.														
Portrait mode	<p>Rotate OSD clockwise (Off, 90°, 270°)</p> <table border="1" style="width: 100%; border-collapse: collapse;"> <thead> <tr> <th colspan="2">Option</th> </tr> </thead> <tbody> <tr> <td style="width: 20%;">Off</td> <td>Do not rotate OSD</td> </tr> <tr> <td>90°</td> <td>Rotate OSD clockwise 90°.</td> </tr> <tr> <td>270°</td> <td>Rotate OSD clockwise 270°.</td> </tr> </tbody> </table> <div style="display: flex; justify-content: space-around; margin-top: 20px;"> <div style="text-align: center;">  <p>90°</p> </div> <div style="text-align: center;">  <p>270°</p> </div> </div>	Option		Off	Do not rotate OSD	90°	Rotate OSD clockwise 90°.	270°	Rotate OSD clockwise 270°.						
Option															
Off	Do not rotate OSD														
90°	Rotate OSD clockwise 90°.														
270°	Rotate OSD clockwise 270°.														

Setting	Description		
Fan	Setting		
	<table border="0"> <tr> <td style="width: 150px;">Mode</td> <td>This option indicates the monitor's internal temperature and controls the fan. <ul style="list-style-type: none"> • Auto: Switches the fan on and off according to the set temperature. • On: The fan is always switched on. • Manual: Switches the fan on and off according to user settings. </td> </tr> </table>	Mode	This option indicates the monitor's internal temperature and controls the fan. <ul style="list-style-type: none"> • Auto: Switches the fan on and off according to the set temperature. • On: The fan is always switched on. • Manual: Switches the fan on and off according to user settings.
	Mode	This option indicates the monitor's internal temperature and controls the fan. <ul style="list-style-type: none"> • Auto: Switches the fan on and off according to the set temperature. • On: The fan is always switched on. • Manual: Switches the fan on and off according to user settings. 	
	<table border="0"> <tr> <td style="width: 150px;">Hysteresis</td> <td>The difference in temperature between when the fan is switched on and when it is off.</td> </tr> </table>	Hysteresis	The difference in temperature between when the fan is switched on and when it is off.
	Hysteresis	The difference in temperature between when the fan is switched on and when it is off.	
	<table border="0"> <tr> <td style="width: 150px;">Set Temperature</td> <td>Set the temperature at which the fan is switched on.</td> </tr> </table>	Set Temperature	Set the temperature at which the fan is switched on.
Set Temperature	Set the temperature at which the fan is switched on.		
<table border="0"> <tr> <td style="width: 150px;">Current Temperature</td> <td>Current temperature inside the set.</td> </tr> </table>	Current Temperature	Current temperature inside the set.	
Current Temperature	Current temperature inside the set.		
<div style="border: 1px solid black; padding: 10px;"> <p> NOTE</p> <ul style="list-style-type: none"> • We recommend that you use the Auto mode to prevent any malfunctions resulting from incorrect fan settings. • If the interior temperature of the set exceeds 80°C, the set will be turned off automatically for safety reasons. </div>			
Product/Service Info.	Displays the model name, software version, serial number, IP address, MAC address and home page.		

Tile Mode

This monitor can be tiled with additional monitors to create a large tiled display.

Off

When the Tile Mode option is disabled

2X1

When using 2 monitors



Tile ID

2X2

When using 4 monitors



3X3

When using 9 monitors



4X4

When using 16 monitors



5X5

When using 25 monitors



Tile Mode - Natural mode

When active, the part of the image that would normally be displayed in the gap between the monitors is omitted.

Before



After



NETWORK settings

- 1 Press **MENU** to access the main menus.
- 2 Press the Navigation buttons to scroll to **NETWORK** and press **OK**.
- 3 Press the Navigation buttons to scroll to the setting or option you want and press **OK**.
 - To return to the previous level, press **BACK**.
- 4 When you are finished, press **EXIT**.
 - When you return to the previous menu, press **BACK**.

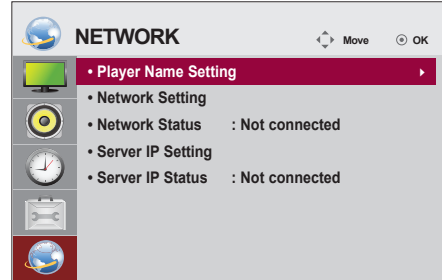

The available option settings are described in the following:

Setting	Description
Player Name Setting	Sets the player name used in SuperSign Elite-W Lite server.(Up to 20 characters)
Network Setting	Configure the network settings.
Network Status	Display the network status. - Internet is connected : Externally connected - Network is connected : Only internally connected - Not connected : When there is no network connection
Server IP Setting	Sets the IP address of the computer (server) on which SuperSign Elite-W Lite server is installed.
Server IP Status	Displays the connection status with the server. - Not connected : When there is no network connection with SuperSign Elite-W Lite server - Waiting for approval : When network connection with SuperSign Elite-W Lite server has been made, but access to server has not been approved by the server - Rejected : When network connection with SuperSign Elite-W Lite server has been made, but access to server has been rejected by the server - Internet is connected : When network connection with SuperSign Elite-W Lite server has been made and access to server has also been approved by the server

NOTE

- Network setting menu will not be available until the display connected to physical network.

MAKING CONNECTIONS

Connect various external devices to the ports on the Monitor set's back panel.

- 1 Find an external device you want to connect to your Monitor set shown in the following illustration.
- 2 Check the connection type of the external device.
- 3 Go to the appropriate illustration and check the connection details.

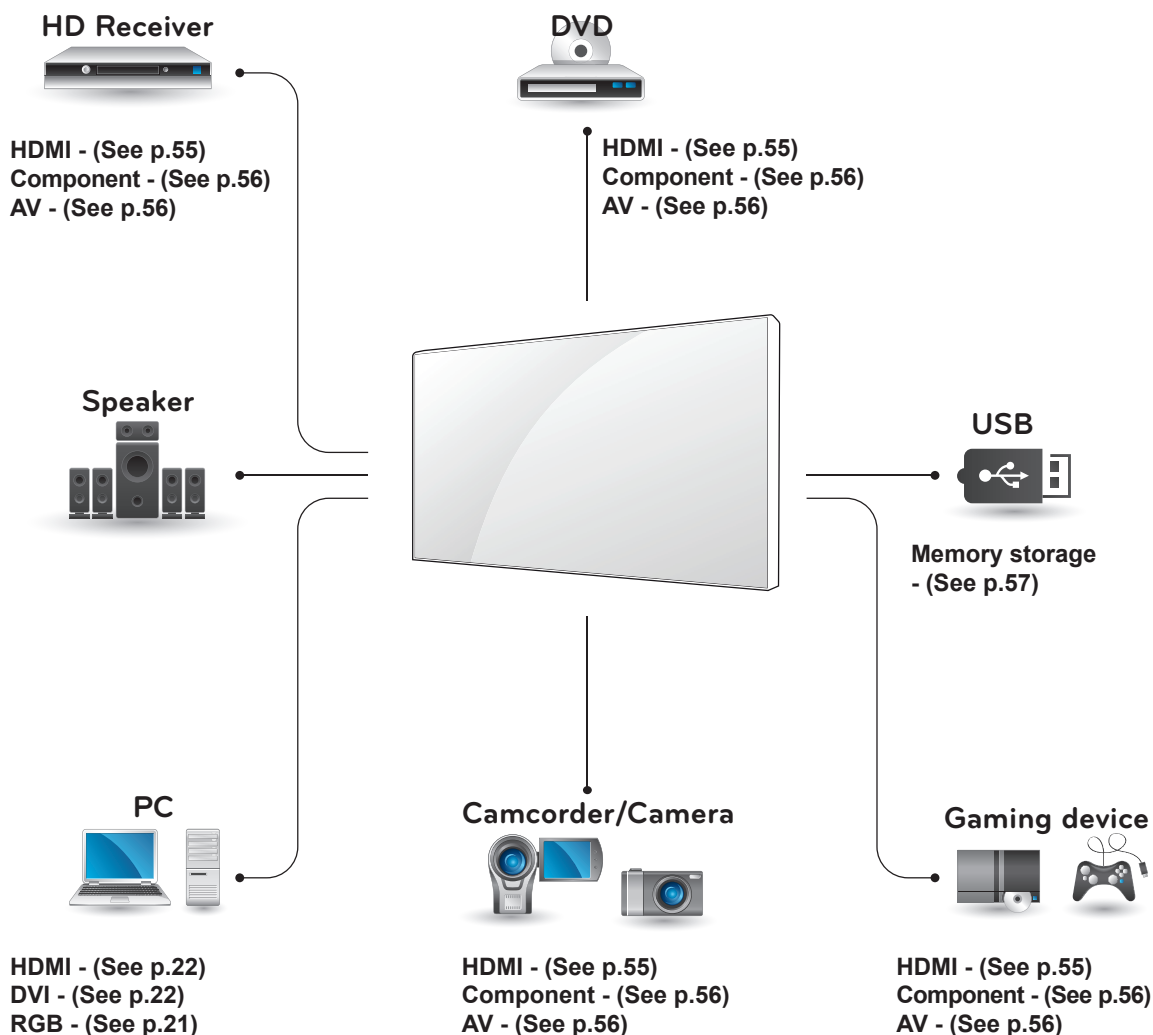

NOTE

- If you connect a gaming device to the Monitor set, use the cable supplied with the gaming device.
- AV(CVBS) can be supported only in 47WV30BR and 47WV30MS models.

Connecting to a HD receiver, DVD or VCR player

Connect a HD receiver, DVD, or VCR player to the Monitor set and select an appropriate input mode.

HDMI connection

Transmits the digital video and audio signals from an external device to the Monitor set. Connect the external device and the Monitor set with the HDMI cable as shown on the following illustration.

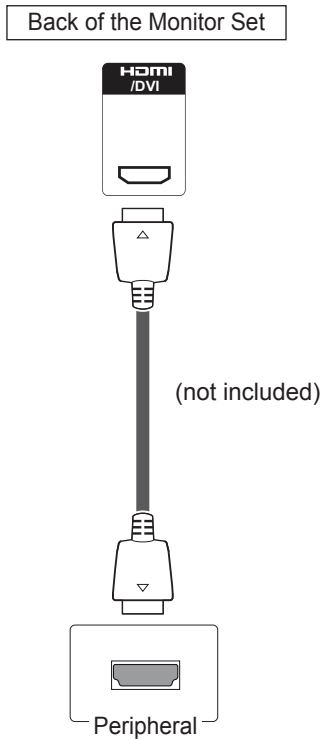

DVI - HDMI connection

Transmits the digital video signal from an external device to the Monitor set. Connect the external device and the Monitor set with the DVI-HDMI cable as shown in the following illustration. To transmit an audio signal, connect an optional audio cable.

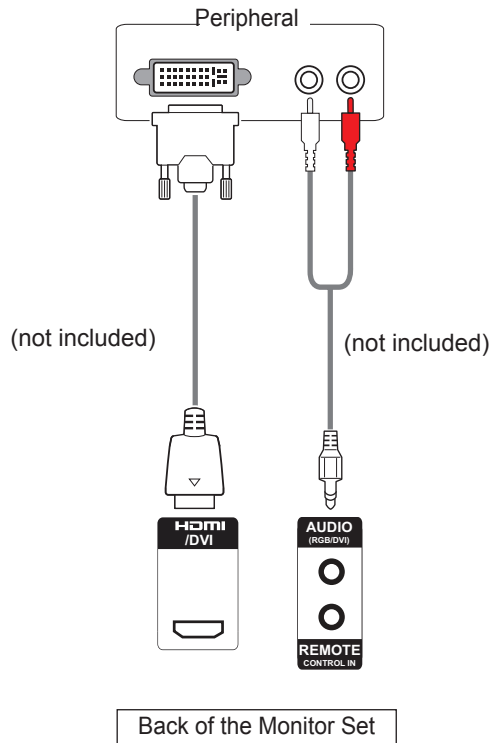

NOTE

- Use a High Speed HDMI™ Cable.
- High Speed HDMI™ Cables are tested to carry an HD signal up to 1080p and higher.
- Dolby Digital is not supported.

CAUTION

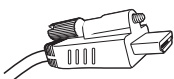

- When connecting an HDMI cable as illustrated, remove the screw on the HDMI connector first.

Component connection

Transmits the analog video and audio signals from an external device to the Monitor set. Connect the external device and the Monitor set with a component cable as shown on the following illustration. To transmit an audio signal, connect an optional audio cable.

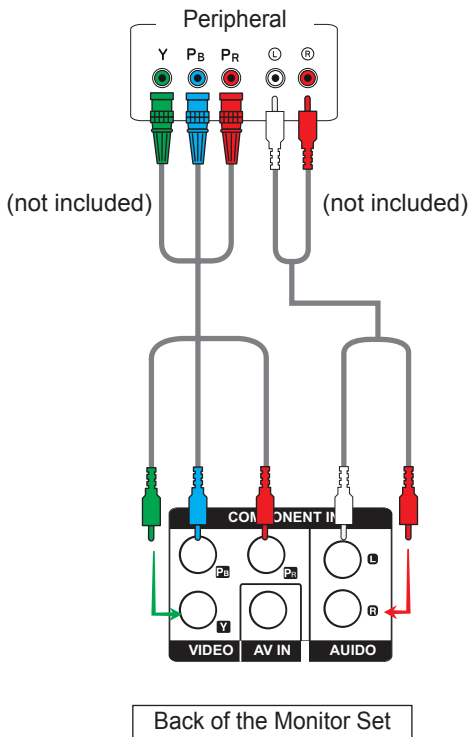

AV connection (Only 47WV30BR and 47WV30MS)

Transmits the analog video and audio signals from an external device to the Monitor set. Connect the external device and the Monitor set with the RCA cable as shown on the following illustration. To transmit an audio signal, connect an optional audio cable.

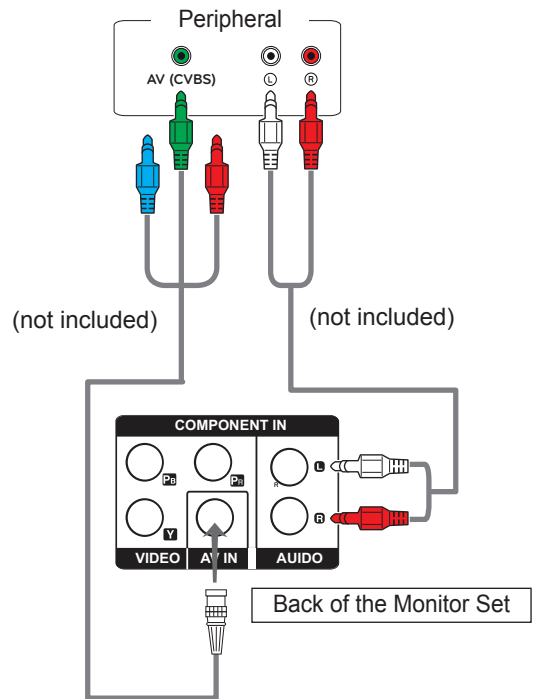

NOTE

- AV(CVBS) can be supported only in 47WV-30BR and 47WV30MS models.

NOTE

- For AV (CVBS) connection, the red and blue cables in a shared interface are not in use.
- AV(CVBS) can be supported only in 47WV-30BR and 47WV30MS models.

Connecting to the LAN

LAN connection

Connect the LAN cable.

A Using a router(Switching Hub)

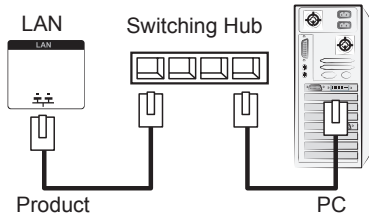

B Using the Internet.

Connecting to a USB

Connect a USB storage device such as a USB flash memory, external hard drive, MP3 player or a USB memory card reader to the Monitor set and access the USB menu to use various multimedia files. "**Connecting USB storage devices**" on See p.30 and "**Browsing files**" on See p.31

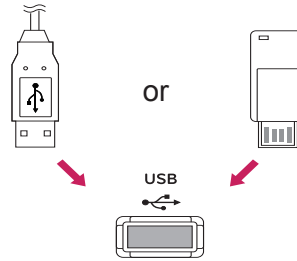

Daisy Chain Monitors

Use this function to share the RGB video signal with other monitors without having to use a separate signal splitter box.

- To use different products connected to each other Connect one end of the signal input cable (15-pin D-Sub Signal Cable) to the RGB OUT connector of product 1 and connect the other end to the RGB IN connector of other products

RGB Cable

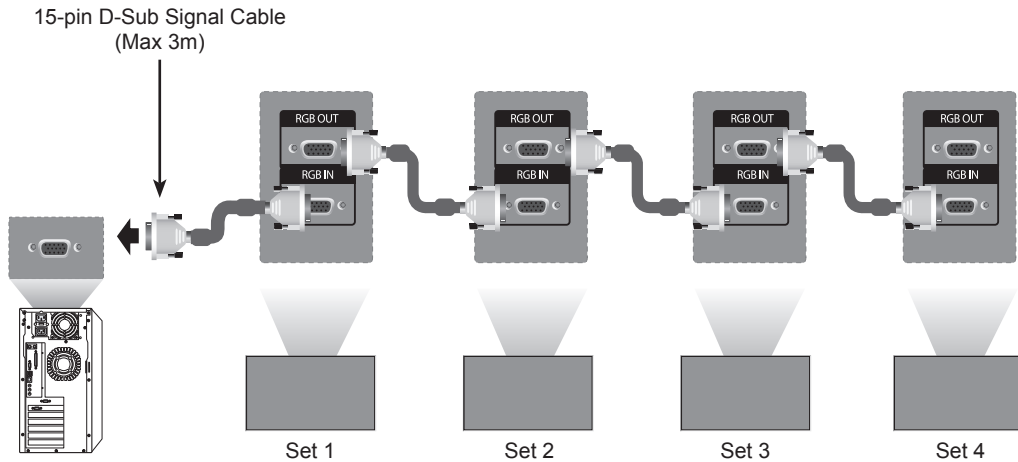

DVI Cable

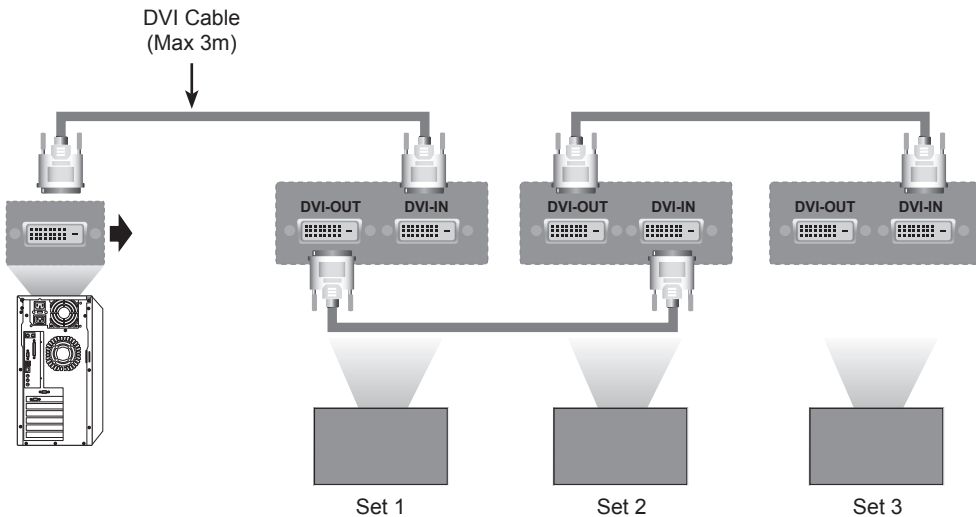

! NOTE

- "Input signal may be degraded or lost when multiple monitors are connected. For DVI, in general, up to 12 monitors can be connected via the DVI Out port (at the recommended resolution) if the signal is stable and there is no cable loss. (If you want to connect more than this number of monitors, we recommended that you use a distributor.)
- When the tile mode is configured via DVI cables, only the monitor that receives first signals can play HDCP-encrypted content. (The DVI Out port does not support HDCP).
- If the signal cable between the product and your PC is too long, make sure to use the DVI (RGB) booster or DVI (RGB) optical cable.
- If input signals are received through the HDMI/DP cable, multiple monitors cannot be connected via the DVI Out port"

TROUBLESHOOTING

No image is displayed

Problem	Resolution
Is the product power cord connected?	<ul style="list-style-type: none"> • See if the power cord is properly connected to the outlet.
Power is on, power indicator is blue but the screen appears extremely dark.	<ul style="list-style-type: none"> • Adjust brightness and contrast again. • Backlight may need repair.
Does the 'Invalid Format' message appear?	<ul style="list-style-type: none"> • The signal from the PC (video card) is out of the vertical or horizontal frequency range of the product. Adjust the frequency range by referring to the Specifications in this manual. * Maximum resolution (47WV30MS,47WV30BR) RGB : 1920 X 1080 @ 60 Hz HDMI/DVI : 1920 X 1080 @ 60 Hz * Maximum resolution (47WV30BS,47WV30-BAAM,47WV30-BAAL) RGB : 1366 X 768 @ 60 Hz HDMI/DVI : 1366 X 768 @ 60 Hz
Does the 'No Signal' message appear?	<ul style="list-style-type: none"> • The signal cable between PC and product is not connected. Check the signal cable. • Press the 'INPUT' menu in the remote Control to check the input signal.

'Unknown Product' message appears when the product is connected.

Problem	Resolution
Did you install the driver?	<ul style="list-style-type: none"> • Install the product driver, which is provided with the product, or download it from the web site. (http://www.lg.com) • See if the plug&play function is supported by referring to the video card user manual.

The screen image looks abnormal.

Problem	Resolution
Is the screen position wrong?	<ul style="list-style-type: none"> • D-Sub analog signal - Press the "AUTO" button in the remote control to automatically select the optimal screen status that fits into the current mode. If adjustment is not satisfactory, use the Position OSD menu. • See if the video card resolution and frequency are supported by the product. If the frequency is out of range, set to the recommended resolution in the Control Panel "Display" Setting menu.
Do thin lines appear on the background screen?	<ul style="list-style-type: none"> • D-Sub analog signal - Press the "AUTO" button in the remote control to automatically select an optimal screen status that fits into the current mode. If adjustment is not satisfactory, use the Clock OSD menu.
Horizontal noise appears or the characters look blurred.	<ul style="list-style-type: none"> • D-Sub analog signal - Press the "AUTO" button in the remote control to automatically select an optimal screen status that fits into the current mode. If adjustment is not satisfactory, use the Phase OSD menu.
The screen is displayed abnormally.	<ul style="list-style-type: none"> • The proper input signal is not connected to the signal port. Connect the signal cable that matches with the source input signal.

After-image appears on the product.

Problem	Resolution
After-image appears when the product is turned off.	<ul style="list-style-type: none"> • If you use a fixed image for a long time, the pixels may be damaged quickly. Use the ISM mode.

The audio function does not work.

Problem	Resolution
No sound?	<ul style="list-style-type: none"> • See if the audio cable is connected properly. • Adjust the volume. • See if the sound is set properly.
Sound is too dull.	<ul style="list-style-type: none"> • Select the appropriate equalize sound.
Sound is too low.	<ul style="list-style-type: none"> • Adjust the volume.

Screen color is abnormal.

Problem	Resolution
Screen has poor color resolution (16 colors).	<ul style="list-style-type: none"> Set the number of colors to more than 24 bits (true color) Select Control Panel - Display - Settings - Color Table menu in Windows.
Screen color is unstable or mono-colored.	<ul style="list-style-type: none"> Check the connection status of the signal cable. Or, re-insert the PC video card.
Do black spots appear on the screen?	<ul style="list-style-type: none"> Several pixels (red, green, white or black color) may appear on the screen, which can be attributable to the unique characteristics of the LCD panel. It is not a malfunction of the LCD.

The operation does not work normally.

Problem	Resolution
The power suddenly turned off.	<ul style="list-style-type: none"> Is the sleep timer set? Check the power control settings. Power interrupted.
Remote controller doesn't work.	<ul style="list-style-type: none"> Remote controller will not work in case SET ID and Picture ID are different.

SPECIFICATIONS

LCD Panel	Screen Type	1192.8 mm Wide (46.96 inch) TFT (Thin Film Transistor) LCD (Liquid Crystal Display) Panel. Visible diagonal size : 1192.8 mm
	Pixel Pitch	0.5415 mm (H) x 0.5415 mm (V)
Video Signal	Max. Resolution (47WV30MS,47WV30BR)	RGB : 1920 X 1080 @ 60 Hz HDMI/DVI : 1920 X 1080 @ 60 Hz - It may not be supported depending on the OS or video card type.
	Max. Resolution (47WV30BS,47WV30-BAAM, 47WV30-BAAL)	RGB : 1366 X 768 @ 60 Hz HDMI/DVI : 1366 X 768 @ 60 Hz - It may not be supported depending on the OS or video card type.
	Recommended Resolution	RGB : 1366 X 768 @ 60 Hz HDMI/DVI : 1366 X 768 @ 60 Hz - It may not be supported depending on the OS or video card type.
	Horizontal Frequency	RGB : 30 kHz to 68 kHz HDMI/DVI : 30kHz to 68 kHz
	Vertical Frequency	RGB : 56 Hz to 75 Hz HDMI/DVI : 56 Hz to 63 Hz
	Synchronization Type	Separate Sync, Composite Sync, Digital, SOG
Input Connector	15-pin D-Sub type(RGB), Component, HDMI/DVI(digital), AV(CVBS), RS-232C, LAN, USB * AV(CVBS) can be supported only in 47WV30BR and 47WV30MS models.	
Power	Rated Voltage	AC 100-240 V~ 50 / 60 Hz 2.2 A
	Power Consumption	On Mode : 220 W Max. Off Mode : ≤ 0.5 W
Dimensions (Width x Height x Depth) / Weight	 <p>* Wall Bracket available VESA dimensions: 800 mm x 400 mm</p>	
	1047 mm x 592 mm x 91.1 mm / 29 kg	
Environmental conditions	Operating Temperature	0 °C to 40 °C
	Operating Humidity	10 % to 80 %
	Storage Temperature	-20 °C to 60 °C
	Storage Humidity	5 % to 95 %

* Applicable only for models that support the speakers

Audio	RMS Audio Output	10 W + 10 W (R + L)
	Input Sensitivity	0.7 Vrms
	Speaker Impedance	8 Ω

Product specifications shown above may be changed without prior notice due to upgrade of product functions.

PC supported mode

Resolution		Horizontal Frequency(kHz)	Vertical Frequency(Hz)
*1	720 x 400	31.468	70.8
*2	640 x 480	31.469	59.94
*3	800 x 600	37.879	60.317
4	832 x 624	49.725	74.55
*5	1024 x 768	48.363	60
*6	1280 x 720	44.772	59.855
*7	1366 x 768	47.71	59.79
*8	1280 x 1024	63.981	60.02
*9	1360 X 768	47.72	59.799
*10	1920 X 1080	67.5	60 (Only 47WV30BR, 47WV30MS)

1 to 10: RGB Mode

* : HDMI/DVI mode

DTV Mode

Resolution	AV/Component	HDMI(DTV)
480i	o	x
576i	o	x
480p	o	o
576p	o	o
720p	o	o
1080i	o	o
1080p	x	o

RS-232 CONTROL

- You can control several products at a time by connecting them to a single PC.
- In the Option menu, Set ID must be between 1 and 255 without being duplicated.

Connecting the cable

Connect the RS-232C cable as shown in the picture.

- The RS-232C protocol is used for communication between the PC and product. You can turn the product on/off, select an input source or adjust the OSD menu from your PC. This monitor features two RS-232 ports. One input and one output. This allows you to daisy-chain monitors without having to use a splitter box.

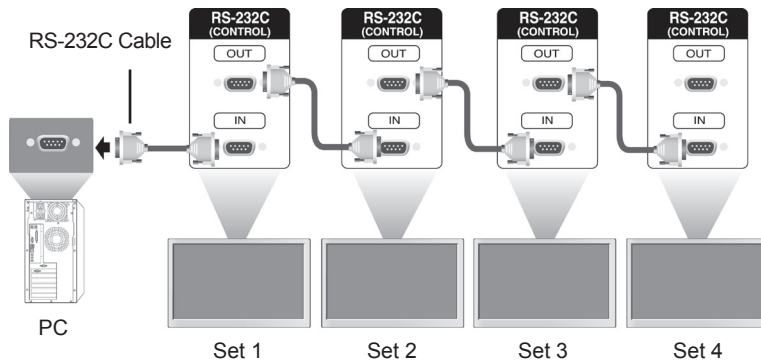

NOTE

15 mm or less

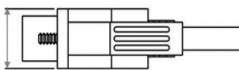

- Use RS-232C cables as shown in the picture.
- If a cable bigger than the ones shown in the picture is used in the connector, the connection may not be flawless due to interference between the cables.
- Pin 1 of RS-232C Out should be connected with Pin 4 of RS-232C In.

RS-232C Configurations

8-Wire Configurations (Cross-over RS-232C cable)

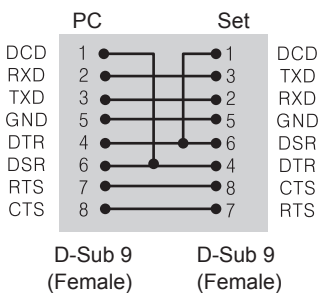

Communication Parameter

- Baud Rate : 9600 buad Rate (UART)
- Data Length : 8 bit
- Parity Bit : None
- Stop Bit : 1bit
- Flow Control : None
- Communication Code : ASCII code
- Use a crossed (reverse) cable

Command Reference List

		COMMAND		DATA (Hexadecimal)
		1	2	
01	Power	k	a	00H to 01H
02	Input Select	x	b	Refer to '02. Input Select'
03	Aspect Ratio	k	c	Refer to '03. Aspect Ratio'
04	Energy Saving	j	q	Refer to '04. Energy Saving'
05	Picture mode	d	x	00H to 04H
06	Contrast	k	g	00H to 64H
07	Brightness	k	h	00H to 64H
08	Sharpness	k	k	00H to 64H
09	Color	k	i	00H to 64H
10	Tint	k	j	00H to 64H
11	Color Temperature	x	u	00H to 64H
12	H Position	f	q	00H to 64H
13	V Position	f	r	23H to 41H
14	H Size	f	s	00H to 64H
15	Auto configuration	j	u	01H
16	Balance	k	t	00H to 64H
17	Sound mode	d	y	01H to 05H
18	Treble	k	r	00H to 64H
19	Bass	k	s	00H to 64H
20	Speaker	d	v	00H to 01H
21	Volume Mute	k	e	00H to 01H
22	Volume Control	k	f	00H to 64H
23	Time 1(Years/ Months/ Days)	f	g	Refer to '23. Time 1'
24	Time 2(Hours/ Minutes/Seconds)	f	x	Refer to '24. Time 2'
25	Off Timer(Repeat mode/ Time)	f	d	Refer to '25. Off Timer'
26	On Timer(Repeat Mode/ Time)	f	e	Refer to '26. On Timer'
27	On Timer Input	f	u	Refer to '27. On Timer Input'
28	Sleep Time	f	f	00H to 08H
29	Power On Delay	f	h	00H to 64H
30	Automatic Standby	m	n	00H to 01H
31	Auto Off	f	g	00H to 01H
32	Language	f	i	00H to 0AH
33	ISM mode	j	p	Refer to '33. ISM Method'
34	DPM Select	f	j	00H to 01H
35	Fail Over Select	m	i	00H to 02H
36	Fail Over Input Select	m	j	Refer to '36. Fail Over Input Select'
37	Reset	f	k	00H to 03H
38	Tile Mode	d	d	Refer to '38. Tile Mode'
39	Tile Mode Check	d	z	FFH
40	Tile ID	d	i	Refer to '40. Tile ID'

		COMMAND		DATA (Hexadecimal)
		1	2	
41	Tile H Position	d	e	00H to 64H
42	Tile V Position	d	f	23H to 41H
43	Tile H Size	d	g	00H to 64H
44	Natural Mode (In Tile mode)	d	j	00H to 01H
45	FAN Control	d	o	00H to 02H
46	FAN Fault check	d	w	FFH
47	Temperature Value	d	n	FFH
48	Key	m	c	Refer to '48. Key'
49	OSD Select	k	l	00H to 01H
50	Elapsed time return	d	l	FFH
51	Serial No. Check	f	y	FFH
52	S/W Version	f	z	FFH
53	White Balance Red Gain	j	m	00H to FEH
54	White Balance Green Gain	j	n	00H to FEH
55	White Balance Blue Gain	j	o	00H to FEH

- Note : During USB operations such as Dvix or EMF, all commands except Power(ka) and Key(mc) are not executed and treated as NG.

Transmission / Receiving Protocol

Transmission

[Command1][Command2][][Set ID][][Data][Cr]

- [Command1]: First command to control the set.
- [Command2]: Second Command to control the set.
- [Set ID]: Set ID wants to communicate with the set. Command for test is 00.
- [DATA]: Information passed to the set.
- [Cr]: Carriage Return. ASCII code '0x0D'.
- []: White Space. ASCII code '0x20'.

Acknowledgement

[a][][Set ID][][OK/NG][Data][x]

- In a like manner, if other functions transmit 'FF' data based on this format, Acknowledgement data feedback presents status about each function.
- Note: In this mode, display will send the acknowledgement after power on processing completion. There might be a time delay between command and acknowledgement.
- Refer to 'Real data mapping' for hexadecimal data to decimal data.
- No acknowledgement signal will be sent from display, if Set ID in transmission signal is set to '00'(=0x00).

Supports

Data	Model	
	47WV30-BAAL	47WV30BS 47WV30-BAAM 47WV30BR 47WV30MS
20H	x	o
40H	o	x
90H	o	o

- This table displays the models which the command supports(O: Supports, X: Not supports)
- The command does not have this table supports all displays.

01. Power (Command: k a)
- To control power On/Off the display.

Transmission

[k][a][][Set ID][][Data][Cr]

Data

- 00: Power Off
01: Power On

Acknowledgement

[a][][Set ID][][OK/NG][Data][x]

* Note: In this mode, display will send the acknowledgement after power on processing completion. There might be a time delay between command and acknowledgement.

02. Input Select (Command: x b)
- To select input source for display.

Transmission

[x][b][][Set ID][][Data][Cr]

Data

- 20: AV
40: Component
60: RGB PC
70: DVI-D(PC)
80: DVI-D(DTV)
90: HDMI(DTV)
A0: HDMI(PC)

Acknowledgement

[b][][Set ID][][OK/NG][Data][x]

* Use this feature depending on your model

Supports

Data \ Model	47WV30BS	47WV30BR
	47WV30-BAAM 47WV30-BAAL	47WV30MS
20H	x	o
40H	o	o
60H	o	o
70H	o	o
80H	o	o
90H	o	o
A0H	o	o

03. Aspect Ratio (Command: k c)
- To adjust the screen format.

Transmission

[k][c][][Set ID][][Data][Cr]

Data

- 01: 4:3
02: 16:9
04: Zoom
09: Just Scan(720p or higher)/ 1:1
10~1F: Cinema Zoom 1~16

Acknowledgement

[c][][Set ID][][OK/NG][Data][x]

04. Energy Saving (Command: j q)
- To control the energy saving function.

Transmission

[j][q][][Set ID][][Data][Cr]

Data

- 00: Off
01: Minimum
02: Medium
03: Maximum
05: Screen Off

Acknowledgement

[q][][Set ID][][OK/NG][Data][x]

05. Picture Mode (Comman : d x)
- To select the picture mode.

Transmission

[d][x][][Set ID][][Data][Cr]

Data

- 00: Vivid
01: Standard
02: Cinema
03: Sport
04: Game

Acknowledgement

[j][][Set ID][][OK/NG][Data][x]

06. Contrast (Command: k g)
- To adjust screen contrast.

Transmission

[k][g][][Set ID][][Data][Cr]

Data

00~64: Contrast 0~100

Acknowledgement

[g][][Set ID][][OK/NG][Data][x]

09. Color (Command: k i)

- To adjust screen color.

* Only available for AV/ Component input.

Transmission

[k][i][][Set ID][][Data][Cr]

Data

00~64: Color 0~100

Acknowledgement

[i][][Set ID][][OK/NG][Data][x]

07. Brightness (Command: k h)
- To adjust screen brightness.

Transmission

[k][h][][Set ID][][Data][Cr]

Data

00~64: Brightness 0~100

Acknowledgement

[h][][Set ID][][OK/NG][Data][x]

10. Tint (Command: k j)

- To adjust screen tint.

* Only available for AV/ Component input.

Transmission

[k][j][][Set ID][][Data][Cr]

Data

00~64: Tint 0~100 (R50 ~ G50)

Acknowledgement

[j][][Set ID][][OK/NG][Data][x]

08. Sharpness (Command: k k)
- To adjust screen sharpness.
* Only available for AV/ Component input.

Transmission

[k][k][][Set ID][][Data][Cr]

Data

00~64: Sharpness 0~100

Acknowledgement

[k][][Set ID][][OK/NG][Data][x]

11. Color Temperature (Command: x u)

- To adjust color temperature.

Transmission

[x][u][][Set ID][][Data][Cr]

Data

00~64: Warm 50~Cool 50

Acknowledgement

[u][][Set ID][][OK/NG][Data][x]

12. H Position (Command: f q)

- To set the Horizontal position.

* Only available for Tile Off mode.

Transmission

[f][q][][Set ID][][Data][Cr]

Data

00~64: Left 50 ~ Right 50

Acknowledgement

[q][][Set ID][][OK/NG][Data][x]

13. V Position (Command: f r)

- To set the Vertical position.

* Only available for Tile Off mode.

Transmission

[f][r][][Set ID][][Data][Cr]

Data

23~41: Bottom 15~Top 15

Acknowledgement

[r][][Set ID][][OK/NG][Data][x]

14. H Size (Command: f s)

- To set the Horizontal size.

* Only available for Tile Off mode.

Transmission

[f][s][][Set ID][][Data][Cr]

Data

00~64: Size -50 ~ +50

Acknowledgement

[s][][Set ID][][OK/NG][Data][x]

15. Auto Configuration (Command: j u)

- To adjust picture position and minimize image shaking automatically.

* Only available for RGB input.

Transmission

[j][u][][Set ID][][Data][Cr]

Data

01: Set

Acknowledgement

[u][][Set ID][][OK/NG][Data][x]

16. Balance (Command: k t)

- To adjust sound balance.

Transmission

[k][t][][Set ID][][Data][Cr]

Data

00~64: Left 50~Right 50

Acknowledgement

[t][][Set ID][][OK/NG][Data][x]

17. Sound Mode (Comman : d y)

- To select the sound mode.

Transmission

[d][y][][Set ID][][Data][Cr]

Data

01: Standard

02: Music

03: Cinema

04: Sport

05: Game

Acknowledgement

[y][][Set ID][][OK/NG][Data][x]

18. Treble (Command: k r)
- To adjust treble.

Transmission

[k][r][][Set ID][][Data][Cr]

Data

00~64: Treble 0~100

Acknowledgement

[r][][Set ID][][OK/NG][Data][x]

19. Bass (Command: k s)
- To adjust bass.

Transmission

[k][s][][Set ID][][Data][Cr]

Data

00~64: Bass 0~100

Acknowledgement

[s][][Set ID][][OK/NG][Data][x]

20. Speaker (Command: d v)
- To select speaker on/off.

Transmission

[d][v][][Set ID][][Data][Cr]

Data

00: Speaker Off

01: Speaker On

Acknowledgement

[v][][Set ID][][OK/NG][Data][x]

21. Volume Mute (Command: k e)
- To select volume mute on/off.

Transmission

[k][e][][Set ID][][Data][Cr]

Data

00: Volume mute on(volume off)

01: Volume mute off(volume on)

Acknowledgement

[e][][Set ID][][OK/NG][Data][x]

22. Volume Control (Command: k f)
- To adjust volume.

Transmission

[k][f][][Set ID][][Data][Cr]

Data

00~64: Volume 0~100

Acknowledgement

[f][][Set ID][][OK/NG][Data][x]

23. Time 1 (Year/ Month/ Day) (Command: f a)
- To set the Time 1 (Year/ Month/ Day) values.

Transmission

[f][a][][Set ID][][Data1][][Data2][][Data3][Cr]

Data1

00~14: 2010 ~ 2030

Data2

01~0C: January ~ December

Data3

01~1F: 1 ~ 31

* Enter "fa [Set ID] ff" for checking Time 1 values.

Acknowledgement

[a][][Set ID][][OK/NG][Data1][Data2][Data3][x]

24. Time 2(Hour/ Minute/ Second) (Command: f x)
- To set the Time 2(Hour/ Minute/ S) values.

Transmission

[f][x][][Set ID][][Data1][][Data2][][Data3][Cr]

Data1

00~17: 00 ~ 23 hours

Data2

01~3B: 00 ~ 59 minutes

Data3

01~3B: 00 ~ 59 seconds

* Enter "fx [Set ID] ff" for checking Time 2 values.

* This command won't work if Time 1 has not been set in advance.

Acknowledgement

[x][][Set ID][][OK/NG][Data1][Data2][Data3][x]

25. Off Timer(Repeat Mode/ Time) (Command: f e)
- To set the Off Timer(Repeat Mode/ Time) function.

Transmission

[f][e][][Set ID][][Data1][][Data2][][Data3][Cr]

Data1

00: Repeat Off

01: Repeat Once

02: Repeat Daily

03: Repeat from Monday to Friday

04: Repeat from Monday to Saturday

05: Repeat from Saturday to Sunday

06: Repeat on Sunday

Data2

00~17: 00 ~ 23 Hours

Data3

00~3B: 00 ~ 59 Minutes

* Enter "fe [Set ID] ff" for checking Off Timer(Repeat mode/ Time) values.

* Check if Time1 and Time2 have been set before setting this function.

Acknowledgement

[e][][Set ID][][OK/NG][Data1][Data2][Data3][x]

26. On Timer(Repeat Mode/ Time) (Command: f d)
- To set the On Timer(Repeat Mode/ Time) function.

Transmission

[f][d][][Set ID][][Data1][][Data2][][Data3][Cr]

Data1

00: Repeat Off

01: Repeat Once

02: Repeat Daily

03: Repeat from Monday to Friday

04: Repeat from Monday to Saturday

05: Repeat from Saturday to Sunday

06: Repeat on Sunday

Data2

00~17: 00 ~ 23 Hours

Data3

00~3B: 00 ~ 59 Minutes

* Enter "fd [Set ID] ff" for checking On Timer(Repeat mode/ Time) values.

* Check if Time1 and Time2 have been set before setting this function.

* On Timer Input command should be executed followed just after executing this command to set On Timer schedule properly.

Acknowledgement

[d][][Set ID][][OK/NG][Data1][Data2][Data3][x]

27. On Timer Input (Command: f u)
- To set the On Timer Input function.

Transmission

[f][u][][Set ID][][Data][Cr]

Data

20: AV
40: Component
60: RGB
70: DVI
90: HDMI

* Check if Time1, Time2, and On Timer(Repeat Mode/ Time) functions have been set before setting this function.

* On Timer(Repeat Mode/ Time) command should be executed in advance this command to set On Timer schedule properly.

Acknowledgement

[u][][Set ID][][OK/NG][Data][x]

Supports

Model	47WV30BS 47WV30-BAAM 47WV30-BAAL	47WV30BR 47WV30MS
20H	x	o
40H	o	o
60H	o	o
70H	o	o
90H	o	o

28. Sleep Time (Command: f f)
- To set sleep time.

Transmission

[f][f][][Set ID][][Data][Cr]

Data

00: Off
01: 10min.
02: 20min.
03: 30min.
04: 60min.
05: 90min.
06: 120min.
07: 180min.
08: 240min.

Acknowledgement

[f][][Set ID][][OK/NG][Data][x]

29. Power On Delay (Command: f h)
- To set the schedule delay when the power is turned on(unit: second).

Transmission

[f][h][][Set ID][][Data][Cr]

Data

00~64: 0~100sec.

Acknowledgement

[h][][Set ID][][OK/NG][Data][x]

30. Automatic Standby (Command: m n)
- To set the Automatic Standby function

Transmission

[m][n][][Set ID][][Data][Cr]

Data

00: Off
01: 4 Hours Off

Acknowledgement

[n][][Set ID][][OK/NG][Data][x]

31. Auto Off (Command: f g)
- To set the Auto Off function

Transmission

```
[f][g][ ][Set ID][ ][Data][Cr]
```

Data

- 00: Auto Off Off
01: Auto Off On

Acknowledgement

```
[g][ ][Set ID][ ][OK/NG][Data][x]
```

32. Language (Command: f i)
- To set language for OSD.

Transmission

```
[f][i][ ][Set ID][ ][Data][Cr]
```

Data

- 00: Korean
01: Chinese
02: Japanese
03: English
04: French
05: German
06: Italian
07: Portuguese
08: Spanish(EU)
09: Russian
0A: Persian

Acknowledgement

```
[i][ ][Set ID][ ][OK/NG][Data][x]
```

33. ISM Method (Command: j p)
- To select ISM method for avoiding having a fixed image remain on screen.

Transmission

```
[j][p][ ][Set ID][ ][Data][Cr]
```

Data

- 01: Inversion
02: Orbiter
04: White Wash
08: Normal

Acknowledgement

```
[p][ ][Set ID][ ][OK/NG][Data][x]
```

34. DPM Select (Command: f j)
- To select DPM(Display Power Management) to save every.

Transmission

```
[f][j][ ][Set ID][ ][Data][Cr]
```

Data

- 00: DPM Off
01: DPM On

Acknowledgement

```
[j][ ][Set ID][ ][OK/NG][Data][x]
```

35. Fail Over Select (Command: m i)
- To select Fail Over mode.
* 47WV30-BAAL does not support Fail Over Select command.

Transmission

```
[m][i][ ][Set ID][ ][Data][Cr]
```

Data

- 00: Off
01: Auto
02: Manual

Acknowledgement

```
[i][ ][Set ID][ ][OK/NG][Data][x]
```

36. Fail Over Input Select (Command: m j)

- To select fail over mode.

* Only available in Fail Over manual mode.

* 47WV30-BAAL does not support Fail Over Select command.

Transmission

[m][j][][Set ID][][Data1][][Data2][][Data3][Cr]

Data

60: RGB

70: DVI-D*

90: HDMI*

* Use 0x70 as data for DVI-D input, 0x90 as data for HDMI input, regardless their input labels.

Acknowledgement

[j][][Set ID][][OK/NG][Data1][Data2][Data3][x]

Data

1~3(Priority 1~3)

60: RGB

70: DVI-D**

90: HDMI**

** Returns 0x70 as Data for DVI-D port, 0x90 as Data for HDMI port, regardless their input labels.

37. Reset (Command: f k)

- To execute the Picture, Screen and Factory reset function,

Transmission

[f][k][][Set ID][][Data][Cr]

Data

00: Picture Reset

01: Screen Reset

02: Factory Reset

03: Audio Reset

Acknowledgement

[k][][Set ID][][OK/NG][Data][x]

38. Tile mode (Command: d d)

- To select a Tile Mode Off/ On and Tile Row/ Column size.

Transmission

[d][d][][Set ID][][Data][Cr]

Data

00 ~ FF: 1st byte - Tile Column value

2nd byte - Tile Row value

*00, 01, 10, 11 means Tile Mode Off.

Acknowledgement

[d][][Set ID][][OK/NG][Data][x]

39. Tile Mode Check (Command: d z)

- To check Tile Mode status.

Transmission

[d][i][][Set ID][][Data][Cr]

Data

FF: Check Tile Mode status

Acknowledgement

[z][][Set ID][][OK/NG][Data1][Data2][Data3][x]

Data1

00: Tile Mode Off

01: Tile Mode On

Data2

01~0F: Tile Column Value

Data3

01~0F: Tile Row Value

40. Tile ID (Command: d i)

- To set Tile ID.

Transmission

[d][i][][Set ID][][Data][Cr]

Data

01 ~ E1:Tile ID 01 ~ 225**

FF: Read Tile ID

** Data could not be set over (Tile Row) x (Tile Column)

Acknowledgement

[i][][Set ID][][OK/NG][Data][x]

41. Tile H Position (Command: d e)
 - To set the Horizontal position
 * Only available when Tile Mode On.

Transmission

[d][e][][Set ID][][Data][Cr]

Data

00~64: -50 ~ 50

Acknowledgement

[e][][Set ID][][OK/NG][Data][x]

42. Tile V Position (Command: d f)
 - To set the Vertical Position.
 * Only available when Tile Mode On.

Transmission

[d][f][][Set ID][][Data][Cr]

Data

23~41: -15 ~ 15 (for RGB)

Acknowledgement

[f][][Set ID][][OK/NG][Data][x]

43. Tile H Size (Command: d g)
 - To set the Horizontal size.
 * Only available when Tile Mode On.

Transmission

[d][g][][Set ID][][Data][Cr]

Data

00~64: -50 ~ 50

Acknowledgement

[g][][Set ID][][OK/NG][Data][x]

44. Natural Mode (in Tile Mode) (Comman : d j)
 - To assign the Tile Natural mode for Tiling function.

Transmission

[d][j][][Set ID][][Data][Cr]

Data

00: Off

01: On

Acknowledgement

[j][][Set ID][][OK/NG][Data][x]

45. FAN Control (Command: d o)
 - To set Fan control on/off.

Transmission

[d][o][][Set ID][][Data][Cr]

Data

00: Auto

01: On

02: Manual

Acknowledgement

[o][][Set ID][][OK/NG][Data][x]

46. FAN Fault Check (Command: d w)
 - To set Fan control on/off.

Transmission

[d][w][][Set ID][][Data][Cr]

Data

FF: Data should be always ff in hexadecimal.

Acknowledgement

[w][][Set ID][][OK/NG][Data][x]

47. Temperature Value (Command: d n)

- To read the inside temperature of the display.

Transmission

[d][n][][Set ID][][Data][Cr]

Data

FF: Data should be always ff in hexadecimal.

Acknowledgement

[n][][Set ID][][OK/NG][Data][x]

48. Key (Command: m c)

- To send IR remote control code.

Transmission

[m][c][][Set ID][][Data][Cr]

Data

IR_KEY_CODE

Acknowledgement

[c][][Set ID][][OK/NG][Data][x]

When display is in the standby mode, display will turn on by Power button of remote control only.

49. OSD Select (Command: k l)

- To select OSD(On Screen Display) on/off

Transmission

[k][l][][Set ID][][Data][Cr]

Data

00: OSD off

01: OSD on

Acknowledgement

[l][][Set ID][][OK/NG][Data][x]

50. Elapsed Time Return (Command: d l)

- To read the panel used time.

Transmission

[d][l][][Set ID][][Data][Cr]

Data

FF: Data should be always ff in hexadecimal.

Acknowledgement

[l][][Set ID][][OK/NG][Data][x]

* Returned data means used hours in hexadecimal.

51. Serial No. Check (Command: f y)

- To read the serial numbers.

Transmission

[f][y][][Set ID][][Data][Cr]

Data

FF: Data should be always ff in hexadecimal.

Acknowledgement

[y][][Set ID][][OK/NG][Data][x]

52. S/W Version (Command: f z)

- To read the software version.

Transmission

[f][z][][Set ID][][Data][Cr]

Data

FF: Data should be always ff in hexadecimal.

Acknowledgement

[z][][Set ID][][OK/NG][Data][x]

53. White Balance Red Gain (Command: j m)

- To adjust white balance red gain.

Transmission

[j][m][][Set ID][][Data][Cr]

Data 00~FE: Red gain 0~254

Acknowledgement

[z][][Set ID][][OK/NG][Data][x]

54. White Balance Green Gain (Command: j n)

- To adjust white balance green gain.

Transmission

[j][n][][Set ID][][Data][Cr]

Data 00~FE: Green gain 0~254

Acknowledgement

[n][][Set ID][][OK/NG][Data][x]

55. White Balance Blue Gain (Command: j o)

- To adjust white balance blue gain.

Transmission

[j][o][][Set ID][][Data][Cr]

Data 00~FE: Blue gain 0~254

Acknowledgement

[o][][Set ID][][OK/NG][Data][x]

IR CODE (Hex)	Function	Remark
08	POWER	Remocon Botton
C4	MONITOR ON	Remocon Botton
C5	MONITOR OFF	Remocon Botton
95	Everyy Saving	Remocon Botton
0B	INPUT	Remocon Botton
10	Number 0	Remocon Botton
11	Number 1	Remocon Botton
12	Number 2	Remocon Botton
13	Number 3	Remocon Botton
14	Number 4	Remocon Botton
15	Number 5	Remocon Botton
16	Number 6	Remocon Botton
17	Number 7	Remocon Botton
18	Number 8	Remocon Botton
19	Number 9	Remocon Botton
02	VOL+	Remocon Botton
03	VOL-	Remocon Botton
E0	BRIGHTNESS ^ (Page Up)	Remocon Botton
E1	BRIGHTNESS v (Page Down)	Remocon Botton
79	ARC (MARK)	Remocon Botton
4D	PSM	Remocon Botton
09	MUTE	Remocon Botton
43	MENU	Remocon Botton
99	AUTO	Remocon Botton
40	^	Remocon Botton
41	v	Remocon Botton
06	>	Remocon Botton
07	<	Remocon Botton
44	OK	Remocon Botton
28	BACK	Remocon Botton
7B	TILE	Remocon Botton
5B	EXIT	Remocon Botton
72	ID ON(Red)	Remocon Botton
71	ID OFF(Green)	Remocon Botton
63	Yellow	Remocon Botton
61	Blue	Remocon Botton
B1	■	Remocon Botton
B0	▶	Remocon Botton
BA		Remocon Botton
8F	◀◀	Remocon Botton
8E	▶▶	Remocon Botton



LG

Life's Good

To obtain the source code under GPL, LGPL, MPL and other open source licenses, that is contained in this product, please visit <http://opensource.lge.com>.

In addition to the source code, all referred license terms, warranty disclaimers and copyright notices are available for download. LG Electronics will also provide open source code to you on CD-ROM for a charge covering the cost of performing such distribution (such as the cost of media, shipping and handling) upon email request to opensource@lge.com. This offer is valid for three (3) years from the date on which you purchased the product.

Make sure to read the Safety Precautions before using the product.

Keep the Owner's Manual(CD) in an accessible place for future reference.

The model and serial number of the SET is located on the back and one side of the SET. Record it below should you ever need service.

MODEL _____

SERIAL _____

ENERGY STAR is a set of power-saving guidelines issued by the U.S. Environmental Protection Agency(EPA).



As an ENERGY STAR Partner LGE U. S. A.,Inc. has determined that this product meets the ENERGY STAR guidelines for energy efficiency.

! NOTE

- ENERGY STAR(EPA) can not be supported in 47WV30-BAAL model.

	ENERGY STAR(EPA) support
47WV30MS	o
47WV30BR	o
47WV30BS	o
47WV30-BAAM	o
47WV30-BAAL	x

Temporary noise is normal when powering ON or OFF this device.