



LG

Life's Good

OWNER'S MANUAL

Video Conference System

Please read this manual carefully before operating your set and retain it for future reference.

MODEL
V5000
V5500
VR5010H



MFL66683323

1303 (V1.6)

1 Safety Information



CAUTION

**RISK OF ELECTRIC SHOCK
DO NOT OPEN**



CAUTION: TO REDUCE THE RISK OF ELECTRIC SHOCK
DO NOT REMOVE COVER (OR BACK)
NO USER-SERVICEABLE PARTS INSIDE
REFER SERVICING TO QUALIFIED SERVICE PERSONNEL.



This lightning flash with arrowhead symbol within an equilateral triangle is intended to alert the user to the presence of uninsulated dangerous voltage within the product's enclosure that may be of sufficient magnitude to constitute a risk of electric shock to persons.



The exclamation point within an equilateral triangle is intended to alert the user to the presence of important operating and maintenance (servicing) instructions in the literature accompanying the product.

FCC WARNING: This equipment may generate or use radio frequency energy. Changes or modifications to this equipment may cause harmful interference unless the modifications are expressly approved in the instruction manual. The user could lose the authority to operate this equipment if an unauthorized change or modification is made.

REGULATORY INFORMATION: FCC Part 15

This equipment has been tested and found to comply with the limits for a Class A digital device, pursuant to Part 15 of the FCC Rules. These limits are designed to provide reasonable protection against harmful interference when the equipment is operated in a commercial environment.

This equipment generates, uses, and can radiate radio frequency energy and, if not installed and used in accordance with the instruction manual, may cause harmful interference to radio communications.

Operation of this equipment in a residential area is likely to cause harmful interference in which case the user will be required to correct the interference at his own expense.

- A suitable conduit entries, knock-outs or glands shall be provided in the cable entries of this product in the end user.
- Caution: Danger of explosion if battery is incorrectly replaced. Replaced only with the same or equivalent type recommended by the manufacturer. Dispose of used batteries according to the manufacturer's instructions.

- Holes in metal, through which insulated wires pass, shall have smooth well rounded surfaces or shall be provided with brushings.

This Class A digital apparatus complies with Canadian ICES-003. Cet appareil numérique de la classe A est conforme à la norme NMB-003 du Canada.

Warning: Do not install this equipment in a confined space such as a bookcase or similar unit.

Warning: Wiring methods shall be in accordance with the National Electric Code, ANSI/NFPA 70.

Warning: This is a class A product. In a domestic environment this product may cause radio interference in which case the user may be required to take adequate measures.

Warning: To reduce a risk of fire or electric shock, do not expose this product to rain or moisture.

Caution: This installation should be made by a qualified service person and should conform to all local codes.

Caution: To avoid electrical shock, do not open the cabinet. Refer servicing to qualified personnel only.

Caution: The apparatus should not be exposed to water (dripping or splashing) and no objects filled with liquids, such as vases, should be placed on the apparatus.

To disconnect power from mains, pull out the mains cord plug. When installing the product, ensure that the plug is easily accessible.



LG Electronics hereby declares that this/these product(s) is/are in compliance with the essential requirements and other relevant provisions of Directive 2004/108/EC, 2006/95/EC, and 2011/65/EU.

Contact office for compliance of this product :

LG Electronics Inc.
EU Representative, Krijgsman 1,
1186 DM Amstelveen, The Netherlands

Disposal of your old appliance



1. When this crossed-out wheeled bin symbol is attached to a product it means the product is covered by the European Directive 2002/96/EC.
 2. All electrical and electronic products should be disposed of separately from the municipal waste stream via designated collection facilities appointed by the government or the local authorities.
 3. The correct disposal of your old appliance will help prevent potential negative consequences for the environment and human health.
 4. For more detailed information about disposal of your old appliance, please contact your city office, waste disposal service or the shop where you purchased the product.
- EEE Compliance with Directive. (for Turkey only)
 - The equipment complies with requirements of the Technical Regulation, in terms of restrictions for the use of certain dangerous substances in electrical and electronic equipment. (for Ukraine only)

Safety way to remove the battery or the battery from the equipment:

Remove the old battery or battery pack, follow the steps in reverse order than the assembly. To prevent contamination of the environment and bring on possible threat to human and animal health, the old battery or the battery put it in the appropriate container at designated collection points. Do not dispose of batteries or battery together with other waste. It is recommended that you use local, free reimbursement systems batteries and accumulators. The battery shall not be exposed to excessive heat such as sunshine, fire or the lile.

Disposal of waste batteries/accumulators



1. When this crossed-out wheeled bin symbol is attached to batteries/accumulators of Your product it means they are covered by European Directive 2006/66/EC.
2. This symbol may be combined with chemical symbols for mercury(Hg), cadmium(Cd) or lead(Pb) if the battery Contains more that 0.0005% of mercury, 0.002% of cadmium or 0.004% of lead.
3. All batteries/accumulators should be disposed separately from the municipal waste stream via designated collection facilities appointed by the government or the local authorities.
4. The correct disposal of Your old batteries/accumulators will help to prevent potential negative consequences for the environment, animal and human health.
5. For more detailed information about disposal of Your old batteries/accumulators, please contact Your city office, waste disposal service or the shop where You purchased the product.

IMPORTANT SAFETY INSTRUCTIONS

1. Read these instructions.
2. Keep these instructions.
3. Heed all warnings.
4. Follow all instructions.
5. Do not use this apparatus near water.
6. Clean only with dry cloth.
7. Do not block any ventilation openings. Install in accordance with the manufacturer's instructions.
8. Do not install near any heat sources such as radiators, heat registers, stoves, or other apparatus (including amplifiers) that produce heat.
9. Do not defeat the safety purpose of the polarized or grounding-type plug. A polarized plug has two blades with one wider than the other. A grounding type plug has two blades and a third grounding prong. The wide blade or the third prong are provided for your safety. If the provided plug does not fit into your outlet, consult an electrician for replacement of the obsolete outlet.
10. Protect the power cord from being walked on or pinched particularly at plugs, convenience receptacles, and the point where they exit from the apparatus.
11. Only use attachments/accessories specified by the manufacturer.
12. Use only with the cart, stand, tripod, bracket, or table specified by the manufacturer, or sold with the apparatus. When a cart is used, use caution when moving the cart/apparatus combination to avoid injury from tip-over.
13. Unplug this apparatus during lightning storms or when unused for long periods of time.
14. Refer all servicing to qualified service personnel. Servicing is required when the apparatus has been damaged in any way, such as power-supply cord or plug is damaged, liquid has been spilled or objects have fallen into the apparatus, the apparatus has been exposed to rain or moisture, does not operate normally, or has been dropped.



Safety Warnings and Cautions

The following are warnings and cautions for the safety of the users and for the prevention of any property damage. Please read the following carefully. The safety instructions are divided into "Warning" and "Caution" and below is the definition.

- Warning: When you violate the instructions, it probably results in serious injury or death.
- Caution: When you violate the instructions, minor injury or damage that may occur.



WARNING

- Turn off the system before installation. Do not plug in several electric devices to the same outlet.
 - This may cause over heating, fire, or electric shock.
- Do not place any liquid container on the system, such as water, coffee, or other beverage.
 - If liquid is poured into the system, it can cause a system breakdown or fire.
- Prevent the power cable from being severely bent or having pressure exerted on it by a heavy object.
 - This may cause fire.
- Dust around the system on a regular basis. When cleaning the system, always use a dry cloth. Do not use a wet cloth or other organic solvents.
 - This may damage the surface of the system and can cause a system breakdown or electric shock.
- Avoid placing the system near moisture, dust, or soot.
 - This can cause fire or electric shock.
- When pulling the power cable from the plug, do so gently. Do not touch the plug with wet hands and avoid using the plug if the holes in the outlet are too loose.
 - This may cause fire or electric shock.
- Do not attempt to disassemble, repair, or modify the system on your own without seeking assistance from LG Electronics. It is extremely dangerous due to the high voltage running through the system.
 - This may cause fire, electric shock, or serious injury.
- Check for any danger signs such as a wet floor, a loosened or damaged power cable, or an unstable surface. If you encounter any problems, ask your dealer for assistance.
 - This may cause fire or electric shock.
- Install the system in a place with sufficient air ventilation. Keep at least 15 cm between the back of the system and the wall for the cables connected to the system, otherwise they may be bent, damaged, or cut.
 - This may cause fire, electric shock, or injury.
- Install the system in a cool place without direct sunlight and always maintain room temperature. Avoid candlelight and heat generating devices such as heaters. Keep the system away from places where many people pass.
 - This may cause fire.
 - Recommended operating temperature is over 0 °C (32 °F).
- Install the system on a plain surface with sufficient air ventilation. Do not place the system on an elevated surface.
 - This may cause system breakdown or serious injury.
- The power outlet must be placed on the ground, and the voltage range must be within 10 % of the voltage rate. Do not use the same outlet with a hair dryer, iron, refrigerator, or any heating appliances.
 - This may cause fire, over heating or electric shock.
- Do not touch power cords and signal cables while thunder and lightning.
 - This can cause electric shock.
- Do not disconnect power cord during using.
 - This may cause electric shock to product.
- Do not turn on or off the product by using power plug. (Do not use power plug as switch. This may cause electric shock or malfunction)
- If you are not used for a long time, separate from its power cord.
 - Dust accumulation may cause due to leakage, electric shock or fire due to heat, fire and insulation degradation due to leakage, electric shock or fire.
- When transporting the product, be sure to turn off and disconnect all cables connected to pins and transport.
 - This may cause a electric shock and system breakdown.

- Main blocking device of power supply is power cord, this blocking device must be in a location that can be easily manipulated. The product is connected to AC wall power, the switch is turned off when AC power is not completely blocked. Disconnecting the power supply should be '0' power consumption.
- The product has been dropped or the case is broken, turn off the power and unplug the power cord.
 - This may cause fire or electric shock. Please contact Service center.
- If the product has no video out or sound, please stop using. Unplug the power cable immediately and contact the service center.
 - This may cause fire or electric shock.



CAUTION

Please beware of the following precautions before installing the VCS.

- Keep the system turned off before installation.
- Keep the product away from electric sparks or magnetic substances.
- Avoid temperature extremes. (Recommended operating temperature is between 0 °C and 40 °C)
- Ensure enough space is left for cable connections.
- Place the system on a solid surface with sufficient air ventilation. Avoid any surface that vibrates.
- Placing the system near electronic devices such as a radio may cause the product to breakdown.
- Prevent any substances from being inserted into the system.
 - This may cause system breakdown.
- Do not install the system in a place with high magnetic, electric wave, or wireless devices such as a radio.
 - Do not install the system in a place with magnetic objects, electric frequencies, or vibration.
- Do not place any heavy object on the system.
 - This may cause system breakdown.
- Install the system on a stable, level surface.
 - The system may not operate properly.
- Install the system in a place with appropriate moisture and temperature levels.
 - Avoid installing the system in a place with high (over 40 °C) or low (under 0 °C) temperature.
- The system can be damaged from a strong impact or vibration. Avoid throwing objects within the vicinity of the system.
- Avoid direct sunlight or any heating appliances.
- Ventilate the air inside the system operation room, and tighten the system cover firmly.
 - System breakdown may be caused by an inappropriate environment. It is recommended to use AVR (Automatic Voltage Regulator) for a stable power supply. It is recommended to coil the core-ferrite around the connector of the system to avoid electromagnetic interference.
- The outlet must be placed on the ground.
- If there is strange sound or smell, unplug the power cable immediately and contact the service center.
 - This may cause fire or electric shock.
- In order to maintain stable system performance, have your system checked regularly by the service center.
 - LG Electronics is not held responsible for system breakdown caused by user mishandling.
 - There is a risk of explosion if a battery is replaced by an incorrect type. Dispose of used batteries according to the instructions.
- Do not overturn the product during use.
- Do not use or place near flammable materials.
 - This may cause explosion or fire.
- If you use only a specific screen for a long time, it may remain badly damaged. Use a screen saver mode.
- The device as business type EMC Equipment (A grade), the seller or the user should be operated outside of the home is intended to be used in.

Table of Contents

1 Safety Information

- 3 IMPORTANT SAFETY INSTRUCTIONS
- 4 Safety Warnings and Cautions

2 Preparation

- 8 Introduction
 - 8 What is the VCS?
 - 8 Features
 - 9 Unpacking
- 10 Codec Unit Overview
- 11 HD Camera Overview
- 12 Remote Control
 - 12 Before Using the Remote Control
 - 13 Remote Control Functions

3 Installation

- 14 Connections
 - 14 Precautions
 - 14 Connection Overview
 - 15 HDMI Connection
 - 16 HD Camera Connection
 - 17 PC Connection
 - 18 Connecting to a Network
 - 19 Connecting an Audio device
 - 20 Connecting a Microphone
 - 21 Connecting Power
 - 21 System Connection Check
 - 22 Using the CODEC UNIT STAND
- 24 Initial Settings
- 27 Main Screen Overview
- 28 System Configuration Menu
- 29 User Settings
 - 29 General
 - 30 Camera
 - 31 Date Time
- 32 Admin Settings
 - 32 Call Settings
 - 36 Network Settings
 - 42 System Settings
- 44 System Information
 - 44 System Status
 - 44 Video
 - 45 Audio
 - 45 Network Utility
 - 46 Server Status

4 Operation

- 47 Before Using the System
- 47 Placing a Call
 - 47 Placing a Call Manually
 - 48 Multipoint Call (V5500 Only)
 - 48 Placing a Call from the Call History
 - 49 Placing a Call from the Directory
 - 49 Placing a Call using the Speed Dial
- 49 Answering or Rejecting a Call
- 49 Managing a Call
 - 49 Ending a Call
 - 49 Hiding or Showing User Interface Elements
 - 50 Managing Audio
 - 50 Managing Video Layout
 - 51 Managing Video Contents
 - 53 Viewing Call Information
 - 53 Get the Snapshot
- 54 Managing the Directory
 - 54 Adding an Entry to the Directory
 - 55 Editing or Deleting an Entry from the Directory
 - 55 Copying an Entry from the Call History
 - 55 Copying an Entry from the Corporate Contact
 - 56 Deleting an Entry from the Call History
 - 56 Sorting and Searching
 - 56 Placing a Call when the Device is Registered in Gatekeeper Server
 - 56 Making a Call when the Device is Registered in SIP Server
 - 57 Using the Camera Control
 - 57 Using Preset function
 - 58 Using SnapShot
 - 58 Using Power Off
- 59 Using the Web Service
 - 59 Login the web service
 - 60 Using the web monitoring function
 - 61 Using the web recording function
 - 62 Upgrading your System Software
 - 62 Uploading the Certification File
 - 63 Importing or Exporting the Address Book

5 Appendix

- 64 Troubleshooting
- 66 Open Source Software Notice
- 67 Specifications

2 Preparation

Introduction

What is the VCS?

The LG VCS (Video Conference System) is designed to be used for video conferencing that enables people in different places to have a meeting by seeing, listening and speaking to each other on a screen.

Through this device, not only can executives or managers have a meeting and communicate with customers, subcontractors and coworkers in real time but decisions can be made and information can be exchanged virtually and immediately, saving travel time, cost and energy.

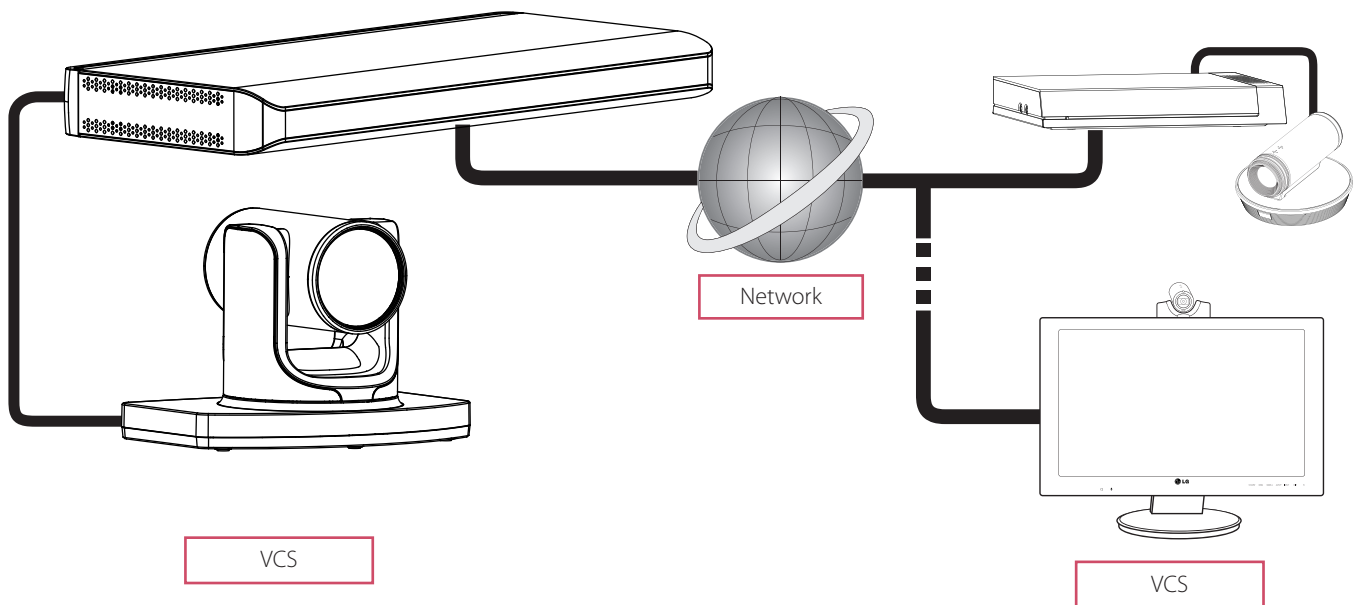

Features

- Convenient and easy graphical user interface
- H.323 / SIP network International Standard codec
- HD video quality – 1 280 X 720 (30 fps)
- Selectable screen layouts
- Graphic presentation using Content Sharing Function
- Administrator password for security
- One-touch call connection using speed dial
- Graphical directory using snapshot and specific group management
- Easy phonebook search function
- 720p high-definition camera
- Natural sounding conversation using full duplex mode
- 3.5 mm Micpod with Mute
- Pan/Tilt/Zoom control of the camera

Unpacking

Check your product box for the following items. If there are any missing accessories, contact the local dealer where you purchased your product. The illustrations in this manual may differ from the actual product and item.

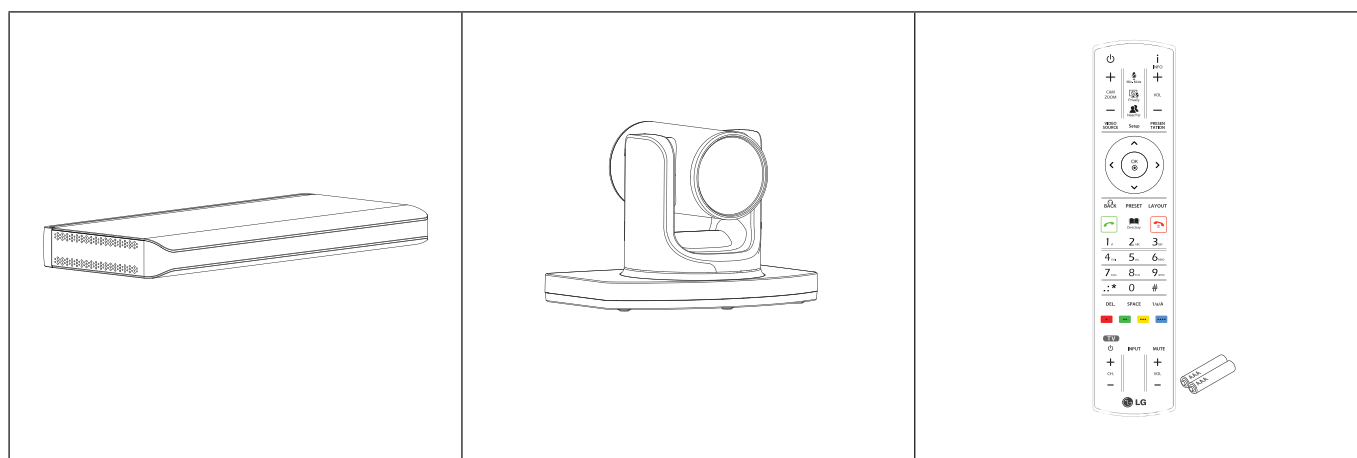

Codec Unit

HD Camera

Remote Control and Batteries

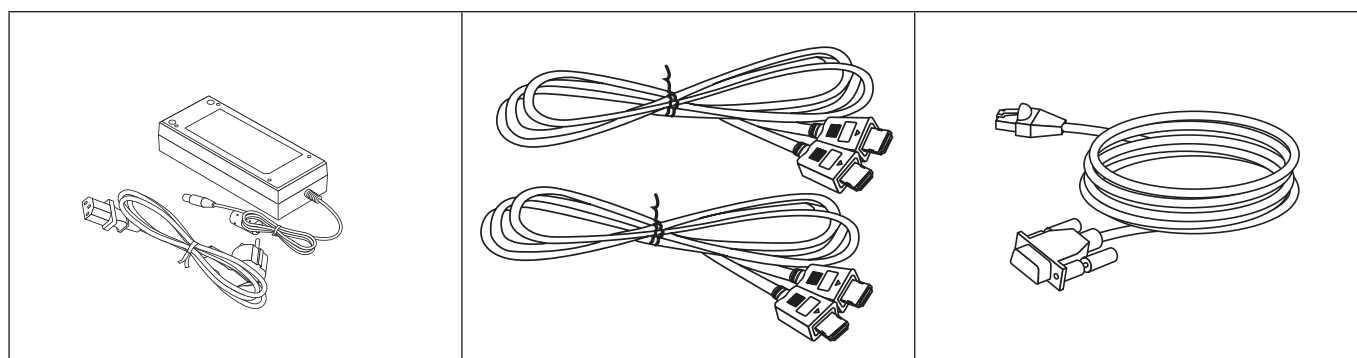

Power Adapter

HDMI Cable

Camera Connection Cable

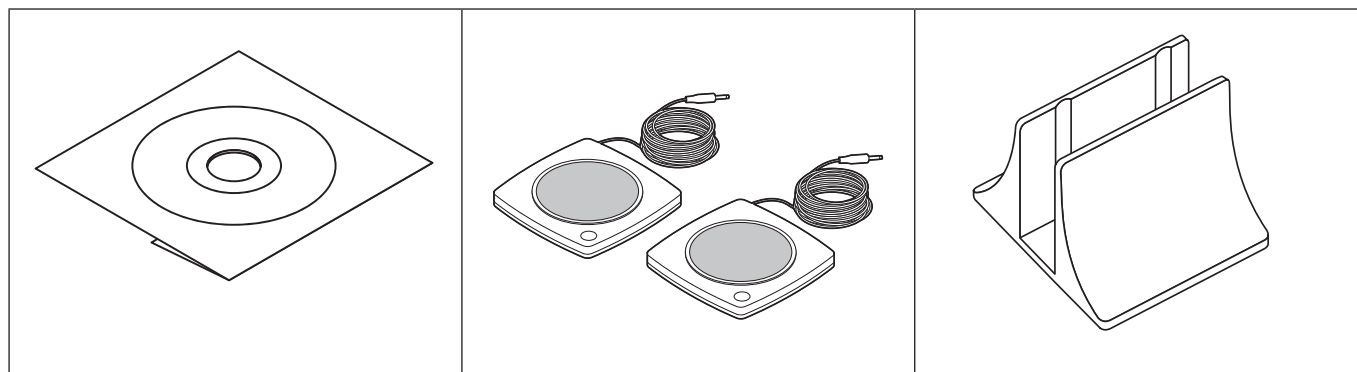

Owner's Manual CD

MicPod

Codec Unit Stand



Quick Setup Guide

Codec Unit Overview

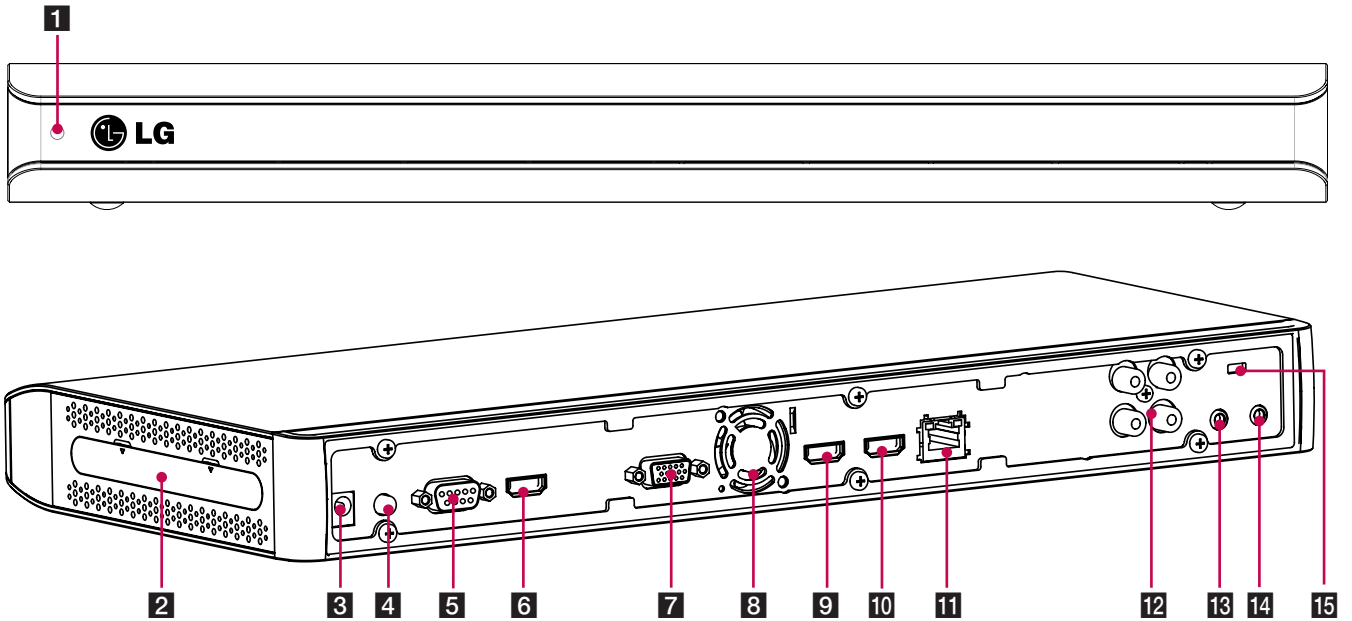

- 1** Power indicator: Lights when the unit turns on.
- 2** If you use the codec unit as stand type, attach the codec unit to the codec unit stand. For more details, refer to 22 page.
- 3** Power input jack: Connects to a DC 12 V power supply using proper cables.
- 4** Power button: Turns the unit on or off. You must turn the unit on using the Power button after connecting the power cable. You can use this button to reset the system.
- 5** Camera connection port: Connects the HD camera.
- 6** HDMI Input port: Connects the codec unit and the camera with a HDMI cable.
- 7** RGB(PC) IN port: Connects the PC with a D-sub cable for presentation.
- 8** Cooling fan.
- 9** HDMI OUT 1 port: Connects the codec unit and the display device with a HDMI cable for main output.
- 10** HDMI OUT 2 port: Connects the codec unit and the display device with a HDMI cable for contents output.
- 11** LAN port: Connects to a network via a hub with RJ-45 connector.
- 12** AUDIO IN/OUT: Connects to the external audio device.
- 13** Microphone jack 1: Connects a microphone.
- 14** Microphone jack 2: Connects a microphone.
- 15** LOCK: Connects the Kensington security system cable between the Codec Unit and a large object such as a desk.

HD Camera Overview

V5000

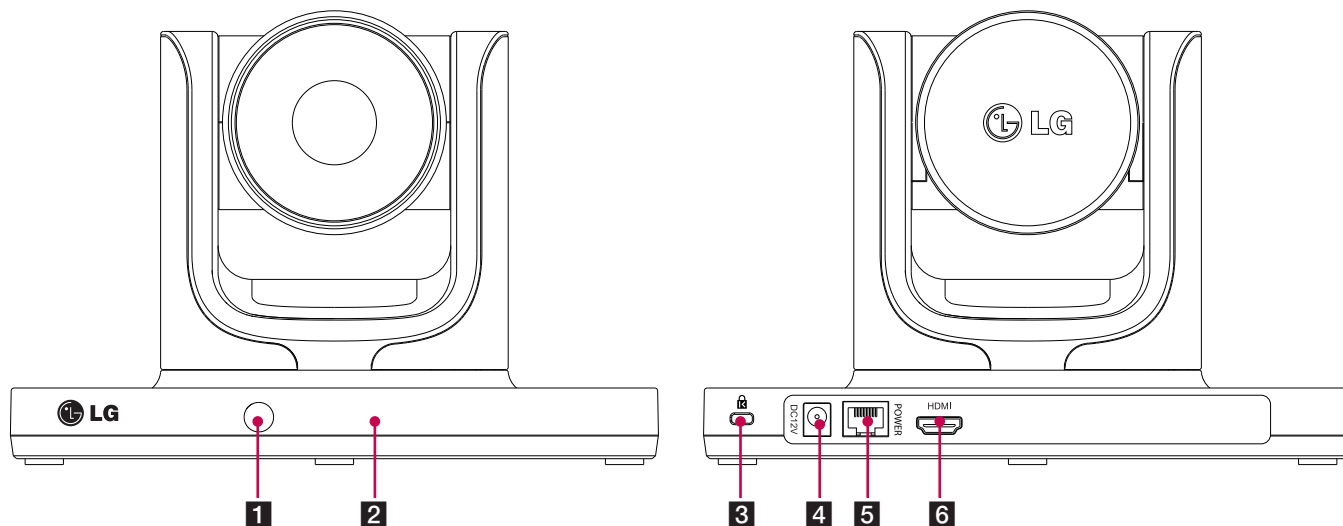

VR5010H

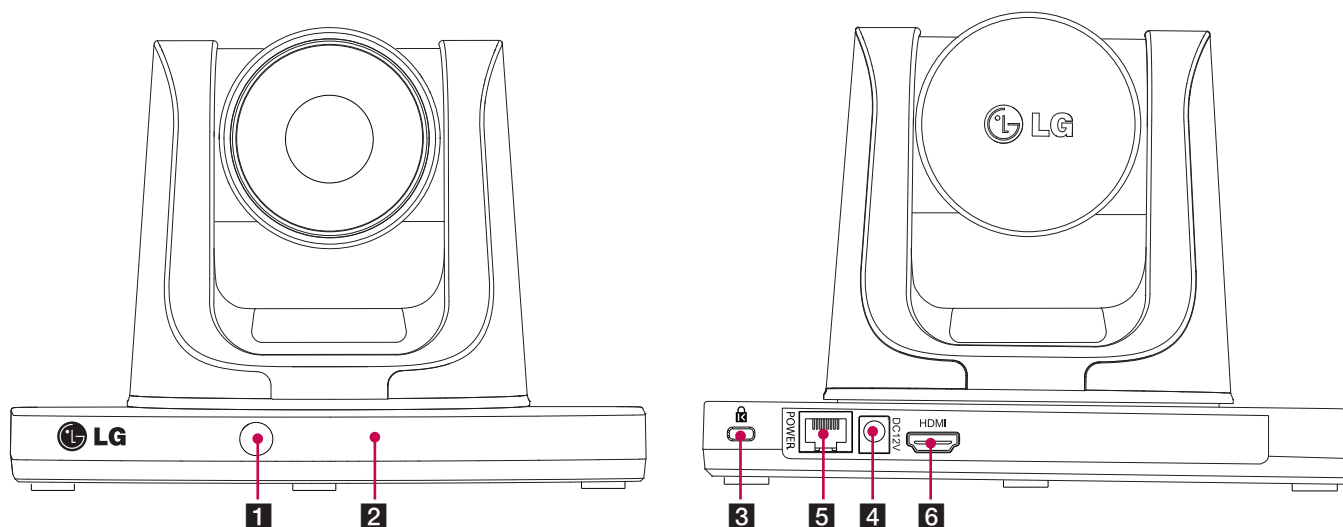

- 1** Remote sensor: Point the Remote control here.
- 2** Camera activation indicator: Lights when the camera is connected to the codec unit and activates correctly.
- 3** LOCK: Connects the Kensington security system cable between the Camera and a large object such as a desk.
- 4** Power input jack: Connects to a DC 12 V power supply using proper cables.
- 5** RJ-45 connection port: Connects the codec unit and the HD camera with the supplied camera connection cable. It enables power to be provided to the camera and communicate with codec unit. The camera is operated without external power supply when the camera and codec unit are connected with the supplied Camera connection cable.
- 6** HDMI port: Connects the codec unit and the camera with a HDMI cable.

Remote Control

This remote control provides wireless control of all video conference system functions and enables you to navigate the user interface, place and receive calls and control the far end of the camera connected to the system.

Before Using the Remote Control

Open the battery cover, replace batteries (1.5 V AAA) matching ⊕ and ⊖ ends to the label inside the compartment and then close the battery cover.



CAUTION

Do not mix old and new batteries as this may damage the Remote Control.

Remote Control Functions

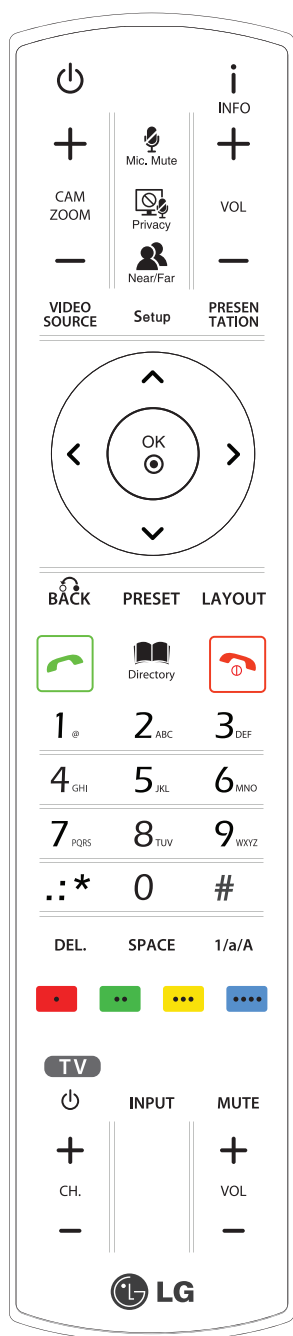

Button	Description	Button	Description
	Changes the unit to idle (ON) or standby (OFF) mode. For more details by using the power off, refers 58 page.		Displays the system or call information.
	Use this button to zoom in or zoom out of the near end and the far end camera.		Use this button to adjust the volume of the system in a call.
	Use this button to mute microphones of the near end system.		If you press this button during a call, the camera image will be displayed to the opposite sides of the current camera position and mute the microphones of the near end system.
	Use this button to select the near or far end camera. You can use the below functions. <ul style="list-style-type: none"> Preset setting PTZ control Selects a video source 		Use this button to select the video input source (camera or PC) of the near camera.
	Displays the system setup menu.		Use this button to enable the presentation function.
	<ul style="list-style-type: none"> Arrow buttons: Navigate the menu options. Use this button to Pan/Tilt control for far end camera. OK: Confirms menu selections. 		Use this button to return to the previous condition.
	Use this button to set the far end camera preset.		Use this button to change the screen layout.
	Use this button when you want to make a call.		Displays the directory menu.
	Use this button when you want to hang up the call.		Function buttons. Each button function changes as the condition of the menu and system operation refers to the each screen for more details.
	Use these buttons to input text or numbers. <ul style="list-style-type: none"> DEL.: Delete a character before the cursor position. SPACE: Insert a space at the cursor position. 1/a/A: Change the input type among the number, lower case and upper case. 		Use these buttons to control the LG TV. If you want to use this function, the VCS is connected with HDMI TV via the HDMI Output 1 port. <ul style="list-style-type: none"> : Turns the TV power On or Off. CH. +/-: Use this button to change the channel. INPUT: Selects the input source. MUTE: To mute the sound. VOL +/-: Use this button to adjust the volume of the TV.

3 Installation

Connections

Precautions

Before setting up the system, ensure that the monitor, the computer system and other attached devices are turned off.

Connection Overview

The illustration below shows the connections of the system. For specific information of each connection, refer to the next pages.

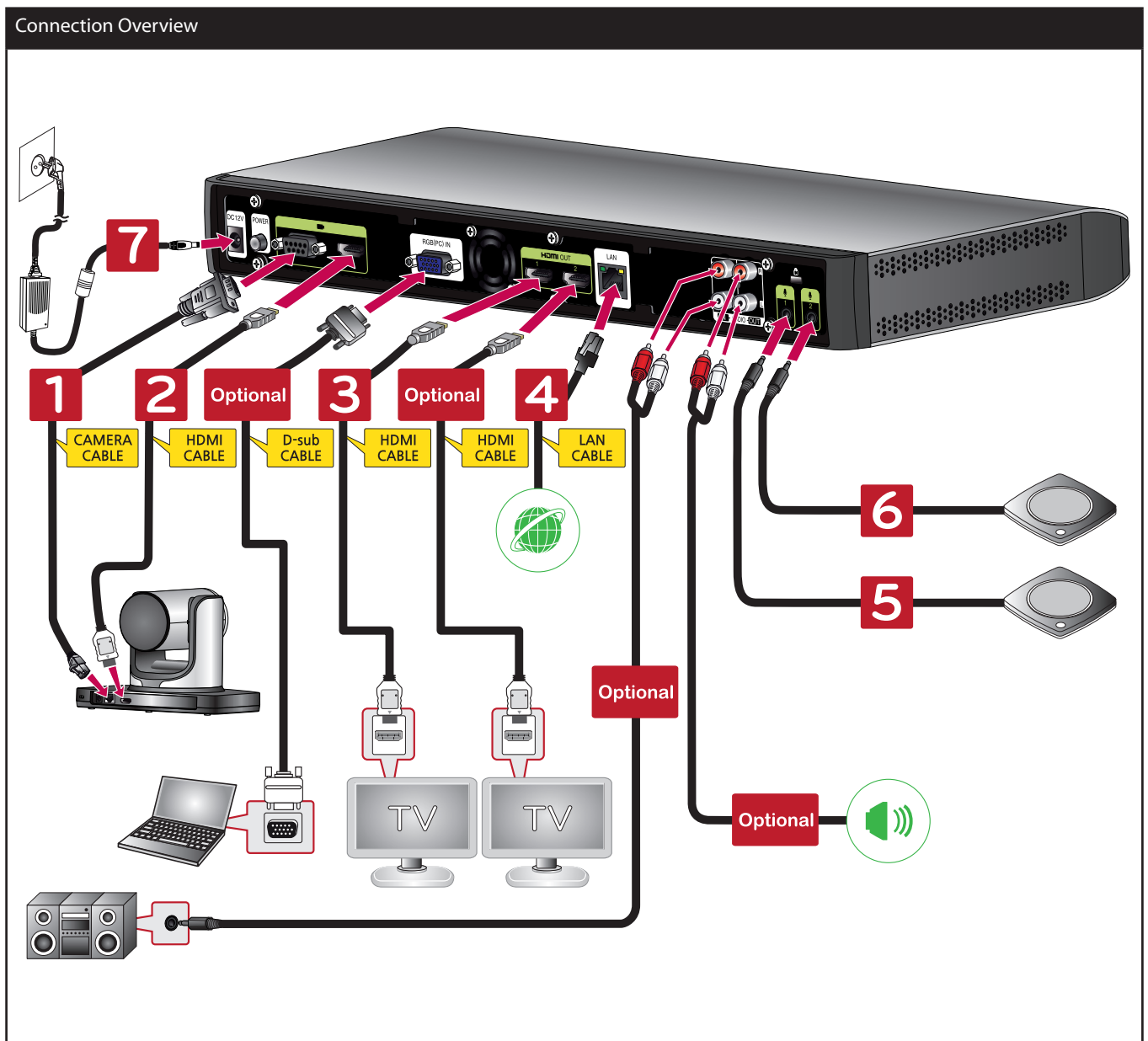

HDMI Connection

Transmit the digital video and audio signals from the system to your monitor with the HDMI cable as shown in the following illustrations.

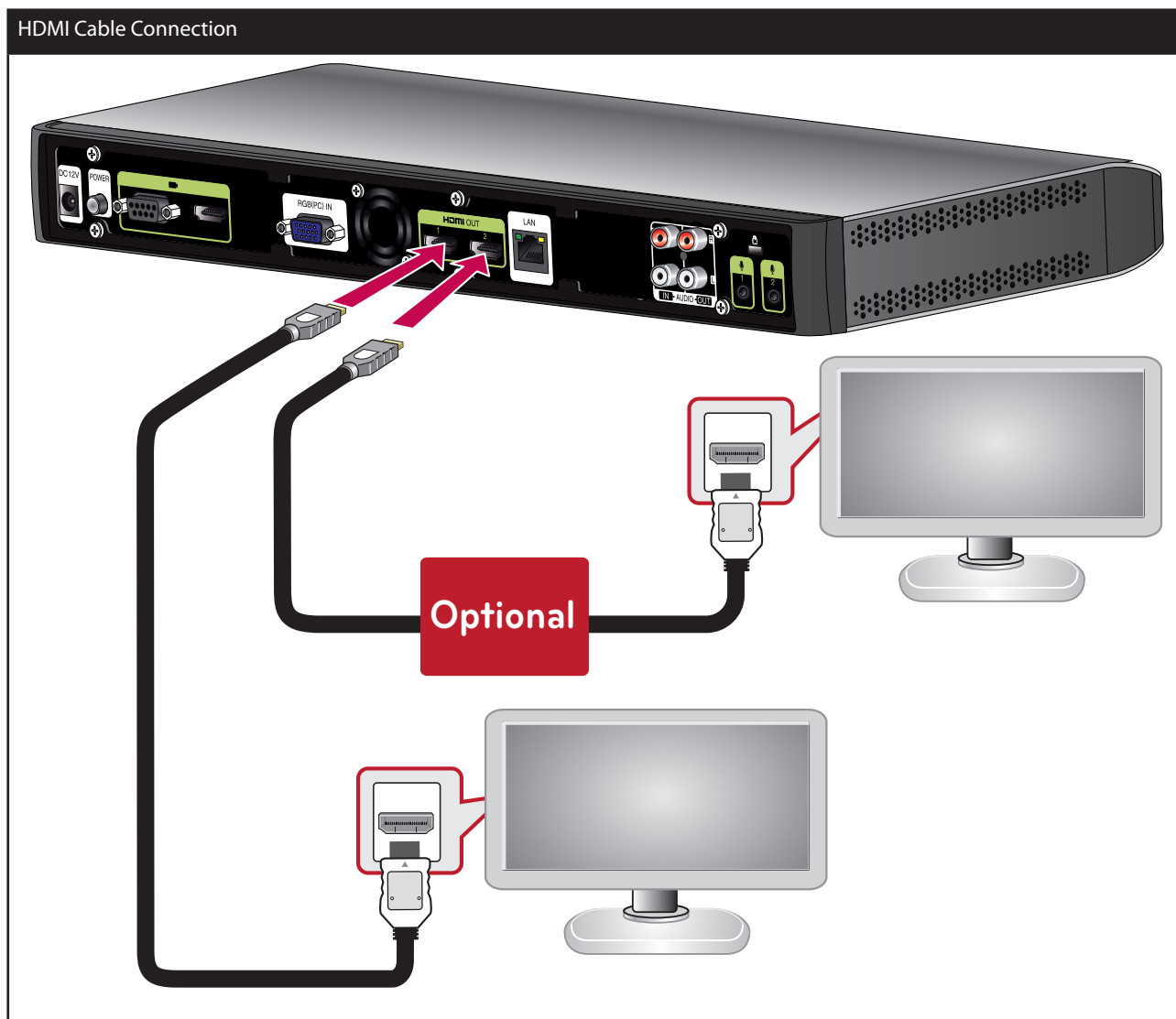

! NOTE

- It is recommended to use the monitor with built-in speaker and 1280X720 mode for the best image quality.
- If you connect the codec unit to the DVI port of monitor (TV) using HDMI to DVI converter, you should hear the audio through Audio out device because DVI does not support audio interface. Please go to [Setup > Admin > System > Audio > Audio Out] and change [Audio Out] to "Line Out".
- The HDMI OUT 2 port is used to output the contents. If you connect the HDMI OUT 2 port and use it, please go to [Setup > User > General > Second Display] and set to On.
- Do not connect Camera Input HDMI Cable to HDMI TV or monitor.

HD Camera Connection

Connects the HD camera to the camera jack of the codec unit with the supplied camera connection cable(RJ-45[with power] to D-sub Cable) as shown in the following illustrations.

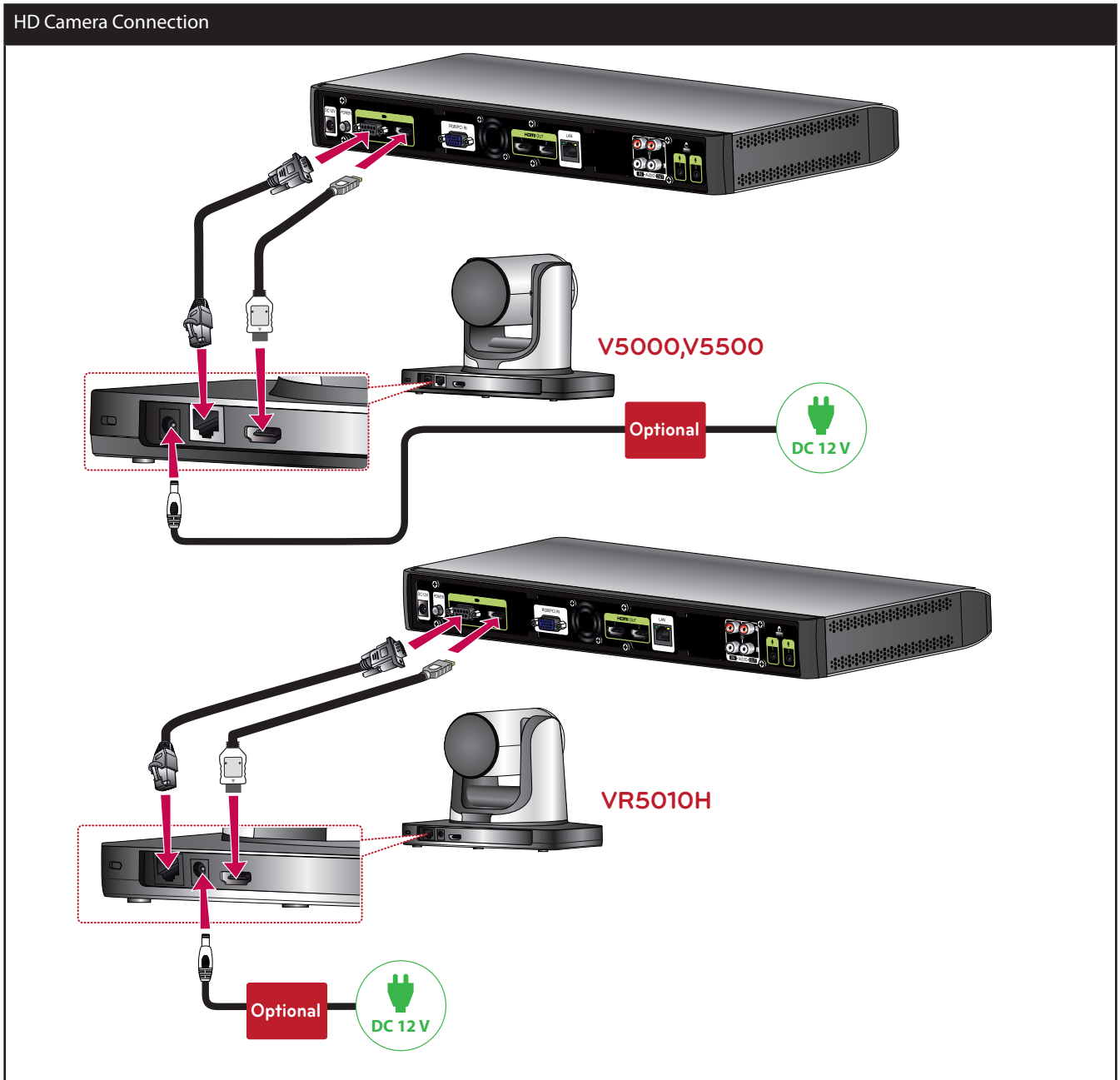

NOTE

- After connection is completed, adjust the angle of the camera to suit your view.
- Do not Connect HDMI Out Cable to Camera HDMI Input Port.
- It is recommended to use the camera with the 1280 x 720p60 mode.
- Do not connect Camera Connection Cable (RJ-45[with power] to D-Sub Cable) to other device's LAN Jack. (e.g. Note book LAN Jack)
- After connecting the Camera Connection Cable properly, turn on the Codec Box. Otherwise the VCS may cause malfunction.
- Do not hold the camera forced for a long time. Install the camera in a place with sufficient not to interrupt the rotation. This may cause product to breakdown or power may turn OFF automatically.

PC Connection

Transmits an analog video signal from your PC to codec unit. Connect the PC and the codec unit with the optional D-sub 15-pin signal cable as shown in the following illustrations. You can give a presentation to the far-end user with this connection.



NOTE

- The D-sub Cable (D-Sub 15 pin female to D-sub 15 pin) is not included. So purchase the cables separately.
- This unit supports 640 x 480, 800 x 600, 1 024 x 768, 1 280 x 720, 1 280 x 768, 1 280 x 1 024, 1 400 x 1 050 and 1 920 x 1 080 and 60Hz for PC output resolutions.
- If the PC screen can not see properly after D-sub cable insert or remove from the VCS, check the PC video output connection again .

Connecting to a Network

Connects the codec unit's LAN port to a corresponding port on your router or network using an optional LAN cable with RJ-45 connector.

Network Connection



NOTE

When plugging or unplugging the LAN cable, hold the plug portion of the cable. When unplugging, you should hold the lock of the plug portion.

Connecting an Audio device

Connects an audio device to the AUDIO OUT port of the codec unit as shown in the following illustrations.

Audio Device Connection

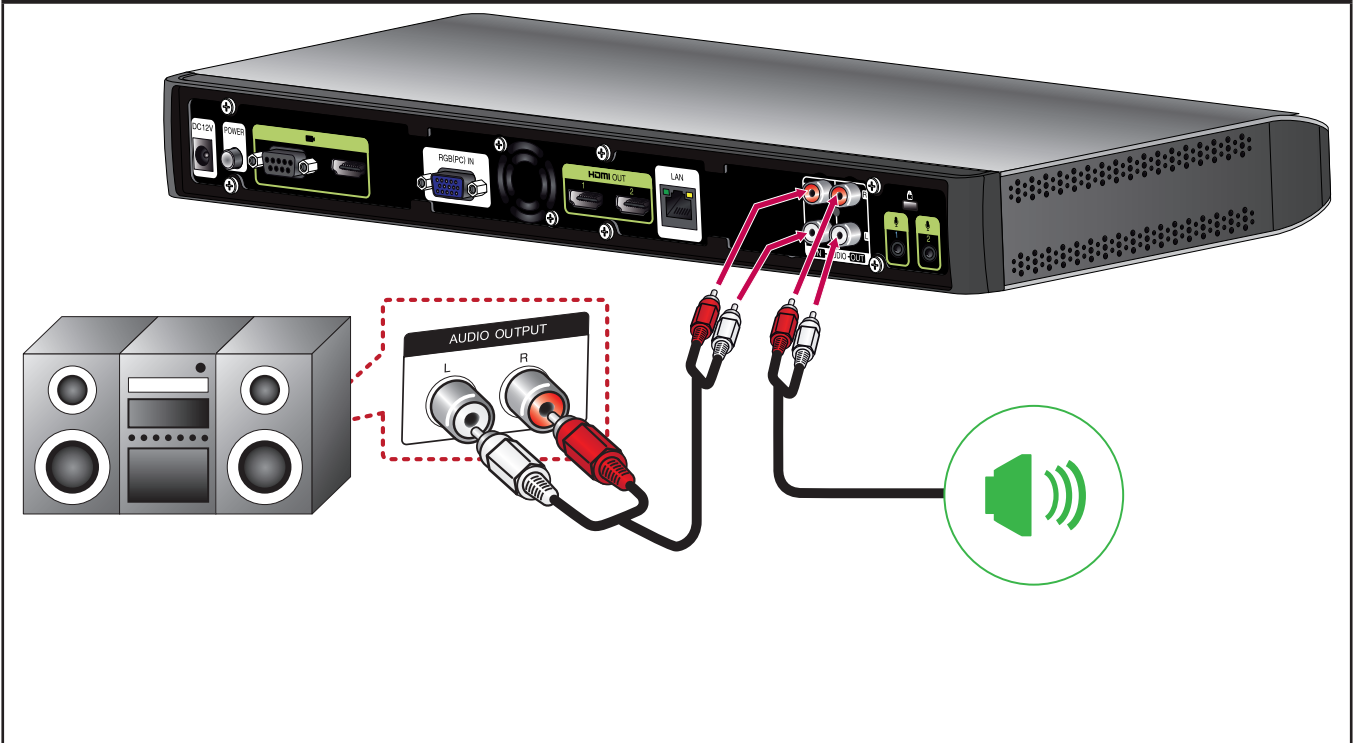

NOTE

- You can transport sound by connecting the AUDIO OUT device to the AUDIO IN Port.
- If you connect the AUDIO IN port and use it, please go to [Setup > Admin > System > Audio > Audio IN] and set to [Line IN].

Connecting a Microphone

Connects a microphone to the MIC port or AUDIO IN port of the codec unit as shown in the following illustrations.

Microphone Connection

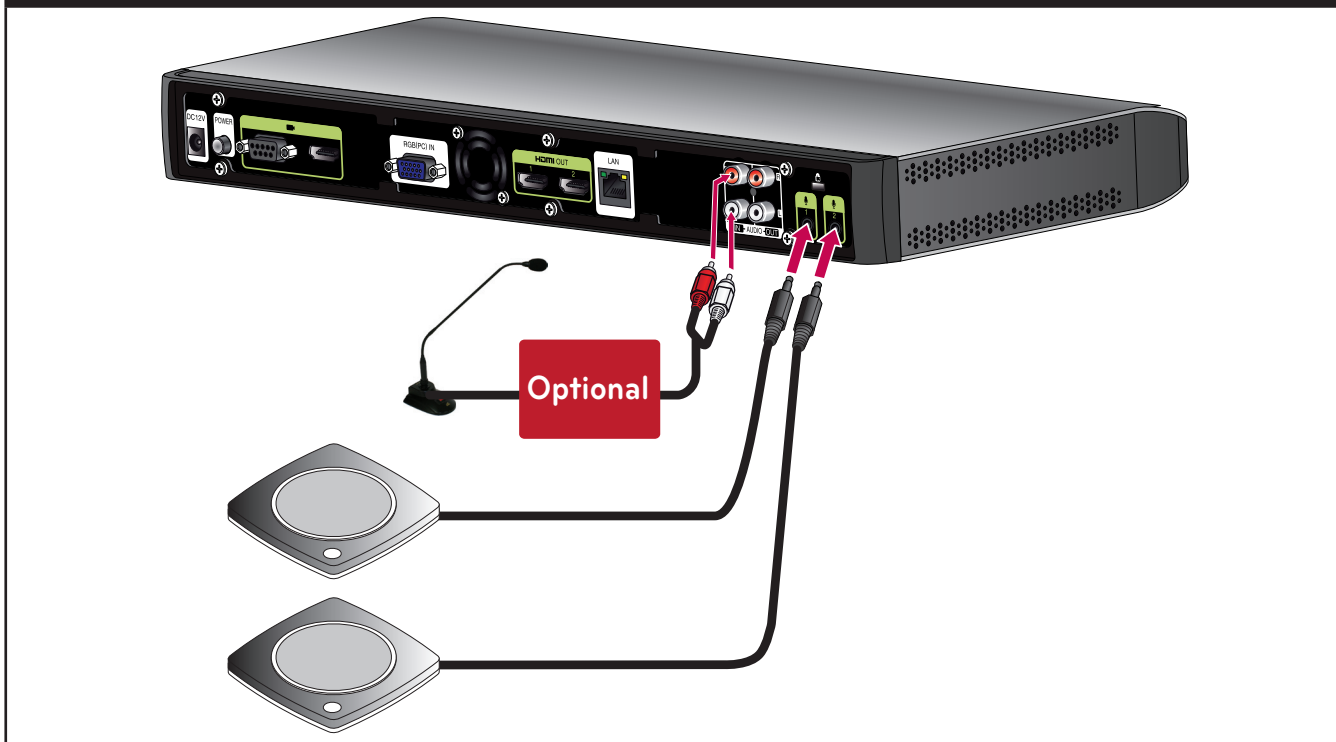

NOTE

- Refer to QSG (Quick Setup Guide) for details.
- The recommended distance between the microphone and the user is about 1 m to 2 m.
- It is recommended to use two of microphone in the auditorium.
- Place two of microphone to fill the sounds whole of conference room and leave space more than 4 m distance between each microphone.
- You can transport voice by connecting the microphone device like as Gooseneck microphone to the AUDIO IN Port.
- If you connect the AUDIO In port and use it, please go to [Setup > Admin > System > Audio > Audio In] and set to [Microphone].

Connecting Power

Connects the power cable as shown in the following illustrations.



CAUTION

You must use a supported adapter. If you connect another adapter not offered with the system, you may cause a malfunction, failure or fire.

System Connection Check

After all of the connections are completed, follow the steps below to check the system operation.

1. Turn on the monitor.
2. Press POWER on the rear of the codec unit.
System booting will commence. When the booting is completed, the initial configuration menu will be displayed.
If it is not displayed, check the device connections and make sure the connections are correctly set.
Now, you can use the system. Do the next configuration.

Using the CODEC UNIT STAND

If you use the codec unit as stand type, attach the codec unit to the codec unit stand as shown in the following illustrations.

1. Remove the stand connection cover from the codec unit.

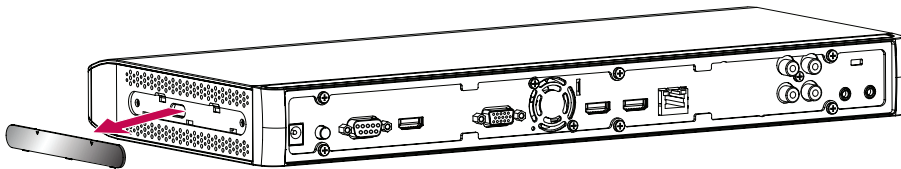

2. After aligning the position, attach the stand connection cover to bottom of the codec unit stand. Loosen the fixing screws in bottom of codec unit stand.

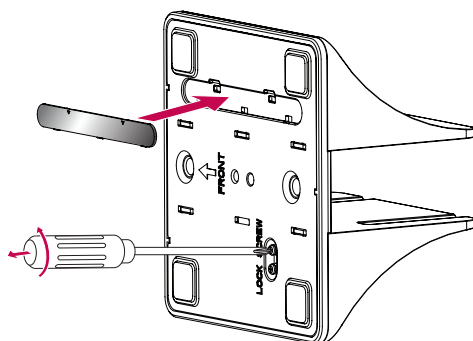

3. After aligning the position, connect the codec unit to the codec unit stand.

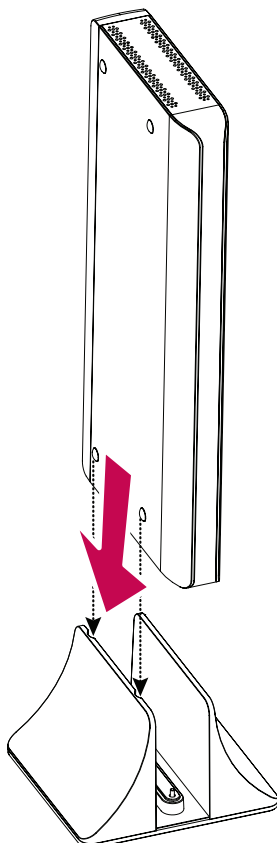

4. Tighten the fixing screws in bottom of codec unit stand.

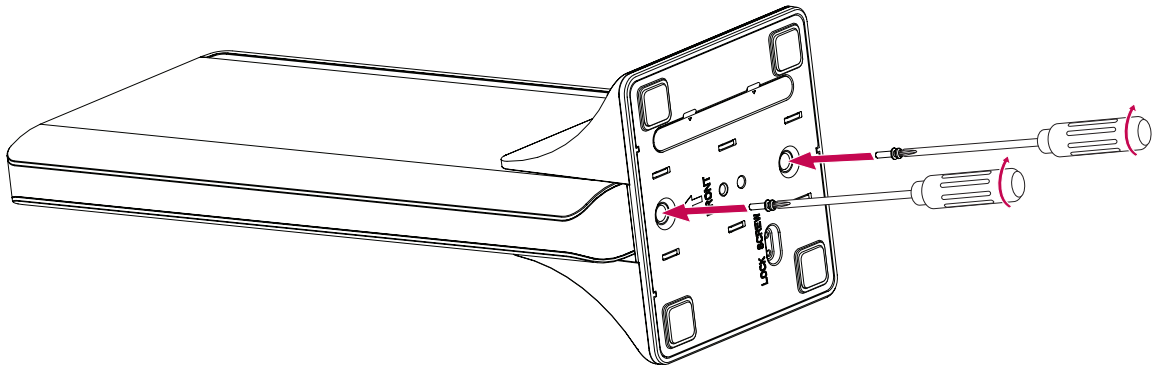

Initial Settings

When you access the VCS for the first time, the initial setting screen appears. Select a language and customize the basic settings.

1. Insert two AAA batteries matching ⊕ and ⊖ correctly into the remote controller.
2. Turn on the unit. System booting will commence. The logo image will be displayed during the system booting.
3. When the booting is complete the initial configuration menu will be displayed.
4. Select the language for the text displayed on the screen.

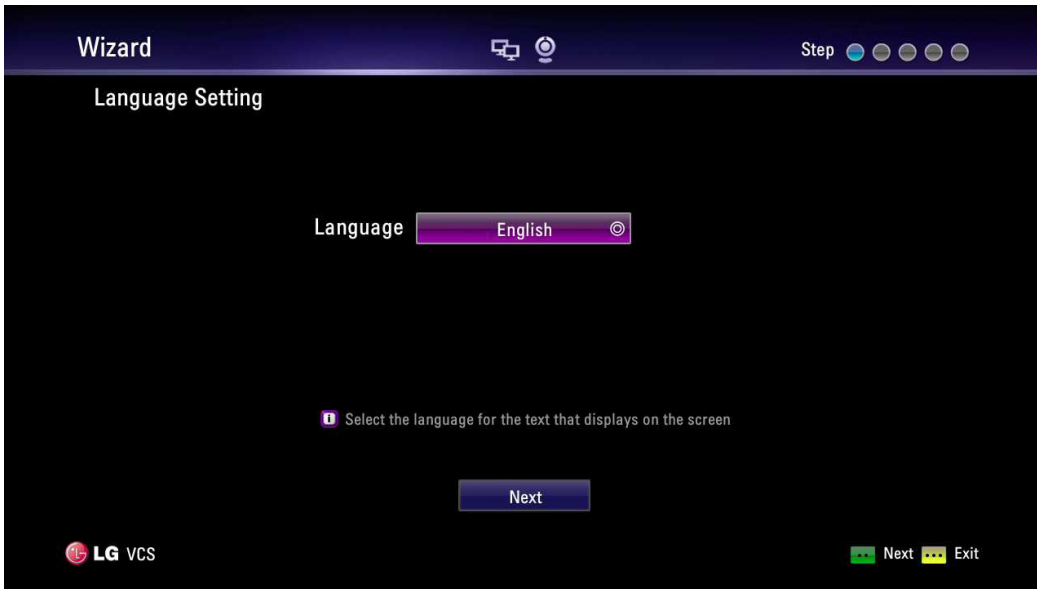

- 4-1. Select the Language option and press **OK** or [>]. The language list is displayed.
- 4-2. Select the language using [^] or [v] and press **OK**.
- 4-3. Select [Next] and press **OK** to go to the next step or press .
5. Select the wizard option.

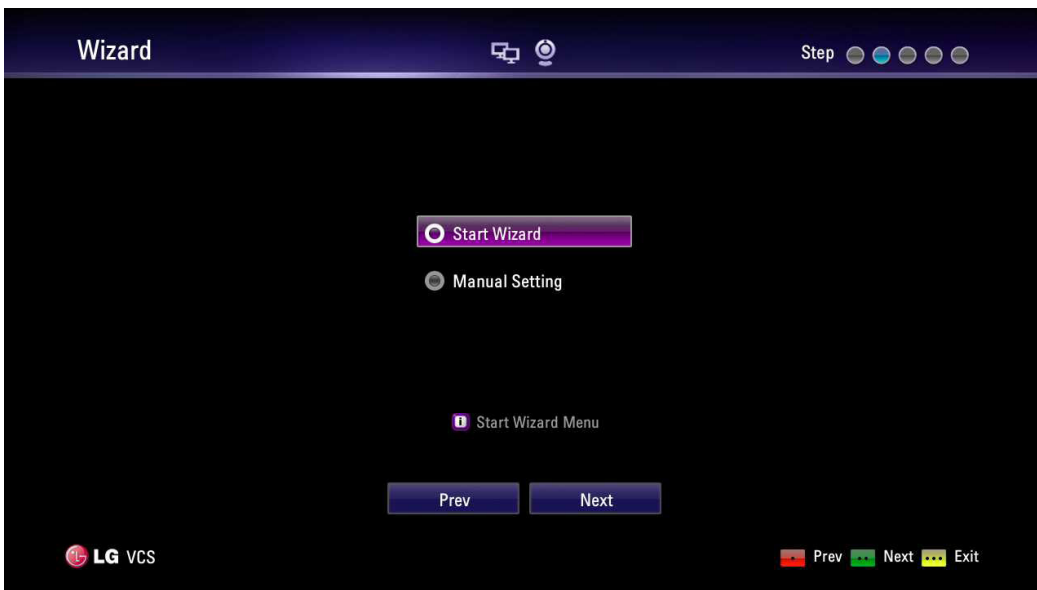

- 5-1. Select one of the below options.
 - Start Wizard: Select this option when you want to set the configuration with wizard. If you select this option, follow next steps.

NOTE
It is recommended that you use the Start Wizard option rather than the Manual Setting option.

- Manual Setting: Skip the wizard configuration and display the main setup window. You can set the system configuration manually.

NOTE
If you setup incorrectly in Manual Setting, you may not be able to connect to calls.

- 5-2. Select [Next] and press **OK** to go to the next step or press .

- 6. Select the time zone.



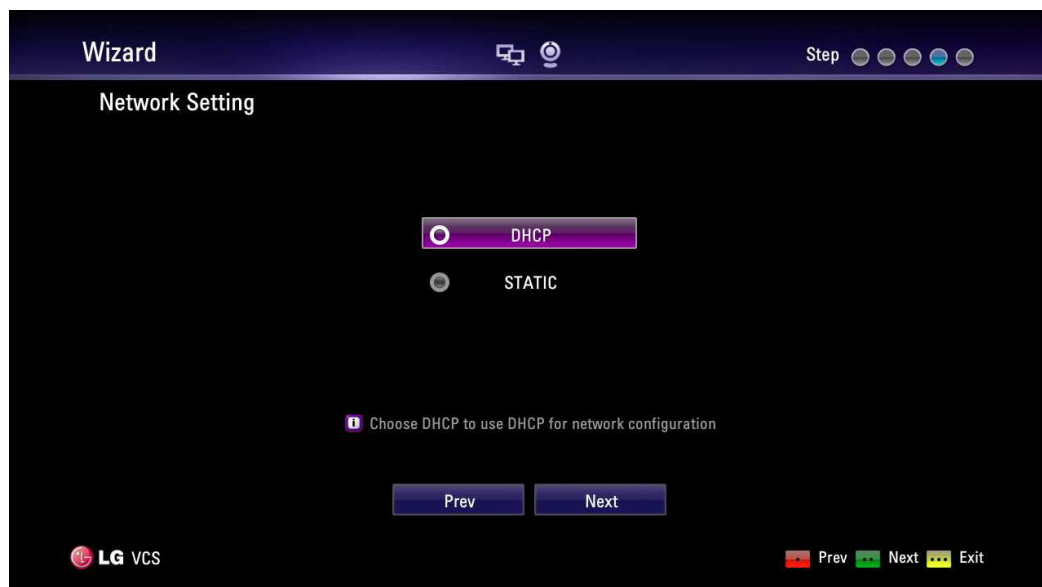

- 6-1. Use [<] or [>] to select the time zone and press **OK**.
- 6-2. Use [<] or [>] to select the country where the device is located and press **OK**.
- 6-3. Select [Next] and press **OK** to go to the next step or press .

- 7. Select the one of the network setting options.



- DHCP: Select this option when a DHCP server is installed on the network to allow IP address assignment. With this setting, the IP address is assigned automatically.
 - 7-1. Select this option and press . The IP address information window is displayed.

- 7-2. Select [Next] and press **OK** to go to the next step or press .
- Static: Select this option when you set the network configuration manually.
 - 7-1. Select this option and press .
 - 7-2. Set the below options.
 - IP Address: Enter the static IP address of the device.
 - Subnet Mask: Enter the subnet mask IP address.
 - Gateway: Enter the gateway IP address.
 - DNS Server: Enter the IP address to configure DNS servers.
 - 7-3. Select [Next] and press **OK** to go to the next step or press .
- 8. Enter a descriptive name for the system.

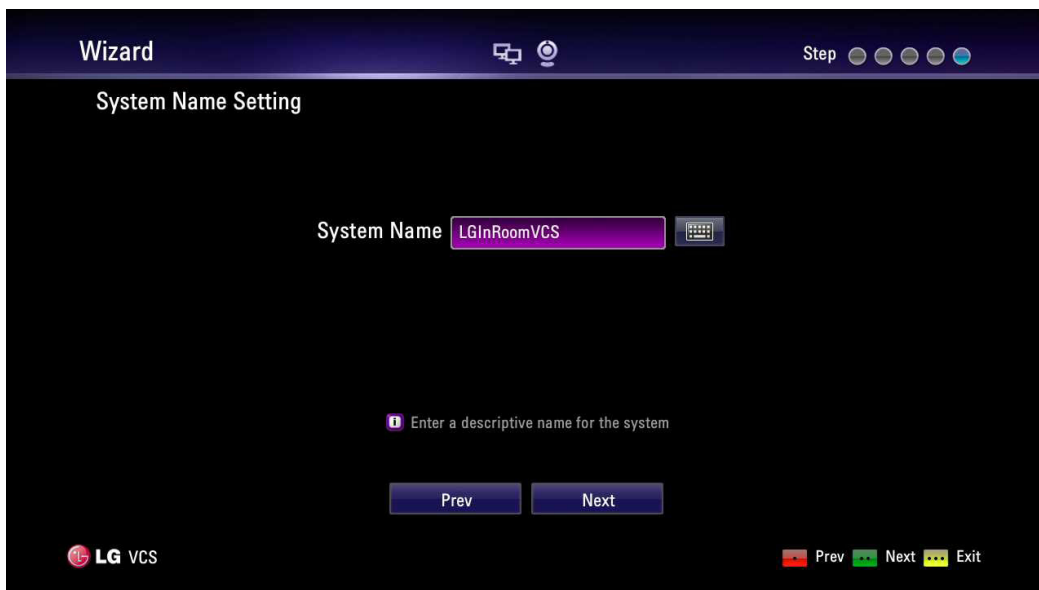

When using the remote control

- 8-1. Press **OK** to edit the system name.
- 8-2. Enter the system name using the Remote control buttons and press **OK** to confirm it.
 - DEL.: Deletes the previous character at the cursor position.
 - SPACE: Inserts space at the cursor position.
 - 1/a/A: Changes the input type to numbers, small letters or capital letters.
 - Numbers/[-*#]: Select the numbers, small letters or capital letters as selected input type. Press the button repeatedly to select the character or symbol as you want.

When using the virtual keyboard.

- 8-1. Select the virtual keyboard icon and press **OK**. The virtual keyboard input menu displayed.
- 8-2. Use the arrow buttons to select a letter and **OK** to confirm your selection.
 - <<: Moves cursor to left.
 - >>: Moves cursor to right.
 - Clear: Deletes the previous character at the cursor position.
 - Clear All: Clear all the entered characters, numbers and symbols.
 - Space: Inserts space at the cursor position.
 - a/A/?!: Changes the virtual keyboard settings to small letters, capital letters or symbols.
 - OK: Confirms and exit the menu.
 - Cancel: Returns to the previous screen.
- 9. The Wizard finish message is displayed, press **OK** to start VCS. The VCS main screen will be displayed.

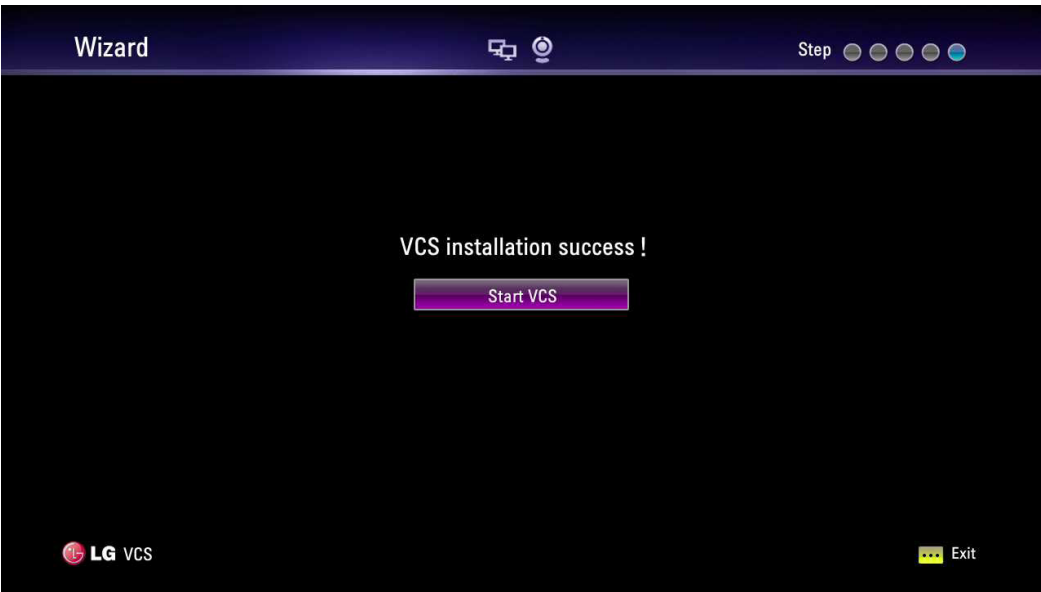







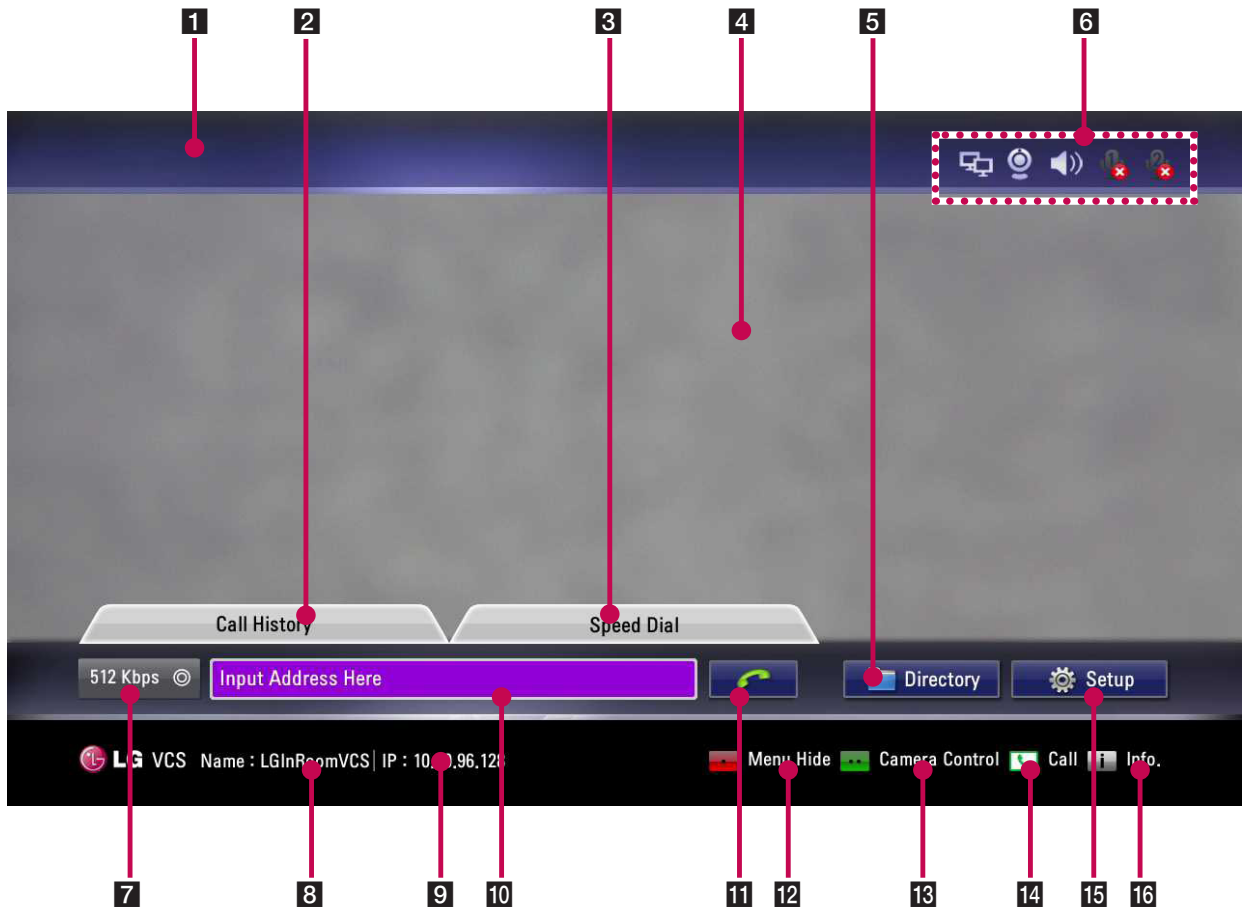

NOTE

- Additionally, refer to the on-screen instructions for each option's setting.
- If you want to move to the previous option settings, select [Prev] and press **OK** or press .

Main Screen Overview



- 1** Current Date and Time: Displays the current date and time.
- 2** Call History: You can make a call by selecting a number from a list of recently dialed numbers.
- 3** Speed Dial: You can see a list of recently saved speed dial number. You can make a call by pressing a number button of remote controller and selecting a number from list.
- 4** Local Video Area: Displays the current input video of the local camera.
- 5** Directory: Enter the directory tab to see your My Contact.
- 6** Status Icons

Activated	Disconnected	Description
		Displays the network status
		Displays the Microphone status
		Displays the camera status.
		Displays the speaker status.
-		Displays the network server status.

- 7** Call Speed: You can select the call speed.
- 8** System Name: Displays the current system name.
- 9** IP Address: Displays the current IP address of the unit.
- 10** Text Input Field: Enter the dial numbers or IP address manually.
- 11** Call Button: Use this button when you want to make a call.
- 12** Menu Hide: You can hide the user interface elements and you can show the user interface element other remote key.
- 13** Camera Control: You can select the appropriate view area.
- 14** Call: You can make a call from text input field address.
- 15** Setup: You can enter setup menu so you can change system status.
- 16** System Info: You can display system status, Audio, Video, Network Utility and Server Status.

System Configuration Menu

The features and options of the VCS are configured through the setup menu.

1. On the main screen, press **Setup** to access the Setup Menu.
Use the below buttons on the remote control to navigate the menu options.
 - Arrow buttons: Use these buttons to select the menu options or adjust the options value.
 - OK: Select the option or confirm the setting.
 - BACK: Return to the idle status.
2. Press **Setup** to exit the setup menu.

User Settings

General

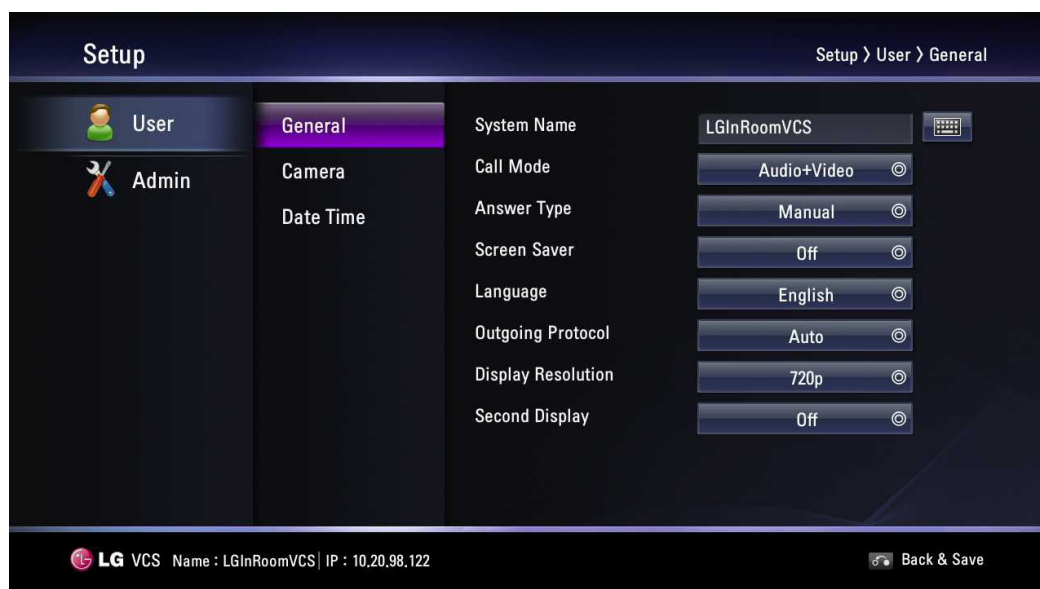

- System Name: Enter a system name using up to 127 characters. The inputted system name is displayed on the main screen.
 1. Press **OK**.
 2. Edit the system name using the virtual keyboard or remote control.
 3. Press **OK** to confirm the setting.

NOTE

If you connect a SIP call, you have to enter alphanumeric.
If you enter other characters except letters, numbers, ":", "-", and "_", you cannot connect a SIP call.

- Call Mode: Select a call mode.
 - Audio+Video: When you make a call with audio and video.
 - Audio Only: Select this option when you want to call with audio only.
- Answer Type: Select the answer type for the incoming call.
 - Auto answer : The system automatically answers the incoming call.
 - Manual: You must manually answer incoming calls.
 - Do not disturb me : When the system Do Not Disturb feature is enabled, the system displays the main screen. Callers hear a busy signal and missed calls appear in the Call History. Consider using this feature, for example, if you are using the meeting room for a purpose other than a video conference and do not wish to be disturbed by incoming calls.
- Screen Saver: When your system is idle during the selected time, it will be activated and the LG logo will be displayed on the monitor. An incoming call or pressing any button on the remote control automatically invokes the system.
- Language: Select a language for the setup menu and information display.
- Outgoing Protocol: Select the protocol to use when attempting to outgoing Call. You can choose H.323, SIP, or Auto. If you select H.323 or SIP, you can make a call selected value. If the far site user does not enable the same protocol, you can't connect to the far site. If you selected Auto, you are able to connect moderately with the far site setting. (H.323 is tried before the SIP. If H.323 does not connect, a SIP call is attempted automatically.)
- Display Resolution: Select the display resolution of the connected monitor. If you change the resolution, the confirmation window is displayed and then press **OK** to reboot the system. You can set the system to 720p, 480p. The default is 720p.
- Second Display: Set to ON when you use the second display for content viewer. If you use the content sharing function, the content will be displayed from the second display device of the connected with the HDMI OUT 2 port.

Camera



- White balance Mode: Select the Whitebalance activation mode. Adjust the white balance when video color appears to be unbalanced. White balance is affected by the type of light source.
 - Auto: The whitebalance function is activated automatically.
 - ATW: The color temperature range for the proper white balance is approximately 1 700 K to 11 000 K.
 - Manual: Adjust the white balance level on the Whitebalance level menu.
- White Balance Level: Set the white balance level. This option is activated when set manual in the [White Balance Mode] menu.
 1. Press **OK** and adjust white balance using the left or right arrow button.
 2. Press **OK** to confirm the setting.
- Color: Select the Color level for the camera. You can improve or suppress the color level by manually adjusting the camera color reproduction.
 1. Press **OK** and adjust color level using the left or right arrow button.
 2. Press **OK** to confirm the setting.
- Brightness: Select the brightness level for the camera. Camera brightness refers to the received amount of light through the lens of the camera. You can improve dim scenes by manually adjusting the camera brightness.
 1. Press **OK** and adjust brightness using the left or right arrow button.
 2. Press **OK** to confirm the setting.
- Sharpness: Select the sharpness level for the camera.
 1. Press **OK** and adjust sharpness using the left or right arrow button.
 2. Press **OK** to confirm the setting.
- Focus Mode: Select the camera focus mode.
 - Trigger Auto: The focus function is activated when using the PTZ function manually.
 - Auto: The focus function is activated automatically.
- Shutter: Lights powered by a 50 Hz power source can produce a flicker that the camera captures and transmits to the system. If you are using lights powered by a 50 Hz power source and observe a flicker in the video displayed in your system, select the Anti-Flicker (60 Hz) option. The default option is Auto.
- Backlight:
 - On: Select when you want to activate the Backlight function. If you set to On, the WDR option is disabled.
 - Off: Not used.
- WDR: WDR (Wide dynamic Range) feature can be very helpful to cope with very challenging lighting conditions. It is capable of capturing both of the dark part and bright part and combining the differences into a scene to generate a highly realistic image as original scene.
 - On: Select when you want to activate the WDR function. If you set to On, the Shutter and Backlight options are disabled.
 - Off: Not used.

Date Time

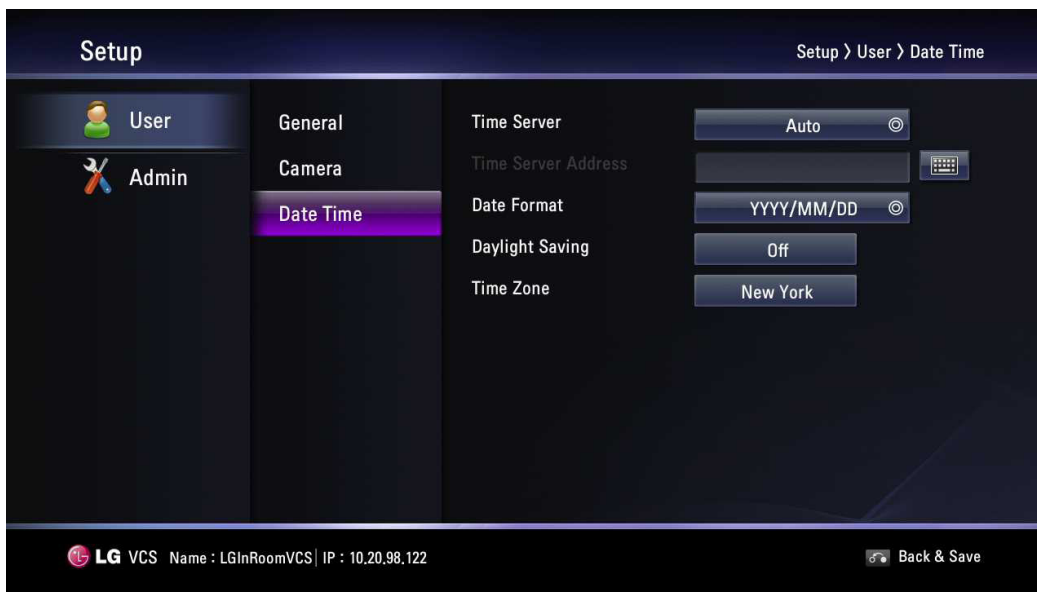

- Time Server: Select time setting method.
 - Auto: Set the time server automatically.
 - Manual: Set the time server manually. Usable NTP servers are shown below.

NTP Server	IP address
time.nist.gov	192.43.244.18
time-a.nist.gov	129.6.15.28
time-b.nist.gov	129.6.15.29
ntp.nasa.gov	198.123.30.132
clock.isc.org	204.152.184.72
time.bora.net	203.248.240.140

- Time Server Address: Enter the IP address or hostname of the time server. This option is activated when you set to manual in the [Time Server] setting menu.
- Date Format: Select the display format for date.
- Daylight Saving: Set the daylight-savings time.
 1. Press **OK** and then the daylight-savings time setting menu will be displayed.
 2. Mark up to set the daylight-savings function.
 3. Set the daylight-savings start time.
 4. Set the daylight-savings end time.
 5. Press **OK** to confirm the setting. After setting, the daylight-savings option is set to On.
- Time Zone: Select the time zone for your system.

Admin Settings

If you select this, the password input window is displayed.

To change the administrator settings, you should input the password. The default administrator password is "1234". Enter the password to display the administrator sub-menu options.

Call Settings

General



- Maximum Call Time: Enter the Maximum Call Time from 0 minute to 99999 minutes. After the entered minutes, the pop-up will be displayed. So, you can hang up or continue the call.
- Maximum Bandwidth: Select the maximum amount of network bandwidth to use for video call.

H.323

This unit supports the H.323 protocol for placing and receiving video and voice calls. This is used when a gatekeeper function is attempted.



- H.323 Name: Enter the name of the device used when making calls with H.323 with the alphabet, numbers and special characters.
- E.164 Name: Enter the name of the device used when making calls with numbers. This name is used when users register in the gatekeeper server. If the device is registered on gatekeeper server, the far site user can call this name.

- Security: H.235 128-bit AES security in H.323 calls. When enabled, the system automatically encrypts calls to other systems that have AES encryption enabled. When set to AES, calls connect, are encrypted only if the far end supports AES encryption. If the far end user does not support AES encryption, calls are not encrypted.
- Use Gatekeeper: Set to On when you use the gatekeeper function. This unit supports the H.460 protocol for firewall and NAT traversal of H.323 calls. You must have an H.460 server configured in your environment for this feature to function properly. If you set to On, the H.460 NAT, Gatekeeper Address and Gatekeeper Port options are enabled to set it.
- H.460 NAT: Set to On when you use the H.460 standard for NAT and firewall traversal.
- GateKeeper Address: Enter the IP address of the primary H.323 gatekeeper.
- GateKeeper Port: Enter the port number of the primary H.323 gatekeeper.

NOTE

- You can check the registered status in the Server Status menu of the system information window.
- Security function may not be supported in specific countries.
- When both Near End user and Far End user are set the AES encryption to enable before call connection  is displayed during a call on the call screen.
- Web monitoring is not supported while AES encryption is activated during a call.

SIP

This part is used when users attempt to use a SIP server.

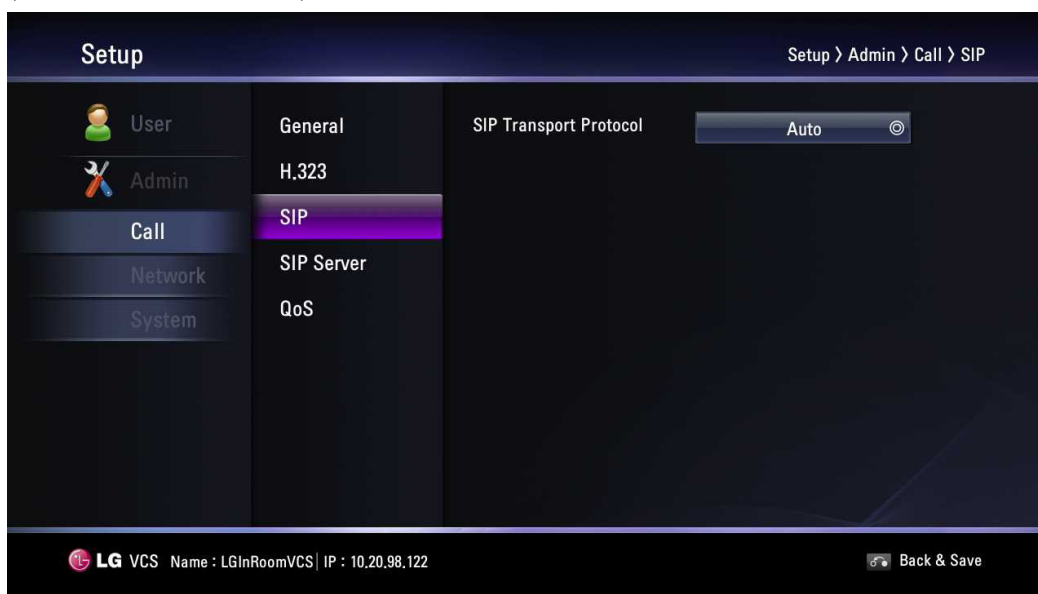

- SIP Transport Protocol: Select the transport protocol to use during sip outgoing call. You can choose AUTO, UDP or TCP. If you select TCP or UDP, you can make a SIP call with the selected value. If the far site user does not enable the same transport protocol, you can't connect to the far site. If you select Auto, you are able to connect moderately with the far site.

SIP Server

This part is used when users attempt to use a SIP server.

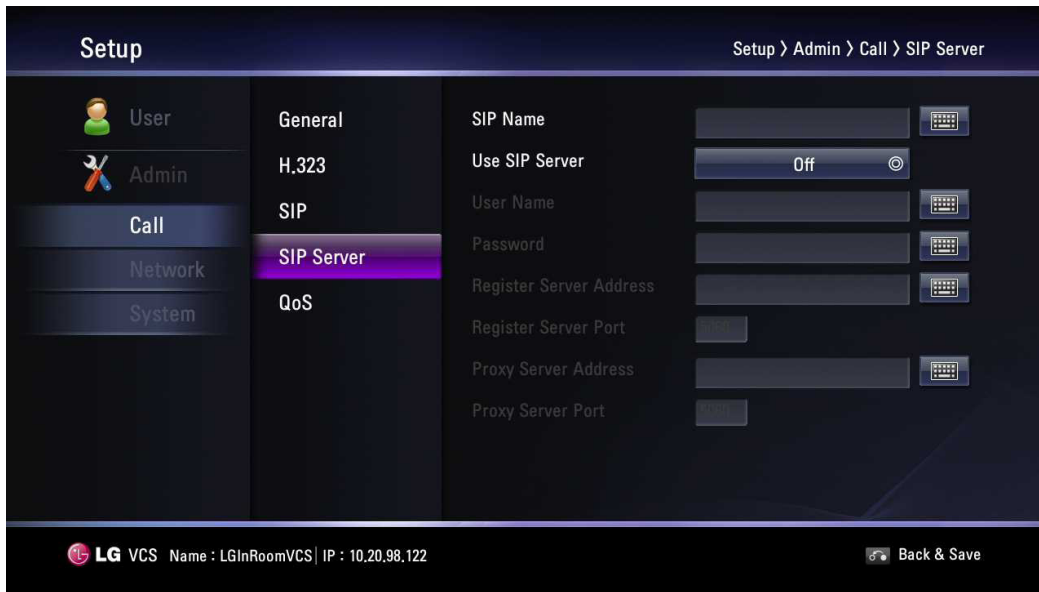

- SIP Name: Enter the name of the device used when making calls with SIP. The SIP name can be used with alphanumeric. If you enter other characters except letters, numbers, ",", "-", and "_", you cannot connect a SIP call.
- Use SIP Server: Set to On when you use the SIP server. If you set to On, the username, password, register server address, register server port, proxy server address and proxy server port options are enabled to set it.
- User Name: Enter the SIP server authorization username.
- Password: Enter the SIP server authorization password.
- Register Server Address: Enter the hostname or IP address of the SIP register server.
- Register Server Port: Enter the IP port number of the SIP register server.
- Proxy Server Address: Enter the hostname or IP address of the SIP proxy server.
- Proxy server Port: Enter the IP port number of the SIP proxy server.

QoS

You can specify network Quality of Service (QoS) settings.

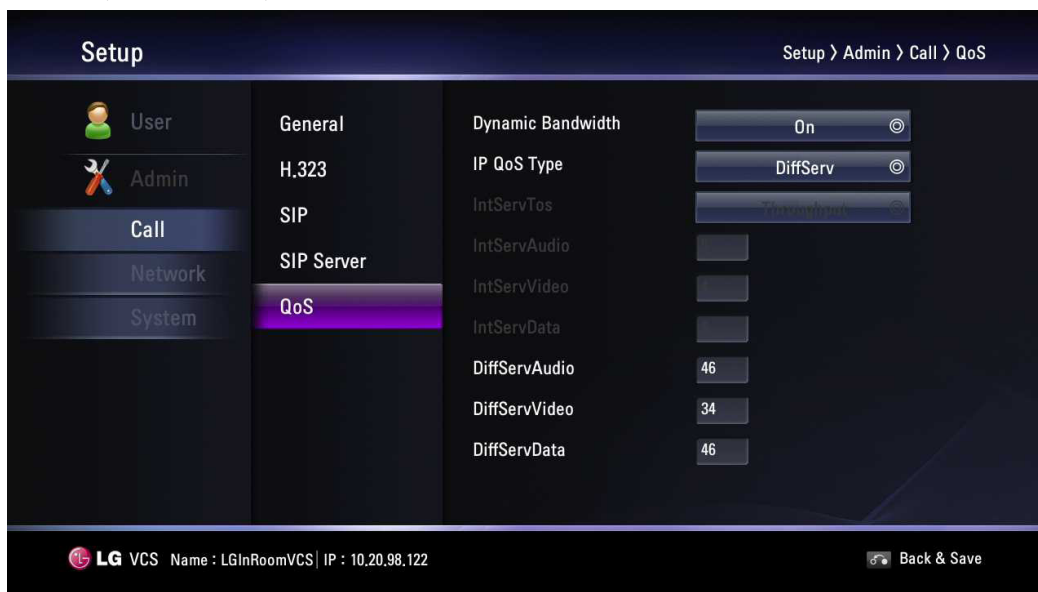

- Dynamic Bandwidth: Adjusts the bandwidth automatically for the best video bandwidth available.
 - On: Dynamic bandwidth function is used.
 - Off: Not used.
- IP QoS Type: Select the type of TCP/IP Quality of Service (QoS) that your network uses.
 - None: Not used.
 - DiffServ: Set to DiffServ (differentiated services) type of Service (QoS) for audio, video and data packets.
 - IntServ: Set to IntServ (integrated services) type of Service (QoS) for audio, video and data packets of the Service (ToS) preference. If you select this option, the IntServToS option is enabled to set it.
- IntServToS: Select IP Type of Services. This helps a router select a router path when multiple paths are available.
- IntServAudio: Enter the priority of Audio for Intserv Quality of Service (QoS). [Range 0~7]
- IntServVideo: Enter the priority of Video for Intserv Quality of Service (QoS). [Range 0~7]
- IntServData: Enter the priority of Data for Intserv Quality of Service (QoS). [Range 0~7]
- DiffServAudio: Enter the priority of Audio for Diffserv Quality of Service (QoS). [Range 0~63]
- DiffServVideo: Enter the priority of Video for Diffserv Quality of Service (QoS). [Range 0~63]
- DiffServData: Enter the priority of Data for Diffserv Quality of Service (QoS). [Range 0~63]

Network Settings

IP

You must set the IP address for the call.

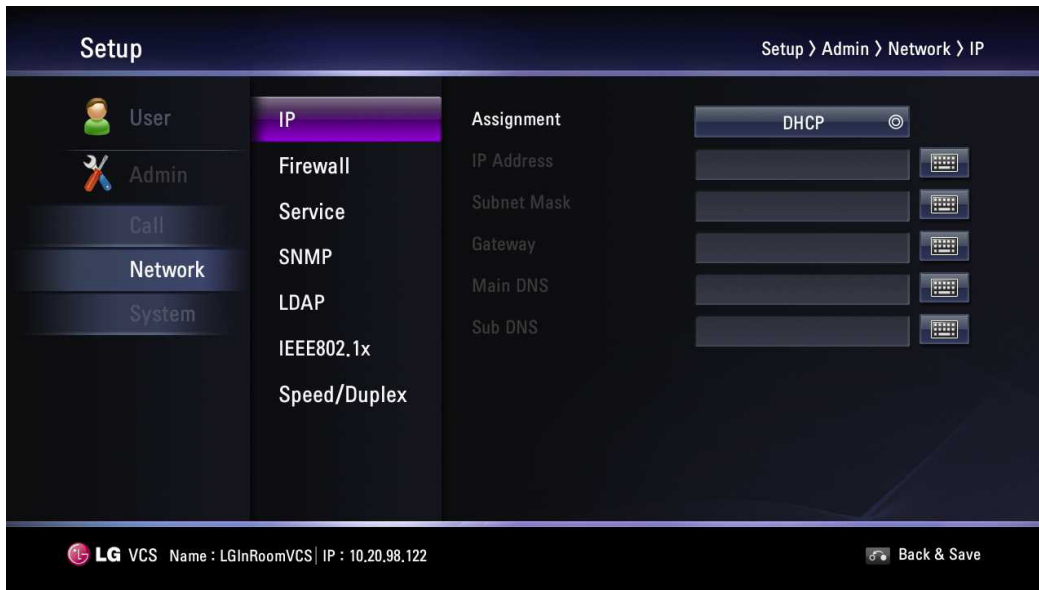

- Assignment: Set to STATIC or DHCP for your network configuration.
 - DHCP: Select this option when a DHCP server is installed on the network to allow IP address assignment. With this setting, the IP address is assigned automatically. If you set to this, the IP address, subnet mask, gateway, main DNS and sub DNS options are dimmed.
 - STATIC: Select this option when you set the network configuration manually.
- IP Address: Enter the static IP address of the device.
- Subnet Mask: Enter the subnet mask IP address.
- Gateway: Enter the default gateway IP address.
- Main DNS: Enter the Primary domain name server that translates the hostnames into IP address.
- Sub DNS: Enter the sub DNS server address that backups the main DNS.

Firewall

This function is used when users try to bypass the firewall.



- NAT Configuration:
 - Disable: Not used with this function.
 - Enable: Select when using the static NAT server to traverse your firewall. If you select this option, the NAT Public Address and Fixed Port options are enabled.
- NAT Public Address: Enter the public IP address or hostname of the system.
- Fixed Port: You can fix the TCP and UDP port range. If you set to On, the TCP port and UDP port options are enabled.
- TCP Port: Enter the lowest/highest number in the reserved range of the TCP port numbers. (Minimum range of port is 1.)
- UDP Port: Enter the lowest/highest number in the reserved range of the UDP port numbers. (Minimum range of port is infinite.)

Service



- Web Server: If you set to On, you can connect to this device using the web browser.
- Telnet: If you set to On, you can connect to this device using the telnet.
- SSH: If you set to On, you can connect to this device using the SSH.

SNMP



- SNMP: Allows administrators to manage the system remotely using SNMP.
 - Disable: Not used with this function.
 - Enable: Selects when SNMP is allowed access to this device. If you select this option, the Trap Host and Community options are enabled.
- Trap Host 1 to 3: Specifies the IP address of the computer you intend to use as your network management station and to which SNMP traps will be sent.
- Community: Specifies the SNMP management community in which you want to enable this system (e.g. lgecommunity or public).

LDAP

LDAP is the ability to read registered address books in the LDAP server. If you connect to an LDAP server, you can confirm in corporate contact tab in directory.



- LDAP:
 - Disable: Not used with this function.
 - Enable: Selects when the LDAP server allows access to this device.
- Hostname: Enter the host name or IP address of your LDAP server.
- User: Enter the username of your LDAP server.
- Password: Enter the password your LDAP server.
- Base: Enter the base Distinguished Name (DN) used to query your LDAP server.
- Filter: Enter filter strings that you use to specify a subset of data items in an LDAP data type.

IEEE802.1x

Specifies whether 802.1X network access is enabled. This systems support the following authentication protocols:

- EAP-MD5
- EAP-PEAP
- EAP-TTLS

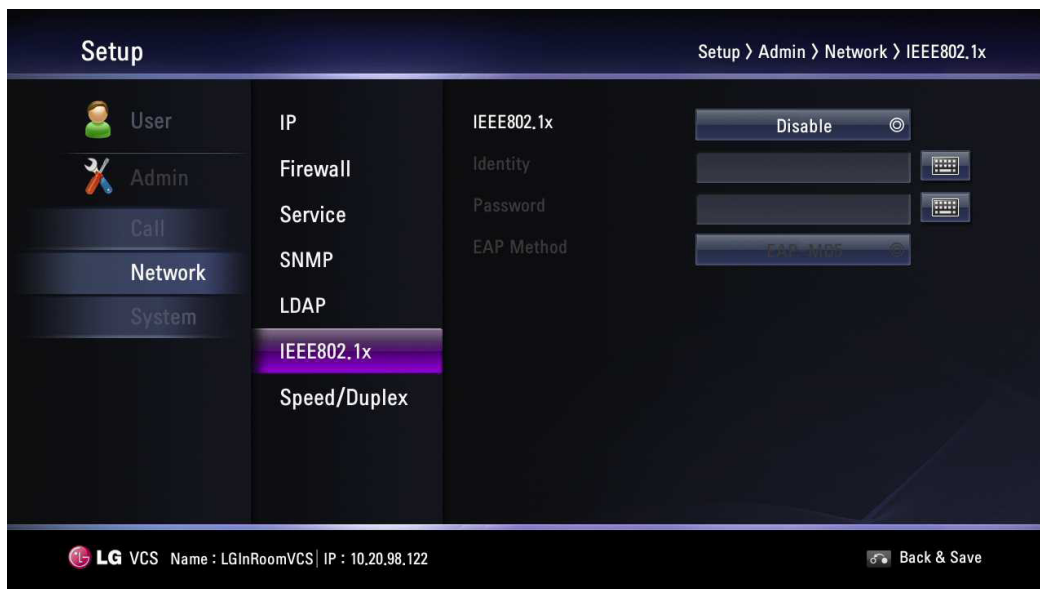

- IEEE802.1x:
 - Disable: Not used with this function.
 - Enable: Select this option to 802.1x user authentication. If you select this option, identity, password and EAP method options are enabled.
- Identity: Enter the identity name given to you by your IT administrator. This specifies the system's identity used for 802.1X authentication.
- Password: Enter the password given to you by your IT administrator. This specifies the system's password used for 802.1X authentication.
- EAP Method: Select the EAP method.

**NOTE****When User Use EAP-MD5**

If you use EAP-MD5, you do not need to upload any files in the web service.

When User Use EAP-TTLS

1. If you use EAP-TTLS, you must receive ca.pem, client.pem, client.key from the 802.1x network manager.
2. Upload the ca.pem, client.pem, client.key files to the web service of your system as shown in the picture below.

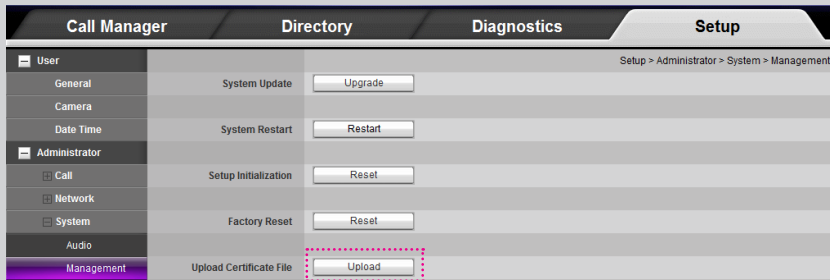
**When User Use EAP-PEAP**

1. If you use EAP-PEAP, you must receive a ca.pem file from the 802.1x network manager.
2. Upload the ca.pem file to the web service of your system as shown in the picture below.

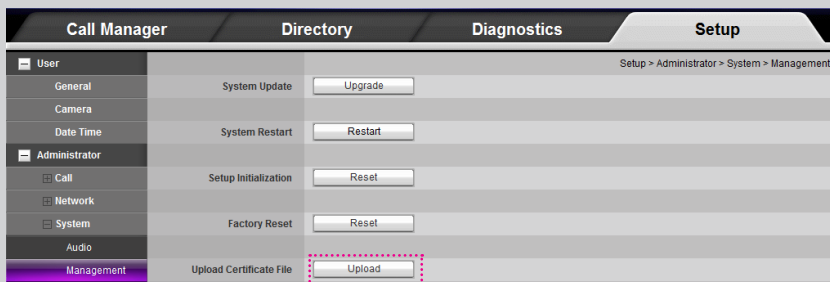
**After Setting 802.1x**

1. When you finish these settings, confirm that you can see your IP on the main screen.
2. Perform a ping test in the system info > Network utility > Command.
3. You can now attempt to call other VCS.

Speed/Duplex



- Assignment: Select the Auto or Manual mode to set the value of Speed/Duplex. When Assignment is set to Auto, the highest priority is 100 Mbps. If you set to the Manual mode, the Speed and Duplex options are enabled.
- Speed: Select the speed that your network uses.
- Duplex: Select duplex mode that your network uses.

System Settings

Audio

Adjust settings for audio input and output devices connected to the system.



- Audio In: Select the audio input to use for the active microphone.
 - Microphone: Audio is input via the connected microphone.
 - Line in: Audio is input via the connected Audio device.
- Echo Control: Select echo function to ON or OFF.
 - On: Select when you want to turn on the echo cancellation.
 - Off: Select when you want to turn off the echo cancellation.
- Audio Out: Select the location for audio output during calls.
 - HDMI: Audio is output via the connected HDMI device.
 - Line Out: Audio is output via the connected audio device.
- RingTone: Select the volume level of the ring tones.
 - Off: The ring tone volume is off.
 - Small: The ring tone volume is set to small.
 - Middle: The ring tone volume is set to middle.
 - Loud: The ring tone volume is set to loud.

Management



- Admin Password: Change the password of the administrator if you want. The password is case-sensitive.
- System Restart: To restart the system, do the below steps.
 1. Select Restart and press **OK**. The warning window is displayed.
 2. Select [OK] and press **OK**. The system will be restarted.
- Setup Initialization: You can initialize the configuration of the setup menu.
 1. Select Reset and press **OK**. The warning window is displayed.
 2. Select [OK] and press **OK**. The system will be initialized and restarted.
- Factory Reset: You can reset the system to its original factory settings.
 1. Select Reset and press **OK**. The warning window is displayed.
 2. Select [OK] and press **OK**. The system will be reset to factory default settings and restarted.



NOTE

If you select the [Factory Reset] option, the saved address in the directory and call history will be deleted.

System Information

After the configuration setup, you can view the condition of the system.
Press **i** (INFO) to display the system information.

System Status

You can view the information of the current system status and configuration.

The screenshot shows the 'System Info' page with a sidebar on the left containing 'System Status', 'Video', 'Audio', 'Network Utility', and 'Server Status'. The 'System Status' section is active and displays the following information:

System Type	Codec Phone
System Version	Main:7950-20121107-PH8 / Camera:0a-10-0,08-0,20
System Name	LGIInRoomVCS
Model	V5500
Serial Number	
Physical Address	e8:5b:5b:b8:74:10
Network Status	connected
Network Speed	100Mb/s (full-duplex)
Network	DHCP
IP Address	10.20.98.111
Subnet Mask	255.255.254.0
Gateway	10.20.98.1
DNS Server	165.244.106.110

Video

You can check the video condition.

The screenshot shows the 'System Info' page with the 'Video' section selected in the sidebar. The main content area displays the following video-related information:

Input Video	Camera	Contents
Input Video Resolution	disconnected	disconnected
Display Type	Primary Output	
Display Resolution	720p	

Audio

You can check the audio condition.



How to Test the Audio Output

1. Select the Audio Out Test option using the arrow button.
2. Press **OK** and select the audio output option between the HDMI and Line Out option.
3. Press **OK** and select [Start].
4. Press **OK** again to test the audio output. You will hear sound, then exit the test. If you cannot hear the sound, check the volume level or connection.

Network Utility

You can troubleshoot network connection issues with your system using the ping and traceroute utilities in Network Utility.

1. Select the IP Address field.
2. Press **OK** to enter a value. If necessary, use **1/a/A** to change the method of text entry for text fields or select the keyboard icon to display the virtual keyboard. After entering a value, hide the keyboard (if you used it to enter the value) and press **OK** to exit the field.
3. Select the option of the command menu.
 - Ping: The ping command tests responsiveness between two devices.
 - Traceroute: The traceroute command tests responsiveness and traces the path of a packet from one device to the other.
4. Press Start and press **OK** to test it.

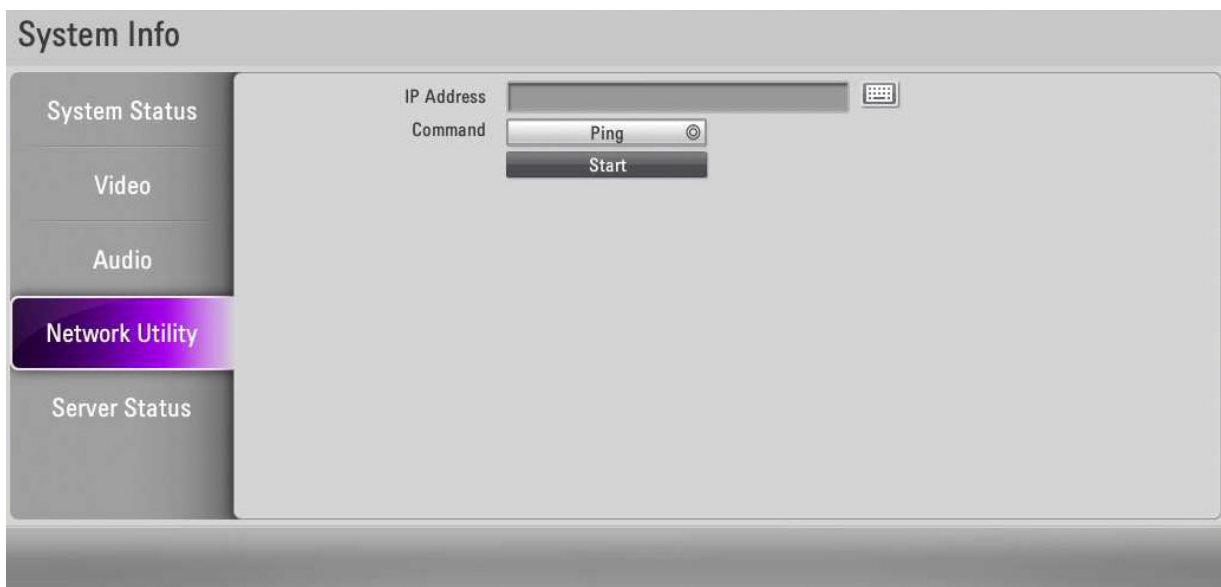

Server Status

You can view the server status.



The screenshot displays the 'System Info' interface. On the left, a vertical sidebar contains navigation buttons: 'System Status', 'Video', 'Audio', 'Network Utility', and 'Server Status'. The 'Server Status' button is highlighted with a purple gradient. The main content area shows a table of server components and their status.

Component	Status
H.323 Gatekeeper	Disable
SIP Server	Disable
LDAP	Disable
SNMP	Disable

4 Operation

Before Using the System

- Before using the LG VCS device, make sure the connections are correct and verify that a proper power supply is used.
- Check the connections of the LG VCS device for the correct conditions.
- Check that the LG VCS device is connected to the network and power is supplied.
- Before using the VCS, make sure the network settings are correct.
- Before placing a call, examine the near end video image from the connected camera to your system. If the image flickers, colors appear unbalanced or the image appears too dark, you may need to adjust the room lighting or camera brightness and white balance and check the Shutter menu.

Placing a Call

You can place a call from your system to another VCS. Begin a call in one of the following ways:

Placing a Call Manually

You can place a call by entering the IP address manually.

1. Select the Text input field and press **OK**.

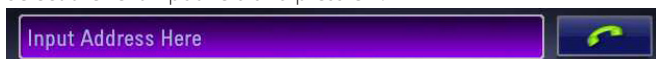

2. Enter an IP address or dial numbers.
Use [1/a/A] to change the method of text entry for text input field.

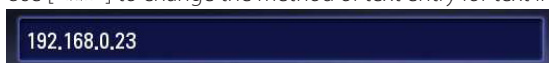

3. After entering a value, press **OK**.  is selected automatically.
4. Press **OK** again to place a call. The call status dialog box is displayed.

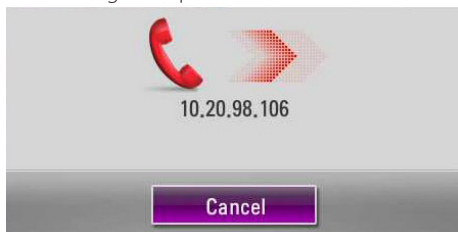

The call status dialog box shows the number or IP address that you are attempting to call and the status of the call.

NOTE

- If you cancel the call, press **OK** during the dialing.
- If the system does not answer the call within about 120 seconds, your system will be disconnected automatically.
- Check the IP address of the system before you place a call. If you do not set the IP address correctly or set the wrong IP address, you can not make a call.
- You can select call speed which is the maximum amount of network bandwidth to use for video call in the main screen.

Multipoint Call (V5500 Only)

You can add the other user during the call.

1. Press  during the call.
2. Follow steps 1-4 described in "Placing a Call Manually".

NOTE



You can add up to 3 users.

Placing a Call from the Call History

The list of the Call History stores up to 50 recently dialed phone numbers. The oldest entry in the list is automatically removed when the system receives a call or places a call after the maximum number of entries has been reached. The last call placed always appears first on the list.

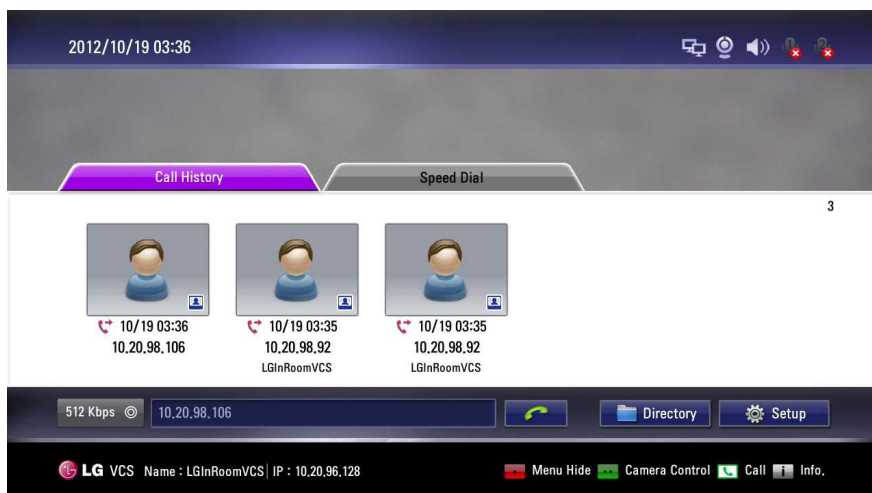
1. From the main screen, press the upper arrow [] button. The Call History tab is expanded.



2. Use the left [] or right [] button to select an entry.
3. Press **OK** to place a call. The call status dialog box is displayed.

NOTE

- To cancel the call, press **OK** during the dialing.
- If you use the Call History function during the call, you cannot use the Add and Delete function.

Placing a Call from the Directory

The directory stores a list of names and numbers from which you can place calls. To place a call from the directory, follow these steps:

1. From the main screen, press **DIRECTORY** on the remote control or select [Directory] on the main screen and press **OK** to access the directory.
2. Use the arrow buttons to select the entry that you wish to dial.
3. Press **OK** to place the call. The call status dialog box is displayed.

! NOTE

- Refer to the Directory setting section for more details.
- If you use the Directory function during the call, you cannot use the Add, Edit and Delete function.

Placing a Call using the Speed Dial

If you set a speed dial number, you can place a call quickly and easily. Press and hold the registered number button for a while until the call status dialog box appears.

Answering or Rejecting a Call

You can configure your system to automatically answer incoming calls by setting preferences in [User > General > Answer Type] menu as follows:

- Auto Answer: If you select this option, the system automatically answers the first incoming call.
- Manual: If you select this option, you must manually answer incoming calls. If your system is configured for answering calls manually, choose one of the following options when an incoming call arrives:
 - Select [Pickup] and press **OK** to accept the call.
 - Select [Reject] and press **OK** to reject the call.
- Do not disturb me: If you select this option, you can block the all of the call from the other system. The "Do not disturb" message is displayed in the middle of the top of the main screen. Missed calls appear in the Call History list. Consider using this feature, for example, if you are using the meeting room for a purpose other than a video conference and do not wish to be disturbed by incoming calls.



! NOTE

If you call to another system with the "Do not disturb" function enabled, the warning window is displayed and the call is disconnected automatically.

Managing a Call

During a call, you can view information about the status of the call and the identity of the connected caller.

Ending a Call

You can end a call using  on the remote control. Press  when you want to end a call. You will see a pop-up message and then select one or all when you end a multipoint call.

Hiding or Showing User Interface Elements

To hide or show the user interface elements at any time during a call, press .

Managing Audio

You can adjust the volume of the audio and mute the active microphone.



Adjusting Volume





To adjust the volume in a call, use **[VOL + / -]** on the remote control. If the volume is set to "0", audio output is muted and Mute icon  appears in the main screen.

NOTE

If the microphone is too close to the TV or some kind of speaker, Echo Performance can be bad condition.

Muting the Active Microphone

If you press  on the remote control or press  on the microphone, the active microphone is muted in a call. Refer to below table for mute condition.

		Activate	Deactivate
Symbol	On the screen		
	On the microphone		

Managing Video Layout

During a call, video from the connected caller appears in your monitor. You can change the screen layout of near and far end video.

Understanding Screen Layouts

Typically, screen layouts appear as the following types:

- A far end participant or a presentation appears on the left window.
- Your site (the near end participant) appears on the right window.

Changing the Screen Layout

1. During a call, press **LAYOUT** button to display the layout select window.

- The single point call layout window.



- The multi-point call layout window.

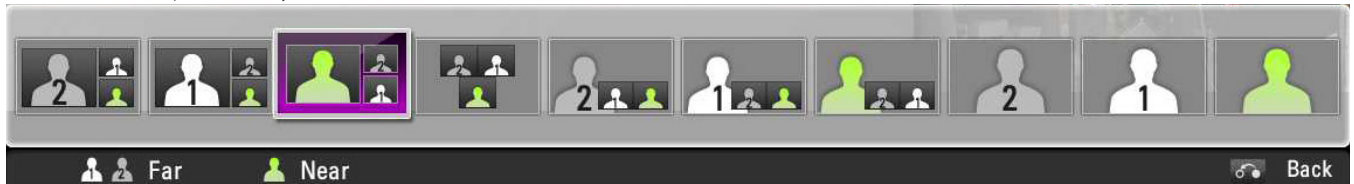

2. Selects the screen layout using left [<] or right [>] button.
3. Press **OK** to confirm.

Managing Video Contents

Changing the Video Source

You can change Main Camera screen to Contents screen during a call or idle status..

1. Connect the PC to the system with D-sub cable (see page 16).
2. Let out the video out correctly on your PC (e.g. Fn(Function) + F7 (LG laptop only) or Dual monitor setting)
3. Select the near end video and press **VIDEO SOURCE**. The Video Source Setting window is displayed.



4. Press **OK** and select [VGA Input] option and then press **OK**.

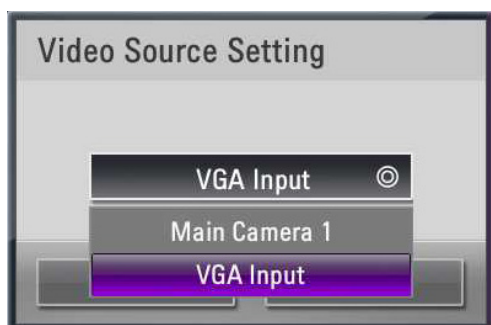

5. Select [OK] and press **OK**. The PC screen is displayed on the near end video window.

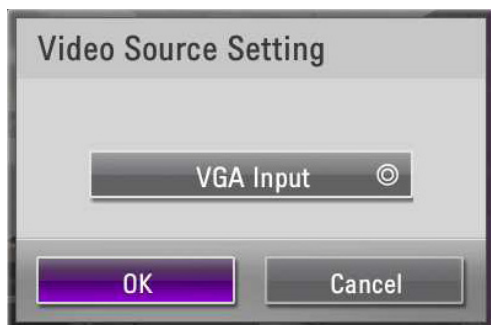

Sharing Content

If you want to share contents and camera video to far end site device by the real time during a call, the far end site have to support H.239. And you should set to H.323 on the [Setup>User>General>Outgoing Protocol].

1. Follow steps 1-2 described in "Changing the Video Source".
2. Press **PRESENTATION**.
3. You can select the type of sharing contents using by the Second Display option on the [Setup>User>General>Second Display].
 - If you set to Second display option to OFF, content and Main Camera screen will be displayed in one monitor (or TV).

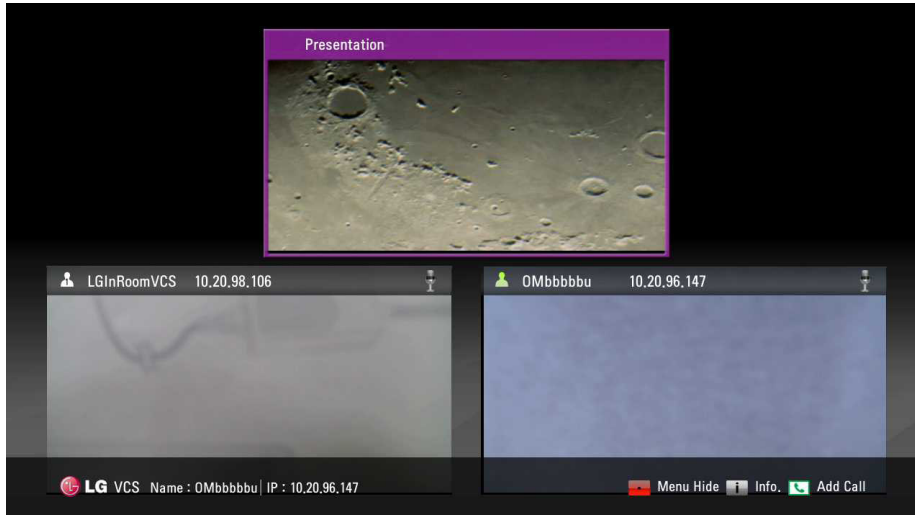

- If you set to Second display option to ON, Content and Main Camera screen will be displayed on two monitors (or TV) connected to each HDMI Port separately. The screen shows below table as the "Video Source Setting" of near end camera.

Video Source Setting	HDMI OUT 1	HDMI OUT 2
Main Camera 1	Camera Screen	Contents Screen
VGA Input	Contents Screen	Camera Screen



! NOTE

- This unit supports 640 x 480, 800 x 600, 1 024 x 768, 1 280 x 720, 1 280 x 768, 1 280 x 1 024, 1 400 x 1 050 and 1 920 x 1 080 and 60Hz for PC output resolutions.
- If the PC screen can not see properly after D-sub cable insert or remove from the VCS, check the PC video output connection again .

4. During a call, press LAYOUT button to display the layout with presentation select window.

- The single point call with presentation layout window.

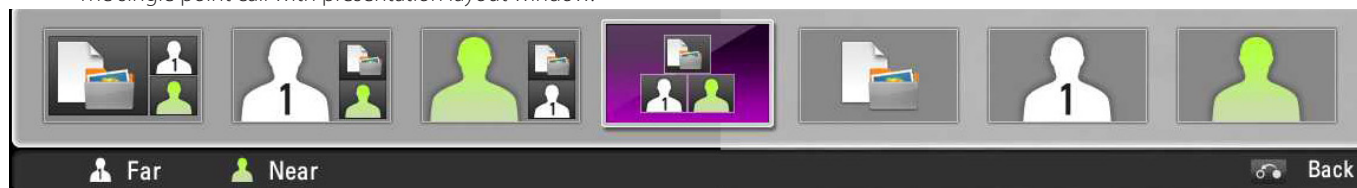

- The multi-point call with presentation layout window.

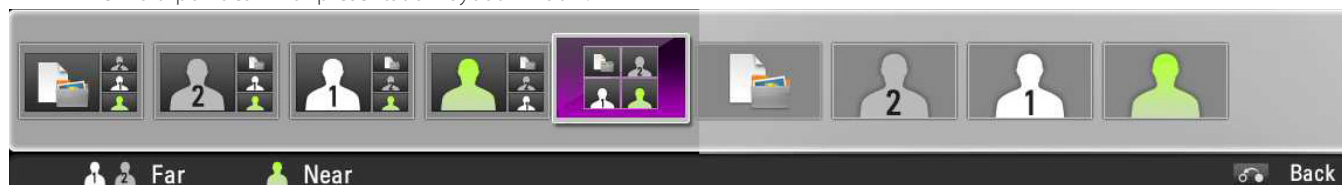

Viewing Call Information

You can view the call information.

1. During a call, press **i** (INFO).

The current call information window is displayed on the screen.

- Call Protocol: Shows the call protocol.
- Resolution: Shows the resolution, in pixels, of the video image transmitted or received.
- Video Frame Rate: Shows the video frame rate in frames per second.
- Video/Audio Codec: Shows the Video/Audio codec used to compress and decompress the Video/Audio.
- Video Packet loss/Audio Packet loss: Shows the number of packets of data that fail to reach their destination. Packet loss can be caused by a number of factors, including signal degradation over the network medium, oversaturated network links, corrupted packets rejected in-transit, faulty networking hardware, maligned system drivers or network applications, or normal routing routines.
- Video/Audio jitter: Shows the variation, in milliseconds, in the time between packets arriving, caused by network congestion, timing drift, or route changes.
- Video/Audio BW: Shows the amount of Video/Audio data transferred per second in kilobits.
- Cumulative: Shows the up to date count of packets lost in the call.
- Percentage: Shows packet loss as a percentage of the total packets sent.

2. Press **BACK** to exit.



Call information automatically refreshes every 1 seconds.

Get the Snapshot

During a call, you can get a snapshot of the current video image. It will be displayed in the entry of the Call History list.

Select the far end video window which you want and then press  to take a snapshot.

Managing the Directory

If you have access to the local directory, you can add, remove or edit entries.

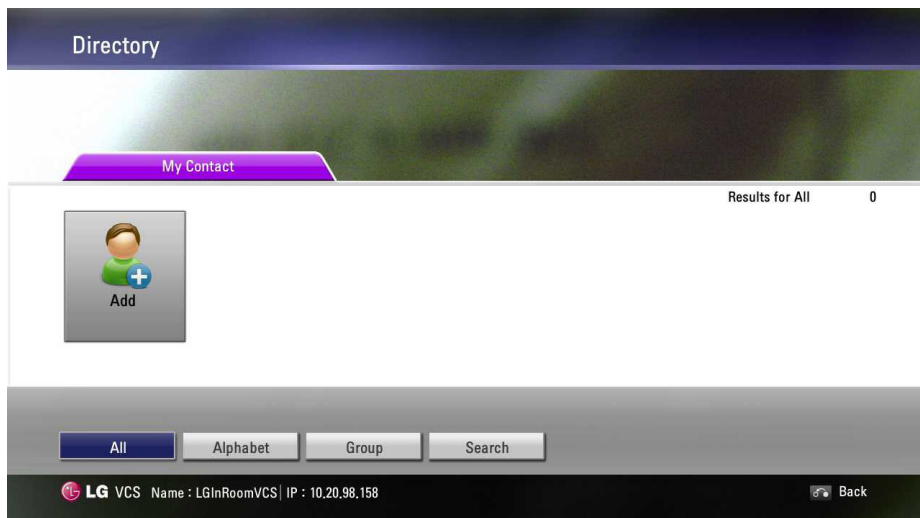

Adding an Entry to the Directory

You can create up to 1 000 entries in the directory. To add an entry in the directory, follow these steps:

1. From the main screen, press **DIRECTORY** on the remote control or select [Directory] button the main screen and press **OK** to access the directory.
2. Use the arrow buttons to select [Add] and press **OK** or press . The Add to Directory window is displayed.

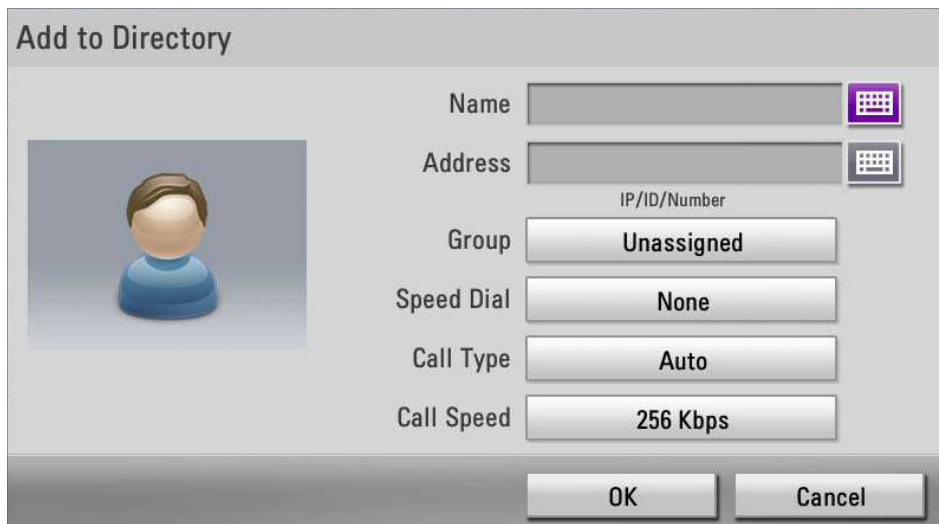

3. Use the arrow buttons to select the Name field. Press **OK** to enter a value. If necessary, use **1/a/A** to change the method of text entry for text fields or select the keyboard icon to display the virtual keyboard. After entering a value, hide the keyboard (if you used it to enter the value) and press **OK** to exit the field.
4. Use the arrow buttons to select the Address field. Press **OK** to enter a value. If necessary, use **1/a/A** to change the method of text entry for text fields or select the keyboard icon to displayed the virtual keyboard. After entering a value, hide the keyboard (if you used it to enter the value) and press **OK** to exit the field.
5. Use the arrow buttons to select the Group item and press **OK**. Select a group and press **OK**.

NOTE

If you make a new group, do the following steps.

- 5-1. Select [New] and press **OK**. The new group window is displayed.
- 5-2. Enter the new group name and press **OK**. Select **OK** of the window and press **OK** to confirm it.

- You can confirm saved entry in Speed Dial.

If you want to remove a saved Speed Dial number, you can remove by selecting in the Edit to directory.

- From the main screen, press **DIRECTORY** on the remote control or select [Directory] on the main screen and press **OK** to access the directory.
- Select the My Contact tab using the arrow buttons.
- Use the arrow buttons to move a modifying list and press **...**.
- Use the arrow buttons to select the Speed Dial item and press **OK**. Select a number to delete on the list and press **OK**.
- You will see a pop-up window, then press **OK**.
- Use the arrow buttons to select a Call Type item and press **OK**.
Select a call type and press **OK**.
- Use the arrow buttons to select the call speed and press **OK**.
- When you have completed the settings, select **OK** and press **OK** the remote control.

Editing or Deleting an Entry from the Directory

- From the main screen, press **DIRECTORY** on the remote control or select [Directory] on the main screen and press **OK** to access the directory.
- Select the entry you wish to edit and press **...**.
The Edit Directory window is displayed. If you delete the entry, select entry and press **.....** or **[DEL.]**. The Delete Contact window is displayed and you select [OK] and press **OK** on the remote controller.

- Modify values in the Edit Directory Entry dialog.

Copying an Entry from the Call History

You can copy an entry from the Call History list to the My Contact list.

- From the main screen, press the arrow up button on the remote control to access the call history.
- Select the Call History tab.
- Select the entry you wish to copy to the My Contact tab.
- Press **...**. The Add to Directory window is displayed.
- Select [OK] of the Add to Directory window. If you want to edit the item, change the value before you save it.
- Press **OK** on the remote control.

Copying an Entry from the Corporate Contact

When LDAP is enabled, Corporate Contact is displayed in the Directory.

- Enter Corporate Contact tab and select an entry and press **...**.
- Copy to My Contact window is displayed. Select [OK].
- Press **OK** on the remote controller.

Deleting an Entry from the Call History

1. Enter the Call History.
2. Select the entry you wish to delete and press  or [DEL].
3. The Delete History window is displayed.

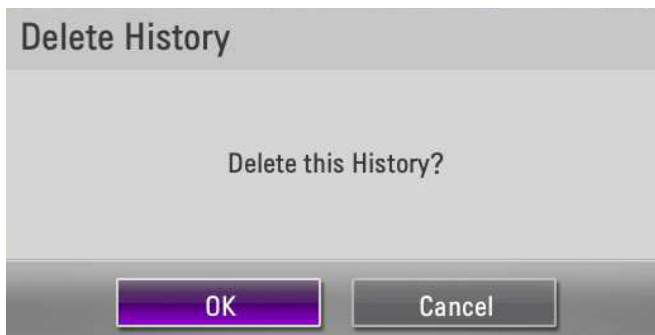

4. Select [OK] and press **OK** on the remote control.

Sorting and Searching

Basically, directories are sorted in the following order: special characters, numbers, characters.



- All: All entries are displayed.
- Alphabet: If the first letter of a name in the entries is included in the selected alphabet button, the entries are displayed.
- Group: If entries are included in the selected group button, the entries are displayed.
- Search: If the letter or special character in the name is included in the written character on the search field, the entry is displayed.

Placing a Call when the Device is Registered in Gatekeeper Server

You can place a call by entering the registered far site name in gatekeeper server.

1. You must confirm registered far site name in gatekeeper server.
2. Select the text input field and press **OK**.
3. Enter a registered far site name. Use **1/a/A** to change the method of text entry for text input field.
4. After entering a value, press **OK**.  is selected automatically.
5. Press **OK** again to place a call. The call status dialog box is displayed.

NOTE

- If you want to cancel the call, press **OK** while dialing.
- If you do not answer the call in 2 minutes, the system will disconnect the call automatically.

Making a Call when the Device is Registered in SIP Server

1. You must confirm registered far site name in SIP server.
2. Select the Text input field and press **OK**.
3. Enter an registered far site name. Use **1/a/A** to change the method of text entry for text input field.
4. After entering a value, press **OK**.  is selected automatically.
5. Press **OK** again to place a call. The call status dialog box is displayed.

NOTE

- If you want to cancel the call, press **OK** while dialing.
- If you do not answer the call in 2 minutes, the system will disconnect the call automatically.

Using the Camera Control

If the far/near site camera has the PTZ function, you can control the camera.

Idle condition of the near site camera

1. Press  on the remote control. The control icon is displayed on the screen.

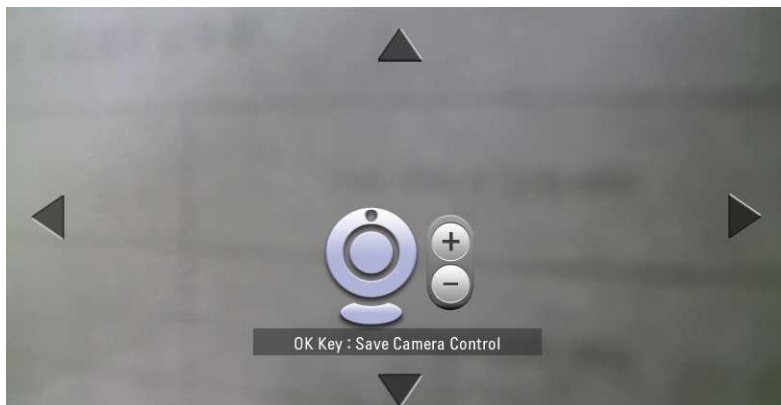

2. You can control near site camera by pressing **CAM ZOOM +**, **CAM ZOOM -** and Arrow buttons.
3. Press **OK** to save the settings.

During the call

1. Select the site window using the arrow buttons.
2. Press **OK** on the remote control.
3. You can control the selected site camera by pressing **CAM ZOOM +**, **CAM ZOOM -** and Arrow buttons.
4. Press **OK** to save the settings.

Using Preset function

If the site camera has the PTZ function or another video source, you can use the preset function.

To register the preset position

1. Control the site camera to the location as you want using the **CAM ZOOM +**, **CAM ZOOM -** and Arrow buttons. Press **OK**. Before you start the preset setting, you should select the site you want to set the preset during the call.
 2. Press **PRESET** on the remote control. The preset window is displayed.
 3. Select the preset number you want to save using the left or right arrow button.
 4. Press **OK** to save the preset.
 5. Press **BACK** to exit the preset setting.
- or
1. Press **PRESET** on the remote control. The preset window is displayed.
 2. Select the [Select Site] icon and press **OK**. Select the site you want to set the preset.
 3. Select the preset number you want to save using the left or right arrow button.
 4. Press  on the remote control. The control icon is displayed on the screen.
 5. Control the site camera to the location as you want using the **CAM ZOOM +**, **CAM ZOOM -** and Arrow buttons.
 6. Press **OK**. Then you will be able to save the location at that number.
 7. Press **BACK** to exit the preset setting.

To use the preset

You can control the site camera to the saved location by selecting the saved number.

1. Press **PRESET** on the remote control. The preset window is displayed.
2. Select the preset number and press **OK**. The camera move to the saved location.

Using SnapShot

You can save entry on directory with the far site user screen picture.



1. Connect to the far site.
2. Press  on the remote control.
"Snapshot of Far side is saved" is displayed on the screen.



NOTE

- You can confirm this snapshot information in the Call History.
- You can save entry with this snapshot information in the My Contact list.

Using Power Off

Press the  button on the remote control more than 3 seconds, the [Power Off] window is displayed. Click **OK** to turn off the software. Press the  button again to power on the software. If you power on the software, the screen returns to normal after reboot.

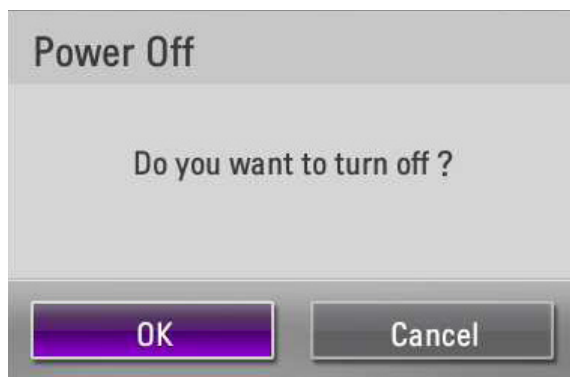

Using the Web Service

You can perform the same configuration from the web interface that is available from the unit. The web interface contains additional features that cannot be configured on the unit. You can also update the system, upload certification, import or export address book in the web service.

Login the web service

1. Run the web browser.
The recommended browser is Internet Explorer with Windows.
2. Enter "http://" and the IP address of the VCS in the Address Box.
You can use the Host Name that you entered in the DDNS setup menu of the VCS.
3. Press ENTER on the keyboard and then the LG VCS Web service login page will be displayed.



4. Select the ID and enter the password. The default password is "lge123" for Administrator and "lge456" for User 01 to User 04.

NOTE

- Up to 5 users can connect to the Web Service.
- When you close web service, you should click logout button on the right up side of web page. If you log in and find the below pop-up message, click OK button and try to log in again after 30 seconds, you can log in.

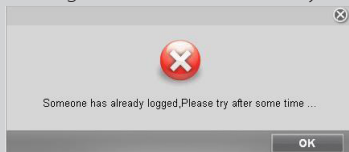

- You can change the password on the Web Service. Click the ID where is top right of the main screen. The [Change ID & P/W] window will be displayed. Enter the [Current Password], the [New Password] and the [Retype New Password] and then Click OK to save.

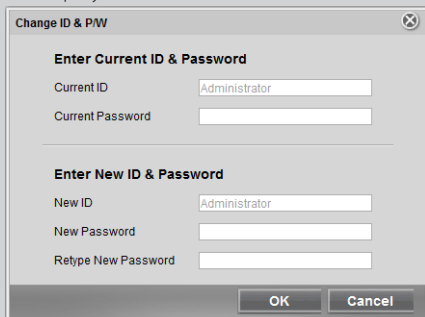

Using the web monitoring function

1. Follow steps 1-4 described in "Login the web service".
2. Select the [Call Manager] tab. You can show the far end camera video during the call.

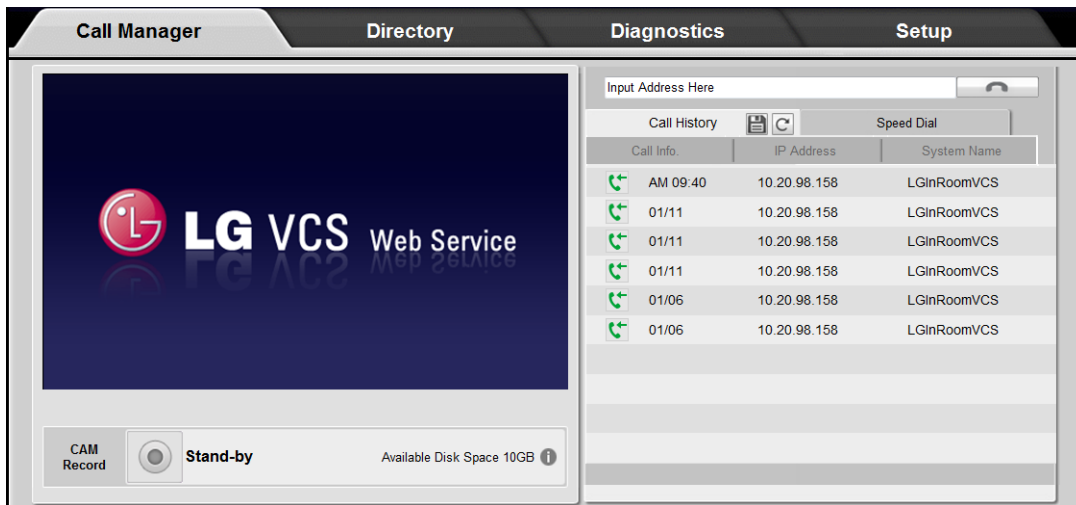

NOTE

- If you find this message "Please [Click here](#) to install Active-X component to avail monitoring and [refresh](#).", click the [Click here] and install the ActiveX program on your computer. After install the Active-X program, you should refresh the web browser. Click the [refresh] and then click the yellow bar and install the Active-X program again.
- If setup message still appears despite installation, VLC Player might not be the recommended version. Click the [Click Here] on the "If VLC is installed already, [Click Here](#)." message and then check the installation guide.
- When you find this message "VLC might not be installed, please [Click here](#) to install it to avail monitoring.", click the [Click here] to move the setup page and install the VLC program. Install the recommended version, or recording cannot run. You should access the web browser again after installation. If the yellow warning bar is displayed, click the bar and install the plug-in program.
- If video stream is blurred or not clear, please click refresh button on web browser or press "F5" on keyboard. (Internet Explorer Only)
- Web monitoring is not supported while AES encryption is activated during a call.

Using the web recording function

1. Follow steps 1-4 described in "Login the web service".
2. Select the [Call Manager] tab.
3. Place a call. The far end camera video is displayed.
4. Click the [CAM Record] button on the Call Manager tab. The initial save folder is "C:\lgvcs\recording".
If you want to change the folder, select the [Setup] > [Administrator] > [Call] > [General] and set the new folder before you start to record it. (Target folder is restricted to Local Hard Disk Drive.)

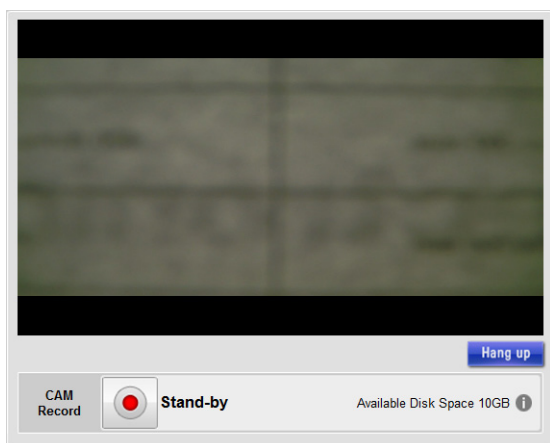

CAUTION

- LG Electronics is not held responsible for recording failure caused by web recording function.
- The system may have a problem as VCS or network condition. So you should use the safe recording server for the important conference session. If you purchase the safe recording server, please contact where you purchased.
- If call is added or disconnected while recording, recording is halted temporarily and will be restarted with new recording file.
- Video Clip Information is like as below.

Items	Information
Video Codec	MPG2 - Ffmpeg Decoder
Input / Output Type	MPG2 (0 bits) / YUV2 (16 bits)
Input / Output Size	704 x 576 (1.22:1)
Minimum Disk Space for recording	4 GB
Video Player	VLC media player (See page 60.)

- Minimal H/W Requirement to use the web recording function Intel Core 2 Duo CPU P8800 2.66GHz 1.57GHz 3.00GM RAM. The Web service spec recommends Windows XP(Internet Explorer 6.0 and 8.0) and Windows 7(Internet Explorer 8.0).
- Restart like as below when the recording conflicts occurred.
 1. It may cause memory shortage for recording. Reboot the PC.
 2. Change the configuration of the control panel firewall in Windows 7 case. Select VLC media player option on the [Control Panel > Windows Firewall > Allow a program or feature through Windows Firewall > Allowed programs and features(A):] and then check the check box of Domain, Home/Work (Private) and Public option.
- Video Frame may be dropped partially according to PC performance when you conduct Web recording.

Upgrading your System Software

To upgrade the software for your system, follow these steps:

1. Follow steps 1-4 described in "Login the web service".
2. Select the [Setup] tab.
3. Select the [Administrator] > [System] > [Management] option.
4. Click [Upgrade] of the [System Update] option.

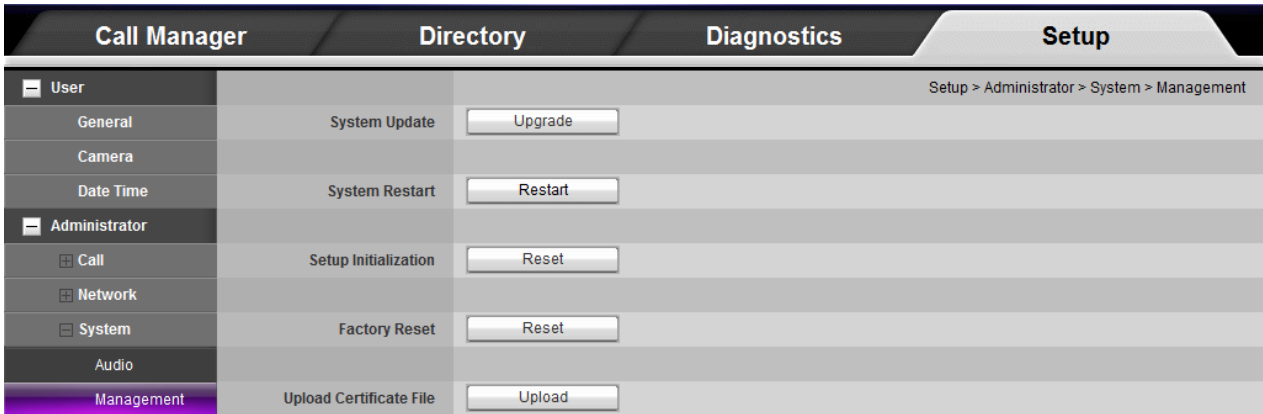

5. Click [Browse].

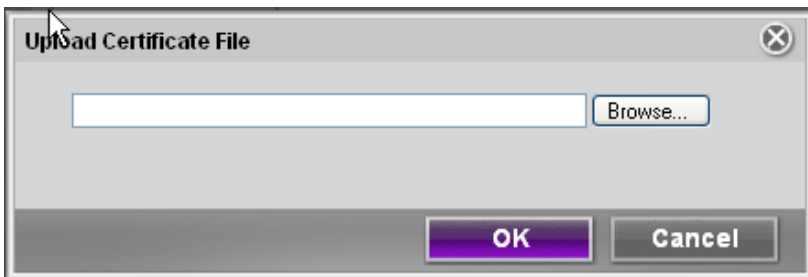

6. Find and open the firmware file.
7. Click [OK]. The system upgrade status bar is displayed.
8. After upgrading is complete, a confirmation window will be displayed. Click [OK] and the system will be rebooted.
9. If you use the web service after updating, access the web service again as IP address after the system is rebooted.

NOTE

Before updating, reboot the VCS. Otherwise update may not work properly.

Uploading the Certification File

1. Follow steps 1-3 described in "Upgrading your System Software".
2. Click [Upload] of the [Upload Certificate File] option.
3. Click [Browse].
4. Find and open the certificate file.
5. Click [OK].

Importing or Exporting the Address Book

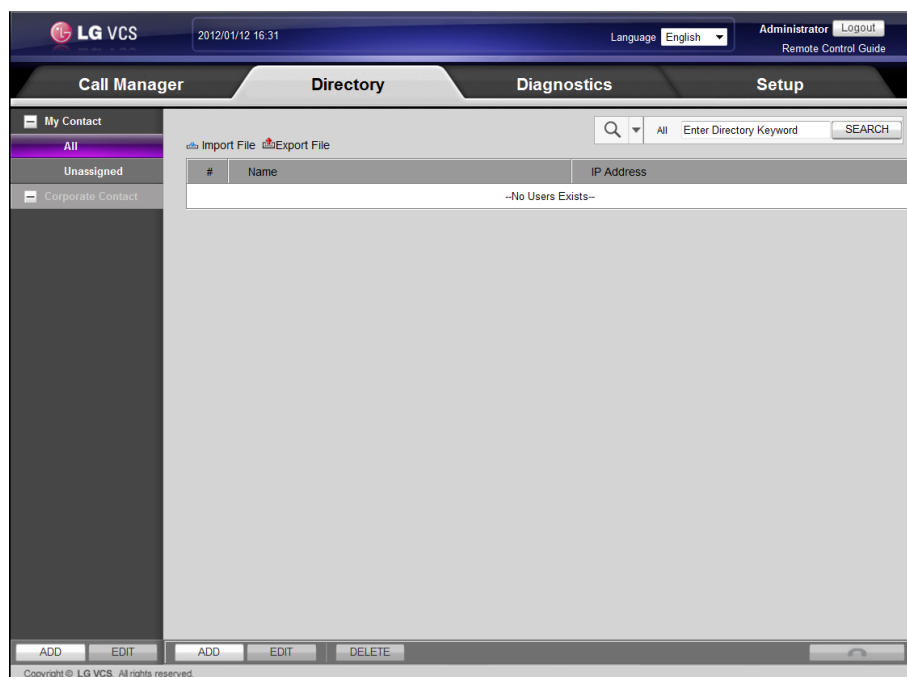

Exporting the Address Book

1. Follow steps 1-4 described in "Login the web service".
2. Select the [Directory] tab.
3. Click the [Export File] menu. The exporting window is displayed.
4. Click [Save].
5. Select the folder and modify the export file name.
6. Click [Save].

Importing the Address Book

1. Follow steps 1-4 described in "Login the web service".
2. Select the [Directory] tab.
3. Click the [Import File] menu. The Import CSV File window is displayed.
4. Find and open the address book file and then click [OK]. The imported address will be added and you can see the added address on the list.
5. Import can be performed by Administrator only.

5 Appendix

Troubleshooting

Symptoms	Resolutions
The system power does not turn on.	Check the power cable is connected correctly.
	Check the input voltage is correct.
	Check the main power switch is turned on.
	If the system power does not turn on even if the power cable is connected correctly, please contact the service center.
The system power is turned on but no video data is displayed on the monitor.	Check the input mode of the monitor.
	Unplug the power cable and plug in again.
The subject is not clear enough to see.	Adjust the camera brightness and white balance in User > Camera tab
The remote control is not working.	Check the batteries.
	Make sure that the battery polarity are connected with (+) and (-) matched correctly.
	Check the remote control contains two AAA batteries that are in good working condition.
	Verify whether objects are obstructing the sensor on the front of the camera.
	Check that the camera cable is connected correctly on device when you use the remote control. You can confirm camera connection status as camera icon in main screen
The image is not visible.	Check that the camera cable is connected correctly on device. You can confirm camera connection status as camera icon in main screen. If you connect Camera Input HDMI Cable to HDMI TV or Monitor or If you connect Codec Box's HDMI Out Cable to Camera HDMI Input Port, it can cause malfunction (Color noise or not visible). So Check HDMI Cables Connection.
The sound is not audible.	Muffled audio reception from the far side may be caused by highly reverberant rooms.
	If you are experiencing poor audio reception, add more sound absorbency to the room and speak in close proximity to the microphone.
	Ensure both ends are not muted. Verify that the audio out cables are properly connected to the monitor and that any external speaker systems are powered and configured correctly. Also check your Audio Out setting on your audio device (HDMI, Line-out).
	Make sure your Audio Out preference in [Admin > System > Audio] for your sound device. If you are unable to hear the ringer when an incoming call arrives, adjust the ring tone preference in [Admin > System > Audio].
The system does not work with the remote control.	Reboot the system that is not responding to commands from the remote control.

Video or audio are poor.	After connecting to a call, if audio or video do not display normally, users can attempt to connect after the codec box is set to low bandwidth.
You hear a distinct echo.	<p>If You Use HDMI TV or Monitor</p> <ul style="list-style-type: none"> Adjust the volume of the HDMI TV or monitor so that it is not too loud. Adjust that microphone location is not too close to the HDMI TV or monitor. (1 m or more) Run the Audio out test at the [System info > Audio] menu. <p>If You Use External Speakers</p> <ul style="list-style-type: none"> Adjust the volume of the external speakers so that they are not too loud. Adjust that Mic location is not too close on External speaker (approximately 1 m or more).
You cannot make a call.	If a call does not successfully connect, verify that you have dialed a working number and that the far end destination is powered on and available. Verify that the network is ready and available. Network status is indicated at all times on the main screen.
	You can confirm that you can connect from your local IP to remote site IP by using the ping function in the Network utility.
	You confirm that you are using proper call protocol (H.323 or SIP). If you set H.323 or SIP about outgoing protocol, the far site device must be set to the same protocol like near site.
	If you can't solve this problem, please contact the service center.
Severe freezes and broken video during call.	<ul style="list-style-type: none"> Try to call using lower video bitrate (e.g. Setup > Admin > Call > General > Maximum Bandwidth). Check with each site's IP operators that your video UDP traffic is NOT being blocked by IPS (Intrusion Protection System). Check the remote user's VCS video capability. <ul style="list-style-type: none"> What video resolution is supported: HD 720p, SD 720x480 What video codec is supported: H.264, H.263, H.264HP
Can not see the PC screen after pressing [VIDEO SOURCE] or [PRESENTATION].	<ul style="list-style-type: none"> Check that the D-sub cable is connected properly between the PC and the VCS. Check that the PC's video out resolution is properly selected (e.g. 640X480, 800x600, 1024x768, 1280x720, 1280x768, 1280x1024, 1400X1050 and 1920X1080). Make sure that you let out the video out correctly on your PC (e.g. Fn + F7 or dual monitor setting).
The PC screen is shifted after [VIDEO SOURCE] or [PRESENTATION] has been pressed.	<p>Check that the D-sub cable is connected properly between the PC and the VCS.</p> <ul style="list-style-type: none"> Change the D-sub cable.
I can't access the web server.	<ul style="list-style-type: none"> Check your VCS device's network accessibility. <ol style="list-style-type: none"> Check the IP address, subnet, and gateway for typos when using a static IP. Check that the IP address is correctly shown on the OSD using DHCP IP. Connect a different PC to the same network and try to ping to your VCS IP address (e.g. ping 10.177.217.22). Try to disable / enable the web server menu via Setup. <ol style="list-style-type: none"> Go to Setup > Admin > Network > Service > Web Server. Set Off and exit from setup. Go back to the Web Server setting, set to On and return to the main screen or try to turn the power off then back on again.
The remote user is not able to hear your voice.	Check microphone status (see page 28).
The current input video of the local camera displays the flickering image.	Use Shutter function to match your lighting conditions in [User> Camera] menu.

The call is connected by audio only although you set to [Audio+Video] on the [Setup>User>General> Call Mode].	Check the remote user's VCS video capability. The call is connected by audio only in case the codec which supported LG VCS is not compatible with the video codec of Far End user. <ul style="list-style-type: none">- What video resolution is supported: HD 720p, SD 720x480- What video codec is supported: H.264, H.263, H.264HP
---	--

Open Source Software Notice

To obtain the source code under GPL, LGPL, MPL and other open source licenses, that is contained in this product, please visit <http://opensource.lge.com>. In addition to the source code, all referred license terms, warranty disclaimers and copyright notices are available for download. LG Electronics will also provide open source code to you on CD-ROM for a charge covering the cost of performing such distribution (such as the cost of media, shipping and handling) upon email request to opensource@lge.com. This offer is valid for three (3) years from the date on which you purchased the product.

Specifications

ITEM		V5000, V5500	VR5010H
Communication	Signal Protocol	H.323, SIP	
	Multi way call	1 to 3 (inner MCU)(V5500), 1 to 1 (V5000)	1 to 1 (VR5010H)
Video	Video standard	H.263, H.264BP, H.264 HiP	
	Resolution	All resolutions progressive Scan	
		All resolutions at 30fps	
		CIF/SIF	
		4CIF/4SIF	
		1280x720p	
Camera	Camera type	1/2.8 Type 3M CMOS / F1.6 (wide), 2.3(tele)	1/2.8 Type 3M CMOS / F1.6 (wide), 2.2(tele)
	Resolution	720p, 30 fps	
	Zoom	x12 optical	x7 optical
	Focus	Auto	
	View range	6 degree to 72 degree	11 degree to 72 degree
	Pan/Tilt range	±100° / +20° ~ -30°, FOV 72°	
	Backlight (WDR)	YES	
	Min. Illumination	15 lx (F1.6) with 50 IRE	
	IR Detector	YES	
	interface	HDMI, D-Sub to RJ45 for Signal and Power	
Audio	Standard	G.711, G.722, G.722.1, G.722.1C	
	Features	Ring tone	
		Full duplex for natural conversations	
		Echo cancellation for echo-free calls	
		Automatic noise reduction	
		Automatic gain control	
Other Supported Standards		H.323, H.224, H.281 H.225, H.245, H.241, H.460, H.239	
Contents sharing	Dual Stream contents sharing		
User Interface	Graphic base easy User Interface		
	Graphical User Interface Call Manager		
	Snapshot / Thumbnail display		
	up to 15 languages		

Network	IPv4		
	AES		
	NAT / Firewall Client (H.460.18/19)		
	IP Precedence for QoS		
	Intserv (Integrated Service), DiffServ (Differentiated Service) for QoS		
	Adaptive QoS, bitrate control(frame rate, resolution control)		
	Lost Packet Recovery for QoS		
	Dynamic bandwidth allocation for QoS		
Directory & Address Book	Up to 1 000 local directory entries		
	Save, Remove Redial List features		
	Missed call notification		
	LDAP support / H.350 compliant		
System Management	Web-based system management		
	SNMP v1/v2		
	Network Time Protocol (NTP)		
	Firmware Upgrade via Web		
Recording	Web Recording		
Security	Secure password authentication		
	Ability to disable HTTP services		
	H.235 (AES) encryption support including strict compliance		
	SSH and Telnet services		
	IEEE 802.1x support		
	Kensington Security Slot™		
Environmental Data(Camera)	Operating temperature	0 °C (32 °F) to 40 °C (104 °F)	
	Operating Humidity	15 % to 80 %, non-condensing	
	Storage temperature	-20 °C (-4 °F) to 60 °C (140 °F)	
	Storage humidity	15 % to 80 %, non-condensing	
Environmental Data(Codec)	Operating temperature	0 °C (32 °F) to 40 °C (104 °F)	
	Operating Humidity	15 % to 80 %, non-condensing	
	Storage temperature	-20 °C (-4 °F) to 60 °C (140 °F)	
	Storage humidity	15 % to 80 %, non-condensing	
Dimensions (Camera)	Width	215.5 mm	219.7 mm
	Depth	144 mm	149.1 mm
	Height	154.5 mm	159.7 mm
	Weight	1.55 kg	1.48 kg

Dimensions (Codec)	Width		400 mm
	Depth		187 mm
	Height		42 mm
	Weight		3.0 kg (Without Stand: 2.35 kg)
Interface			Audio Input (2 x MicPod, 1x RCA)
			Audio Output 1x RCA
			Camera Input (1 x HDMI)
			D-Sub Video In (1 x VGA)
			HDMI Video Out (2 x HDMI 480p, 720p), 2nd Video Out supports the contents only
			LAN Port :1 x RJ-45, 10/100/1000 Mbps
			Power (1 x DC Input)
MicPod			3.5 mm Micpod with Mute
Power Adaptor	Type/model		FSP060-DBAC1
	Rating	Input	100-240 V~, 50/60Hz,1.5 A
		Output	DC 12 V, Maximum 5.0 A

**NOTE**

AES function may not be supported in specific countries.

