



LG

Life's Good

OWNER'S MANUAL

LG HEAT PUMP DRYER

Please read this manual carefully before operating your dryer and retain it for future reference.

RC9055AP3Z / BP3Z

RC9055AP2Z / BP2Z

RC9055AP1Z / BP1Z

RC9055APZ / BPZ



P/NO. : MFL63749075

www.lg.com

F eatures



● Ultra Big Capacity Drum

The ultra big 9.0kg capacity drum on this LG dryer allows you to dry more washing at once, saving time!

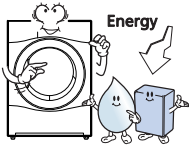

● Lower Energy Consumption

LG Heat Pump dryers use less energy than conventional dryers due to an optimized heat exchanger and auto cleaning™ technology. This LG Heat Pump dryer has been designed to save your money.

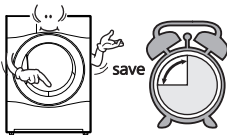

● Reduced Drying Times

Drying times are now shorter due to LG's Hybrid Peating System and the optimized heat exchanger on this LG dryer.

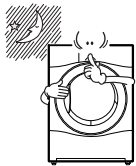

● Reduced Noise Levels

We have reduced the operating noise of this LG dryer by using innovative sound-absorbing and noise-screening technologies, making it much quieter than conventional dryers.

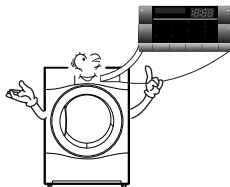

● Ease of Use

The wide, electronically controlled LED display on this machine is very easy to use. Simply select the cycle you require and your LG dryer will do the rest. Smart Diagnosis™ is available.

C ontents

Safety Instructions	3
Installation Instructions	6
Appearance & Design	10
Operating Your Dryer	11
Additional Functions	15
Caring for Your Dryer	17
Additional Tips for Smart Use	19
Troubleshooting Guide	22
Technical Data	25
Warranty	26

Safety Instructions

For your safety, the information in this manual must be followed to minimize the risk of fire or explosion, electric shock, or to prevent property damage, injury to persons or death.

⚠ WARNING

- Serious injury or death may occur when not observing the following rules.
- It is strictly forbidden to use the product for anything other than the manufacturer authorized usage. LG doesn't take full responsibility for the damage by inaccurate and improper use.
- Do not repair or replace any part of the dryer or attempt any servicing unless specifically recommended in the user-maintenance instructions or published user-repair instructions that you understand and have the skills to carry out.

⊘ Hazards

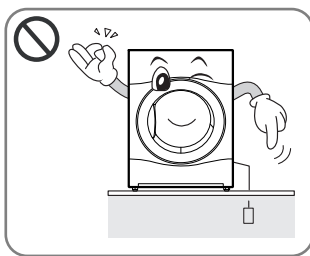

- Before plugging in the power cord, make sure the cord is earthed and connected to a circuit breaker.

.....

No earthing may cause breakdowns or an electric shock.

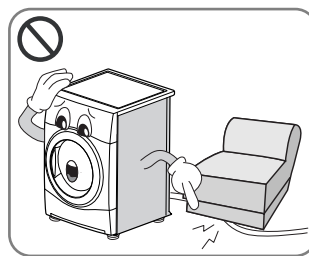

- Do not use a damaged power cord or place heavy objects on the cord.

.....

A damaged power cord may cause fire or electric shock.

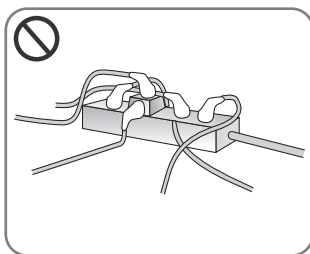

- Do not plug into an adaptor. Do not use with an extension lead.

.....

Abnormal heating of outlet may cause a fire.



- Do not touch the plug or switch with wet hands.

.....

May cause an electric shock.

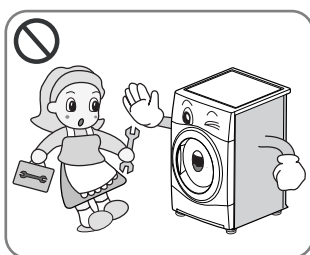

- Do not remove the top plate when installing the dryer.
- Do not modify this product.

.....

May cause breakdown, fire or electric shock.

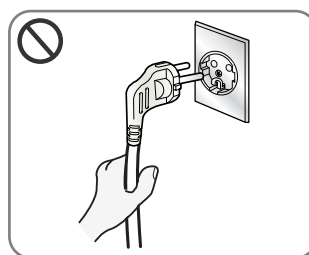

- Disconnect the power by grasping the cord, not the plug.

.....

May cause damage of cord resulting in fire or electric shock.

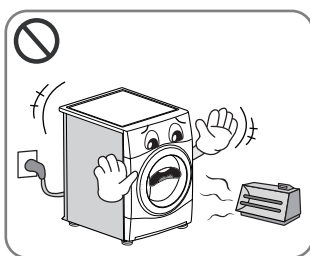

- Keep the dryer away from cookers, naked flames, or any other inflammable objects.

.....

May cause fire or parts to melt.

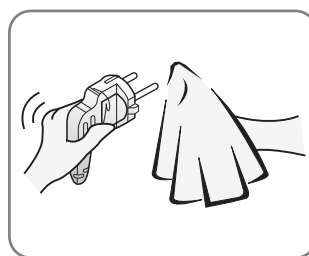

- Wipe dirt and stains from the power cord and insert the plug firmly into the socket.

.....

Dirt and poor connections may cause fire.

Safety Instructions

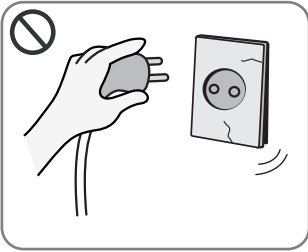

- Do not use if power cord, plug or socket is damaged.

May cause fire or electric shock.

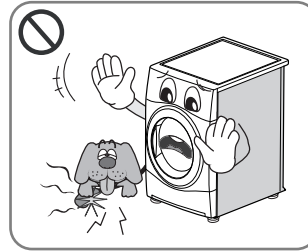

- Keep pets away from the dryer.

Pets may damage the dryer, or may receive an electric shock.

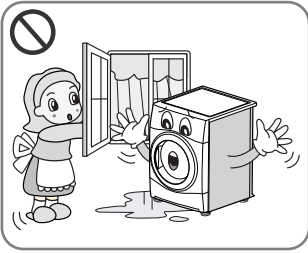

- Do not install or store the dryer where it will be exposed to the weather.

May cause fire, electric shock or malfunction.

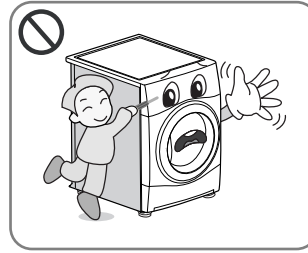

- Do not press buttons using sharp implements such as knives and screwdrivers.

May damage the dryer or cause electric shock.

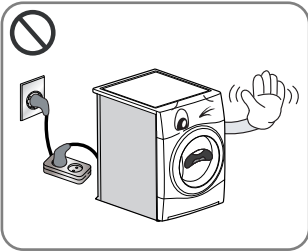

- Do not use an extension cord or an adaptor to connect to the power.

May cause fire or electric shock.

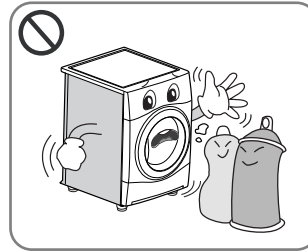

- Do not dry articles that have been cleaned in, washed in, soaked in, or spotted with combustible or explosive substances (such as wax, oil, paint, gasoline, degreasers, dry-cleaning solvents, kerosene, etc.).

May cause fire or explosion.

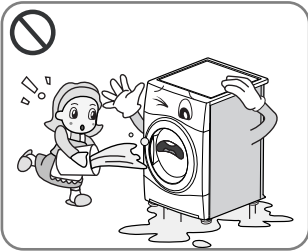

- Do not splash water on to the dryer.

May cause fire or electric shock.

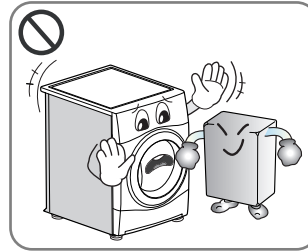

- Do not place flammable items near the dryer.

May cause toxic gases, parts damage, fire or explosion.

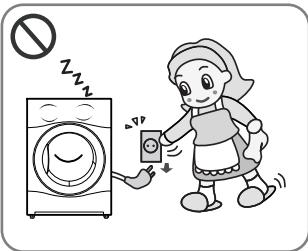

- Unplug the power cord when cleaning or not using the dryer.

Water or dirt may cause an electric shock.

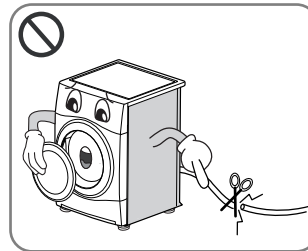

- Before the appliance is removed from service or discarded, unplug the appliance then disassemble the door and cut off the power cord to prevent misuse.

May cause accident and injury.



- Do not allow children or pets to play on or inside the dryer.
- The appliance is not intended for use by young children or infirm persons without supervision.
- Young children should be supervised to ensure that they do not play with appliance.

Children and pets may injure or suffocate themselves.

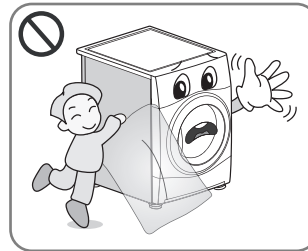

- The packing bag is not a toy. Destroy after opening.

To avoid the possibility of suffocation, keep the packing bag away from babies and children.

Safety Instructions

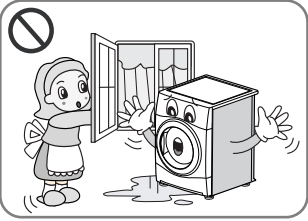

- If this appliance is supplied with power from a cord extension set or an electrical connector, the portable outlet device must be positioned so that is not subject to damp or splashing.

.....
It may cause an electric shock, a fire, malfunction or deformation.

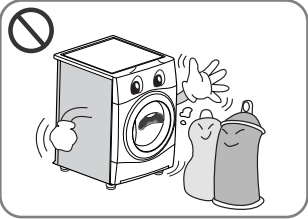

- Items that have been spotted or soaked with vegetable or cooking oil constitute as a fire hazard and should not be placed in the tumble dryer.
- Items that have been soiled with substances such as cooking oil, acetone, alcohol, petrol, kerosene, spot removers, turpentine, waxes and wax removers should be washed in hot water with an extra amount of detergent before being dried in the tumble dryer.

.....
May cause spontaneous combustion leading to explosion and fire.

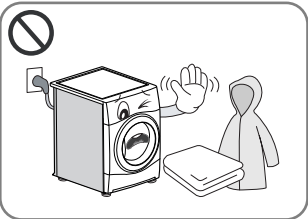

- Items made of foam, rubber, plastic, or other heat-sensitive fabrics (such as bathroom rugs, nonslip mats or raincoats) should not be dried in a tumble dryer on a heat setting.
- Items such as foam rubber (latex foam), shower caps, waterproof textiles, rubber backed articles and clothes or pillows fitted with foam rubber pads should not be dried in the tumble dryer.

.....
May cause spontaneous combustion leading to explosion and fire.



- Plastic articles such as shower caps or waterproof nappy covers should not be placed in the tumble dryer.

.....
May cause spontaneous combustion leading to explosion and fire.

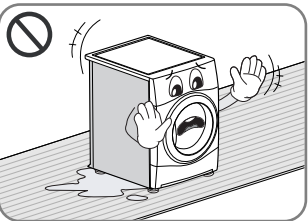

- If the tumble dryer is installed on a carpet, it may be damaged due to poor air ventilation.

.....
May cause spontaneous combustion leading to explosion and fire.

- Fabric softeners, or similar products, should be used as specified by the fabric softener instructions.
- To reduce the risk of injury to persons, adhere to all industry recommended safety procedures including the use of long sleeved gloves and safety glasses. Failure to follow all of the safety warnings in this manual could result in property damage, injury to persons or death.

I nstallation Instructions

The following instructions will guide you through the initial steps of setting up your dryer. Please note that every section of this manual provides important information regarding the preparation and use of your dryer, and it is important that you review this entire manual before proceeding with any installation or use. Be sure to observe all listed warnings and cautions. These installation instructions are intended for use by qualified installers. Read these installation instructions completely and carefully.

Safety Information

Risk of Injury

The dryer is very heavy so you shouldn't try to lift it alone.

Do not lift the dryer by grasping any of the protruding parts, e.g. the jog dial or the door, they may break off.

Risk of Falling or Tripping Up

Ensure there are no loose hoses or cables.

Check the dryer for damage occurred during transportation.

Do not connect the dryer if it has visible signs of damage.

If you are not confident, contact your local LG agent. Always empty the dryer completely before transporting it.

Your dryer should not be located near to a gas hob, cooker, heater or grill, as flames from the burners could damage your dryer. When the dryer is fitted beneath a work surface, allow 30cm~50cm space at either side of the dryer and at the back of the dryer to allow air to exit the rear grille. This air flow is critical for condensation of water during the drying process.

If you use this dryer near or stacked on top of your washing machine, separate main plugs and sockets must be used for each appliance. Do not use 2-way adaptor or extension lead.

You can stack the dryer on top your washing machine to save space. A stacking kit is available from your local appliance specialist.

Stacking Installation Instructions

Your LG dryer can be placed on top of a front loading washing machine and securely fixed with a stacking kit (see following page for instructions). This installation must be conducted by an experienced installer to ensure it has been installed correctly.

An installer will ensure you have the correct stacking kit for your model of washing machine and will ensure it is firmly fixed. For these reasons, expert fitting is essential.

⚠ CAUTION

CAUTION Concerning the power cord

Most appliances recommend they be placed upon a dedicated circuit; that is, a single outlet circuit which powers only that appliance and has no additional outlets or branch circuits. Check the specification page of this owner's manual to be certain.

Do not overload wall outlets. Overloaded wall outlets, loose or damaged wall outlets, extension cords, frayed power cords, or damaged or cracked wire insulations are dangerous. Any of these could result in an electric shock or fire. Periodically examine the cord of your appliance, and if its appearance indicates damage or deterioration, unplug it, discontinue use of the appliance, and have the cord replaced with an exact replacement part by an authorized servicer.

Protect the power cord from physical or mechanical abuse, such as being twisted, kinked, trapped in a door, or walked upon. Pay particular attention to plugs, wall outlets, and the point where the cord exits the appliance.

Installation Instructions

Stacking Kit

In order to stack this dryer an LG stacking kit is required.

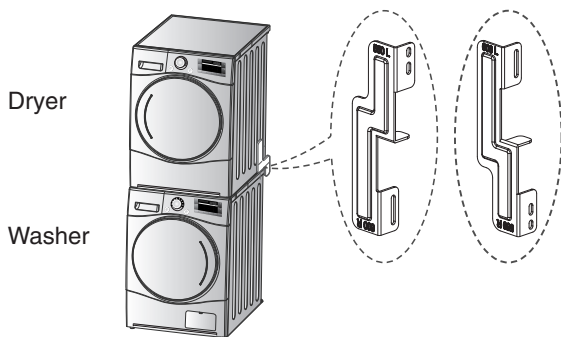

This dryer may only be stacked on top of an LG washer. DO NOT attempt to stack this dryer on any other washer, as damage, injury or property damage could result.

Shape and assembly direction	Washer Top plate size	
	21.7 inch (550mm)	23.6 inch (600mm)

Installation Procedure

1. Place the LG dryer on the LG washing machine.
2. Remove the two screws from the bottom of the rear cover on each side as illustrated below.

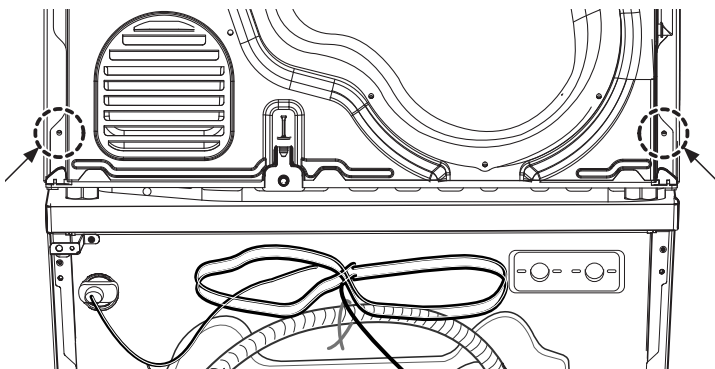

WARNING

- Incorrect installation can cause serious accidents.
- The weight of the dryer and the height of installation makes the stacking procedure too risky for one person. This procedure should be performed by 2 or more experienced service personnel.
- The dryer is not suitable for a built-in installation. Please do not install as a built-in appliance.
- Do not operate if the dryer is disassembled.

3. Align the stacking kit holes and the rear cover holes.

3-1) 23.6 inch(600mm)

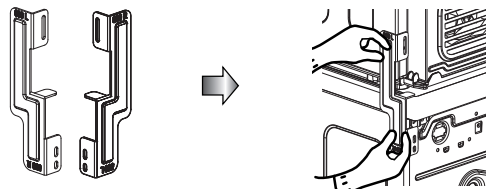

3-2) 21.7 inch(550mm)

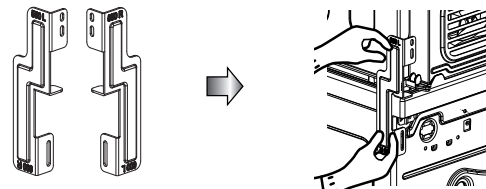

- Fasten the 2 screws that were removed earlier from dryer to stacking kit.
- Use 4 screws in accessory box [0.6inch(16mm)] to assemble washer rear cover and stacking kit.
- The procedure for the opposite side will be the same.

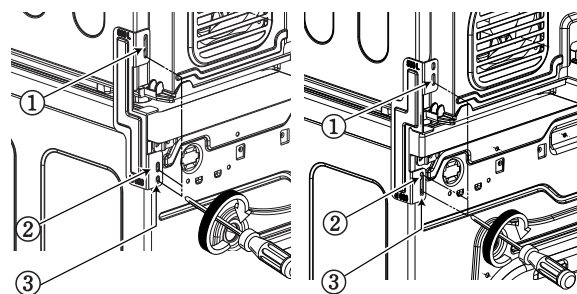

I nstallation Instructions

Earthing Instructions

This appliance must be earthed. In the event of malfunction or breakdown, earthing will reduce the risk of electric shock by providing a path of least resistance for the electric current.

This appliance is equipped with a earthed cord and an earthing plug. The plug must be plugged into an appropriate outlet that is properly installed and earthed in accordance with local Standards.

Additional Grounding Procedure

Some countries may require a separate ground. In such cases, the required accessory ground wire, clamp and screw must be purchased separately.

Condensed Water Drain

This appliance can be plumbed directly into the mains waste with the adaptor supplied. Condensed water will drain away. A plumber will be required.

⚠ WARNING

The dryer should not be installed next to a refrigeration appliance.

- ▶ Do not install the Heat Pump dryer next to the high-temperature appliance like refrigerator, oven or stove etc. which can cause poor drying performance and programme duration, and adversely affect the proper functioning of the compressor.
- The Heat Pump dryer performs best at a room temperature of 23°

Note

- The damper in the door lock assembly and the packing for the rack assembly in the drum should be removed before use.
- For better drying performance, please keep the rear of product away from wall.
- Do not install the dryer where there is a risk of frost or dust.
 - The tumbles dryer may not be able to operate properly or may be damaged by freezing of condensed water in the pump and drain hose.

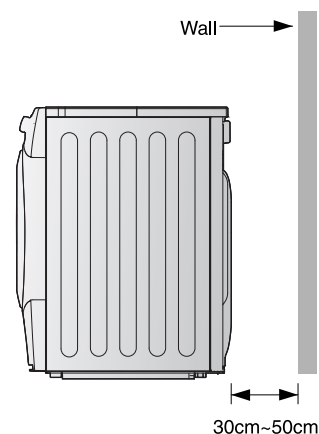

⚠ WARNING

Avoid installing the product around a heat source. The rear side of the dryer must be well ventilated. If not, this may cause problems.

Installation Instructions

● Level the Dryer

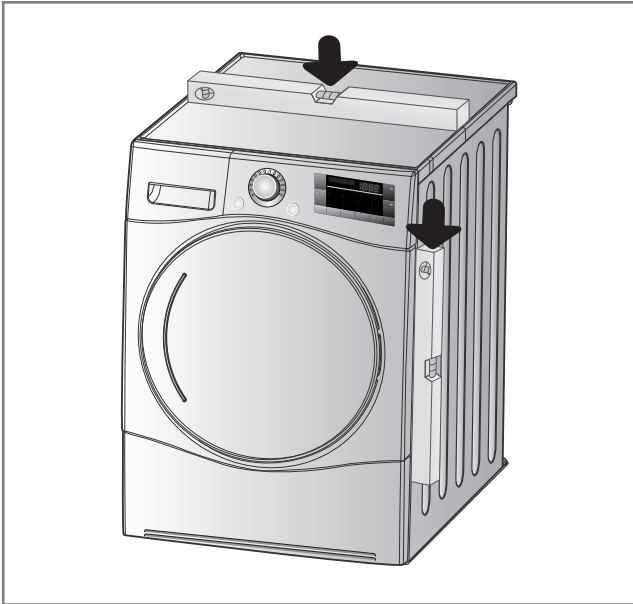

1. Levelling the dryer prevents unnecessary noise and vibration. Place your dryer on a solid, level floor.

Place the dryer in an area free from flammable materials, condensation and not liable to freezing.

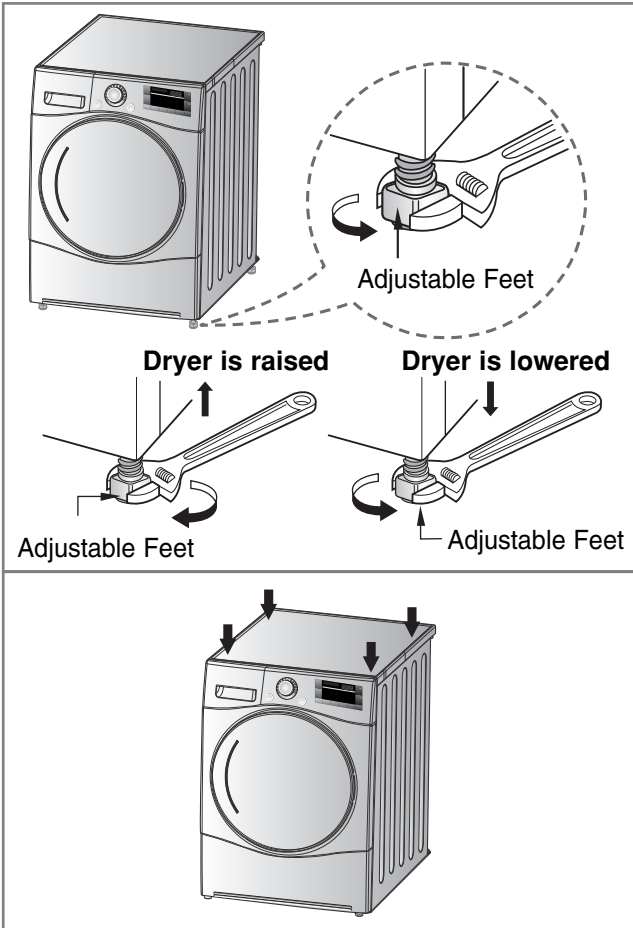

2. If the dryer is not properly level, adjust the front levelling feet as necessary.

Turn them clockwise to raise and counter-clockwise to lower until the dryer no longer wobbles, both front-to-back and side-to-side and corner-to-corner.

* *Diagonal Check*

When pushing down the edges of the machine, the machine should not move up and down at all (Please, check both directions).

If machine rocks when pushing the machine top plate diagonally, adjust the feet again.

Appearance & Design

Product Layout

■ RC9055AP3Z / BP3Z
RC9055AP2Z / BP2Z
RC9055APZ / BPZ

■ RC9055AP1Z / BP1Z

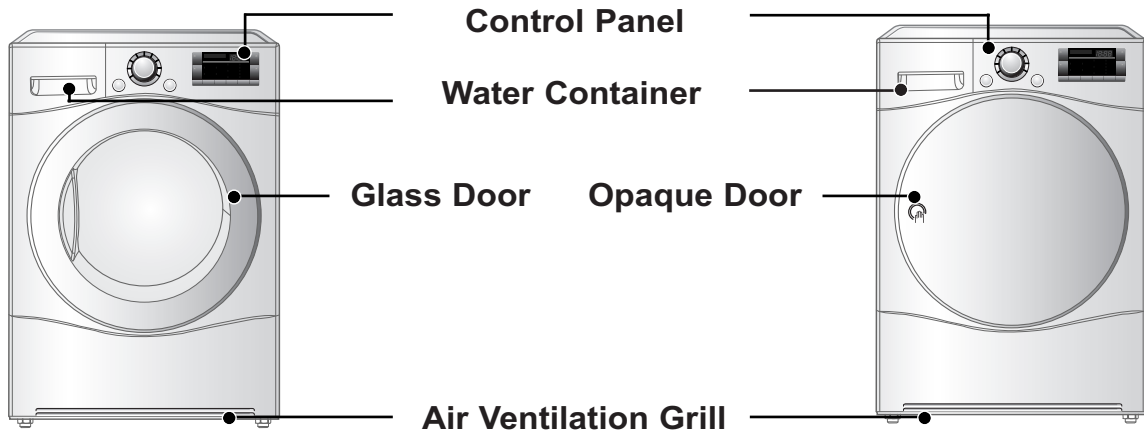

Control Panel

Smart Diagnosis™ function is available only for the products with a Smart Diagnosis™ mark.

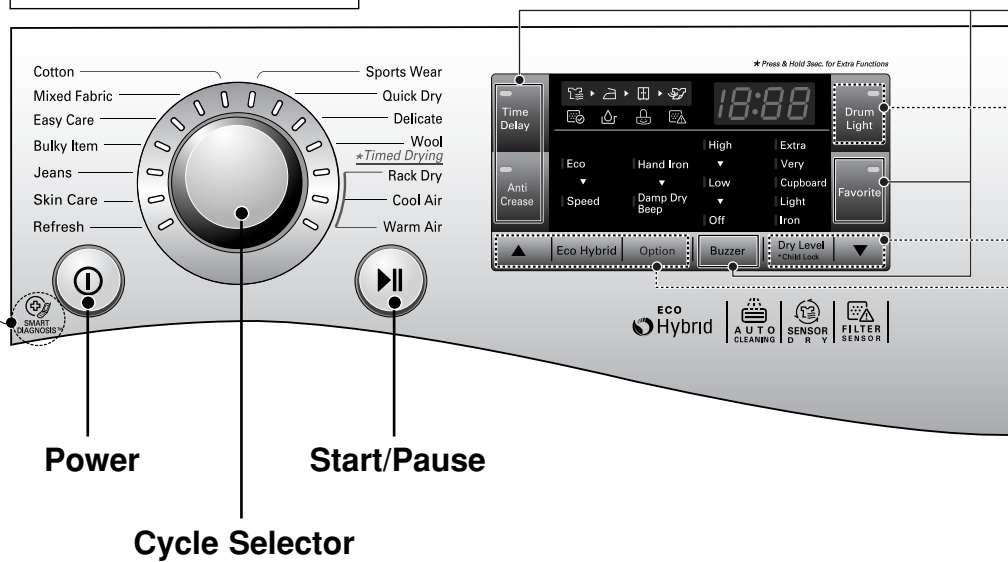

Options

- Time Delay
- Anti-Crease
- Favorite
- Buzzer

Additional programme

- ▲ Eco Hybrid
- Option
- Dry Level (*Child Lock)
- Drum Light
- ▼

Operating Your Dryer

Cycle Selection Table

		Sensor Dry Cycle	
Cycle	Laundry Type	Detail	Drying Level
Cotton	Towels, dressing gowns and bed linen	For thick and quilted fabrics	Extra
	Terry towels, tea towels, towels and bed linen	For thick and quilted fabrics that do not need to be ironed	Very
	Bath towels, tea towels, underwear and cotton socks	For fabrics that do not need to be ironed	Cupboard
	Sheets, pillowcase and towels	For fabrics that do not need to be ironed	Light
	Bed linen, table linen, towels, T-shirts, polo shirts and work clothes	For fabrics that need to be ironed	Iron
Mixed Fabric	Bed linen, table linen, tracksuits, anoraks and blankets	For thick and quilted fabrics that do not need to be ironed	Very
	Shirts and blouses	For fabrics that do not need to be ironed	Cupboard
	Trousers, dressers, skirts and blouses	For fabrics that need to be ironed	Iron
Easy care	Shirts, T-shirts, trousers, under-wear and socks	For polyamide, acrylic, and polyester that do not need to be ironed	Cupboard
	Shirts, T-shirts, under-wear, anoraks and socks	For polyamide, acrylic, polyester that do need to be ironed	Iron
Bulky Item	Bed clothes, sheets	For bulky items	-
Jeans	Jeans and colour fading garments.	For jeans which do not need to be ironed	-
Skin Care	T-shirts, pillowcase, and towels	For cotton fabrics which do not need to be ironed	-
Refresh (Refer to the Note)	Shirts and blouses	Odour removal of fabric (For fabrics in need of odour removal)	-
Sports Wear	Soccer kit and training wear	For polyester material	-
Quick Dry	Linen and towels, excluding fabrics applied to delicate, sports wear, bulky Item cycle.	For small loads of suitable fabrics with short drying times	-
Delicate	Silk, fine fabrics and lingerie	For fabrics that are heat-sensitive like synthetic fabrics	-
Wool	Wool	For wool fabrics	-
Timed Drying Cycle			
Rack Dry	Silk, wool, delicate lingerie	Refresh clothes without tumble drying	-
Cool Air	All fabrics that need refreshing	Tumbles without heat	-
Warm Air	Bath towels, bath robes, dishcloth and quilted fabrics made of acrylic	Small Items & damp clothing Everyday items suitable for heat drying	-

Note

When using the "Refresh" course, please spray cold or warm water on the fabric for a fresher result. (The recommend amount is 20cc of water per shirt.)

CAUTION

If the load is less than 1kg, please use the "Warm Air" Cycle in Timed Drying Cycle. Wool items should be dried using the "Wool" Cycle and heat-sensitive fabrics including silk, underwear and lingerie should be dried using the "Delicate" Cycle. Please comply with the recommended laundry load when you select your desired Cycle-found on page 19. Otherwise, your clothes may be damaged.

Operating Your Dryer

● Please read before using your LG dryer for the first time

- ※ After removing the packaging, please carry out the following checks to ensure the LG dryer is correctly installed and ready for use. (See installation instructions)
- 1. Check the dryer is well balanced by using a spirit level. If not, adjust the feet of the LG dryer until the machine is balanced.
- 2. Check the water container, filter, control panel and drum to make sure everything is in place.
- 3. Set the machine to dry for 5 minutes to warm up the drum.
- 4. Open the door between loads the first few times you use the machine to allow any odours from the interior of the LG dryer to disperse.

Note

The final part of a tumble dryer cycle occurs without heat (cool down cycle) to ensure that the items are left at a temperature to ensure that the items will not be damaged.

1. Turn the power on.

First, press the "Power" button. The indicator light above the button will become illuminated indicating that the machine is all set to run.

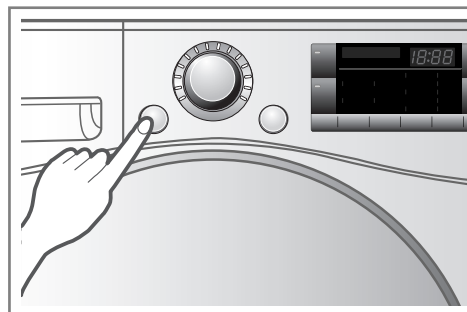

Turn the power on.

2. Open the door.

3. Check the filter and water container are clean.

The filter is inside the door rim or in the back of the door. It needs to be cleaned before and after drying.

Open the door and check the filter is clean. If not, please clean it referring to page 17. Also check if water container need to be emptied for optimum drying results.

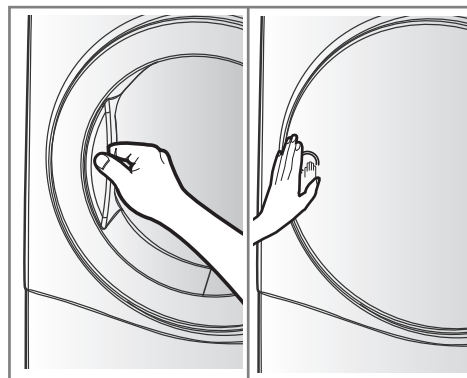

Open the Door.

4. Place laundry into the drum after sorting.

The clothes should be sorted by fabric type and dryness level and all the strings and belts of clothes should be well tied and fixed before being put into the drum.

Push the laundry to the back to keep it away from the door seal.

If not, the door seal and clothes may be damaged.

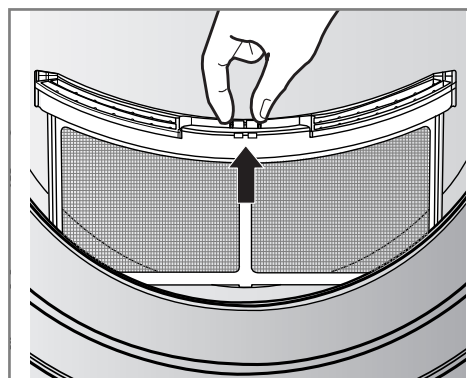

Check the filter.

⚠ CAUTION

Do not dry unwashed items in the tumble dryer.

Operating Your Dryer

5. Close the door.

Before you close the door, make sure fabrics are placed well inside and that foreign objects, especially flammable ones, are not caught around door.

⚠ CAUTION

- Be careful not to trap laundry between the door and rubber seal.

6. Select the drying cycle you want.

You can choose a cycle by turning the cycle selector knob until the required cycle is indicated. If you press Start/Pause button without choosing a cycle, the dryer will proceed with the Cupboard cycle. [Please refer to Cycle Selection table (page 11) for the detailed information.]

7. Press the start button.

You will hear drum rotating.

8. After the cycle has finished, open the door and remove the laundry.

⚠ CAUTION

Be careful! The drum inside could still be hot.

(Operation time varies depending on your cycle selection or options.)

Note

The final part of a tumble dryer cycle occurs without heat (cool down cycle) to ensure that the items are left at a temperature that will not damage them.

9. Clean the filter and empty water container.

The filter should be cleaned after each load.

10. Turn off the dryer.

Press the "Power" button.

⚠ CAUTION

- Take care if using a vacuum cleaner to clean the filter, as it is easily damaged and torn. If there is a residue build up on the filter, scrub the filter with a brush to remove.
- If you want to open the door while the dryer is operating, please press the Start/Pause button first, wait until the drum completely stops and then open the door.

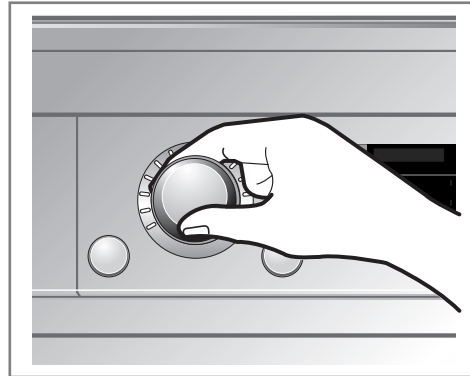

Select the desired cycle.

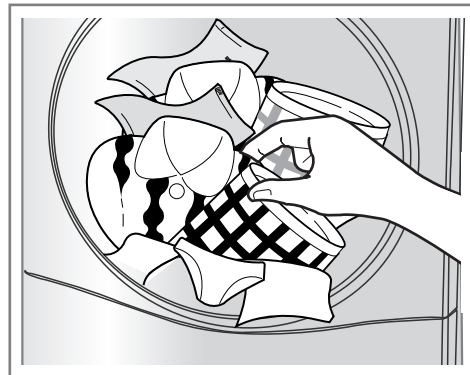

Take out the laundry.

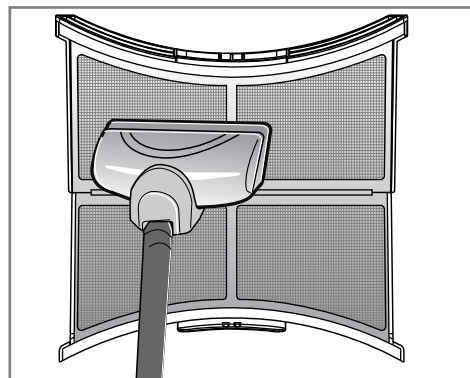

Clean the filter.
(Replace the filter if it is damaged.)

⚠ WARNING

Never stop a tumble dryer before the end of the drying cycle unless all items are quickly removed and spread out so that the heat is dissipated.

⚠ CAUTION

This dryer must not be used for purposes other than those for which it was designed.

Operating your dryer

Rack Dry

The dryer rack is placed inside the dryer like the picture. Remove and discard packing material before use.

The Rack Dry is designed for use with items that must be dried flat, without tumbling, including sweaters and delicate fabrics.

Note

Check the filter and remove any lint accumulated from items dried on the Rack. If preferred, set up Eco by pressing Eco Hybrid™ button.

To use the Rack Dry :

1. Open the door.
2. Do not remove the filter.
3. Place dryer rack over the bottom of the dryer door opening. Reset the Rack on the dryer back ledge. Push down on the frame front to secure over filter.
4. Place wet items on top of the rack. Allow space around items for air to circulate. The rack does not move, but the drum will rotate.
5. Close the door.
6. Turn power on and select Rack Dry.

1. Insert wire edge to the drum center.

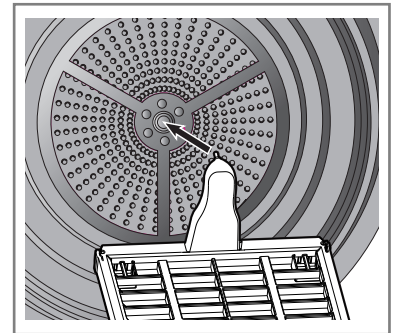

2. Place delicate fabrics or sports shoes.

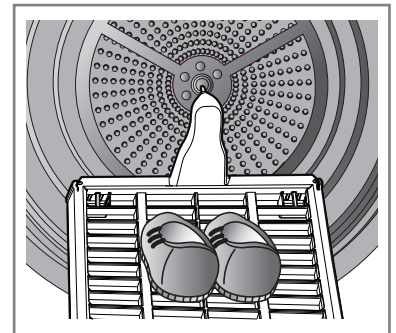

Additional Functions

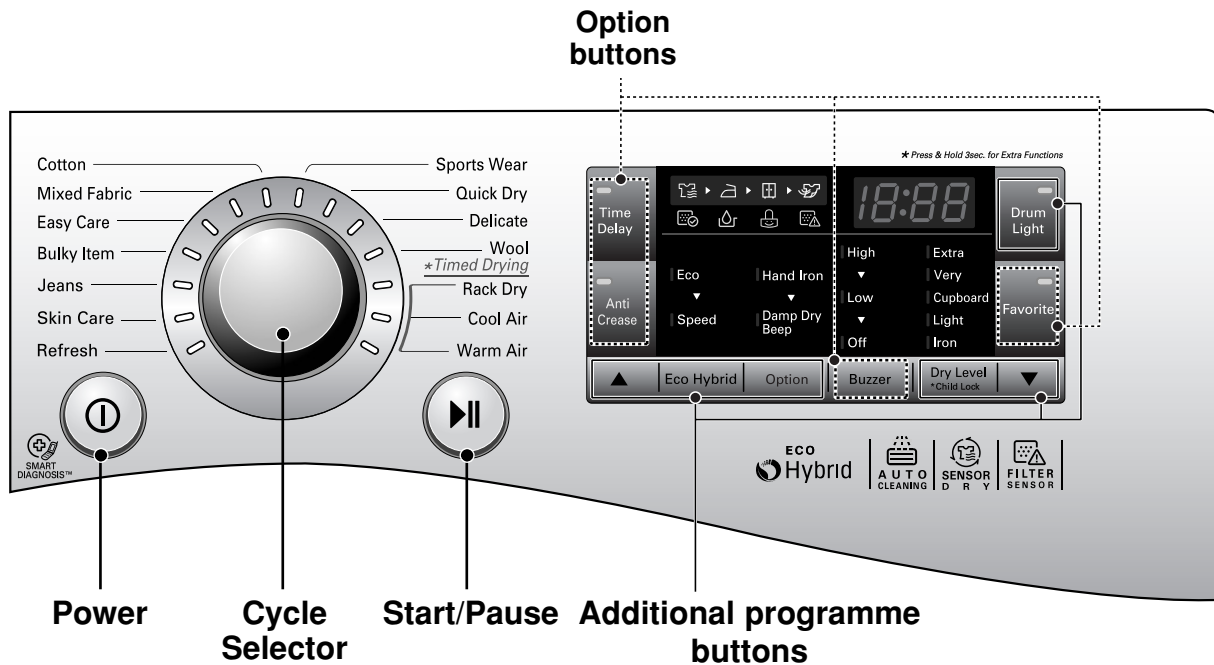

Power

- Press the Power button to turn power on and off.
- To cancel the Time Delay function, the power button should be pressed.

Cycle Selector

- Cycles are available according to the laundry type.
- The lamp will light up to indicate selected cycle.

Start/Pause

- This Start/Pause button is used to start dry cycle or pause the dry cycle.
- Press the Start/Pause button to stop the cycle temporarily.
- When in Pause, the power is turned off automatically after 4 minutes.

Additional Programme

- Use these buttons to select the desired options for the selected cycle.

Options

- This allows you to select additional options and will light when select.

Additional Functions

Time Delay

You can use the Time Delay option to delay the finishing time of drying cycle. Maximum Time Delay is 19 hours. Minimum Time Delay is 3 hours.

1. Turn the dryer on.
2. Select a cycle.
3. Set time delay hour(s) by press the “▲”, “▼” button.
4. Press Start/Pause button.

Anti Crease

The Anti Crease option prevents creases that are formed when the laundry is not unloaded promptly at the end of the drying cycle. When Anti Crease is selected, the dryer repeatedly runs and pauses, giving you 2 hours to unload the laundry. If the door is opened during the Anti-Crease option, the option is cancelled.

Favorite

Favorite option allows you to store a customized dry cycle for future use.

1. Turn the dryer on.
2. Select a cycle.
3. Select the option or additional programme. (Anti-Crease, Eco Hybrid™ etc.)
4. Press and hold Favorite option button for 3 seconds.

The Favorite option is now stored for future use. To reuse the stored cycle, select Favorite option and press the Start/Pause.

Drum Light

Whilst the dryer is running it is possible to see inside the drum if you select the Drum Light function.

- Light on : Door is opened.
- Light off : Door is closed.
Off automatically.

Eco Hybrid™

This additional program offers the option of either saving energy or time.

- Eco: energy saving option.
(Heat Pump only)
- Speed: time saving option.
(Heat Pump + Heater) You will see “ speed ” indication on the LED.

Option

Hand Iron

This function keeps the garments more moist than the standard Iron dry level.

Note

Cycle	Dry Level	Option
Cotton	Iron	Hand Iron is available
Mixed Fabric		
Easy Care		

Damp Dry Beep

This function lets you know when the clothes are ready for ironing.

Note

Cycle	Dry Level	Option
Cotton	Extra / Very Cupboard / Light	Damp Dry Beep is available
Mixed Fabric	Very / Cupboard	
Easy care	Cupboard	

Child Lock (&)



For the safety of your children, press Dry Level button for about 3 seconds.

You will see “  ” indication on the LED.

You can see “  ” sign on LED window.

- All controls except Child Lock and Power buttons will be disabled.
- Child Lock lasts after the end of cycle.

Note

For “Child Lock is off”, press Dry Level button for about 3 seconds.

Buzzer

This is an option to enable you to adjust volume of beeper sound.

Caring for Your Dryer

Caring for your Dryer is very Important

It's not difficult to care for your dryer but it is important that you do care for it to get the best out of it.

Clean Filter

Clean filter after each use and check it before each use. It should also be cleaned if the "Clean Filter" light becomes illuminated and the buzzer sounds whilst the dryer is in operation.

Cleaning or emptying the filter will reduce drying times and energy consumption and lengthen the dryer life.

⚠ CAUTION

- The lint trap has to be cleaned frequently, if applicable.
- Lint must not be allowed to accumulate around the tumble dryer.
- Filter must be cleaned after every cycle completes.

1. Open the door.

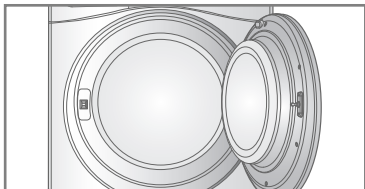

2. Pull the filter out.

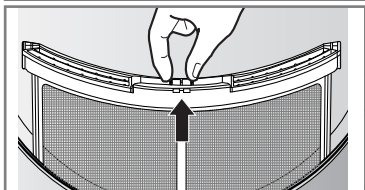

3. Clean the filter by using a vacuum cleaner or rinsing under the tap.

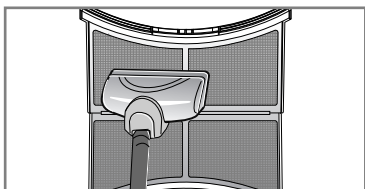

4. Replace the filter.
- Push the filter all the way down to avoid interference with the door.

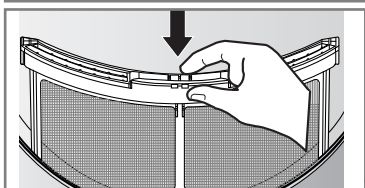

5. Close the door.

⚠ CAUTION

- After washing the filter, please dry thoroughly.
- Lint must not be left to accumulate in the dryer.

Note

If the filter is not in your dryer, you can not operate the dryer.



If "Clean Filter" symbol is displayed during the operation, clean the filter promptly.

1. Cool the dryer down and follow the above steps.
2. Press the Start/Pause button.

Empty Water Container

Condensed water is collected in the water container.

Empty the water container after every use.

Not doing so will affect the drying performance.

If the water container is full, the "Empty Water" lamp glows and the buzzer sounds while the dryer is operating. If this should occur, the water container needs to be emptied within the next hour.

1. Pull out the water container.

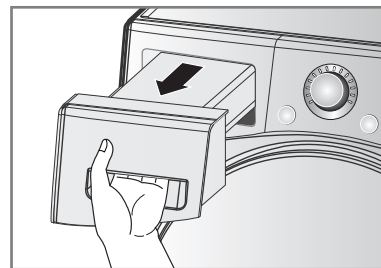

2. Empty water container in the sink.

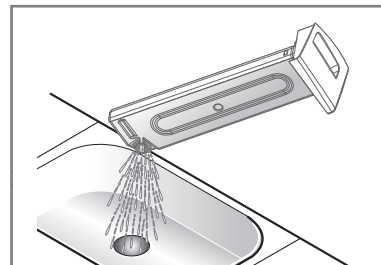

3. Push it back into the dryer.

4. Press the Start/Pause button.

Note

A high atmospheric temperature and a small room may both increase drying time as well as energy consumption.

⚠ WARNING

Do not drink the condensed water.

⚠ CAUTION

If the laundry is not spun at a high speed during washing, energy consumption and drying time will increase.

In some instances, LED window may display "💧" (Empty water symbol) and the dryer may stop because the water container is full.

Caring for Your Dryer

Ventilation Grill and Cool Air Inlet Grill

Vacuum the front ventilation grill 3-4 times a year to make sure there is no build up of lint or dirt that may cause improper air flow.

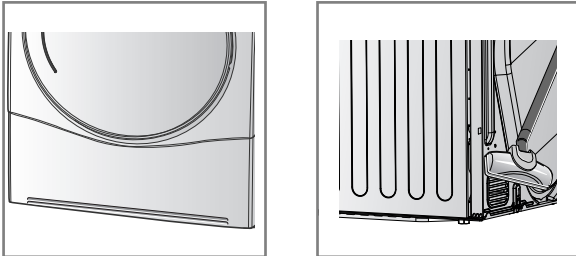

Note

- Warm air is exhausted through the ventilation grill.
- Adequate ventilation should be provided to avoid the back flow of gases into the room from units burning other fuels, such as open fires.

Condensed Water Drain-out

Normally, condensed water is pumped up to the water container where water is collected until manually emptied. Water can also be drained out directly to a mains drain, especially when the dryer is stacked on top of a washing machine. With a connecting kit for the mains drain hose, simply change the water path and re-route to the drainage facility as below:

1. Take connecting kit out.

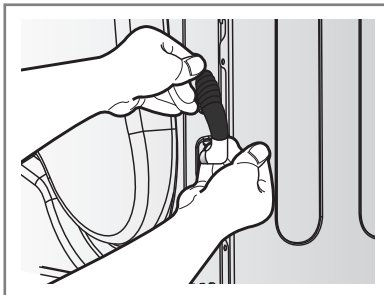

2. Separate water container hose from the kit.

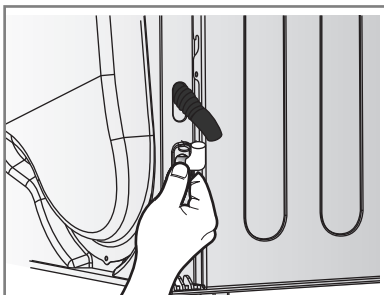

3. Connect drain hose to the kit.

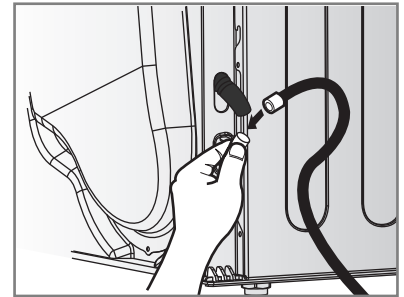

Moisture Sensor?

The device senses the moisture level of the laundry during operation, which means it must be cleaned regularly to remove any build-up of lime scale on the surface of the sensor. Wipe the sensors inside drum. (as illustrated)

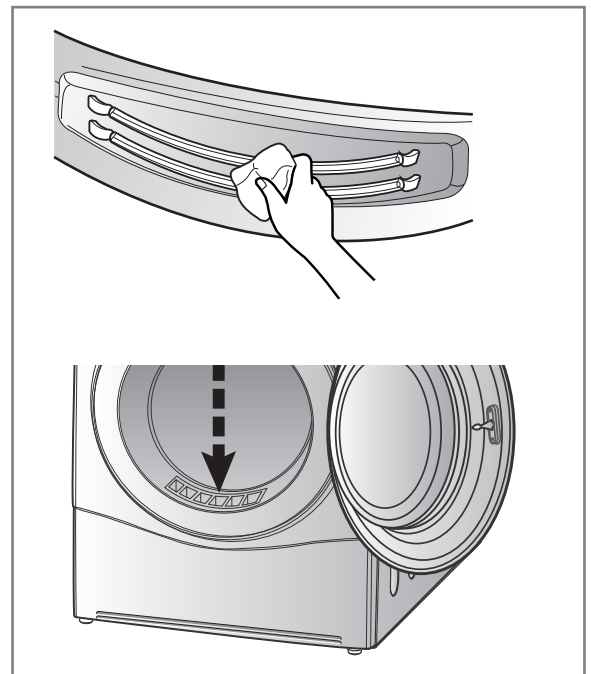

Additional Tips for Smart Use

Drying Guide

CYCLE		Capacity of dryer	Display Drying Time (Including Cooling Time)	
			Eco	Speed
Cotton	Extra	9 kg	200min	125min
	Very	9 kg	190min	120min
	Cupboard	9 kg	180min	115min
	Light	9 kg	170min	103min
	Iron	9 kg	160min	97min
Mixed Fabric	Very	4 kg	100min	53min
	Cupboard	4 kg	90min	48min
	Iron	4 kg	70min	41min
Easy Care	Cupboard	4 kg	70min	41min
	Iron	4 kg	60min	35min
Bulky Item		2 kg	120min	70min
Jeans		3 kg	110min	60min
Skin Care		4.5 kg	-	135min
Refresh		1.5 kg	-	39min
Sports Wear		2 kg	50min	-
Quick Dry		3 kg	-	50min
Delicate		1.5 kg	48min	-
Wool		1 kg	29min	

Woollens

Dry woollens on "wool" cycle. Be sure to follow fabric care label "symbols" first. Wool may not be completely dried from the cycle, so don't repeat drying. Pull woollens to their original shape and dry them flat.

Woven and Loopknit Materials

Some woven and loopknit materials may shrink, depending on quality.

Permanent Press and Synthetics

Do not overload your dryer. Take out permanent press items as soon as the dryer stops to reduce creases.

Baby Clothes and Night Gowns

Always check the manufacturer's instructions.

Rubber and Plastics

Do not dry any items made from or containing rubber or plastics such as:

- Aprons, Bibs and Chair Covers
- Curtains and Table Clothes
- Bathmats

Fiberglass















Do not dry fiberglass articles in your dryer. Glass particles left in the dryer could be picked up by your clothes the next time you use the dryer and irritate your skin.

Fabric Care Labels

Clothes have their own wash care labels, so drying according to the wash care label is recommended. Not only that, the laundry must be sorted according to size and type of fabric.

For the best drying performance and most efficient energy usage, do not overload the dryer.

Below are fabric care labels.

Symbols	Instructions
	Dry
	Tumble dry
	Permanent Press / Crease resistant
	Gentle / Delicate
	Do not tumble dry
	Do not dry
	High heating
	Medium heating
	Low heating
	No heat / air
	Line Dry / hang to dry
	Drip dry
	Dry flat
	In the shade

Additional Tips for Smart Use

Product Specification

LG AUTOMATIC CLOTHES DRYER		
Maker	LG Electronics	
Model	RC9055****	
Rated Capacity	kg	9kg
Dryer Type	Condenser Household Tumble Dryer	
Energy Efficiency Class	A++	
Annual Energy Consumption (AE _c)	kWh/yr	259
Automatic Tumble Dryer	Yes	
EU Ecolabel Award	No	
E _{dry}	kWh	2.20
E _{dry1/2}	kWh	1.15
Power Consumption at Full Load		
- . Off-mode (P _o)	W	0.4
- . Left-on mode (P _l)	W	0.4
Duration of Left-on mode	min	10
Standard Cotton Programme	Cotton Cupboard Eco	
Drying Time (T _t)	min	164
- . T _{dry}	min	214
- . T _{dry1/2}	min	127
Condensation Efficiency Class	A	
- . C _t	%	93
- . C _{dry}	%	93
- . C _{dry1/2}	%	93
Sound Power Level	dB	64

Programme	Dry Level	Option (Eco Hybrid™)	Load Content	Capacity	Estimated Performance			
					Energy Efficiency (kWh)	Drying Time (min)	Left-on mode (P _l) (W)	Off mode (P _o) (W)
Cotton	Cupboard	Eco	Cotton 100%	9kg	2.20	214	0.4	0.4
			Cotton 100%	4.5kg	1.15	127		
Mixed Fabric	Cupboard	Eco	Polyester 65%+Cotton35%	4kg	0.72	84	0.4	0.4
Easy Care	Cupboard	Speed	Polyester 65%+Cotton35%	4kg	1.14	75		

Note

- Tested in accordance with EN61121 and Directive 932/2012
- Set programme at "Cotton Cupboard Eco (Full & Half Load)" for test in accordance in conformity with EN61121 and Directive 932/2012
 - Standard Cotton programme : Cotton Cupboard + Eco Option (Default)
(This is the most efficient programmes in terms of the test conditions proposed by EN61121 and Directive 932/2012)
- Information about the 'standard cotton programme' and shall specify that it is suitable to dry normal wet cotton laundry and that it is the most efficient programme in terms of energy consumption for drying wet cotton laundry;
- The test results depend on room temperature, type and amount of load, water hardness and water inlet temperature.
- If product is installed as built under, it may cause performance degradation.

Additional Tips for Smart Use

● Spare Parts

Spare parts that are required under the terms of warranty are provided free of charge. If the warranty has expired then spare parts must be purchased from the service center.

● Disposal of the Dryer

It is requested that you dispose of your dryer safely to protect your children and others from possible injury.

The door, lid and other protruding parts must be removed and the power cord should be cut off before safe disposal.

● Service Contact

If there is a problem with your dryer, first consult the Trouble Shooting Guide. If you cannot find the error and you are unable to resolve the problem, please contact the Service Center.

A Customer Service representative will ask you the following questions:

1. Name, address and postcode.
2. Phone number.
3. Description of problem.
4. Model number and serial number of your dryer.
5. Date of Purchase.

● Accessory Parts

- Your dryer comes with accessories such as:

1. Condensing Drain Hose and Hose Holder (Purchased Separately)

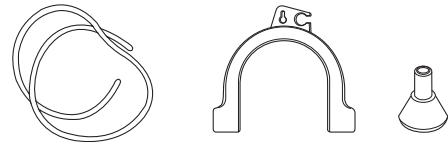

2. Dryer Rack

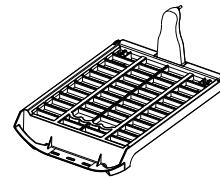

● Stacking Kit

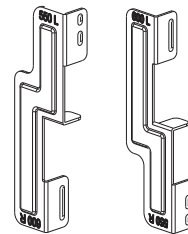

Holder : 2EA, Screw : 4EA

Purchased Separately



- The stacking kit can be used for washer top plate size 550mm and 600mm for both.

If stacking is needed, you must stack the dryer upon LG washing machine. A stacking kit is sold separately.

Troubleshooting Guide

Troubleshooting Tips

To save you time and money, the following page will help answer your questions before service call.

Questions	What to do
Dryer won't run	<ol style="list-style-type: none"> 1. Check dryer is plugged in. 2. Check "Start/Pause" button is pressed. 3. Check door is properly closed. 4. Check room temperature is below 5°C. 5. Check a fuse is blown or the circuit breaker is tripped and replace them. (Caution : electric dryers generally use two fuses or breakers) After emptying the water container and cleaning filter during operation, you must press Start/Pause button, then the dryer will operate again.
It takes a long time to dry	<ol style="list-style-type: none"> 1. Filter should be cleaned after each load. 2. Check water container is emptied. 3. Select correct cycle setting for fabric type. 4. Check air ventilation grille or rear vents of dryer are not obstructed. 5. Check clothes are not excessively wet. 6. Check the dryer is overloaded.
Dryer is operating but "Time Left" in the display doesn't change.	<p>This is not a malfunction. Drying time is estimated and will recalculate throughout the cycle as it senses the dryness of the load.</p>
	Check filter is clean.
Clothes are covered in fluff	<ol style="list-style-type: none"> 1. Check the filter is clean. 2. Check all the items in the dryer are clean. 3. Check all the laundry has been correctly sorted by fabric type. 4. Check the dryer is not overloaded. 5. Check if there are any paper, tissues or other degradable items amongst the laundry and remove.
The drying time is not consistent	The drying time for a load will vary depending on the heat setting, the size of the load, the type of fabrics, the wetness of the clothes and the condition of the filter.
Water is leaking	Check the water hose or drain hose is properly connected.
The clothes are creased	Check the dryer is not overloaded. Try a shorter drying time and remove items whilst they still retain a slight amount of moisture. Use the anti-crease option.
The garments have shrunk	To avoid shrinkage, please follow the care and use instructions for your garment, as some fabrics shrink naturally when washed and should not be placed in a dryer.
	Please check the filter is in the dryer.

Troubleshooting Guide

● Error Mode

- *dE* : The door must be closed and Start/Pause button must be pressed for re-operation. If error message continues to occur, unplug the power cord and call the service center for advice.

- *LE1, LE2, LE3, LE4, F1, OE*

: If error message continues to occur, unplug the power cord and call the service center for advice.

● Drum light does not work

- Contact the customer service center.

Troubleshooting Guide

Note

Smart Diagnosis™ function is available only for the products with a Smart Diagnosis™ mark. Should you have an analog phone, the Smart Diagnosis function may not operate.

● Using Smart Diagnosis™

- Only use this feature when instructed to do so by the call center. The transmission sounds similar to a fax machine, and so has no meaning except to the call center.
- Smart Diagnosis™ cannot be activated if the dryer does not power up. If this happens, then troubleshooting must be done without Smart Diagnosis™.

If you experience problems with your dryer, call the customer information center. Follow the call center agent's instructions, and do the following steps when requested:

1. Press the Power button to turn on the dryer. Do not press any other buttons or turn the cycle selector knob.

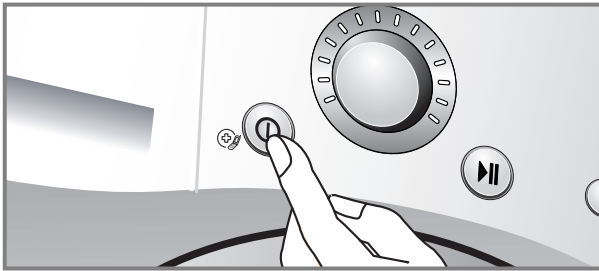

2. When instructed to do so by the call center, place the mouthpiece of your phone close to the "Smart Diagnosis™" icon and Power button.

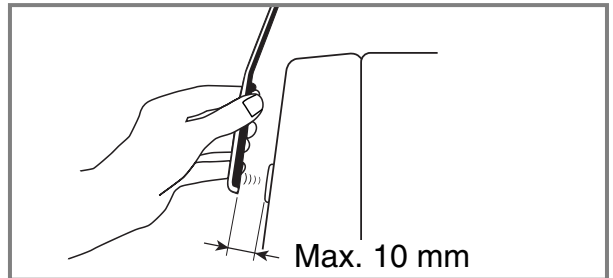
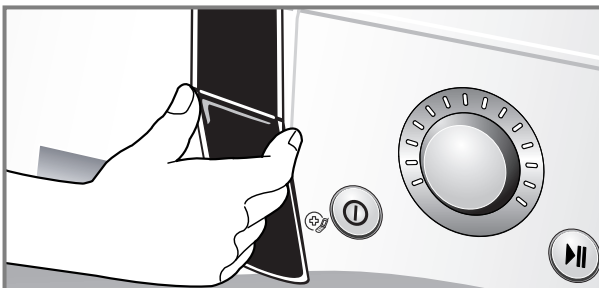
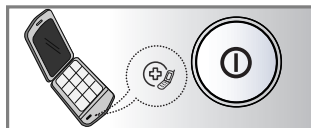

3. Press and hold the "▲ (More)" button for three seconds, while holding the mouthpiece of your phone close to the "Smart Diagnosis™" icon and Power button.
4. Keep the phone in place until the tone transmission has finished. This takes about 6 seconds, and the display will count down the time.
 - For best results, do not move the phone while the tones are being transmitted.
 - If the call center agent is not able to get an accurate recording of the data, you may be asked to try again.
 - Pressing the Power button during the transmission will shut off the Smart Diagnosis™.
5. Once the countdown is over and the tones have stopped, resume your conversation with the call center agent, who will then be able to assist you using the information transmitted for analysis at the call to customer information center.

Note

"Smart Diagnosis is a troubleshooting feature designed to assist, not replace, the traditional method of troubleshooting through service calls. The effectiveness of this feature depends upon various factors, including, but not limited to, the reception of the phone being used for transmission, any external noise that may be present during the transmission, and the acoustics of the room where the machine is located. LG does not guarantee that Smart Diagnosis would accurately troubleshoot any given issue."

T echnical Data

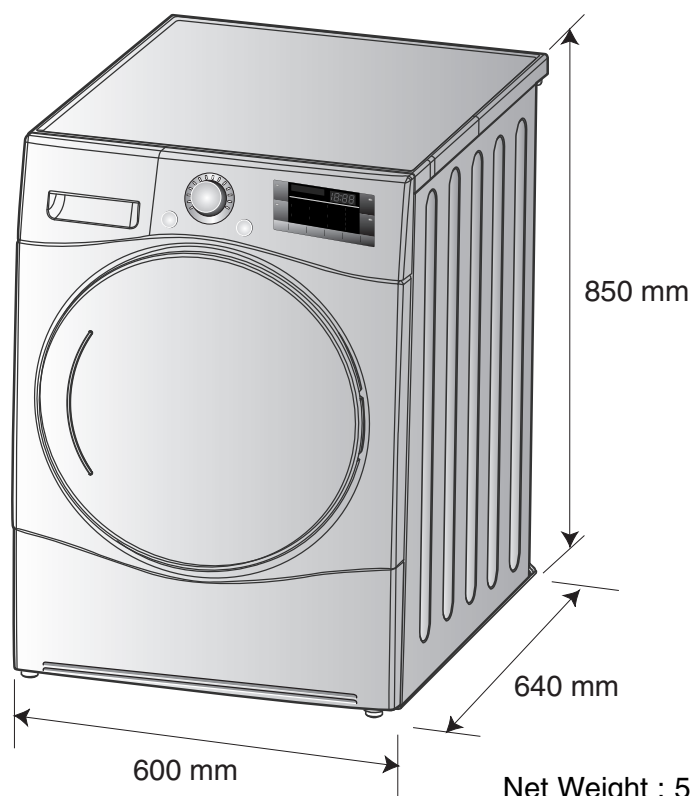

Net Weight : 55.9kg ,Opaque Door
57.4kg ,Glass(Cr) Door

● Electrical Requirements

Volts	Hertz	Watts
230 V	50 Hz	1800

Ensure you connect the dryer to the correct electricity voltage. The ratings plate on your dryer shows you what the voltage should be.

● Max. capacity : 9 kg

● Allowable temperature : 5 ~ 35°C

● Depth with door open : 1090mm

● Ventilation Requirement

Alcove or under counter	Closet
Ensure air flow of 112 cu.ft./min through dryer	Closet door must have 2 (louvered) openings, each having a minimum area of 60 sq. inches (387 sq.cm), located 3 inches (8 cm) from bottom and top of door.

Warranty

Disposal of your old appliance

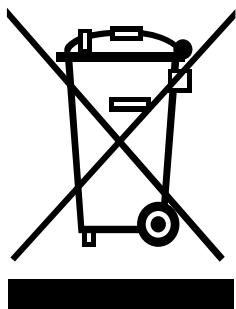

1. When this crossed-out wheeled bin symbol is attached to a product it means the product is covered by the European Directive 2002/96/EC.
 2. All electrical and electronic products should be disposed of separately from the municipal waste stream via designated collection facilities appointed by the government or the local authorities.
 3. The correct disposal of your old appliance will help prevent potential negative consequences for the environment and human health.
 4. For more detailed information about disposal of your old appliance, please contact your city office, waste disposal service or the shop where you purchased the product.
- Information of fluorinated greenhouse gases used as refrigerant of this dryer

Chemical name	Composition of Gases	Total GWP (kg CO ₂ -eq)
R - 134a	100% HFC - 134a	1300

Note

- When disposing of the appliance, cut off the mains cable, destroy the plug and disassemble the door to prevent children being trapped inside.

What is not covered.

- Service trips to your home to instruct you on the product.
If the product is connected to any voltage other than that shown on the rating plate.
- Faults caused by accidental damage, neglect, misuse or Acts of God.
If the fault is caused by reasons except for normal domestic use or use in accordance with the owner's manual.
- Faults caused by vermin, for example rats, mice etc.
- Noise or vibration that is considered normal, for example, water drain sound, spin sound or warning beeps.
- Correcting the installation for example, levelling the product, adjustment of drain.
- Normal maintenance recommended by the owner's manual.
- Removal of foreign objects/substances from the machine including the pump and inlet hose filter, for example, grit, nails, bra wires and buttons etc.
- Replacing fuses, correcting wiring or correcting plumbing.
- Correction of unauthorized repairs.
Incidental or consequential damage to personal property caused by possible defects with this appliance.
- If this product is used for commercial purposes its warranty is invalidated.
(Example: Public places such as public bathroom, lodging house, training center, dormitory)
- If the product is installed outside the normal service area, any cost of transportation involved in the repair of the products, or the replacement of a defective part, shall be borne by the owner.

Memo



For U.K. Customer

CUSTOMER SERVICE Tel : +44- (0) 844 847 5454

Fax. : +44- (0) 844 847 1413

LGEUK SERVICE WEB-SITE : <http://uk.lge.com>