

Introduction	Registration _____	4
	Important Safety Instruction _____	5
	Identification of Parts _____	9
Connection	Installation _____	10
	Connection _____	10
Operation	Control panel _____	12
	• Temperature control _____	13
	• Quick freeze _____	13
	• ECO Mode _____	14
	• Loose-fitting door alarm _____	14
	• Self-test _____	15
	Removal and installation of detachable glass shelf _____	15
	Removal and installation of drawer in refrigeration compartment _____	15
	Removal and installation of drawer in freezing compartment _____	16
	Ice preparation _____	16
CARE AND MAINTENANCE	Foodstuff storage _____	17
	Energy-Saving Method _____	17
	Cleaning _____	17
	General _____	18
	Refrigerator operation features _____	18
REHINGING OF DOORS	Rehinging of doors _____	19
Trouble Shooting	Trouble Shooting _____	21
	Disposal of your old appliance _____	22
SMART DIAGNOSIS	SMART DIAGNOSIS(Optional) _____	23

Registration

The model and serial number are found on the rear of this unit. This number is unique to this unit and not available to others. You should record requested information here and retain this guide as a permanent record of your purchase. Staple your receipt here.

Date of Purchase : _____

Dealer Purchased From : _____

Dealer Address : _____

Dealer Phone No. : _____

Model No. : _____

Serial No. : _____

Important Safety Instruction

▲ This is the safety alert symbol. It alerts you to safety messages that inform you of hazards that can kill or hurt you or others or cause damage to the product. All safety messages will be preceded by the safety alert symbol and the hazard signal word DANGER, WARNING, or CAUTION.

These words mean:

▲ WARNING!

You can be killed or seriously injured if you don't follow instructions.

▲ CAUTION!

Indicates an imminently hazardous situation which, minor or moderate injury, or product damage only.

▲ WARNING!

- Before it is used, this refrigerator must be properly installed and located in accordance with the installation instructions in this document.
- All safety messages will identify the hazard, tell you how to reduce the chance of injury, and tell you what can happen if the instructions are not followed.
- To reduce the risk of fire, electric shock, or injury to persons when using your product, basic safety precautions should be followed, including the following. Read all instructions before using this appliance.

When connecting the power:

The dedicated outlet should be used.

Using several devices at one outlet may cause fire.

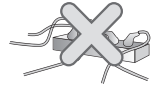

The electric leakage breaker may damage food and the dispenser may be leaked.

Water may be flown into or the plug may be damaged, which causes fire or electric shock.

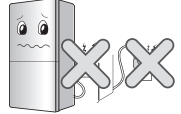

Do not allow the power cord bent or pressed by the heavy object to be damaged.

It may damage the power cord to cause fire or electric shock.



Do not extend or modify the length of the power plug.

It causes electric shock or fire by the electric damage of the power cord or others.

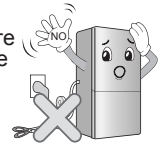

Do not pull out the cord or touch the power plug with wet hands.

It may cause electric shock or injury.



Remove water or dust from the power plug and insert it with the ends of the pins securely connected.

Dust, water or unstable connection may fire or electric shock.

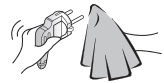

Make sure of grounding.

Consult a qualified electrician or service person if the grounding instructions are not completely understood, or if you have doubts on whether the appliance is properly grounded or not.

The incorrect grounding may cause breakdown and electric shock.

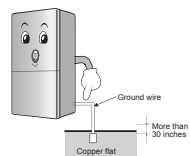

When the power cord or the power plug is damaged or the holes of the outlet are loosed, do not use them.

It may cause electric shock or short circuit to make fire.



When using the fridge-freezer:

Do not place the heavy object or the dangerous object (container with liquid) on the fridge-freezer.

It may be dropped to cause injury, fire or electric shock when opening or closing the door.



Do not cling to the door or the shelves of the door or the home bar of the freezer or the cool chamber.

It may make the fridge-freezer fall down or damage the hands. Especially, do not allow the children to do the above.



Do not install the fridge-freezer in the wet place or the place which water or rain splashes.

Deterioration of insulation of electric parts may cause electric leakage.



Do not use or store inflammable materials ether, benzene, alcohol, medicine, LP gas, spray or cosmetics near or in the fridge-freezer.

It may cause explosion or fire.



Do not put any living animal in the fridge-freezer.



Do not place the lit candle with in the fridge-freezer to deodorize. Do not use drier to dry the inside, nor light a candle to remove odor.

It may cause explosion or fire.



Do not store the medicine or the academic materials at the fridge-freezer.

When the material with the strict temperature control is stored, it may be deteriorated or it may make an unexpected reaction to cause any risk.

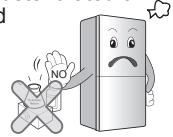

Use the submerged fridge-freezer after checking it.

It may cause electric shock or fire.

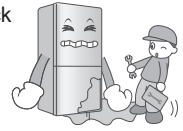

When gas is leaked, do not touch the fridge-freezer or the outlet and ventilate the room immediately.

The explosion by spark may cause fire or burn.

Because this fridge-freezer uses natural gas (isobutene, R600a) as the environment-friendly refrigerant, even a small amount (80~90g) is combustible. When the gas is leaked by the severe damage during delivering, installing or using the fridge-freezer, any spark may cause fire or burn.

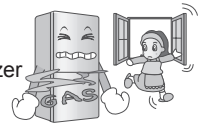

Do not spray water at the outside or the inside of the fridge-freezer or do not clean it with benzene or thinner.

Deterioration of insulation of electric parts may cause electric shock or fire.

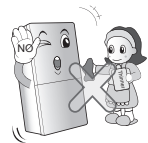

Carry the fridge-freezer with the handle bar at the bottom of the front and the top of the rear.

Otherwise, your hands may be slipped to cause injury.

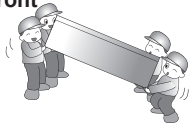

Because opening or closing the door of the fridge-freezer may cause injury to the person around it, be careful, please.

Opening or closing the door may cause feet or hands to be caught in the chink in door or the child to be get hurt by the corner.



When any strange smell or smoke is detected from the fridge-freezer, disconnect the power plug immediately and contact to the service center.

It may cause fire.



Do not allow any person except the qualified engineer to disassemble, repair or alter the fridge-freezer.

It may cause injury, electric shock or fire.

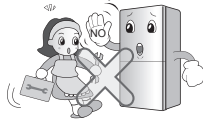

Do not use the fridge-freezer for non-domestic purpose (storing medicine or testing material, using at the ship, etc.).

It may cause an unexpected risk such as fire, electric shock, deterioration of stored material or chemical reaction.



When disposing the fridge-freezer, remove the packing materials from the door.

It may cause to lock out the child.



Install the fridge-freezer on the solid and level floor.

Installing it on the unstable place may cause death by falling down the fridge-freezer when opening or closing the door.



Do not insert the hands or the metal stick into the exit of cool air, the cover, the bottom of the fridge-freezer, the heatproof grill (exhaust hole) at the backside.

It may cause electric shock or injury.



Avoid the heating devices. Install in places away from the fire such as the place where flammable gas is leaked.

It may cause fire.

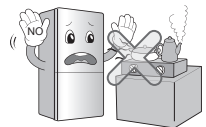

Do not insert the hands into the bottom of the fridge-freezer.

The iron plate of the bottom may cause injury.



Exclude ingress of fats and oils (including vegetable) onto plastic parts of the refrigerator.

This causes their spoilage and destruction.



⚠ CAUTION!

Violating this direction may cause injury or damage house or furniture. Always be careful, please.

When you want to dispose the fridge-freezer, contact to the down-block office.

When you want to dispose the large living waste such as electric home appliance and furniture, you'd better contact the local down-block office.

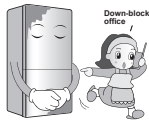

Do not touch food or containers at the freezer with wet hands.

It may cause frostbite.



Wait for 5 minutes or longer when reconnecting the plug.

It may cause the operation of the freezer to fail.



Pull out the power plug not by grasping the cord but the plug of its end.

It may cause electric shock or shortcircuit to fire.



Do not use the combustible spray near the fridge-freezer.

Do not store explosive substances such as aerosol cans with a flammable propellant in this appliance.

It may cause fire.



Unplug the power plug when cleaning, handling or replacing the interior lamp of the fridge-freezer.

It may cause electric shock or injury.

When replacing the interior lamp of the fridge-freezer, make sure that the rubber ring for preventing the electric spark within the socket is not taken off.



In case of thunder and lightning, or not in use for along period of time, detach the power plug.

There is a danger of electric shock or fire.



Do not place flower vase, cup, cosmetics, medicine or any container with water on the fridge-freezer.

It may cause fire, electric shock or injury by dropping down.



Upon opening or closing of the door, unstable objects may overturn, fall, and result in injury.

It may cause fire, electric shock or injury by dropping down.



The power outlet should be easily accessible for the event of necessary quick disconnection.

When one door of the refrigerator is closed abruptly, another door may open, since the refrigerator compartments are connected by air ducts.

⚠ CAUTION!

This appliance is intended to be used in household and similar applications such as staff kitchen areas in shops, offices and other working environments; farm houses and by clients in hotels, motels and other residential type environments; bed and breakfast type environments; catering and similar non-retail applications.

⚠ CAUTION!

This appliance is not intended for use by persons (including children) with reduced physical, sensory or mental capabilities, or lack of experience and knowledge, unless they have been given supervision or instruction concerning use of the appliance by a person responsible for their safety.

Children should be supervised to ensure that they do not play with the appliance.

⚠ WARNING!

Keep ventilation openings, in the appliance enclosure or in the built-in structure, clear of obstruction.

⚠ WARNING!

The refrigerant and insulation blowing gas used in the appliance require special disposal procedures. When disposal, please consult with service agent or a similarly qualified person.

⚠ WARNING!

Do not use mechanical devices or other means to accelerate the defrosting process, other than those recommended by the manufacturer.

⚠ WARNING!

Do not damage the refrigerant circuit.

⚠ WARNING!

Do not use electrical appliances inside the food storage compartments of the appliance, unless the type of the type recommended by the manufacturer.



This appliance contains a small amount of isobutane refrigerant (R600a), natural gas with high environmental compatibility, but it is also combustible. When transporting and installing the appliance, care should be taken to ensure that no parts of the refrigerating circuit are damaged. Refrigerant squirting out of the pipes could ignite or cause an eye injury. If a leak is detected, avoid any naked flames or potential sources of ignition and air the room in which the appliance is standing for several minutes.

In order to avoid the creation of a flammable gas air mixture if a leak in the refrigerating circuit occurs, the size of the room in which the appliance may be sited depends on the amount of refrigerant used. The room must be 1m² in size for every 8g of R600a refrigerant inside the appliance. The amount of refrigerant in your particular appliance is shown on the identification plate inside the appliance.

Never start up an appliance showing any signs of damage. If in doubt, consult your dealer.

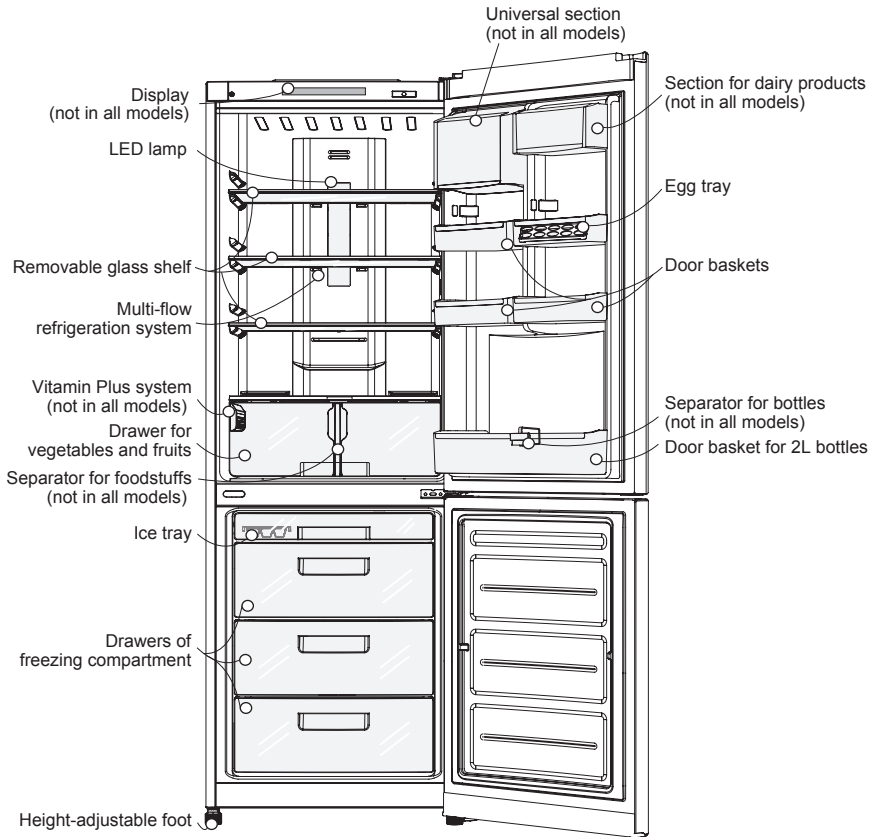

Identification of Parts



NOTE

Parts, features, and options vary by model. Your model may not include every option.

INSTALLATION

- Install the limit stops to the upper corners on the rear wall of the refrigerator as shown in Fig. 1. The stops are supplied in the door basket inside the refrigeration compartment;
- Choose the suitable place. Locate the refrigerator in a place convenient for its use;
- The refrigerator is not a built-in appliance. Free space not less than 5 cm should be provided from above, from its rear and side faces for air circulation and reduction of power consumption. Fig.2;
- Do not install the refrigerator near heat sources and in a zone exposed to direct sunlight or high humidity;
- Make sure that electrical voltage indicated in the manual meets the parameters of your mains;
- Do not remove the round stickers on the rear side of the refrigerator. They have a decorative function closing the fabrication holes;
- To exclude vibration, check the refrigerator installation using a level. If necessary, turn the adjustable feet to compensate irregularity of the floor.
To ensure better closing of the door, the refrigerator should be slightly inclined backwards. To turn the adjustable feet, slightly incline the refrigerator.
To raise the front part of the refrigerator, turn the adjustable feet counter-clockwise (); to lower it – turn them clockwise ();
- To ensure proper air circulation around the fridge -freezer, please maintain sufficient space on both the sides as well as top and maintain at least 2 inches (5cm) from the rear wall.

- Before use, carefully wash the refrigerator;
- Install the removable parts, such as ice tray, etc. to the appropriate places. It is necessary to prevent possible damages during transportation;
- Insert the power cord plug to the power outlet. Do not power other electric appliance from the same outlet.

CONNECTION

After first installation of the refrigerator, let it work for 2-3 hours for stabilization of the operating temperature inside and only then fill the refrigerator with fresh or frozen foodstuffs. After disconnection of the refrigerator from the mains, wait at least 5 minutes to switch on it again. Now, the refrigerator is ready for service.

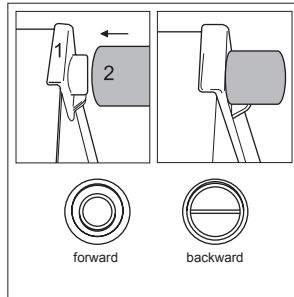

Figure 1. Installation of limit stops

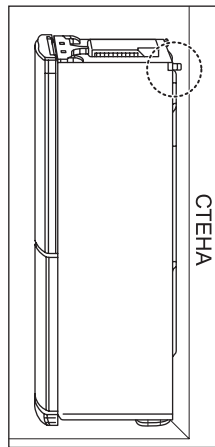

Figure 2. Installation of refrigerator to wall

NOTE

The limit stops are located in the door basket of the refrigeration compartment. They should be installed to get higher operational efficiency of the refrigerator.

CONTROL PANEL

External light-emitting-diode (LED) display

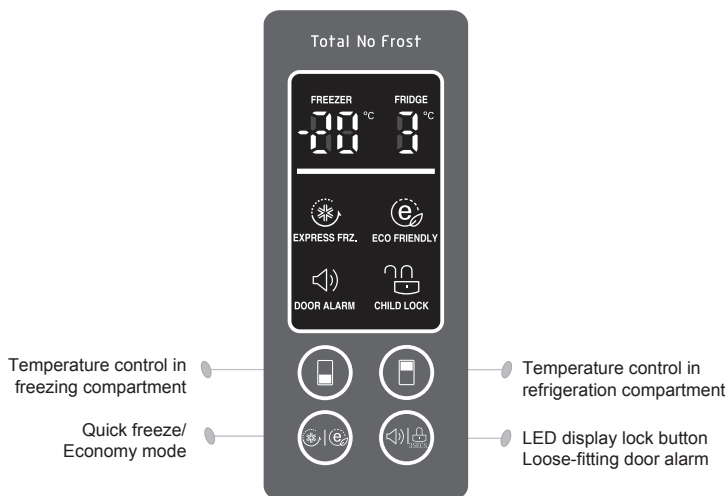

Internal display



TEMPERATURE CONTROL

The initial temperature in the refrigeration and freezing compartments is 3 °C and -20 °C, respectively.

If you wish, you can change it pushing the temperature control button of the appropriate compartment.

External LED display



Internal LED display

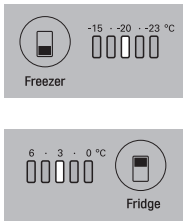

NOTE

Temperature indicated on the LED display is a target value, since actual temperature inside the refrigerator varies depending on intensity of exposure to external factors, such as temperature of placed foodstuffs and door opening frequency. After switching on, the refrigerator reaches the set mode for 2-3 days.

QUICK FREEZE

It is used, if it is necessary to quickly freeze foodstuffs.

Push once the "Quick freeze/Economy mode" button (on the external display) or "Quick freeze" button (on the internal display). The "QUICK FREEZE" lamp will light up and quick freezing will be started. Quick freeze takes about 24 hours.

Upon completion of this operation, the refrigerator automatically goes to the previous state (earlier set temperature mode).

If you wish to stop the quick freeze operation, push again twice the "Quick freeze/Economy mode" button (on the external display) or once the "Quick freeze" button (on the internal display). The lamp will extinguish, the quick freeze operation will be stopped, and the refrigerator will return to the previous state (previous temperature mode).

External LED display



Internal LED display



ECO MODE

It activates the power saving mode, which is convenient in the event of your long departure. It allows you to reduce power consumption. Push twice the "Quick freeze/Economy mode" button (on the external display) or once the "Economy mode" button (on the internal display). The lamp will light up (ECO MODE). Repeated pushing of the button deactivates this function.

External LED display



Internal LED display



To activate the "ECO MODE", push the "Quick freeze/Economy mode" button. Third pushing of the button deactivates both modes and the refrigerator returns to the previous temperature mode.

NOTE

When the "ECO MODE" is activated, other buttons are inoperative. Push the "ECO MODE" button to return the appliance to the previous temperature mode.

NOTE

For power saving, the external display is switched to the energy conservation mode – backlighting of all indicators except for "LOCK" extinguishes.

LOOSE-FITTING DOOR ALARM

- If the refrigerator door is opened for some time (30 sec), the alarm is activated;
- You can enable and disable the loose-fitting door alarm shortly pushing the "ALARM" button (not in all models);
- If the alarm continues to sound even after closure of the door, contact the service center.

External LED display



"LOCK" (for models with LED display)

- When the "LOCK" button is activated, other buttons are inoperative;
- To lock/unlock the refrigerator display, push the "LOCK" button and hold it for 3 seconds.



NOTE

In the event of power cutoff, the mode settings are kept.

SELF-TEST

The display has a self-test function. If the refrigerator has a failure, the buttons become inoperative and the indicator shows the error code. In this case, do not switch off power and immediately contact the local service center. If you switch off the refrigerator, a service engineer may need much time to find the faulty element.

REMOVAL AND INSTALLATION OF DETACHABLE GLASS SHELF

To remove a shelf from the refrigerator, first slightly raise it (1) and then pull (2). Improper removal may result in damage of internal parts in the refrigerator.

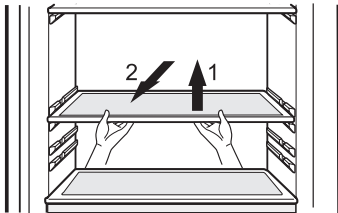

To install a shelf to the refrigerator, proceed in the same way: first raise the front edge of the shelf (3) and then push it to the refrigerator (4). Improper installation may result in damage of internal parts in the refrigerator.

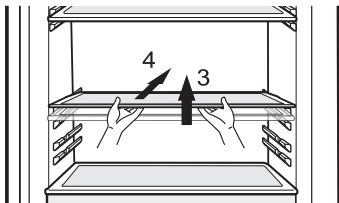

REMOVAL AND INSTALLATION OF DRAWER IN REFRIGERATION COMPARTMENT

To remove the lower drawer from the refrigerator compartment, proceed as follows:

- Remove the lower basket from the door raising the basket;
- Pull the drawer all the way out raising it by the front part and pulling;

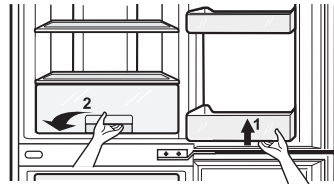

- Raise the drawer cover by the front part and pull to remove it;

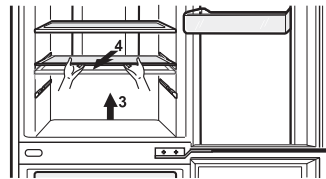

- To install the drawer back, proceed in the reverse sequence.

▲ CAUTION!

At that, you should take care to exclude slant. Improper removal and installation may result in damage of internal parts in the refrigerator.

Two stars section ()** (Applicable to some models only)

- Two stars section means the space stored at $-12^{\circ}\text{C} \sim -18^{\circ}\text{C}$
- Freezer foods for short-terms storage.

NOTE

The guarantee does not cover mechanical damages (cracks, shears, dents, traces of enclosure opening, etc.) caused by violation of the refrigerator storage, transportation, operation, and maintenance rules, application of excessive force.

REMOVAL AND INSTALLATION OF DRAWERS IN FREEZING COMPARTMENT

When a large quantity of foodstuffs is stored in the freezing compartment, you can remove the middle drawer from the appliance and store foodstuffs immediately on foodstuffs placed to the lower drawer.

To remove any drawer of the freezing compartment, proceed as follows:

1. Pull the drawer all the way out;
2. Raise it by the front part and pull.

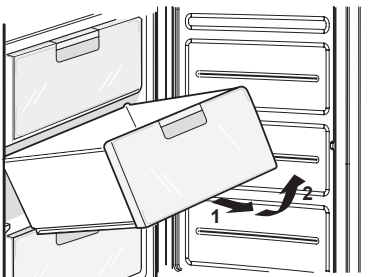

To install any drawer back to the freezing compartment, proceed in the reverse sequence:

1. Place the drawer onto the guides at an angle 45°;
2. Lower the front part of the drawer in parallel to the guides;
3. Push the drawer all the way in.

At that, you should take care to exclude slant.

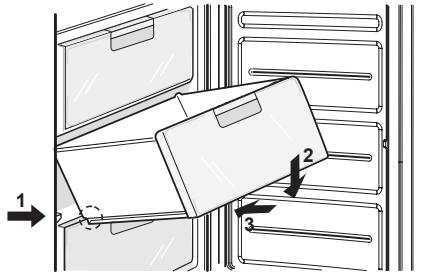

⚠ CAUTION!

Do not apply excessive force to remove the drawers and shelves – this may result in damage of the refrigerator.

ICE PREPARATION

Fill the ice tray with water and place it to the freezing compartment.



If ice cubes are required as soon as possible, activate the "QUICK FREEZE" function.

To remove ice cubes, hold the tray on ends and slightly bend it.



⚠ CAUTION!

Connect to potable water supply only.

ADVICE

To easily remove cubes, water the tray in advance.

FOODSTUFF STORAGE

- Do not store food which goes bad easily at low temperature, such as banana, and melon.
- Allow hot food to cool prior to storing. Placing hot food in the fridge-freezer could spoil other food, and lead to higher electric bills.
- When storing the food, use a container with a lid. This prevents moisture from evaporating, and helps food to keep its taste and nutrients.
- Do not block air vents with food. Smooth circulation of cold air keeps fridge-freezer temperature even.
- Do not open the door frequently. Opening the door lets warm air enter the fridge-freezer, and cause temperature to rise.
- To adjust the temperature control easily, do not store food near the temperature control dial.
- Never keep too many foods in door rack, as this may stop the door from fully closing.
- Do not store bottles in the freezer compartment - they may break when frozen.
- Do not refreeze food that has been thawed. This causes loss of taste and nutrition.
- If it is necessary to quickly freeze fresh foodstuffs, place them to the lower drawer of the freezing compartment and push the "QUICK FREEZE" button;
- Frozen foodstuffs should be stored packed (in polyethylene film, aluminum foil, etc.) in the freezing compartment;
- Volume of the upper drawer in the freezing compartment is the "two stars" section. Temperature inside this section does not rise above -12°C. This should be taken into account for storage of foodstuffs.

Energy-Saving Method

- Install the fridge in a shady, cool and well-ventilated place.
- Do not open and close the door frequently if not necessary.

- Please do not keep the door open for a long time, close door in the shortest time
- Allow hot food to cool prior to storing.
- Too much food are not advised to be put in. Enough space should be kept for cool air circulating freely.
- Do not set the temperature of refrigerator lower than needed. Do not put the food near the temperature sensor.
- Food need't store is not advised to be put in.
- Place the deep-frozen food for thawing intorefrigerator; they can be used for cooling the refrigerator.
(Applicable to some models only)
- Do not block air vents with food.
(Applicable to some models only)

CLEANING

1. Before cleaning, make sure that power supply is switched off;
2. Outside and inside, the refrigerator should be washed with a clean napkin wetted in warm water with a liquid detergent. Then wipe dry with a dry napkin;
3. After cleaning, make sure that the power cord is not damaged. Then tightly insert the plug to the power outlet.

⚠ CAUTION!

1. It is prohibited to use abrasive materials, gasoline, benzene, solvents, hydrochloride, hot water, hard brushes, etc., which may damage the refrigerator surface.
2. For products with a stainless steel exterior, use a clean sponge or soft cloth and a mildDetergent in warm water. Do not use abrasive or harsh cleaners. Dry thoroughly with a Soft cloth. Do not use appliance wax, bleach, or other products containing chlorine on stainless steel.

GENERAL

Electric power failure.

- An interruption in electric power supply for 1-2 hours will not harm the stored foodstuffs. Try to less frequently open and close the refrigerator door during this period.

DURING MOVE:

- Remove all foodstuffs and other objects from the refrigerator. Firmly secure the internal detachable parts (shelves, drawers, door baskets);
- To avoid damage of the floor and adjustable feet of the refrigerator, turn them counter-clockwise before transportation;
- The refrigerator should be firmly secured in the truck to prevent its hits and falling inside the truck during transportation;
- The refrigerator should be transported in vertical position in a covered vehicle. The original package should not be damaged during transportation;
- During loading and unloading, the refrigerator should be protected against hits.

BEFORE SWITCHING ON:

- If the refrigerator is transported in cold season, unpack the refrigerator in a warm room and do not switch on it for at least 12 hours.

⚠ CAUTION!

Do not move or incline the refrigerator during its operation.
Noise may occur in the compressor.
This feature does not affect operability of the compressor.

REFRIGERATOR OPERATION FEATURES

Cracking noise may be heard due to thermal deformations of the refrigerator components. Typical sounds from activation of the thermostatic controller and compressor are normal sounds occurring during operation of electric equipment in the appliance.

The refrigerant circulating inside the refrigeration system may calmly gurgle, even if the compressor is idle.

Do not worry, this is absolutely normal.

The following sounds may be heard during operation of the refrigerator:

- Clicks from actuation of the temperature sensor/switch;
- Murmur of the refrigerant circulating in tubes of the refrigeration system;
- Slight cracking noise from thermal deformations of materials.

These sounds are not associated with any defect and they have a functional aspect.

ANTI-CONDENSATION TUBE:

- The anti-condensation tube is laid inside the enclosure around the front face of the refrigerator to exclude moisture condensation;
- The refrigerator may greatly heat up in these places, especially immediately after switching on for the first time or at high ambient temperature.

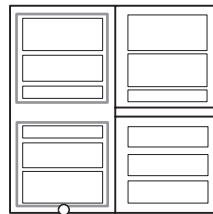

Anti-condensation tube

REHINGING OF DOORS

The refrigerator is designed so that the doors can be opened right or left depending on the layout of your kitchen.

⚠ CAUTION!

1. Prior to hinging the door to the opposite side, first of all unload the refrigerator from foodstuffs and remove all unsecured accessories (shelves and drawers) from it.
2. To tighten and loose bolts, use a socket wrench or a box wrench for 10 mm.
3. Do not lay the refrigerator onto the floor.
4. Take care to exclude dropping of the door in the process of disassembly or assembly.

1. Unscrew the screw ② of the upper hinge cover ① and remove the hinge cover ① and disconnect the connection cable ⑤ (only for models with an ④ external display). Unscrew the bolts ③ fixing the upper hinge ④ and carefully remove the door from the middle hinge ⑩. Remove the blank ⑧.

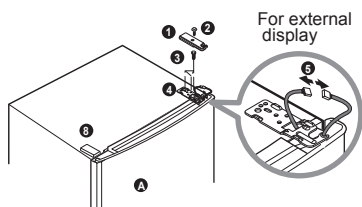

2. Remove the upper door cover ⑦ (only for models with an external display), pull out the cable ⑤ and install it to the hole on the opposite side of the door. Install the upper door cover ⑦ into place.

Remove the plastic bushing ⑥ from the door of the refrigeration compartment ⑤. Unscrew the screw ⑩ located above the door of the refrigerator and move the door stop ⑨ to the opposite side. Tighten the screw ⑩. Move the plastic bushings ⑥ and ⑭ (only for models with an internal display) to the opposite side.

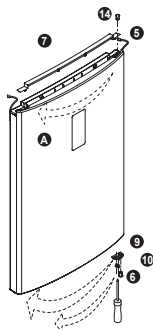

3. (Only for models with an external display). Using a flat screwdriver, push and separate the caps ⑫ from the front panel ⑪ and unscrew the screws ⑬, remove the panel ⑪, move the cable ⑮ to the opposite side. After installation of the panel ⑪ into place, tighten the screws ⑬ and close their heads with the caps ⑫.

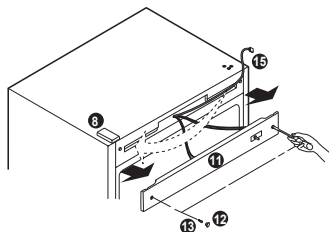

4. Unscrew the bolts ⑯ of the middle hinge, remove the middle hinge and raise the door of the freezing compartment ⑤ to remove the door. Remove the blank ⑰ and install it instead of the removed middle hinge ⑱.

Unscrew the dowel 22 of the lower hinge 23 turning it counter-clockwise and screw the dowel into the opposite hole. Unscrew the bolts 24 fixing the lower hinge 23 and bolt 25 on the refrigerator enclosure. Unscrew the screw 10 on the lower part of the door fixing the door closer 29 of the freezing compartment B. Unscrew the screw 10 on the lower part of the door fixing the door stop 9 of the freezing compartment B, move the stop 9 to the opposite side into the dedicated place and fix it. Rehinge the closer 29 to the opposite side into the dedicated place and fix it. Move the upper cap 26 to the opposite side.

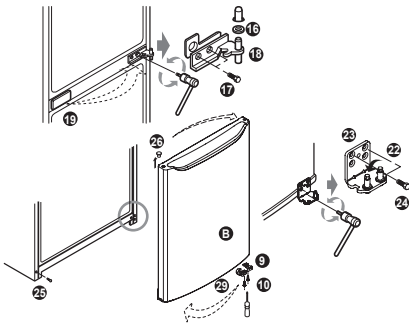

5. Attach the removed lower hinge 23 to the holes located on the opposite side of the enclosure and fix the hinge with the bolts 24. Tighten the screw 25 in the enclosure on the opposite side. Install the door of the freezing compartment B onto the lower hinge dowel 23. Unfold the removed middle hinge 18 with its axis out and fix the hinge with the bolts 17 (tighten the bolts carefully to exclude scratching of the door). Install the washer 16 onto the middle hinge 18.

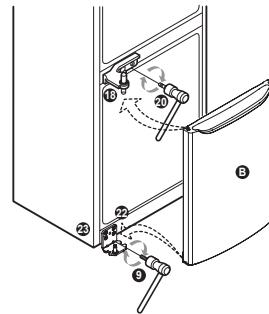

6. Install the door of the refrigeration compartment A aligning the hole in the lower part of the door and middle hinge dowel 18. Then install the upper hinge 27 supplied in the refrigerator package placing the dowel into the appropriate upper hole in the door of the refrigeration compartment A. Connect the cable connectors 5 (only for models with an external display). Fix the upper hinge 27 using the bolts 3. Install the left cover of the upper hinge 25 and fix it with the screw 2. Install the blank 28 supplied in the refrigerator package.

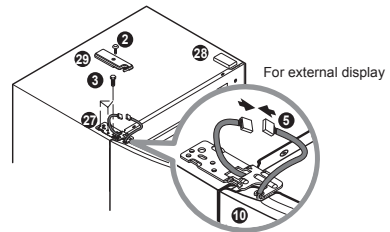

NOTE

Reversing the doors is not covered by the warranty.

Before calling for service, check this list.
It may save you both time and expense.

This list includes common occurrences that are not the result of defective workmanship or materials in this appliance.

Problem	Possible Causes
Fridge-Freezer does not operate	<ul style="list-style-type: none"> • Power plug may be unplugged from the electric outlet. Plug it in securely. • House fuse has blown or circuit breaker has tripped. Check and/or replace fuse and reset circuit breaker. • Power cut. Check house lights.
Fridge or Freezer Compartment Temperature too warm	<ul style="list-style-type: none"> • Temperature control not set on proper position. Refer to Temperature Control section. • Appliance is placed close to heat source. • Warm weather-frequent door openings. • Door left open for a long time. • Package holding door open or blocking air duct in freezer compartment.
Vibration or Rattling or Abnormal Noise	<ul style="list-style-type: none"> • The floor on which the fridge-freezer is installed may be uneven or the fridge-freezer may be unstable. Make it even by rotating the leveling screw. • Unnecessary objects placed in the back side of the fridge-freezer.
Frost or Ice Crystals on frozen Food	<ul style="list-style-type: none"> • Door may have been left ajar or package holding door open. • Too frequent or too long door openings. • Frost within package is normal.
Moisture forms on Cabinet Surface	<ul style="list-style-type: none"> • This phenomenon is likely to occur in a wet space. Wipe it with a dry towel.
Moisture collects inside	<ul style="list-style-type: none"> • Too frequent or too long door openings. • In humid weather, air carries moisture into fridge when doors are opened.

Problem	Possible Causes
Fridge has odor	<ul style="list-style-type: none"> • Foods with strong odors should be tightly covered or wrapped. • Check for spoiled food. • Interior needs cleaning. Refer to CLEANING section
Door not closing properly	<ul style="list-style-type: none"> • Food package is keeping door open. Move packages that keep door from closing. • Fridge-freezer is not level. Adjust the leveling screws. • The floor on which the fridge-freezer is installed may be uneven or the fridge-freezer may be unstable. Slightly raise the front side with the leveling screw.
Interior light does not work	<ul style="list-style-type: none"> • No power at outlet. • Light lamp needs replacing. Refer to the Lamp Replacement section

Disposal of your old appliance



1. When this crossed-out wheeled bin symbol is attached to a product it means the product is covered by the European Directive 2002/96/EC.
2. All electrical and electronic products should be disposed of separately from the municipal waste stream via designated collection facilities appointed by the government or the local authorities.
3. The correct disposal of your old appliance will help prevent potential negative consequences for the environment and human health.
4. For more detailed information about disposal of your old appliance, please contact your city office, waste disposal service or the shop where you purchased the product.

SMART DIAGNOSIS

Should you experience any problems with your refrigerator, it has the capability of transmitting data via your telephone to the LG service center. This gives you the capability of speaking directly to our trained specialists. The specialist records the data transmitted from your machine and uses it to analyze the issue, providing a fast and effective diagnosis.

If you experience problems with your refrigerator, call the phone No. of LG Customer Information Center. Only use the Smart Diagnosis feature when instructed to do so by the LG call center agent. The transmission sounds that you will hear are normal and sound similar to a fax machine.

Smart Diagnosis cannot be activated unless your refrigerator is connected to power. If your refrigerator is unable to turn on, then troubleshooting must be done without using Smart Diagnosis.

Using Smart Diagnosis

First, call the phone No. of LG Customer Information Center. Only use the Smart Diagnosis feature when instructed to do so by the LG call center agent.

- 1 Lock the display. (Option)
To lock the display, press and hold the Lock button for three seconds. (If the display has been locked for over five minutes, you must deactivate the lock and then reactivate it.)



- 2 Open the refrigerator door.

- 3 Hold the mouthpiece of your phone in front of the speaker that is located on the right hinge of the refrigerator door, when instructed to do so by the call center.

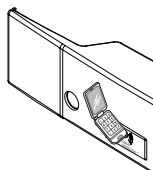

- 4 Press and hold the Freezer Temperature button for three seconds while continuing to hold your phone to the speaker.



- 5 After you hear three beeps, release the Freezer Temperature button.
- 6 Keep the phone in place until the tone transmission has finished. This takes about 15 seconds, and the display will count down the time. Once the countdown is over and the tones have stopped, resume your conversation with the specialist, who will then be able to assist you in using the information transmitted for analysis.

NOTE

- For best results, do not move the phone while the tones are being transmitted.
- If the call center agent is not able to get an accurate recording of the data, you may be asked to try again.

NOTE

- Call quality differences by region may affect the function.
- Use the home telephone for better communication performance, resulting in better service.
- Bad call quality may result in poor data transmission from your phone to the machine, which could cause Smart Diagnosis to not work properly.