



OWNER'S MANUAL

BOTTOM FREEZER

REFRIGERATOR

Please read this owner's manual thoroughly before operating and keep it handy for reference at all times.



MFL67567712

www.lg.com

TABLE OF CONTENTS

3 PRODUCT FEATURES

4 IMPORTANT SAFETY INSTRUCTIONS

7 COMPONENTS

- 7 Refrigerator Exterior
- 8 Refrigerator Interior

9 INSTALLATION

- 9 Installation Overview
- 10 Unpacking Your Refrigerator
- 10 Choosing the Proper Location
 - 10 - Flooring
 - 11 - Ambient Temperature
- 11 Turning On the Power
- 11 How to Remove the Refrigerator Door
- 12 How to Remove the Freezer Door
- 12 Height Adjustment
 - 12 - Fridge Door Height Adjustment
 - 13 - When the Freezer Door is Lower

14 HOW TO USE

- 14 Before Use
- 15 Control Panel
 - 15 - Control Panel Features
- 16 Storing Food
 - 16 - Food Storage Location
 - 18 - Food Storage Tips
 - 18 - Storing Frozen Food
- 19 Adjusting the Refrigerator Shelves
 - 19 - Detaching the Shelf
 - 19 - Refitting the Shelf
 - 20 - Using the Folding Shelf
 - 20 - When Closing the Door

- 21 Big Fresh Zone
 - 21 - Removal of the Big Fresh Zone drawer
 - 21 - Refitting the Big Fresh Zone drawer.
- 22 Extra Space
- 22 Fridge Basket
- 22 In & Out Carrier
- 23 Tilting Fresh Basket
- 23 Dairy Corner
- 24 Door-In-Door
 - 24 - Door-In-Door Shelf Disassembly
- 25 Adjustable Moving Basket
- 25 Freezer Drawer
 - 25 - Freezer Drawer Removal
 - 26 - Refitting the Freezer Drawer
- 26 Easy Ice Maker
 - 27 - How to Disassemble Easy Ice Maker
 - 28 - Cleaning the Ice tray
- 28 Freezer/Fridge Basket

29 MAINTENANCE

- 29 Cleaning
- 30 Replacing the Pure N Fresh filter

31 SMART DIAGNOSIS

- 31 Using Smart Diagnosis

32 TROUBLESHOOTING

PRODUCT FEATURES

* Depending on the model, some of the following functions may not be available.

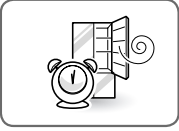

DOOR ALARM

The Door Alarm function is designed to prevent refrigerator malfunctioning that could occur if a refrigerator door or freezer door remains open. If a refrigerator door or freezer door is left open for more than 60 seconds, a warning alarm sounds in 30 second intervals until it is closed.



AUTO CLOSING HINGE

The refrigerator doors close automatically with a slight push. (The door only closes automatically when it is open at an angle less than 30°.)

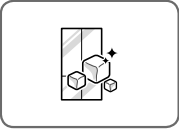

EXPRESS FREEZING

The freezer section is maintained at the coldest temperature for a 24-hour period before automatically resuming normal operation. The freezer display temperature will not change when Express Freezing is engaged. It will also enhance ice production whilst it is on.

IMPORTANT SAFETY INSTRUCTIONS

READ ALL INSTRUCTIONS BEFORE USING THE APPLIANCE.

This guide contains many important safety messages. Always **read and obey** all safety messages.



This is the safety alert symbol. It alerts you to safety messages that inform you of hazards that can kill or hurt you or others, or cause damage to the product.

All safety messages will be preceded by the safety alert symbol and the hazard signal word WARNING or CAUTION. These words mean:



WARNING You can be killed or seriously injured if you do not follow instructions.



CAUTION Indicates an imminently hazardous situation which, if not avoided, may result in minor or moderate injury, or product damage.



WARNING

To reduce the risk of fire, electric shock, or personal injury when using your product, basic safety precautions should be followed, including the following.

Power

- NEVER unplug your refrigerator by pulling on the power cord. Always grip the plug firmly and pull it straight out from the outlet.
- If the supply cord is damaged, it must be replaced by the manufacturer or its service agent or a similarly qualified person in order to avoid a hazard. Do not use a cord that shows cracks or abrasion damage along its length or at either the plug or connector end.
- Do not use an uncertified power outlet.
- Unplug the power plug immediately in the event of a blackout or thunderstorm.
- Plug in the power plug with the power cord facing downward.

Installation

- Contact an authorized service center when you install or relocate the refrigerator.
- When moving your refrigerator away from the wall, be careful not to roll over or damage the power cord.
- Connect this product to a dedicated grounded electric outlet conforming with the rating prior to use. It is the user's responsibility to replace a standard 2-prong wall outlet with a standard 3-prong wall outlet.
- Do not install the refrigerator where there may be a danger of it falling. Installation on a non sturdy timber floor may cause difficulty in door alignment and cause the cabinet to deform.

Use

- Do NOT allow children to climb, stand, or hang on the refrigerator doors or shelves in the refrigerator. They could damage the refrigerator and seriously injure themselves.
- Where fitted, do not place heavy objects on the dispenser of the refrigerator or hang onto it.
- Do not place heavy or dangerous objects (bottles or vases with liquid) on the refrigerator.
- Do not put live animals inside of the refrigerator.
- Do not allow children to climb into the product when it is in or out of use.
- In the event of a gas leak (propane/LPG), ventilate sufficiently and contact an authorized service center before use. Do not touch or disassemble the electric outlet of the refrigerator.
- In the event of a refrigerant leak, move flammable objects away from the refrigerator. Ventilate sufficiently and contact an authorized service center.
- Do not use or place flammable substances (chemicals, medicine, cosmetics, etc) near the refrigerator or store them inside the refrigerator. Do not place the refrigerator in the vicinity of flammable gas.

READ ALL INSTRUCTIONS BEFORE USING THE APPLIANCE.

To reduce the risk of fire, electric shock, or personal injury when using your product, basic safety precautions should be followed, including the following.

- This appliance is intended to be used in household and similar applications such as
 - staff kitchen areas, offices and other working environments;
 - farm houses and by clients in hotels, motels and other residential type environments;
 - bed and breakfast type environments.
- Do not use this product for special purposes or mobile applications (storage of medicine or test materials or on ships, etc).
- Unplug the power plug before cleaning or repairing the refrigerator.
- If the refrigerator is fitted with light bulbs and require replacing, unplug the refrigerator or turn off the power before doing so.
- Do not modify or extend the power cord.
- Do not use a hair dryer to dry the interior. Do not light a candle to remove any interior odor.
- For your safety, this appliance must be properly grounded. Have the wall outlet and the circuit checked by a qualified electrician to make sure the outlet is properly grounded.
- Do not use an outlet that can be turned off via a remote switch. Do not use an extension cord. It is the user's responsibility to replace a standard 2-prong wall outlet with a standard 3-prong wall outlet.
- Do not, under any circumstances, cut or remove the third (ground) prong from the power cord.
- Do not use an adapter plug and plug the power plug into a multi-outlet extension cord.
- Disconnect the power cord immediately if you hear a noise, smell a strange odor or detect smoke.
- Turn the power off if dust or water from above or below penetrates into the refrigerator. Call a service agent.
- Do not disassemble or modify the refrigerator.
- Do not put hands, feet, or metal objects below or behind the refrigerator.
- Do not operate the refrigerator or touch the power cord with wet hands.
- In refrigerators with automatic icemakers, avoid contact with the moving parts of the ejector mechanism or with the heating element that releases the cubes. Do not place fingers or hands on the automatic ice-making mechanism while the refrigerator is plugged in.
- When dispensing ice from the dispenser, do not use crystal ceramics.
- Do not touch the cold surfaces in the freezer compartment with wet or damp hands, when your refrigerator is in operation.
- Do not put glass containers, glass bottles or beverage cans in the freezer.
- Do not store explosive substances such as aerosol cans with a flammable propellant in this appliance.
- This appliance is not intended for use by persons (including children) with reduced physical, sensory or mental capabilities, or lack of experience and knowledge, unless they have been given supervision or instruction concerning the use of the appliance by a person responsible for their safety.
- Do not refreeze frozen foods that have thawed completely. It may result in serious health issues.
- If you are throwing away your old refrigerator, make sure the CFC coolant is removed for proper disposal by a qualified servicer. If you release CFC coolant, you may be fined or imprisoned in accordance with the relevant environmental law.
- Disposed or abandoned refrigerators are dangerous, even if they are sitting for only a few days. When disposing the refrigerator, remove the packing materials from the door or take off the doors but leave the shelves in place so that children may not easily climb inside.
- If the refrigerant gas has leaked, do not touch the refrigerator or the power outlet and ventilate the room immediately. A spark could trigger an explosion causing a fire or burns. Because this refrigerator uses natural gas (isobutene, R600a) as the environment-friendly refrigerant, even a small amount (50~60g) is combustible. If gas leaks from severe damage during delivering, installing or using the refrigerator, any spark may cause fire or burns.

READ ALL INSTRUCTIONS BEFORE USING THE APPLIANCE.

To reduce the risk of fire, electric shock, or personal injury when using your product, basic safety precautions should be followed, including the following.



CAUTION

Installation

- The refrigerator must be properly installed in accordance with the Installer Instructions that were taped to the front of the refrigerator.
- Be careful when you unpack and install the refrigerator. Immediately dispose of packing materials (plastic) out of reach of children.

Use

- Close the doors carefully when children are around.
- Keep fingers out of pinch point areas; clearances between the doors and cabinets are necessarily small. Be careful closing doors when children are in the area.
- If food is stacked or stored poorly on the shelves, it may fall and cause injury when the door is opened.
- Do not move refrigerator while the refrigerator is operating. A Compressor rattling noise may occur as a result and will only stop when the compressor cycles off, or when the power to the unit is turned off and back on again. (This is normal and will not impact on the performance or the life of the compressor. The rattling will stop after the compressor comes to a rest.)

Maintenance

- Do not use strong detergents like wax or thinners for cleaning. Clean with a soft fabric.
- Wipe foreign objects (dust, water, etc) off the prongs of the power plug and contact areas before connecting.



WARNING

- Use drinkable water for ice making.



WARNING

- Keep ventilation openings, in the appliance enclosure or in the built-in structure, clear of obstruction.
- Do not use mechanical devices or other means to accelerate the defrosting process, other than those recommended by the manufacturer.
- Do not damage the refrigerant circuit.
- Do not use electrical appliances inside the food storage compartments of the appliance, unless they are of the type recommended by the manufacturer.
- The refrigerant and insulation blowing gas used in the appliance require special disposal procedures. When disposal, please consult with service agent or a similarly qualified person.



This appliance contains a small amount of isobutane refrigerant (R600a), natural gas with high environmental compatibility, but it is also combustible. When transporting and installing the appliance, care should be taken to ensure that no parts of the refrigerating circuit are damaged. Refrigerant squirting out of the pipes could ignite or cause an eye injury. If a leak is detected, avoid any naked flames or potential sources of ignition and air the room in which the appliance is standing for several minutes.

In order to avoid the creation of a flammable gas air mixture if a leak in the refrigerating circuit occurs, the size of the room in which the appliance may be sited depends on the amount of refrigerant used. The room must be 1m² in size for every 8g of R600a refrigerant inside the appliance. The amount of refrigerant in your particular appliance is shown on the identification plate inside the appliance. Never start up an appliance showing any signs of damage. If in doubt, consult your dealer.

SAVE THESE INSTRUCTIONS

COMPONENTS

Use this page to become more familiar with the parts and features of your refrigerator. Page references are included for your convenience.

*The appearance and specifications of the actual product may differ depending on the model.

Refrigerator Exterior

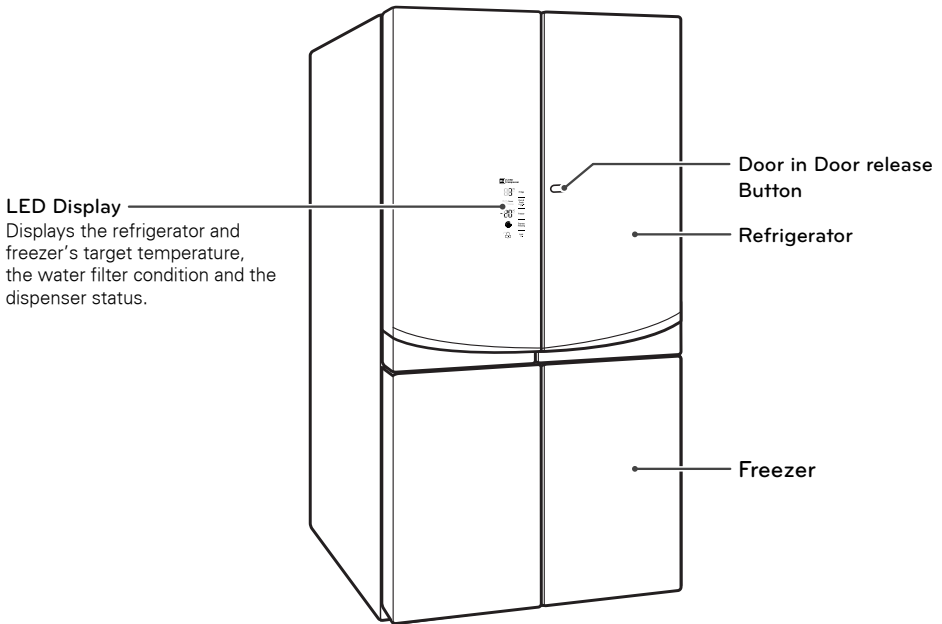

Refrigerator Interior

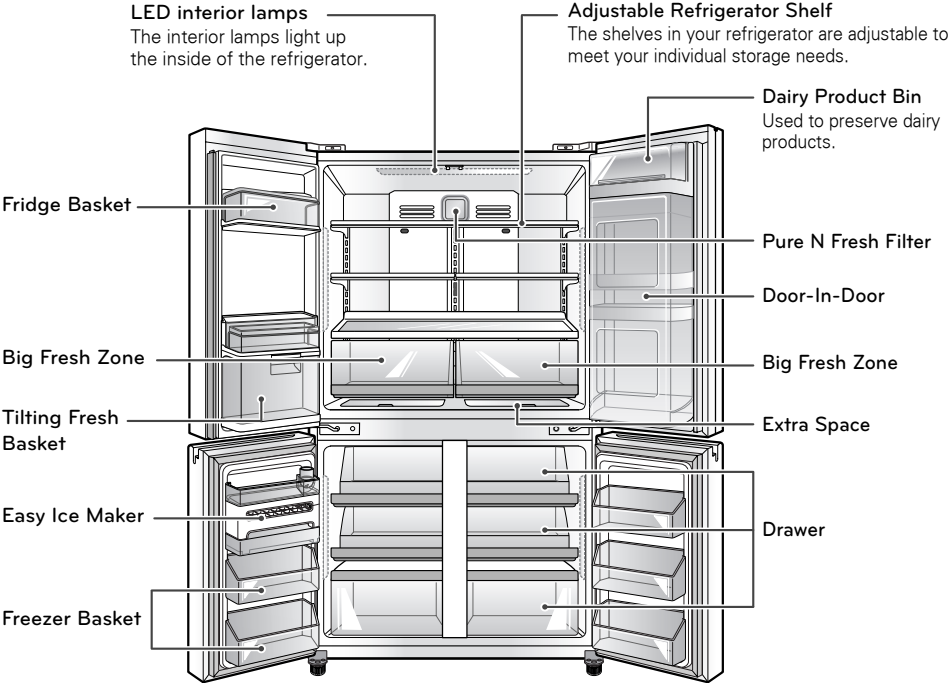

INSTALLATION

Installation Overview

Please read the following installation instructions first after purchasing this product or transporting it to another location.

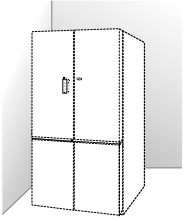

1 Unpacking your refrigerator

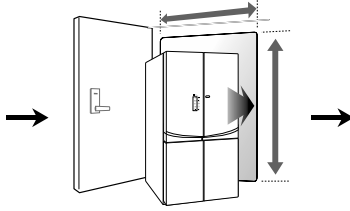

2 Choosing the proper location

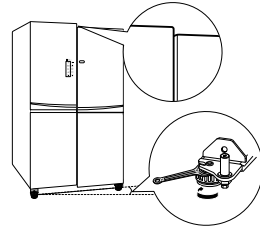

3 Leveling and Door Alignment

Unpacking Your Refrigerator

WARNING

- Use two or more people to move and install the refrigerator. Failure to do so can result in back or other injury.
- Your refrigerator is heavy. When moving the refrigerator for cleaning or service, be sure to protect the floor. Always pull the refrigerator straight out when moving it. Do not wiggle or walk the refrigerator when trying to move it, as floor damage could occur. Wind the leveling feet up first so that the unit is on its rollers.
- Keep flammable materials and vapors, such as gasoline, away from the refrigerator. Failure to do so can result in fire, explosion, or death.

Remove tape and any temporary labels from your refrigerator before using. Do not remove any warning-type labels, the model and serial number label, or the Tech Sheet that is located under the front of the refrigerator.

To remove any remaining tape or glue, rub the area briskly with your thumb. Tape or glue residue can also be easily removed by rubbing a small amount of liquid dish soap over the adhesive with your fingers. Wipe with warm water and dry.

Do not use sharp instruments, rubbing alcohol, flammable fluids, or abrasive cleaners to remove tape or glue. These products can damage the surface of your refrigerator.

Refrigerator shelves are installed in the shipping position. Please reinstall shelves according to your individual storage needs.

Choosing the Proper Location

- The refrigerator should always be plugged into its own individual properly grounded electrical outlet rated for 240 Volts, 50 Hz, AC only, and fused at 15 or 20 amperes. This provides the best performance and also prevents overloading house wiring circuits which could cause a fire hazard from overheated wires. It is recommended that a separate circuit serving only this appliance be provided.

WARNING

To reduce the risk of electric shock, do not install the refrigerator in a wet or damp area. do not install in any outdoor or sheltered outdoor location or direct sunlight.

Flooring

To avoid noise and vibration, the unit must be leveled and installed on a solidly constructed floor. If required, adjust the leveling legs to compensate for unevenness of the floor. The front should be slightly higher than the rear to aid in door closing. Leveling legs can be turned easily by tipping the cabinet slightly. Turn the leveling legs to the left to raise the unit or to the right to lower it. Poorly constructed timber flooring can cause a limit in door adjustment and the cabinet to become out of shape. (See Leveling and door Allgnment.)

NOTE

Installing on carpeting, soft tile surfaces, a platform or weakly supported structure is not recommended.

Ambient Temperature

Install this appliance in an indoor area where the temperature is between 13°C and 43°C. If the temperature around the appliance is too low or high, the cooling ability may be adversely affected.

- 1 Place your appliance where it is easy to use.
- 2 Avoid placing the unit near heat sources, direct sunlight or moisture.
- 3 To ensure proper air circulation around the fridge-freezer, please maintain sufficient space on both the sides as well as top and maintain at least 2 inches (5.08 cm) from the rear wall.
- 4 To avoid vibrations, the appliance must be leveled.
- 5 Don't install the appliance below 5°C. It may affect the performance.

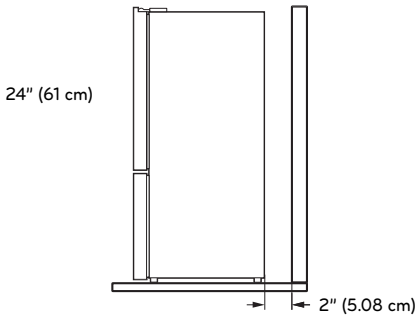

Turning On The Power

Plug in the refrigerator.

CAUTION

- Connect to a rated power outlet.
- Have a certified electrician check the wall outlet and wiring for proper grounding.
- Do not damage or cut off the ground terminal of the power plug.

How to Remove the Refrigerator Door (TURN OFF THE MAIN POWER. Same procedure for left and right doors)

- 1 Remove the refrigerator door hinge cover. (left side)

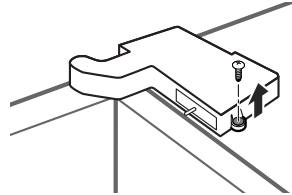

- 2 Disassemble connection plugs and ground wires.

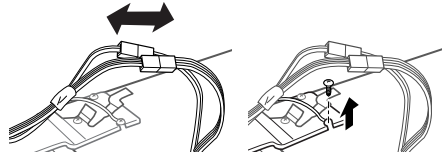

- 3 Turn ① around to release lock and raise hinge up.

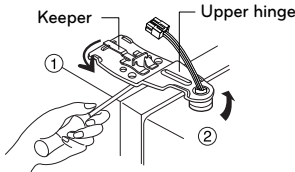

- 4 Disassemble Door, raising it from Hinge Center.

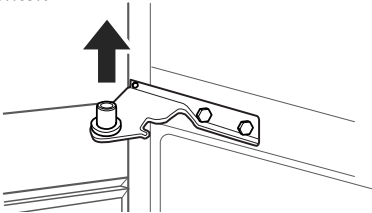

CAUTION
Remove it after you open Door to 90 degrees.

How to Remove the Freezer Door (TURN OFF THE MAIN POWER. Same procedure for left and right doors)

- 1 Remove the inner hinge bolt.

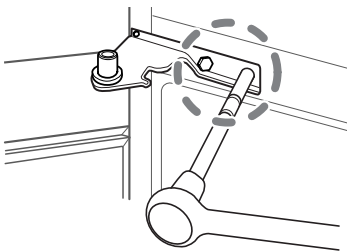

- 2 Twist the hinge to raise the pivoting end so that the door can be lifted off.

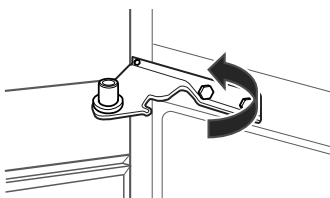

- 3 Remove the door by raising it from the lower hinge.

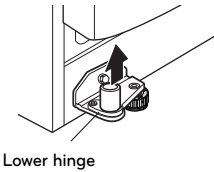

Height Adjustment

Leveling the doors may not be possible when the floor is not leveled, or is of weak or poor construction. The refrigerator is heavy and should be installed on a rigid and solid surface. Some Timber flooring may cause levelling difficulties if it flexes excessively.

Fridge Door Height Adjustment

- Raise refrigerator door up on lower side, using spanner, and adjust the door hinge bolt as per diagram below. (Spanner is enclosed with the instructions)
- Use spanner ① for refrigerator door adjustment.

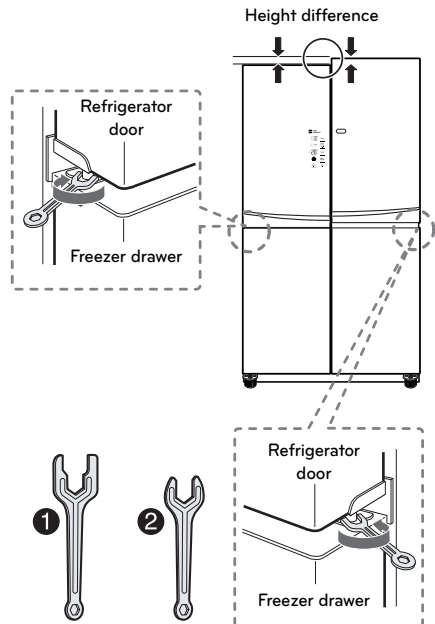

When the Freezer Door is Lower

- Method 1 is recommended.
- Use spanner ② for freezer door adjustment.

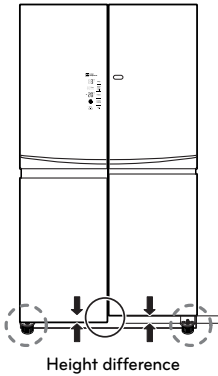

1 (Method 1 recommended.)

Open the door and adjust the level by using the nut on the adjustable round foot of the lower side first by using the supplied number ② spanner as per the below diagram.

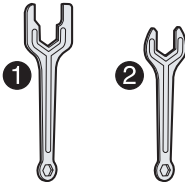
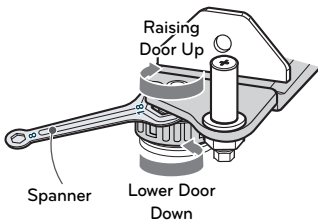

2 (Method 2)

- (1) Using the large side of the number ② spanner, rotate the locking nut (↻) clockwise to unlock it before adjusting the Adjust-Hinge pin.

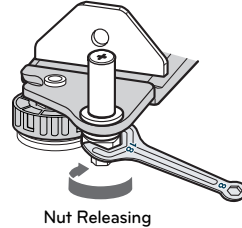

- (2) Rotate the Adjust-hinge pin either (↻) clockwise or (↺) counter-clockwise using the narrow side of the spanner to adjust the level difference between the refrigerator door and freezer door (this method provides limited adjustment).

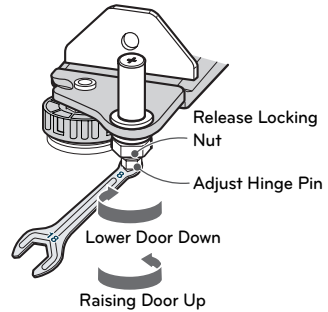

- (3) After adjusting door height, firmly tighten the Locking nut (↺) counter-clockwise until secured.

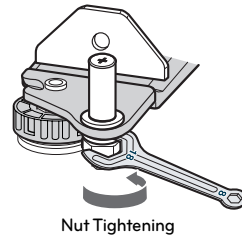

⚠ CAUTION

Do not adjust the hinge pin height level too much. The hinge pin can fall out. (Range of height adjustment : Max. 3mm)

HOW TO USE

Before use

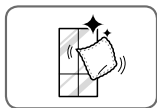

Clean the refrigerator.

Clean your refrigerator thoroughly and wipe off all dust that may have accumulated during shipping.



CAUTION

- Do not scratch the refrigerator with a sharp object or use a detergent that contains alcohol, a flammable liquid or an abrasive when removing any tape or adhesive from the refrigerator.
- Do not peel off the model or serial number label or the technical information on the rear surface of the refrigerator.



NOTE

Remove adhesive residue by wiping it off with your thumb or dishwashing detergent.

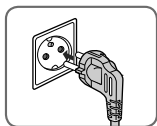

Connect the power supply.

Check if the power supply is connected before use.

Read the "Turning On The Power" section. (Your plug type might be different from the picture.)

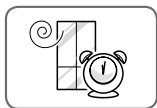

Wait for the refrigerator to cool.

Allow your refrigerator to run for at least three to four hours before putting food in it. Check the flow of cold air in the freezer compartment to ensure proper cooling.



CAUTION

Putting food in the refrigerator before it has cooled could cause the food to spoil, or a bad odor could remain inside the refrigerator.

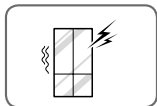

The refrigerator makes a loud noise after initial operation.

This is normal. The loudness will decrease as the temperature lowers.

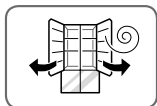

Before Plugging in, open the refrigerator doors to ventilate the interior.

The inside of the refrigerator may smell like plastic at first. Remove any adhesive tape from inside the refrigerator and open the refrigerator doors for ventilation until any odors have subsided.

Control Panel

Control Panel Features

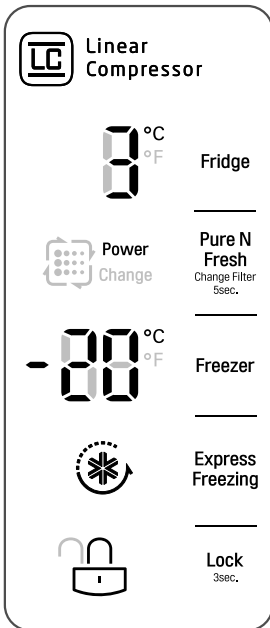

Fridge Temperature

Indicates the set target temperature of the refrigerator compartment in Celsius (°C).

The recommended Fridge set temperature in normal ambient conditions and loads is 3°C ~ 4°C.

Freezer Temperature

Indicates the set target temperature of the freezer compartment in Celsius (°C).

The recommended Freezer set temperature in normal ambient conditions and loads is -18°C ~ -20°C.

NOTE

The displayed temperature is the target temperature, and not the actual temperature of the refrigerator. The actual refrigerator temperature depends on the food inside the refrigerator as well as ambient temperatures and how often the doors are opened and closed.

Express Freezing

This function increases both ice making and freezing capabilities.

- When you touch the **Express Freezing** button, the graphic will illuminate in the display and will continue for 3 hours. The function will automatically disable itself after 3 hours.
- You can stop this function manually by touching the button one more time.

Pure N Fresh

When the Change lamp is on, replace the Pure N Fresh filter.

- When the "Change" lamp is turned on, replace the filter to maintain the performance of the Pure N Fresh Filter function.
- To replace the filter, press the **Pure N Fresh Change Filter** button on the touch control panel to the OFF mode so that the filter icon is not illuminated and the blue Pure N Fresh LED inside the refrigerator remains off. The Pure N Fresh function has three modes, Auto (default mode when icon is lit up) Power mode (when icon and Power are lit up) and Off (icon is not lit up) Power mode can be engaged by pressing the Pure N Fresh touch control respectively. Auto > Power > Off > Auto..... Power mode will resume back to Auto mode after 4 hours.

Control Lock

The Control Lock function disables the button functions only on the display.

- When power is initially connected to the refrigerator, the **Lock** function is off.
- If you want to activate the **Lock** function to lock other buttons, press and hold the **Lock** button for three seconds or more. The **Lock** icon will display and the **Lock** function is now enabled.
- To disable the **Lock** function, press and hold the **Lock** button for approximately three seconds.

Storing Food

Food Preservation Location

Each compartment inside the refrigerator is designed to store different types of food. Store your food in the optimal space to enjoy the freshest taste.

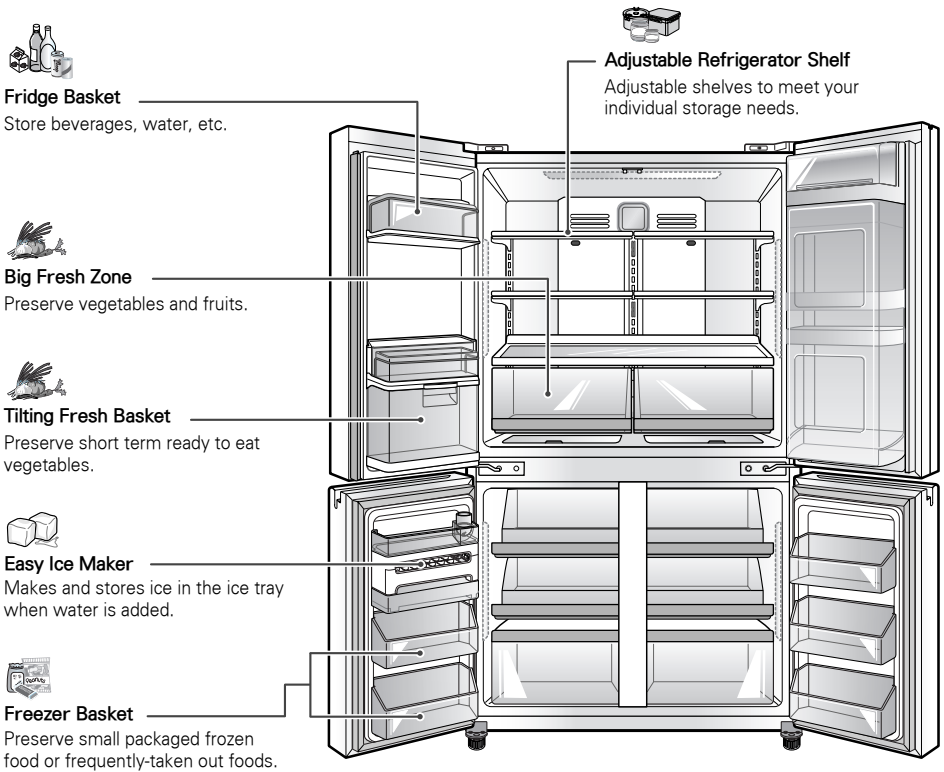

Food Preservation Location (continued)

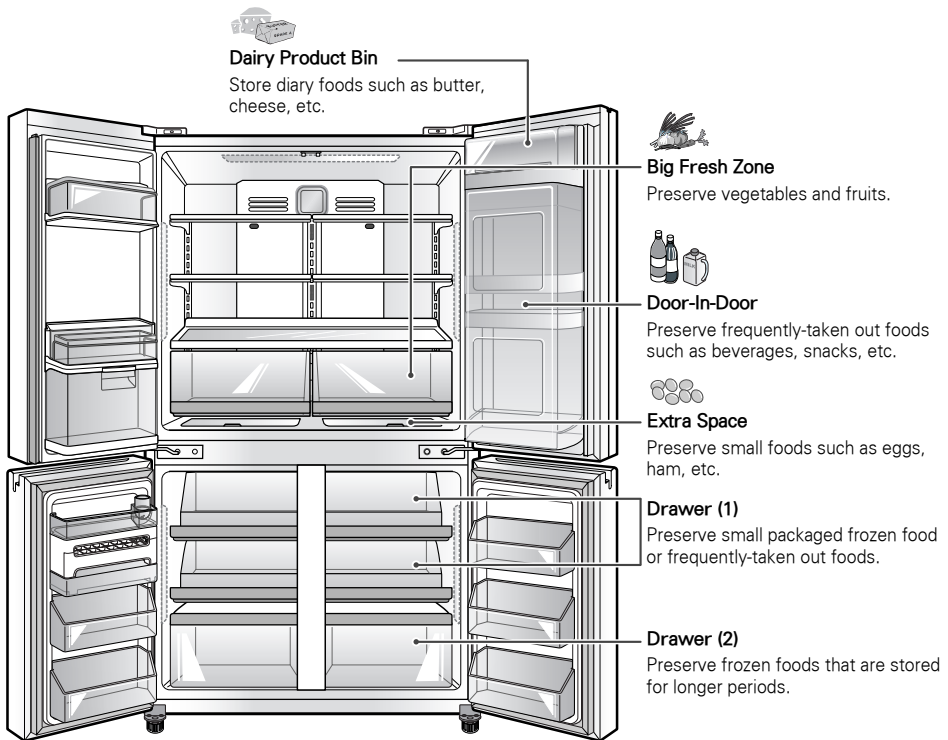

CAUTION

- Do not store food with high moisture content towards the top of the refrigerator. The moisture could come in direct contact with the cold air and freeze.
- Wash food before storing it in the refrigerator. Vegetables and fruit should be washed, and food packaging should be wiped down to prevent adjacent foods from being contaminated.
- If the refrigerator is kept in a hot and humid place, frequent opening of the door or storing a lot of vegetables in the refrigerator may cause condensation to form. Wipe off the condensation with a clean cloth or a paper towel.
- If the refrigerator doors are opened or closed too often, warm air may penetrate the refrigerator and raise its temperature. It can also increase the refrigerator's electricity usage.



NOTE

- If you are leaving home for a short period of time, like a short vacation, the refrigerator should be left on. Refrigerated foods that are able to be frozen will stay preserved longer if stored in the freezer.
- If you are leaving the refrigerator turned off for an extended period of time, remove all food and unplug the power cord. Clean the interior, and leave the doors slightly ajar to prevent mold from growing in the refrigerator.
- The Cheese & Butter and Condiment bins are not recommended for storing items that spoil easily such as milk and mayonnaise.

Food Storage Tips

* The following tips may not be applicable depending on the model.

Wrap or store food in the refrigerator in airtight and moisture-proof material unless otherwise noted. This prevents food odor and taste transfer throughout the refrigerator. For dated products, check use by dates to ensure freshness.

Food	How to
Butter or Margarine	Keep opened butter in a covered dish or closed compartment. When storing an extra supply, wrap in freezer packaging and freeze.
Cheese	Store in the original wrapping until you are ready to use it. Once opened, rewrap tightly in plastic wrap or aluminum foil.
Milk	Wipe milk cartons. For best storage, place milk on interior shelf, not on door shelf.
Eggs	Store in original carton on interior shelf, not on door shelf.
Fruit	Do not wash or prepare fruit until it is ready to be used. Sort and keep fruit in its original container, in a crisper, or store in a completely closed paper bag on a refrigerator shelf.
Leafy Vegetables	Remove store wrapping and trim or tear off bruised and discolored areas. Wash in cold water and drain. Place in plastic bag or plastic container and store in crisper.
Vegetables with skins (carrots, peppers)	Place in plastic bags or plastic container and store in crisper.
Fish	Store fresh fish and shellfish in the freezer section if they are not being consumed the same day of purchase. It is recommended to consume fresh fish and shellfish the same day purchased.
Leftovers	Cover leftovers with plastic wrap, aluminum foil, or plastic containers with tight lids.

Storing Frozen Food

NOTE

Check a freezer food guide or a reliable cookbook for further information about preparing food for freezing or food storage times.

Freezing

Your freezer will not quick-freeze a large quantity of food. Do not put more unfrozen food into the freezer than will freeze within 24 hours (no more than 1 to 1.5kg. of food per cubic foot of freezer space). Leave enough space in the freezer for air to circulate around packages. Be careful to leave enough room at the front so the door can close tightly.

Storage times will vary according to the quality and type of food, the type of packaging or wrap used (how airtight and moisture-proof) and the storage temperature. Ice crystals inside a sealed package are normal. This simply means that moisture in the food and air inside the package have condensed, creating ice crystals.

NOTE

Allow hot foods to cool at room temperature for 30 minutes, then package and freeze. Cooling hot foods before freezing saves energy.

NOTE

Never freeze beverage cans or bottles of any kind as they can explode or shatter.

Storing Frozen Food (continued)

Packaging

Successful freezing depends on correct packaging. When you close and seal the package, it must not allow air or moisture in or out. If it does, you could have food odor and taste transfer throughout the refrigerator and could also dry out frozen food.

Packaging recommendations:

- Rigid plastic containers with tight-fitting lids
- Straight-sided canning/freezing jars
- Heavy-duty aluminum foil
- Plastic-coated paper
- Non-permeable plastic wraps
- Specified freezer-grade self-sealing plastic bags

Follow package or container instructions for proper freezing methods.

Do not use

- Bread wrappers
- Non-polyethylene plastic containers
- Containers without tight lids
- Wax paper or wax-coated freezer wrap
- Thin, semi-permeable wrap

Adjusting the Refrigerator Shelves

The shelves in your refrigerator are adjustable to meet your individual storage needs. Your model may have either glass or wire shelves.

Adjusting the shelves to fit different heights of items will make finding the exact item you want easier. Doing so will also reduce the amount of time the refrigerator door is open which will save energy.

Detaching the Shelf

Tilt up the front of the shelf and lift it straight up. Pull the shelf out.

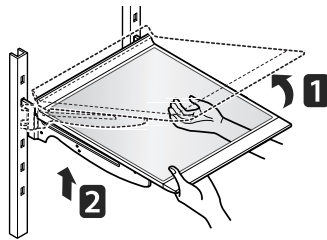

Refitting the Shelf

Tilt the front of the shelf up and guide the shelf hooks into the slots at the desired height. Then, lower the front of the shelf so that the hooks drop into the slots.

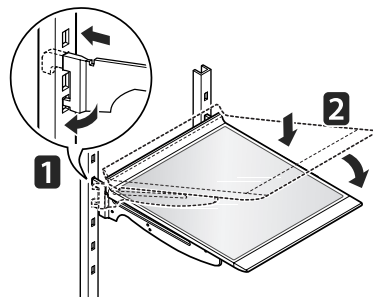

CAUTION

Make sure that shelves are level from one side to the other. Failure to do so may result in the shelf falling or spilling food.

Using the Folding Shelf

You can store taller items, such as containers or bottles, by simply pushing the front half of the shelf underneath the back half of the shelf. Pull the front of the shelf firmly toward you to return to a full shelf.

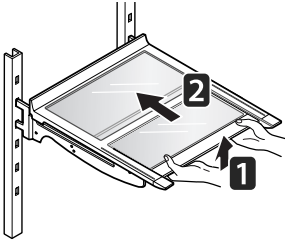

CAUTION

- Do not clean glass shelves with warm water while they are cold. Shelves may break if exposed to sudden temperature changes or impact.
- Glass shelves are heavy. Use special care when removing them.

When Closing the Door

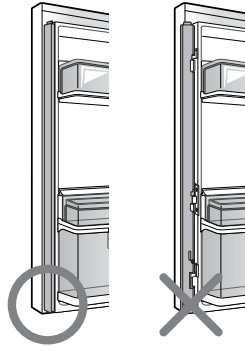

CAUTION

- To reduce the risk of door scratches and breaking the door centre mullion, please make sure that the refrigerator door mullion is always folded in.
- The door Alarm will sound if the door remains open after 1 minute. Ensure that the folding mullion is folded in before closing the left hand door.

Big Fresh Zone

Removal of the Big Fresh Zone drawer.

The Moisture (balance) keeper helps optimize humidity in the vegetable compartment.

- 1 Pull the drawer back to the end of its travel.

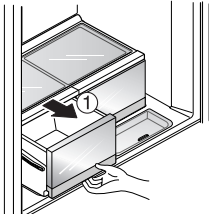

- 2 Lift the front of the draw up and remove it from its guide.

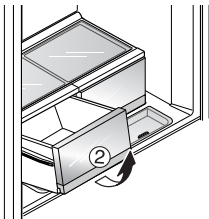

CAUTION

- Always empty the draws before removing them and use both hands when removing and refitting.
- Make sure that the refrigerator doors are fully open before removing and refitting the drawers.

Refitting the Big Fresh Zone drawer.

- 1 Insert the left and right roller of the drawer into the guides whilst the draw is slightly lifted at the front, and push it in gently while lowering it at the same time.

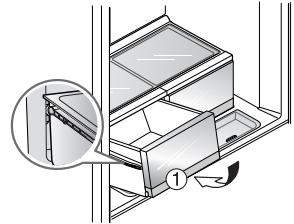

- 2 Push it in gently while lowering it at the same time.

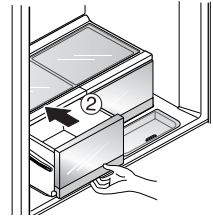

Extra Space

Store small foods like eggs, ham, cheese, etc.

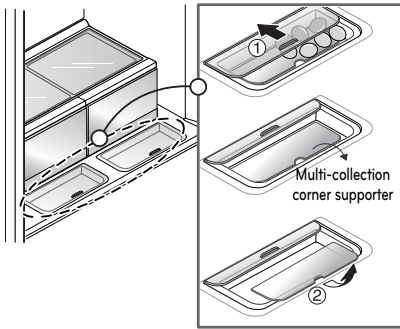

- Open and close pushing or pulling grips.



CAUTION

- Be careful when handling and storing larger eggs. They can be broken if the cover is not completely closed and the drawer is pushed in.
- Observe the above diagrams when removing and refitting the Multi-Collection corner after cleaning.
- Store all moist and easily-freezing foods like soy bean curd, sesame leaf, etc. on the front of the shelves.

Fridge Basket

Preserve drinks like small packs, milk, beer, juice etc.

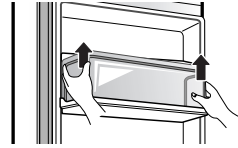

In & Out Carrier

Ideally used to store and carry multiple items to and from the refrigerator.

- When necessary, In & Out Carrier may be taken out separately. It can be used to move required condiments, drinks, snacks, etc. for cooking at the same time.

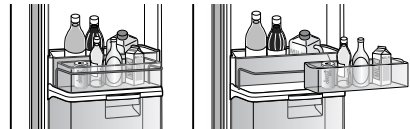
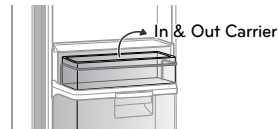

- This basket must only be used for items stored in the refrigerator. Do not place near any heat sources.

Tilting Fresh Basket

Ideal for storing vegetables soon to be eaten.

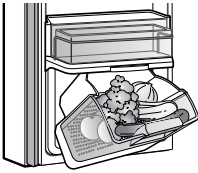

To open, lift the latch and gently pull the basket back.

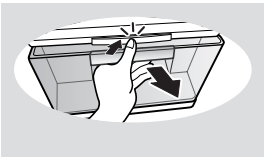

< OPEN >

To close, push the basket in until a “click” sound is heard.

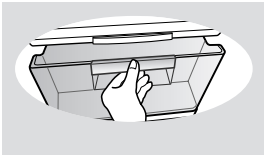

< CLOSE >

- To avoid damaging the drawer, do not overload it or apply excessive force when opening or closing.



CAUTION

- Do not allow children to hang from the basket when it is open or closed. This will damage the basket and could cause injury.

Dairy Corner

You can store dairy products such as butter, cheese etc.

If you close the refrigerator door with the dairy corner left open, the refrigerator door may not close properly. It could also result in damage to the lid.



Door-In-Door

The Door-In-Door compartment allows for easy access of commonly used food items.

The inner Door-In-Door includes two door bins, Cheese & Butter and Condiment bins, that are specially designed for food that can be stored at a warmer temperature. This makes spreading butter and slicing cheese easier.



NOTE

The Cheese & Butter and Condiment bins are not recommended for storing items that spoil easily such as milk and mayonnaise.

Press the the door button on the Home Bar until you hear a click sound.

- You can store more food in the larger Home Bar.
- With the larger storage room, you can organize your foods better.

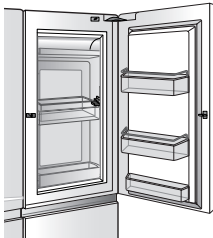
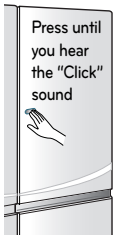

Door-In-Door Shelf Disassembly

- 1 Raise magicspace cover up and take it out.

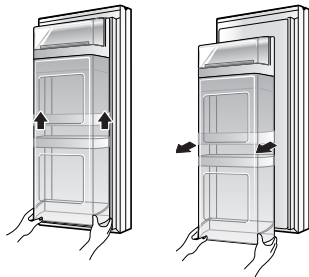

- 2 Hold the bottom of daily basket and raise it up to take it out.

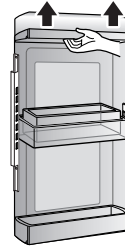

- 3 Move floating basket to the top compartment from magic space cover from which daily corner is removed.

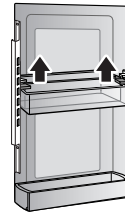

- 4 Remove screws on both sides of magic space cover.

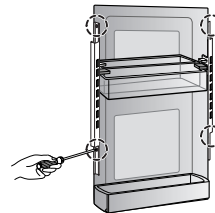

- 5 Hold the bottom of lower basket and raise it up to take it out.

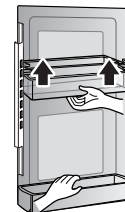

Hold both ends of the basket and lift up the front part of the basket.

- Assemble in the same method as disassembly.

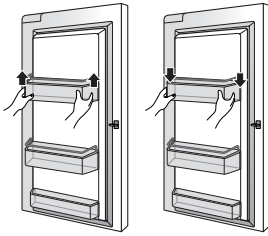

Adjustable Moving Basket

It can be moved up and down as necessary, and used conveniently.

- To move Adjustable Moving Basket up or down, remove all items from the basket first.
- Hold the center of basket gently with upward pressure
- Press the levers on both sides at the bottom of the lower section upward, and then move it up or down.
- Adjusting the Moving Door Basket allows taller food items to be stored more conveniently.

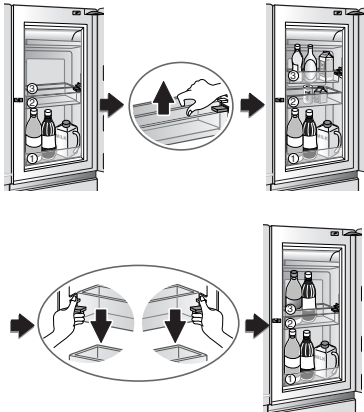

CAUTION

- Remove all food items from basket before moving it up or down. Not doing so could cause damage to the basket or food items.

Freezer Drawer

Use the compartment for packed frozen foods and frequently-taken out foods.

Use the bottom compartment for frozen foods. (Dried fish & condiments)

- The sliding freezer drawers allow easy access and convenience of use.

Freezer Drawer Removal

- 1 Pull out the Freezer drawer to the end of its travel (as per below fig) and remove all of the contents.

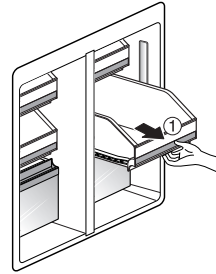

- 2 When the drawer is fully extended, lift up the front and continue to pull it out (as per below fig).

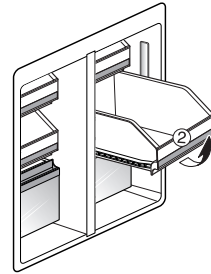

CAUTION

- Always remove drawers with both hands to avoid breakage or injury.
- Always open the freezer doors all the way before removing or refitting the drawers.

Refitting the Freezer Drawer

- 1 Insert both rollers into the guides with the front of the drawer slightly raised and gently push in. while lowering the drawer to the correct level.

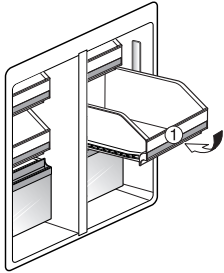

- 2 Continue to push in the drawer all the way while lowering the drawer to the correct level.

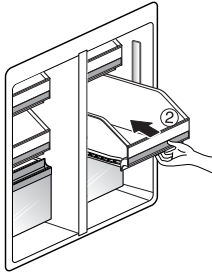

CAUTION

- Always remove drawers with both hands to avoid breakage or injury.
- Always open the freezer doors all the way before removing or refitting the drawers.

Easy Ice Maker

- Remove the water reservoir from the ice maker assembly.
- Open the lid and fill with water to the indicated guide line.
- Refit the lid and swiftly place the filled water reservoir back into the ice maker.

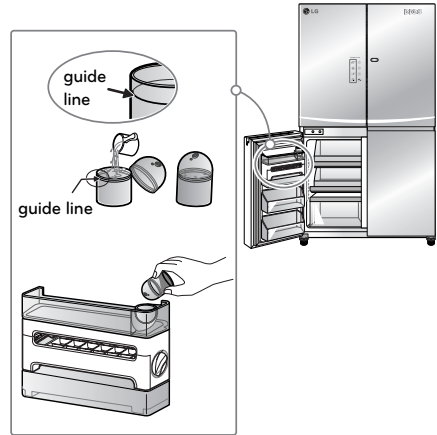

Filling The Ice Tray Manually.



- Take out the empty ice tray, fill it with water to the level line, and carefully push it back in to avoid spilling the water.
- Ensure that it is slowly pushed all the way back in (as per below fig.) before gently closing the Freezer door.

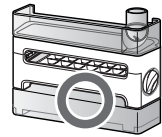
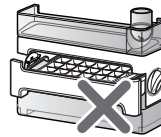



CAUTION

- It is normal for the water reservoir bottle to have some ice in it. remove any ice from it when refilling it.
- Ensure that there is enough space in the ice bank before twisting ready made ice out from the ice tray.

- Lift the ice bin gently when removing it if it has ice in it.
- Ensure the ice tray is fully inserted when refitting.
- The ice storage bin has a maximum storage capacity of 3 ice tray harvests. Over filling the ice bin will cause it to jam when removing it.

Ejecting Ready Made Ice.

- Turn the rotary knob firmly until all the ice has ejected from the ice tray into the ice bin. Repeat the twisting action if necessary until all ice is removed.
- If unfrozen ice is ejected into the ice bin, it will cause the existing ice cubes in the ice bin to lump together.
(It takes about 4 hours for ice production at -20°C)

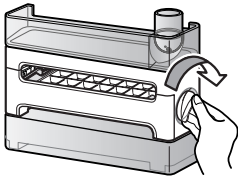
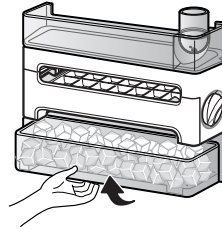

CAUTION

- If the freezer door (door of the ice maker) is frequently opened, warm air enters the freezer, and the time for water to freeze may be longer.
- Ice may not be made until 24 hours after the initial installation of the refrigerator.
- Be careful of pointed corners of some dispensed ice cubes.

How to Disassemble Easy Ice Maker

- 1 Hold both ends of door basket on upper part of easy ice maker to remove it upward.

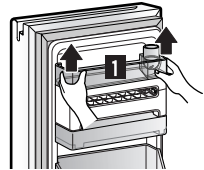

- 2 Hold both ends of defrosting compartment on upper part of easy ice maker to remove it upward.

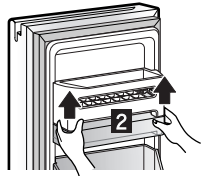

CAUTION

- Disassembly must be in the above order to avoid damage to the ice maker parts
- When the ice making section is storage bin, hold it level and pull it out so that the ice storage bin does not fall out.

Cleaning the Ice tray

- 1 Remove the ice tray by pulling it out.
Caution should be taken if the ice tray is full of ice. Dispose of any ice if it is contaminated.
- 2 Clean the ice tray only with running water before refitting it back into the original position.

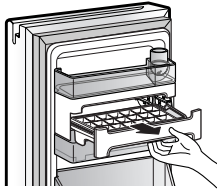

CAUTION

- Clean the other parts of the ice maker with a damp towel only and dry completely before refitting. not doing so may cause the ice twisting mechanism to freeze and not operate.

Freezer/Fridge basket

You can store small packaged frozen food (Freezer basket), small packaged refrigerated food or beverages (Fridge basket) such as milk, water, juice, beer etc.

Do Not store ice cream or foods intended for long term storage in the Freezer Basket.

To remove the basket, hold the basket with both hands and slightly lift up the front part to pull it out.

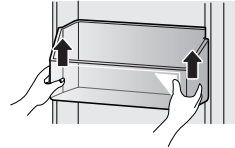

To refit the basket, align both sides of the basket with the guides and push it down until secure.

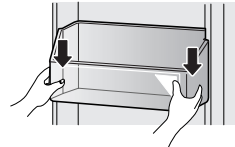

Two Stars Section ** (Applicable to Some Models Only)

- Two stars section means suitable for ice or foods that can be stored at -12°C ~ -18°C .
- Not suitable for deep freezing.

MAINTENANCE

Cleaning

- Both the refrigerator and freezer sections defrost automatically; however, clean both sections about once a month to prevent odors.
- Wipe up spills immediately.
- Always unplug the refrigeration before cleaning.

General Cleaning Tips

- Unplug refrigerator or disconnect power.
- Remove all removable parts, such as shelves, crispers, etc.
- Use a clean sponge or soft cloth and a mild detergent in only warm water. Do not use abrasive or harsh cleaners.
- Hand wash, rinse and dry all surfaces thoroughly.

Exterior

Waxing external painted metal surfaces helps provide rust protection. Do not wax plastic parts. Wax painted metal surfaces at least twice a year using appliance wax (or auto paste wax). Apply wax with a clean, soft cloth.

For products with a stainless steel exterior, use a clean sponge or soft cloth and a mild detergent in warm water. Do not use abrasive or harsh cleaners. Dry thoroughly with a soft cloth.

WARNING

Use non-flammable cleaner. Failure to do so can result in fire, explosion, or death. Always remove power cord from the wall outlet prior to cleaning in the vicinity of electrical parts (lamps, switches, covers, controls, etc.).

Wipe up excess moisture with a sponge or cloth to prevent water or Liquid from getting into any electrical part and causing an electric shock.

Never use metallic scouring pads, brushes, coarse abrasive cleaners, Strong alkaline solutions, industrial detergent (bleach containing detergent) Flammable or toxic cleaning liquids on any surface. Do not use Hot water to clean the interior or any interior parts of the unit when they are cold.

CAUTION

- Do not use a rough cloth or sponge when cleaning the interior and exterior of the refrigerator.
- Do not place your hand on the bottom surface of the refrigerator when opening and closing.

Inside Walls (allow freezer to warm up so the cloth will not stick)

To help remove odors, you can wash the inside of the refrigerator with a mixture of baking soda and warm water. Mix 2 tablespoons of baking soda to 1 litre of warm water. Be sure the baking soda is completely dissolved so it does not scratch the surfaces of the refrigerator.

Door Liners and Gaskets

Use a clean sponge or soft cloth and a mild detergent in warm water. Do not use cleaning waxes, concentrated detergents, bleaches, or cleaners containing petroleum on plastic refrigerator parts.

Plastic Parts (covers and panels)

Use a clean sponge or soft cloth and a mild detergent in warm water. Do not use window sprays, abrasive cleansers, or flammable fluids. These can scratch or damage the material.

Condenser Coil Cover

Use a vacuum cleaner with an attachment to clean the condenser cover and vents located at the rear of the appliance. Do not remove the panel covering the condenser coil area. Always disconnect the main power before cleaning.

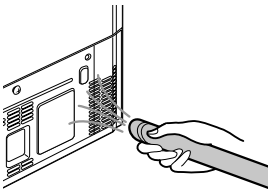

Replacing the Pure N Fresh filter

It is recommended that you replace the Pure N Fresh filter:

- Approximately every 1~2 years.
- When the CHANGE FILTER light turns on.

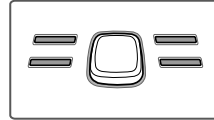

1 Remove the Old Filter

Turn the filter cover to the left to detach from the refrigerator wall. The filter is located on the inside of the filter cover. Remove the filter from the cover and replace it with a new filter.

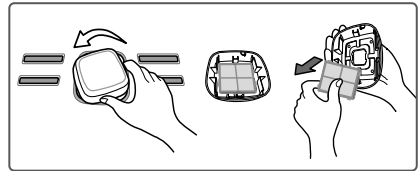

2 Installing a New Pure N Fresh filter.

Place the new filter inside of the cover with the side that says "Front" facing outward. Turn the filter cover to the right to reattach it to the refrigerator wall.

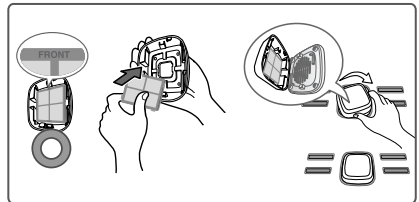

After changing the filter, touch and hold the Pure N Fresh filter button on the front display for three seconds to reset the filter sensor.

SMART DIAGNOSIS



Should you experience any problems with your refrigerator, it has the capability of transmitting data via your telephone to the LG service center. This gives you the capability of speaking directly to our trained specialists. The specialist records the data transmitted from your machine and uses it to analyze the issue, providing a fast and effective diagnosis.

If you experience problems with your refrigerator, call to the LG service center. Only use the Smart Diagnosis feature when instructed to do so by the LG call center agent. The transmission sounds that you will hear are normal and sound similar to a fax machine.

Smart Diagnosis cannot be activated unless your refrigerator is connected to power. If your refrigerator is unable to turn on, then troubleshooting must be done without using Smart Diagnosis.

Using Smart Diagnosis

First, call to the LG service center. Only use the Smart Diagnosis feature when instructed to do so by the LG call center agent.

- 1 Lock the display. To lock the display, press and hold the Lock button for three seconds. (If the display has been locked for over five minutes, you must deactivate the lock and then reactivate it.)

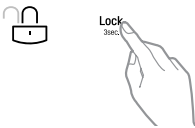

- 2 Open the right refrigerator door.

- 3 Hold the mouthpiece of your phone in front of the speaker that is located on the right hinge of the refrigerator door, when instructed to do so by the call center.

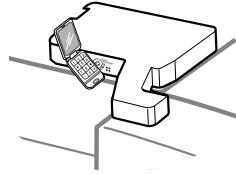

- 4 Press and hold the Freezer Temperature button for three seconds while continuing to hold your phone to the speaker.



- 5 After you hear three beeps, release the Freezer Temperature button.
- 6 Keep the phone in place until the tone transmission has finished. This takes about 3 seconds, and the display will count down the time. Once the countdown is over and the tones have stopped, resume your conversation with the specialist, who will then be able to assist you in using the information transmitted for analysis.

NOTE

- For best results, do not move the phone while the tones are being transmitted.
- If the call center agent is not able to get an accurate recording of the data, you may be asked to try again.

NOTE

- Call quality differences by region may affect the function.
- Use the home telephone for better communication performance, resulting in better service.
- Bad call quality either from a mobile or home phone may result in poor data transmission from your phone to the diagnostics call centre, which could cause Smart Diagnosis to not work properly.

TROUBLESHOOTING

Review the Troubleshooting section before calling for service; doing so will save you both time and money.

Problem	Possible Causes	Solutions
Refrigerator and Freezer section are not cooling.	The refrigerator display control is set to OFF (some models).	Cancel the OFF mode so that the unit commences operation. Refer to the Setting the Controls section for proper temperature settings, or call Customer Service if OFF remains on the Display panel.
	Refrigerator is in the defrost cycle.	During the defrost cycle, the temperature of each compartment may raise slightly. Wait 40 minutes to confirm the proper temperature has been restored once the defrost cycle has completed.
	Refrigerator was recently installed.	It may take up to 24 hours for each compartment to reach the desired temperature.
	Refrigerator was recently relocated.	If the refrigerator was stored for a long period of time or moved on its side, it is necessary for the refrigerator to stand upright for 24 hours before connecting it to power.
Cooling System runs too much.	Refrigerator is replacing an older model.	Modern refrigerators require more operating time but use less energy due to more efficient technology.
	Refrigerator was recently plugged in or power restored.	The refrigerator will take up to 24 hours to cool completely.
	Door opened often or a large amount of food / hot food was added.	Adding food and opening the door warms the refrigerator, requiring the compressor to run longer in order to cool the refrigerator back down. In order to conserve energy, try to get everything you need out of the refrigerator at once, keep food organized so it is easy to find, and close the door as soon as the food is removed. (Refer to the Food Storage Guide.)
	Doors are not closed completely.	Firmly push the doors shut. If they will not shut all the way, see the Doors will not close completely or pop open section in Parts & Features Troubleshooting.
	Refrigerator is installed in a hot location.	The compressor will run longer under warm conditions. At normal room temperatures 21°C expect your compressor to run about 40% to 80% of the time. Under warmer conditions, expect it to run even more often. The refrigerator should not be operated above 43°C.
	Condenser / back cover is clogged.	Use a vacuum cleaner with an attachment to clean the condenser cover and vents. Do not remove the panel covering the condenser coil area. Disconnect the mains before cleaning.

Problem	Possible Causes	Solutions
Refrigerator or Freezer section is too warm.	Refrigerator was recently installed.	It may take up to 24 hours for each compartment to reach the desired temperature.
	Air vents are blocked.	Rearrange items to allow air to flow throughout the compartment. Refer to the Airflow diagram in the Using Your Refrigerator section.
	Doors are opened often or for long periods of time.	When the doors are opened often or for long periods of time, warm, humid air enters the compartment. This raises the temperature and moisture level within the compartment. To lessen the effect, reduce the frequency and duration of door openings.
	Unit is installed in a hot location.	The refrigerator should not be operated in temperatures above 43°C.
	A large amount of food or hot food was added to either compartment.	Adding food warms the compartment requiring the cooling system to run. Allowing hot food to cool to room temperature before putting it in the refrigerator will reduce this effect.
	Doors not closed correctly.	See the Doors will not close correctly or pop open section in Parts & Features Troubleshooting.
	Temperature control is not set correctly.	If the temperature is too warm, adjust the control one increment at a time and wait for the temperature to stabilize. Refer to the Setting the Controls section for more information.
	Defrost cycle has recently completed.	During the defrost cycle, the temperature of each compartment may raise slightly and condensation may form on the back wall. Wait 40 minutes and confirm the proper temperature has been restored once the defrost cycle has completed.

Problem	Possible Causes	Solutions
Interior moisture buildup.	Doors are opened often or for long periods of time.	When the doors are opened often or for long periods of time, warm, humid air enters the compartment. This raises the temperature and moisture level within the compartment. To lessen the effect, reduce the frequency and duration of door openings.
	Doors not closed correctly.	See the Doors will not close correctly section in the Troubleshooting section.
	Weather is humid.	Humid weather allows additional moisture to enter the compartments when the doors are opened leading to condensation or frost. Maintaining a reasonable level of humidity in the home will help to control the amount of moisture that can enter the compartments.
	Defrost cycle recently completed.	During the defrost cycle, the temperature of each compartment may be raised slightly and condensation may form on the back wall. Wait 40 minutes and confirm that the proper temperature has been restored once the defrost cycle has completed.
	Food is not packaged correctly.	Food stored uncovered or unwrapped, and damp containers can lead to moisture accumulation within each compartment. Wipe all containers dry and store food in sealed packaging to prevent condensation and frost.
Food is freezing in the refrigerator compartment.	Food with high water content was placed near an air vent.	Rearrange items with high water content away from air vents.
	Refrigerator temperature control is set incorrectly.	If the temperature is too cold, adjust the control one increment at a time and wait for the temperature to stabilize. Refer to the Setting the Controls section for more information.
	Refrigerator is installed in a cold location.	When the refrigerator is operated in temperatures below 5°C, food can freeze in the refrigerator compartment. The refrigerator should not be operated in temperature below 13°C.
Frost or ice crystals form on frozen food (outside of package).	Door is opened frequently or for long periods of time.	When the doors are opened often or for long periods of time, warm, humid air enters the compartment. This raises the temperature and moisture level within the compartment. Increased moisture will lead to frost and condensation. To lessen the effect, reduce the frequency and duration of door openings.
	Door is not closing properly.	Refer to the Doors will not close correctly or pop open section in the Troubleshooting section.
Refrigerator or Freezer section is too cold.	Incorrect temperature control settings.	If the temperature is too cold, adjust the control one increment at a time and wait for the temperature to stabilize. Refer to the Setting the Controls section for more information.

Problem	Possible Causes	Solutions
Frost or ice crystals on frozen food (inside of sealed package).	Condensation from food with a high water content has frozen inside of the food package.	This is normal for food items with a high water content.
	Food has been left in the freezer for a long period of time.	Do not store food items with high water content in the freezer for a long period of time.
Clicking	The defrost control will click when the automatic defrost cycle begins and ends. The thermostat control (or refrigerator control on some models) will also click when cycling on and off.	Normal Operation
Rattling	Rattling noises may come from the flow of refrigerant, the water line on the back of the unit, or items stored on top of or around the refrigerator.	Normal Operation
	Refrigerator is not resting solidly on the floor.	Floor is weak or uneven or leveling legs need to be adjusted. See the Door Alignment section.
	Refrigerator with linear compressor was jarred while running.	Normal Operation
Whooshing	Evaporator fan motor is circulating air through the refrigerator and freezer compartments.	Normal Operation
	Air is being forced over the condenser by the condenser fan.	Normal Operation
Gurgling	Refrigerant flowing through the cooling system.	Normal Operation
Popping	Contraction and expansion of the inside walls due to changes in temperature.	Normal Operation
Sizzling	Water dripping on the defrost heater during a defrost cycle.	Normal Operation
Vibrating	If the side or back of the refrigerator is touching a cabinet or wall, some of the normal vibrations may make an audible sound.	To eliminate the noise, make sure that the sides and back cannot vibrate against any wall or cabinet.
Dripping	Water running into the drain pan during the defrost cycle.	Normal Operation

Problem	Possible Causes	Solutions
Pulsating or High-Pitched Sound	Your refrigerator is designed to run more efficiently to keep your food items at the desired temperature. The high efficiency compressor may cause your new refrigerator to run longer than your old one, but it is still more energy efficient than previous models. While the refrigerator is running, it is normal to hear a pulsating or high-pitched sound.	Normal Operation
Doors will not close correctly or pop open.	Food packages are blocking the door open.	Rearrange food containers to clear the door and door shelves.
	Ice bin, crisper cover, pans, shelves, door bins, or baskets are out of position.	Push bins all the way in and put crisper cover, pans, shelves and baskets into their correct positions. See the Using Your Refrigerator section for more information.
	The doors were removed during product installation and not properly replaced.	Remove and replace the doors according to the Removing and Replacing Refrigerator Handles and Doors section.
	Refrigerator is not leveled properly.	See Door Alignment in the Height adjustment section to level refrigerator.
Doors are difficult to open.	The gaskets are dirty or sticky.	Clean the gaskets and the surfaces that they touch. Rub a thin coat of appliance polish or kitchen wax on the gaskets after cleaning.
	Door was recently closed.	When you open the door, warmer air enters the refrigerator. As the warm air cools, it can create a vacuum. If the door is hard to open, wait one minute to allow the air pressure to equalize, then see if it opens more easily.
Refrigerator wobbles or seems unstable.	Leveling legs are not adjusted properly.	Refer to the Leveling and Door Alignment section.
	Floor is not level.	It may be necessary to add shims under the leveling legs or rollers to complete installation.
Lights do not work.	LED interior lighting failure.	The refrigerator compartment lamp is LED interior lighting, and service should be performed by a qualified technician.
Refrigerator has an unusual odor.	The Pure N Fresh filter may need to be set to the POWER setting or replaced.	Set the Pure N Fresh filter to the POWER setting. If the odor does not go away within 24 hours, the filter may need to be replaced. See the Replacing the Pure N Fresh filter section for replacement instructions.
The interior of the refrigerator is covered with dust or soot.	The refrigerator is located near a fire source, such as a fireplace, chimney or candle.	Make sure that the refrigerator is not located near a fire source, such as a fireplace, chimney, heater or candle.

