

Model	VC2216***/VC2216****/VC2316***/VC2316*****/VC3316***/VC3316****		
Language	English		
Page	16	Color(cover/body)	1/1
Material	Weight	Size(W*H)	150×220(mm)
Date	2012.12.30	Designer	D.K.HUNG
PartNo	MFL67722412	Description	Owners Manual

### ChageRecord

No.	Change content	ECO No.	Date	Designer	Confirm
①					
②					
③					
④					
⑤					
⑥					
⑦					
⑧					
⑨					



**LG**

Life's Good

ENGLISH

## OWNER'S MANUAL

# NEW TYPE CYCLONE VACUUM CLEANER

This information contains important instructions for the safe use and maintenance of the vacuum cleaner. Especially, please read all of the information on page 5-8 for your safety. Please keep this manual in an easily accessible place and refer to it anytime.

VC2216\*\*\*

VC2216\*\*\*\*

VC2316\*\*\*

VC2316\*\*\*\*

VC3316\*\*\*

VC3316\*\*\*\*



MF L 6 7 7 2 2 4 1 2

[www.lg.com](http://www.lg.com)

## Basic Parts

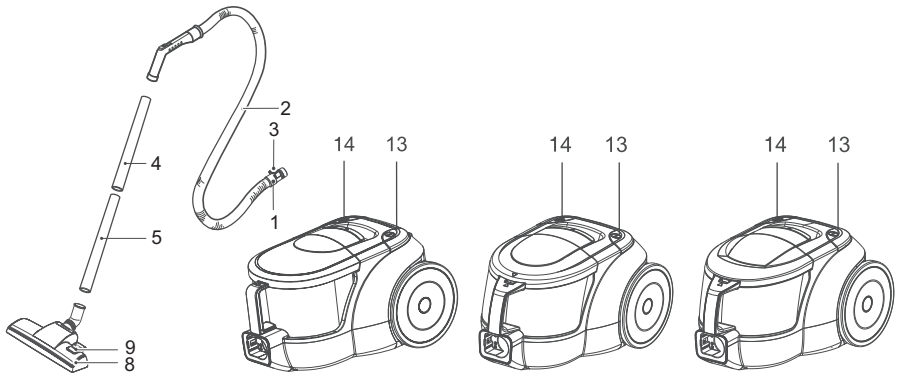

## Optional Parts

■ The different figure and quantity of the following parts depend on the different models which you have bought.

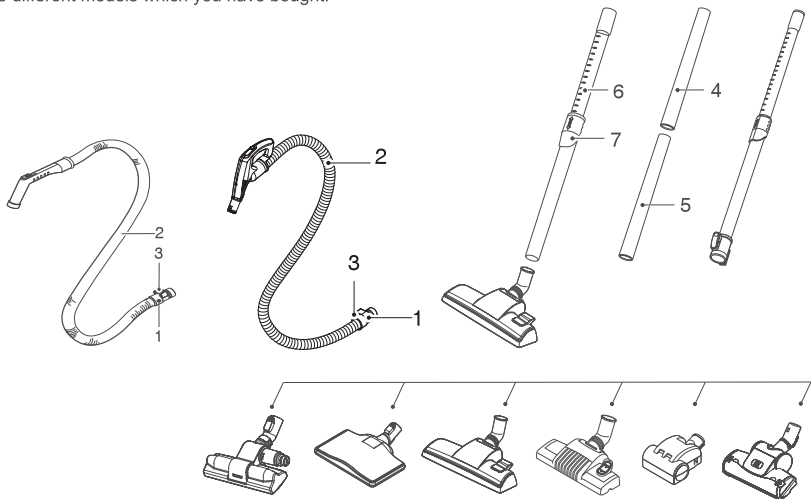

## Accessory

■ These specifications are subject to change according to the agent/buyer's request.



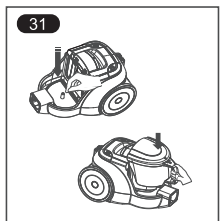
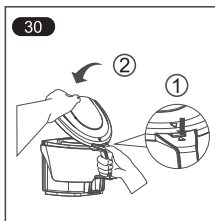
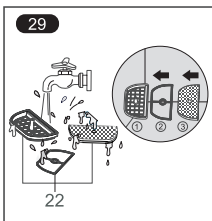
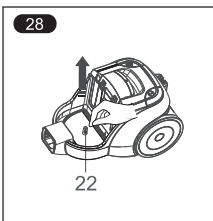
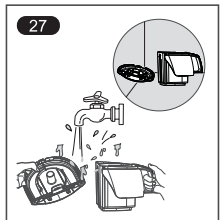
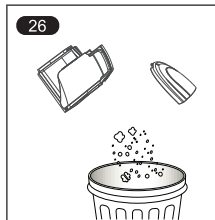
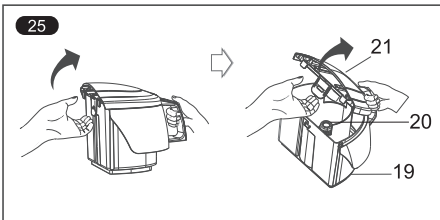
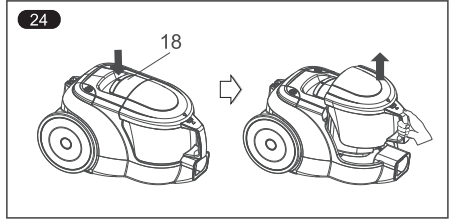
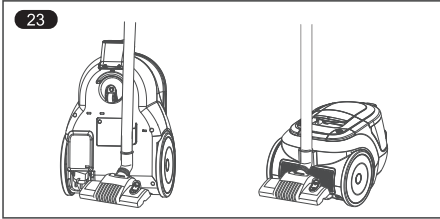
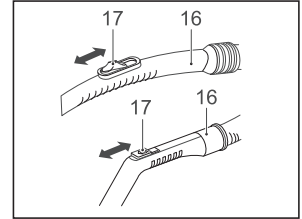
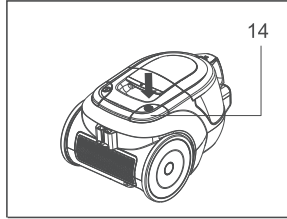
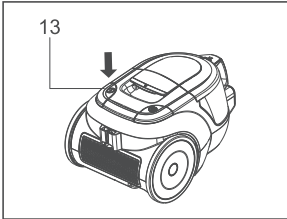
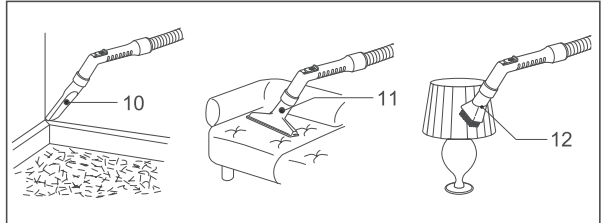
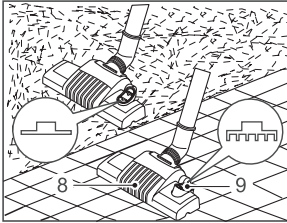
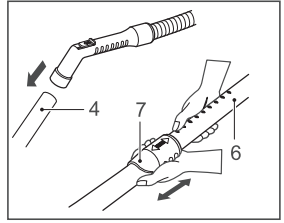
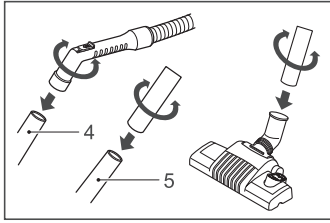
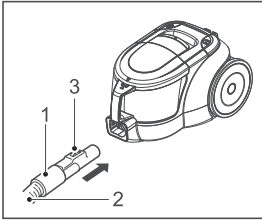

32

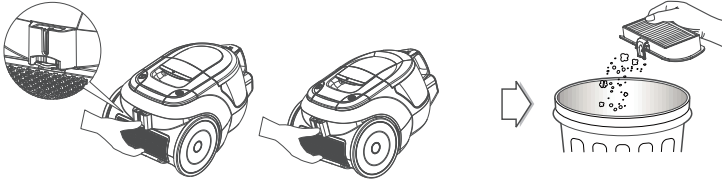

### Optional Parts

33

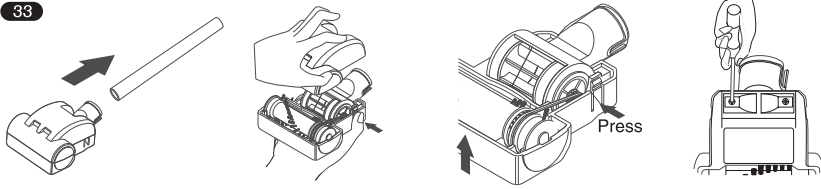

34

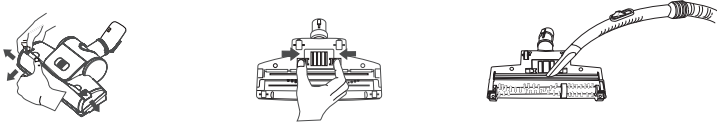

35

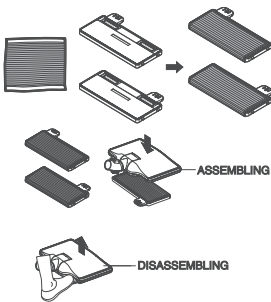

36

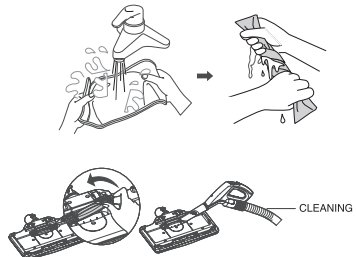

37

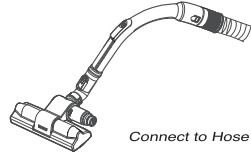
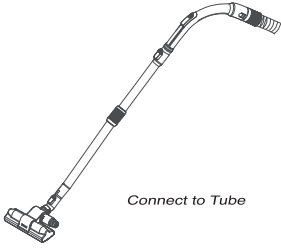

38

• bed, bedding, heavy blanket

• Light blanket & sheet

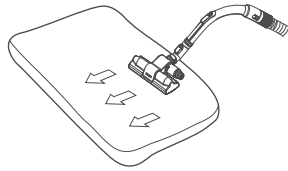
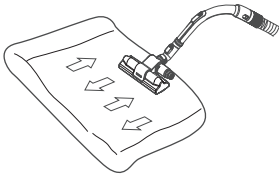

39

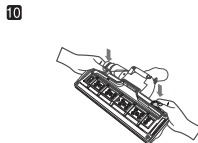
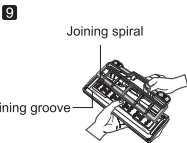
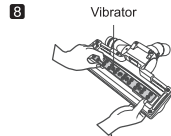
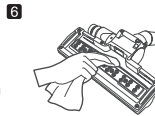
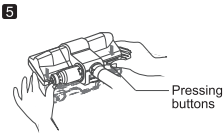
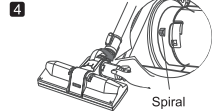
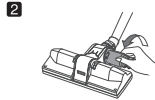
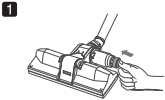

40

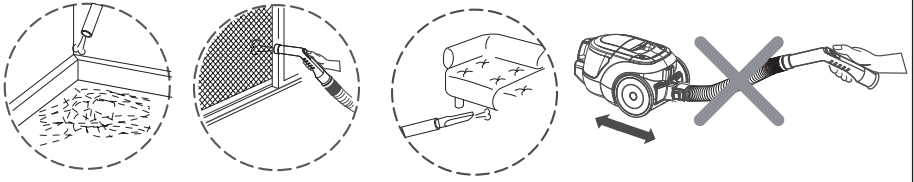

When using the function of fanning, removal of the exhaust filter and cover. And then, fix up the blower cover.

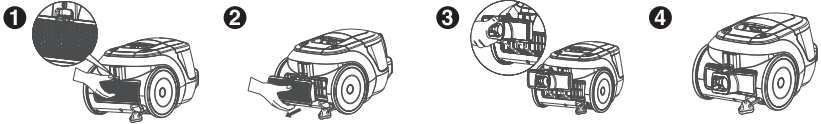

41

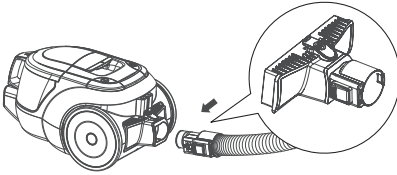

42

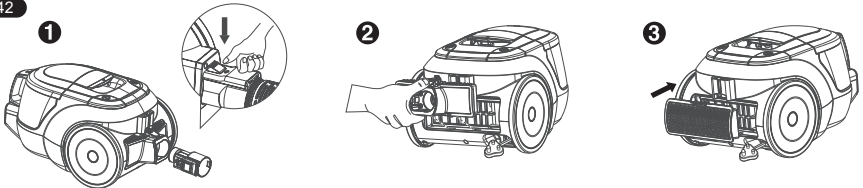

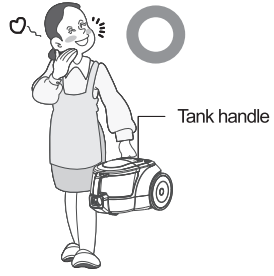
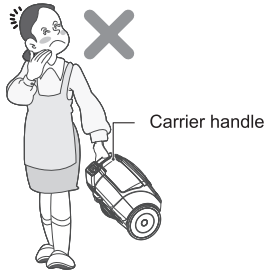



# IMPORTANT SAFETY INSTRUCTIONS

Read and follow all instructions before using your vacuum cleaner to prevent the risk of fire, electric shock, personal injury, or damage when using the vacuum cleaner. This guide does not cover all possible conditions that may occur. Always contact your service agent or manufacturer about problems that you do not understand. This appliance complies with the following ECDirectives:-2006/95/EC Low Voltage Directive-2004/108/EC EMC Directive.

ENGLISH



This is the safety alert symbol.

This symbol alerts you to potential hazards that can kill or hurt you and others.

All safety messages will follow the safety alert symbol and either the word "WARNING" or "CAUTION." These words mean:



**WARNING**

This symbol will alert you to hazards or unsafe practices which could cause serious bodily harm or death.



**CAUTION**

This symbol will alert you to hazards or unsafe practices which could cause bodily injury or property damage.



**WARNING**

- **Do not use the vacuum cleaner if the power cord or plug is damaged or faulty.**

If the power cord is damaged, it must be replaced by an approved LG Electronics Service Agent to avoid a hazard.

- **This appliance is not intended for use by persons (including children) with reduced physical, sensory or mental capabilities, or lack of experience and knowledge, unless they have been given supervision or instruction concerning use of the appliance by a person responsible for their safety.**

Children should be supervised to ensure that they do not play with the appliance.

- **This appliance can be used by children aged from 8 years and above and persons with reduced physical, sensory or mental capabilities or lack of experience and knowledge if they have been given**

 **WARNING**

**supervision or instruction concerning use of the appliance in a safe way and understand the hazards involved. Children shall not play with the appliance. Cleaning and user maintenance shall not be made by children without supervision.**

- **Disconnect electrical supply before servicing or cleaning the unit or when cleaner is not in use.**  
Failure to do so could result in electrical shock or personal injury.
- **Do not vacuum liquid, blade, gesso, substances, or small particles like cement, burning or smoking such as cigarettes, or hot ashes in cleaning.**
- **Do not vacuum flammable or explosive substances such as gasoline, benzene, thinners, propane (liquids or gases).**  
The fumes from these substances can create a fire hazard or explosion. Doing so could result in death or personal injury.
- **Do not handle plug or vacuum cleaner with wet hands.**  
Doing so could result in death or electrical shock.
- **Do not unplug by pulling on cord.**  
Doing so could result in product damage or electrical shock. To unplug, grasp the plug, not the cord.
- **Keep hair, loose clothing, fingers, and all parts of the body away from openings and moving parts.**  
Failure to do so could result in electrical shock or personal injury.
- **Do not pull or carry by cord, use cord as a handle, close a door on cord, or pull cord around sharp edges or corners. Do not run vacuum cleaner over cord. Keep cord away from heated surfaces.**  
Failure to do so could result in electrical shock or personal injury or fire or product damage.
- **Do not allow to be used as toy. Close attention is necessary when used by or near children.**  
Personal injury or product damage could result.
- **Do not use vacuum cleaner if it has been under water.**  
Personal injury or product damage could result. In these cases, contact LG Electronics Service Agent to avoid hazard.
- **Do not continue to vacuum if any parts appear missing or damaged.**  
Personal injury or product damage could result. In these cases, contact LG Electronics Service Agent to avoid hazard.
- **Do not use an extension cord with this vacuum cleaner**  
Fire hazard or product damage could result.
- **Using proper voltage.**  
Using improper voltage may result in damage to the motor and possible injury to the user. Proper voltage is listed on the bottom of vacuum cleaner.
- **Turn off all controls before unplugging.**  
Failure to do so could result in electrical shock or personal injury.
- **Do not change the plug in any way.**  
Failure to do so could result in electrical shock or personal injury or product damage. Doing so result in death. If plug does not fit, contact a qualified electrician to install the proper outlet.
- **Repairs to electrical appliances may only be performed by qualified service engineers.**  
Improper repairs may lead to serious hazards for the user.
- **Do not plug in if control knob is not in OFF position.**  
Personal injury or product damage could result. (Depending on model)

# IMPORTANT SAFETY INSTRUCTIONS



## WARNING

- **Keep children away and beware of obstructions when rewinding the cord to prevent personal injury.**

The cord moves rapidly when rewinding.  
(Depending on model)

- **The hose contains electrical wires. Do not use it if it is damaged, cut or punctured.**

Failure to do so could result in death, or electrical shock. (Depending on model)



## CAUTION

- **Do not put any objects into openings.**  
Failure to do so could result in product damage.

- **Do not use with any opening blocked: keep free of dust, lint, hair, and anything that may reduce air flow.**

Failure to do so could result in product damage.

- **Do not use vacuum cleaner without dust tank and/or filters in place.**

Failure to do so could result in product damage.

- **Do not use vacuum cleaner to pick up sharp hard objects, small toys, pins, paper clips, etc.**

They may damage the cleaner or dust bin.

- **Store the vacuum cleaner indoors.**

Put the vacuum cleaner away after use to prevent tripping over it.

- **Only use parts produced or recommended by LG Electronics Service Agents.**

Failure to do so could result in product damage.

- **Use only as described in this manual. Use only with LG recommended or approved attachments and accessories.**

Failure to do so could result in personal injury or product damage.

- **To avoid personal injury and to prevent the machine from falling when cleaning stairs, always place it at the bottom of stairs.**

Failure to do so could result in personal injury or product damage.

- **Use accessory nozzles in sofa mode.**  
Failure to do so could result in product damage.

- **Make sure the filters (exhaust filter and motor safety filter) are completely dry before replacing in the machine.**

Failure to do so could result in product damage.

- **Do not dry the filter in an oven or microwave.**

Failure to do so could result in fire hazard.

- **Do not dry the filter in a clothes dryer.**

Failure to do so could result in fire hazard.

- **Do not dry near an open flame.**

Failure to do so could result in fire hazard.

- **Always clean the dust bin after vacuuming carpet cleaners or fresheners, powders and fine dust.**

These products clog the filters, reduce airflow and can cause damage to the cleaner. Failure to clean the dust bin could cause permanent damage to the cleaner. (Depending on model)

- **Don't grasp the tank handle when you are moving the vacuum cleaner.**

The vacuum cleaner's body may fall when separating tank and body. Personal injury or product damage could result. **You should grasp the carrier handle** when you are moving the vacuum cleaner. (Depending on model)

## IMPORTANT SAFETY INSTRUCTIONS

### CAUTION

- **When you are using the Blower Function, don't pull the hose forcibly.**

The Blower may fall off from cleaner when you pull the hose forcibly. Please move the cleaner and hose together.

LG vacuum cleaner comes with unique Blower attachment for your convenience. High air flow rate motor gives you the desired blowing effect to clean the hard-to-reach location & crevices.

#### **Thermal protector :**

This vacuum cleaner has a special thermo stat that protects the vacuum cleaner in case of motor overheating. If the vacuum cleaner suddenly shuts off, turn off the switch and unplug the vacuum cleaner. Check the vacuum cleaner for possible source of overheating such as a full dust tank, a blocked hose or clogged filter. If these conditions are found, fix them and wait at least 30 minutes before attempting to use the vacuum cleaner. After the 30 minute period, plug the vacuum cleaner back in and turn on the switch.

## How to Use

### Connecting the flexible hose

Push the end of the head (1) on the flexible hose (2) into the attachment point on the vacuum cleaner.

To remove the flexible hose from the vacuum cleaner, push the button (3) situated on the head, then pull upwards.

### Assembling the tubes

(depending on model)

- **Metal tube (4,5)**
  - Fit together the two tubes by twisting slightly.
- **Telescopic tube (6)**
  - Push spring latch (7).
  - Pull out tube to required length.
  - Release spring latch to lock.

### Using the cleaning head and Accessory Nozzles (depending on model)

Fit the large cleaning head onto the end of the tube.

- **The 2 position head (8)** is equipped with a pedal (9) which allows you to alter its position according to the type of floor to be cleaned.  
**Hard floor position** (tiles, parquet floors...): Push the pedal to lower the brush.  
**Carpet or rug position:** Push the pedal to lift the brush up.

- **Crevice Tool (10)**

For vacuuming in those normally inaccessible places i.e. reaching cobwebs, or down the side of a sofa!

- **Upholstery Nozzle (11)**

For vacuuming upholstery, mattresses, etc. The thread collectors help to pick up the threads and fluff.

- **Dusting brush (12)**

For vacuuming picture frames furniture outlines, books and other uneven objects.

### How to plug in and use

Pull out the mains lead to the desired length and plug into the socket.

Push the button (13) to start the vacuum cleaner. To stop it press the button (13) again.



**No liquid suction.**

**Liquid suction can cause defect.**

### Adjusting the power level

(depending on model)

- The flexible hose handle (16) has a manual air flow regulator (17) which allows you to briefly reduce the suction level.

### Parking and storage (23)

When you have switched off and unplugged the appliance, push the button (14) to automatically rewind the cord.

Slide the hook on the nozzle into the slot on the side of vacuum cleaner. You can store your vacuum cleaner in a vertical position by sliding the hook on the nozzle into the slot on the underside of the vacuum cleaner.

### Raising the dust tank (24)

After turning off appliance and unplug it, push the button (18) and hold the tank handle, then raise the tank .

### Opening the dust tank (25)

Please pull the hook (21) behind the tank, then open the tank cover.

### Emptying the dust tank

As below, if these things happen to your vacuum cleaner, please turn off the appliance, unplug it and remove hose. Take out the dust tank (24) and motor safety filter (22) from the cleaner. Then empty the dust tank (26) and clean the motor safety filter (22).

- When the dust in the tank (19) reaches the maximum line.
- When a great deal of dust has clogged up the inner cover (20).
- When the motor safety filter (22) is full of dust. Wash the dust tank (27) with cold water. Dry fully in shade so that moisture is removed entirely.



**If after emptying the dust tank the suction is low, clean the motor safety filter.**

Failure to do so could result in product damage.

## **Closing the dust tank**

According to the arrow's direction(30) on the top of tank handle, please take the hook into the hole on the handle and close the dust tank by locking the hook behind it.

## **Cleaning the motor safety filter**

The motor safety filter is situated inside the appliance under the dust tank. Each time that you clean the motor safety filter, we advise you to take out the motor safety filter(28).

Wash it with cold water (29) and dry fully in shade so that moisture is removed entirely. And then place it again in the vacuum cleaner. The motor safety filter should be cleaned at least once a month.

**⚠ Dry fully for more than 24 hours in shade.**

## **Fixing the dust tank**

According to the arrow's direction(31), please close the dust tank correctly and then put it in the vacuum cleaner.

**⚠ Do not use vacuum cleaner without motor safety filter.**

Failure to do so could result in motor damage and weak suction.

## **Cleaning exhaust filter(32)**

- The exhaust filter is a reusable HEPA filter (depend on model).
- To clean the exhaust filter, remove it on the body by releasing hook.
- Dust off filter. (Do not wash filter with water)
- The exhaust filter should be cleaned at least once a year.

## **Mini turbine nozzle (optional)(33)**

- Mini turbine is used for stairs and other hard to reach places.
- To clean the mini turbine nozzle, remove the nozzle cover:  
Remove 2 screws on the bottom and take mini turbine nozzle cover off as shown.

- Frequently clean and remove hair, string, and lint build-up in the brush area.

Failure to do so could damage to mini turbine nozzle.

## **Turbine Nozzle (depending on model)(34)**

- **Cleaning turbine brush nozzle.**
- Press the button on the rear side of the nozzle to separate the air cover.
- Use the dusting brush & crevice tool to vacuum clean the brush and fan.

## **Mop nozzle (depending on model)**

**If you do not completely remove the moisture when using the microfiber cloth, it can cause electric shock and damage the main unit.**

The integrated microfiber mop removes fine grit and dust quickly after vacuuming. When the microfiber cloth is attached on the cloth board, make sure soak the microfiber cloth under water and twist completely.

Microfiber cloth board can be used both sides.

Reuse the dirty cloth by cleaning it with clean water, soap, detergent etc. and then by completely drying the cloth in the shade.

## User's Guide for Sani Punch(depend on model)(37~39)

Use it as shown in the diagram

Effective cleaning (38)

- To increase cleaning efficiency for light blankets, lay on top of a bulky blanket and then clean Cleaning Sani Punch  
warning:The vibrator may break down due to the cleansing of the inhaler with water
- If the dust settles in the box while cleaning, press the button 2 or 3 times. (It will remove most of the dust). **1**
- After the cleaning, if there are lots of dusts in the box, separate the box from the inhaler by turning it anticlockwise. **2**
- Empty the box. **3**
- Aim at the Spiral, Fix the box into the inhaler by turning it clockwise. **4**
- Separate the bottom plate by pressing the buttons in the back. **5**
- Clean the dirty body of the inhaler carefully with a cloth. **6**
- Wash the separated bottom plate and dry it in the shade. **7**
- Arrange the vibrator in order. **8**
- Insert the joining spiral into the groove. **9**
- Attach the bottom plate properly by pressing down. **10**

## How to use Blower Function

### Blower application areas (40)

Behind wall cabinets, heavy cupboards refrigerators and the corners of rooms,net and mesh on windows.

### Attach hose to Blower (41)

Connect hose to Blower In right direction, and don't rotate hose when you're using the Blower Function!

### Remove Blower (42)

Remove the hose (1)  
Remove the blower (2)  
Assemble exhaust filter (3)

## What to do if your appliance does not work ?

Check that the appliance is correctly plugged in and that the electrical socket is working.

## What to do when the suction performance reduces?

- Stop the appliance and unplug it.
- Check that the tubes, flexible hose and cleaning tool are not blocked.
- Check dust in the tank does not reach the maximum line. Empty the dust tank if necessary.
- Check that the inner cover (**20**) is not clogged, Clean up it if necessary.
- Check that the motor safety filter (**22**) is not full of dust. Clean up it if necessary.

# WARRANTY

This LG Vacuum Cleaner comes with 12 months warranty, from the date of purchase against defective material or workman ship subject to following terms & conditions. In case of a defect, LG Electronics India Limited undertakes to get the set repaired free of charge.

## INSTRUCTIONS FOR THE CUSTOMER

1. This warranty card has 2 parts. Kindly ensure that the dealer fills all parts correctly.
2. Part A is the customer's copy. It should be retained by you for record.
3. Part B must be torn and mailed to the nearest LG ELECTRONICS BRANCH OFFICES listed in this booklet. If not, please tell the dealer to keep Part B for collection.
4. In the event of a defect developing in the product, contact the authorized LG Electronics Service Centre, for obtaining warranty service and inform him of the defect ,Model No. & SI.No.

## TERMS AND CONDITIONS

1. Repairs & Replacements will be carried out though authorized LG Electronics Service Centres.
2. For Units installed beyond the municipal limits of the jurisdiction of the authorize LG Electronics Service Centres, all expenses incurred in collecting the units or parts there of, as well as expenses incurred with deputizing of service personnel/technicians towards conveyance and other incidentals etc. will be borne by the customer.
3. Components subject to wear, such as carbon brushes and Plastic part &/or accessories are not covered by this Warranty.
4. While the company will make every effort to carry out repairs at the earliest, it however is made expressly clear that the company is under no obligation to do so in a specified period of time.
5. The company or its authorized LG Electronics Service Centres reserves the right to retain any part(s) or components replaced at its discretion, in the event of a defect being noticed in the equipment during the warranty period.
6. Warranty does not cover accessories external to the equipment supplied by the dealer.

	<b>CUSTOMER COPY</b>	<b>PART A</b>
MODEL NO.:	DATE OF PURCHASE:	
UNIT Sr.No.:		
<div style="border-bottom: 1px solid black; margin-bottom: 5px;">CUSTOMER NAME &amp; ADDRESS</div> <div style="border-bottom: 1px solid black; margin-bottom: 5px;"></div> <div style="border-bottom: 1px solid black; margin-bottom: 5px;"></div> <div>TEL. _____</div>	<div style="border-bottom: 1px solid black; margin-bottom: 5px;">DEALER NAME &amp; ADDRESS</div> <div style="border-bottom: 1px solid black; margin-bottom: 5px;"></div> <div style="border-bottom: 1px solid black; margin-bottom: 5px;"></div> <div>TEL. _____</div>	
Customer's Signature		Dealer's Signature

This card is valid only if it is filled in and stamped by our authorized dealer on the date of purchase.

### **Warranty voids if:**

1. The warranty card is not completed properly at the time of purchase.
2. The completed warranty card is not presented to authorized personnel at the time of service of the product.
3. The Vacuum Cleaner is not operated according to instructions given in the "Owner's Manual" booklet.
4. Defects are caused by improper or reckless use, which shall determined by company personnel.
5. Any repair work is carried out by persons other than authorized company personnel.
6. Defects are caused due to causes beyond control like lightning, abnormal vottage, acts of God or while in transit to service centre or purchaser's residence.
7. The warranty is not valid in case, the Serial Number is deleted, defected or altered.

	<b>COMPANY COPY</b>	<b>PART B</b>
MODEL NO.:	DATE OF PURCHASE:	
UNIT Sr.No.:		
<div style="border-bottom: 1px solid black; margin-bottom: 5px;">CUSTOMER NAME &amp; ADDRESS</div> <div style="border-bottom: 1px solid black; margin-bottom: 5px;"></div> <div style="border-bottom: 1px solid black; margin-bottom: 5px;"></div> <div>TEL. _____</div>	<div style="border-bottom: 1px solid black; margin-bottom: 5px;">DEALER NAME &amp; ADDRESS</div> <div style="border-bottom: 1px solid black; margin-bottom: 5px;"></div> <div style="border-bottom: 1px solid black; margin-bottom: 5px;"></div> <div>TEL. _____</div>	
Customer's Signature		Dealer's Signature

This card is valid only if it is filled in and stamped by our authorized dealer on the date of purchase.

 **LG Electronics**





 **LG** **24 x 7** CALL CENTER

 <b>CALL</b>	<b>1800-180-9999</b> (Toll Free)	 <b>SMS</b>	<b>5757554</b> (Send SMS)
 <b>CLICK</b>	<b>www.lg.com</b> <b>serviceindia@lge.com</b>		

---

		<b>www.facebook.com/lifegoodpage</b> <b>www.twitter.com/LGIndiaTweets</b>
---	---	--