



ENGLISH

OWNER'S MANUAL

WIRELESS SPEAKER

Please read this manual carefully before operating your set and retain it for future reference.

NP6630



MFL67884242

www.lg.com

Safety Information



CAUTION: TO REDUCE THE RISK OF ELECTRIC SHOCK DO NOT REMOVE COVER (OR BACK) NO USER-SERVICEABLE PARTS INSIDE REFER SERVICING TO QUALIFIED SERVICE PERSONNEL.



This lightning flash with arrowhead symbol within an equilateral triangle is intended to alert the user to the presence of uninsulated dangerous voltage within the product's enclosure that may be of sufficient magnitude to constitute a risk of electric shock to persons.



The exclamation point within an equilateral triangle is intended to alert the user to the presence of important operating and maintenance (servicing) instructions in the literature accompanying the product.

WARNING: This product contains chemicals known to the State of California to cause cancer and birth defects or other reproductive harm. ***Wash hands after handling.***

WARNING: TO PREVENT FIRE OR ELECTRIC SHOCK HAZARD, DO NOT EXPOSE THIS PRODUCT TO RAIN OR MOISTURE.

WARNING: Do not install this equipment in a confined space such as a book case or similar unit.

NOTICE: For safety marking information including product identification and supply ratings, please refer to the main label on the bottom of the apparatus.

CAUTION concerning the Power Cord

Most appliances recommend they be placed upon a dedicated circuit;

That is, a single outlet circuit which powers only that appliance and has no additional outlets or branch circuits. Check the specification page of this owner's manual to be certain. Do not overload wall outlets. Overloaded wall outlets, loose or damaged wall outlets, extension cords, frayed power cords, or damaged or cracked wire insulation are dangerous. Any of these conditions could result in electric shock or fire. Periodically examine the cord of your appliance, and if its appearance indicates damage or deterioration, unplug it, discontinue use of the appliance, and have the cord replaced with an exact replacement part by an authorized service center. Protect the power cord from physical or mechanical abuse, such as being twisted, kinked, pinched, closed in a door, or walked upon. Pay particular attention to plugs, wall outlets, and the point where the cord exits the appliance. To disconnect power from the mains, pull out the mains cord plug. When installing the product, ensure that the plug is easily accessible.

This device is equipped with a portable battery or accumulator.

Safety way to remove the battery or the battery from the equipment: Remove the old battery or battery pack, follow the steps in reverse order than the assembly. To prevent contamination of the environment and bring on possible threat to human and animal health, the old battery or the battery put it in the appropriate container at designated collection points. Do not dispose of batteries or battery together with other waste. It is recommended that you use local, free reimbursement systems batteries and accumulators. The battery shall not be exposed to excessive heat such as sunshine, fire or the like.

CAUTION:

- The apparatus should not be exposed to water (dripping or splashing) and no objects filled with liquids, such as vases, should be placed on the apparatus.
- No naked flame sources, such as lighted candles, should be placed on the apparatus.
- Internal lithium battery in the unit should not be replaced by user because of danger of explosion if battery is incorrectly replaced, and must be replaced with the same type battery by expert.
- Only use the AC adapter supplied with this device. Do not use a power supply from another device or another manufacturer. Using any other power cable or power supply may cause damage to the device and void your warranty.
- To avoid fire or electric shock, do not open the unit. contact to qualified personnel only.
- Do not leave the unit in a place near the heating appliances or subject to direct sunlight, moisture, or mechanical shock.
- To clean the unit, use a soft, dry cloth. If the surfaces are extremely dirty, use a soft cloth lightly moistened with a mild detergent solution. Do not use strong solvents such as alcohol, benzine, or thinner, as these might damage the surface of the unit.
- Do not use volatile liquids such as insecticide spray near the unit. Wiping with strong pressure may damage the surface. Do not leave rubber or plastic products in contact with the unit for a long period of time.
- Do not place the unit over the vehicle's air bag. When the air bag deploys, it may result in injury. Before using in the car, fix the unit.
- Do not use the handsfree function during driving a car.
- Do not leave the unit on an unstable place such as high shelves. It may fall down because of the vibration of the sound.

FCC Compliance Statement

This device complies with part 15 of the FCC rules. Operation is subject to the following two conditions:

- (1) This device may not cause harmful interference, and
- (2) This device must accept any interference received, including interference that may cause undesired operation.

NOTE: This equipment has been tested and found to comply with the limits for a Class B digital device, pursuant to Part 15 of the FCC Rules. These limits are designed to provide reasonable protection against harmful interference in a residential installation. This equipment generates, uses, and can radiate radio frequency energy and, if not installed and used in accordance with the instructions, may cause harmful interference to radio communications. However, there is no guarantee that interference will not occur in a particular installation.

If this equipment does cause harmful interference to radio or television reception, which can be determined by turning the equipment off and on, the user is encouraged to try to correct the interference by one or more of the following measures:

- Reorient or relocate the receiving antenna.
- Increase the separation between the equipment and receiver.
- Connect the equipment into an outlet on a circuit different from that to which the receiver is connected.
- Consult the dealer or an experienced radio/TV technician for help.

CAUTION: Any changes or modifications not expressly approved by the party responsible for compliance could void the user's authority to operate this equipment.

FCC RF Radiation Exposure Statement : This equipment complies with FCC radiation exposure limits set forth for an uncontrolled environment. This equipment should be installed and operated with minimum distance 20 cm between the radiator and your body. End users must follow the specific operating instructions for satisfying RF exposure compliance. This transmitter must not be co-located or operating in conjunction with any other antenna or transmitter.

CAUTION: Regulations of the FCC and FAA prohibit airborne operation of radio-frequency wireless devices because their signals could interfere with critical aircraft instruments.

Responsible Party :

LG Electronics USA, Inc. 1000 Sylvan Avenue
Englewood Cliffs, NJ 07632

TEL. : +1-800-243-0000

IMPORTANT SAFETY INSTRUCTIONS

1. Read these instructions.
2. Keep these instructions.
3. Heed all warnings.
4. Follow all instructions.
5. Do not use this apparatus near water.
6. Clean only with dry cloth.
7. Do not block any ventilation openings. Install in accordance with the manufacturer's instructions.
8. Do not install near any heat sources such as radiators, heat registers, stoves, or other apparatus (including amplifiers) that produce heat.
9. Do not defeat the safety purpose of the polarized or grounding-type plug. A polarized plug has two blades with one wider than the other. A grounding type plug has two blades and a third grounding prong. The wide blade or the third prong are provided for your safety. If the provided plug does not fit into your outlet, consult an electrician for replacement of the obsolete outlet.
10. Protect the power cord from being walked on or pinched particularly at plugs, convenience receptacles, and the point where they exit from the apparatus.
11. Only use attachments/accessories specified by the manufacturer.
12. Use only with the cart, stand, tripod, bracket, or table specified by the manufacturer, or sold with the apparatus. When a cart is used, use caution when moving the cart/apparatus combination to avoid injury from tip-over.
13. Unplug this apparatus during lightning storms or when unused for long periods of time.
14. Refer all servicing to qualified service personnel. Servicing is required when the apparatus has been damaged in any way, such as power-supply cord or plug is damaged, liquid has been spilled or objects have fallen into the apparatus, the apparatus has been exposed to rain or moisture, does not operate normally, or has been dropped.



Table of Contents

1 Getting Started

- 2 Safety Information
- 6 Main Features
 - 6 – LG Bluetooth Remote
- 6 Accessories
- 6 Introduction
- 7 Main Unit
- 8 Charging the Unit
 - 8 – Connecting the AC adapter
 - 8 – Checking the charging status
 - 8 – Battery protection



2 Operating

- 9 Basic Operations
 - 9 – Using power button
 - 9 – Using volume button
- 9 Listening to Music from Your External Device
 - 10 – About ferrite core (Optional)
- 10 Using a Bluetooth Wireless Technology
 - 10 – Listening to music of a bluetooth device
 - 12 – Using bluetooth app
- 14 Using AirPlay
 - 15 – Connecting AirPlay-enabled device
 - 17 – Streaming audio from your iTunes music library to this unit
- 19 Other Operations
 - 19 – Using handsfree function
 - 19 – Auto power down
 - 19 – LG Tag On
 - 20 – LG Sound Sync

3 Troubleshooting

- 21 Troubleshooting
 - 21 – General

4 Appendix

- 22 About  /  Button's Condition
- 23 Trademarks and Licenses
- 23 Handling the Unit
- 24 Specifications

1

2

3

4

Main Features

Made for iPod/iPhone/iPad or Android device

Enjoys music from iPod/iPhone/iPad or Android device with simple connection.

Portable In

Listens to music from your portable device.

LG Sound Sync

Controls volume level of this unit by the remote control of your LG TV that is compatible with LG Sound Sync.

AirPlay®

Listens to music stored on your Apple device.

LG Bluetooth Remote

You can control this unit with your iPod touch/iPhone/iPad or Android device via Bluetooth. This unit and your device must be paired for Bluetooth. Visit "Apple App Store" or "Google Android Market (Google Play Store)" or use the QR code shown below to search for "LG Bluetooth Remote" app. For detailed information, refer to page 12.



(Apple iOS)



(Android OS)

Accessories

Please check and identify the supplied accessories.

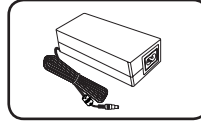

AC adapter (1)

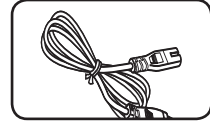

Power cord (1)

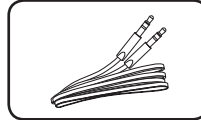

Portable Cable (1)

Introduction

Symbol used in this manual

! Note

Indicates special notes and operating features.

⚠ Caution

Indicates cautions for preventing possible damages from abuse.

Main Unit

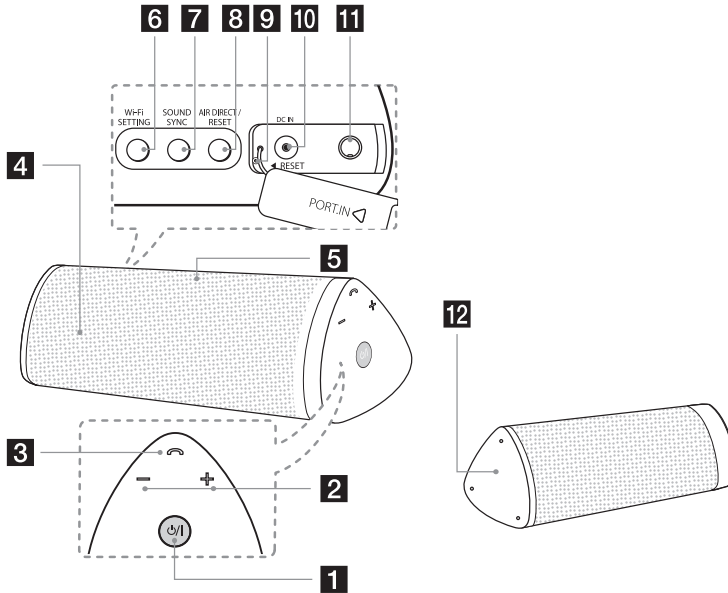

1 / I

- Turns on / off : Press and hold / I
- Selects the function and input source.

2 +/- (Volume) : Adjusts speaker volume.

3 Phone button

4 Speaker

5 Microphone

6 Wi-Fi SETTING:

Connects your unit to the existing Wi-Fi network.

7 SOUND SYNC

Synchronizes this unit and your LG TV.

8 AIR DIRECT / RESET

- Creates new Wi-Fi network with your unit.
- Initializes Wi-Fi network's security mode.

9 Reset hole

10 DC IN (AC adapter input)

11 PORT.IN (3.5 mm)

Listens to music from your portable device.

12 NFC Tag (page 19)

Caution

Precautions in using the touch buttons

- Use the touch buttons with clean and dry hands. - In a humid environment, wipe out any moisture on the touch buttons before using.
- Do not press the touch buttons hard to make it work. - If you apply too much strength, it can damage the sensor of the touch buttons.
- Touch the button that you want to work in order to operate the function correctly.
- Be careful not to have any conductive material such as metallic object on the touch buttons. It can cause malfunctions.

Charging the Unit

Connecting the AC adapter

This device uses built-in battery. Before using it, charge the battery by connecting the AC Adapter.

1. Connect the supplied AC power cord to the AC adapter.
2. Connect the AC adapter cable to DC IN adapter input.
3. Plug the AC power cord into an AC outlet.

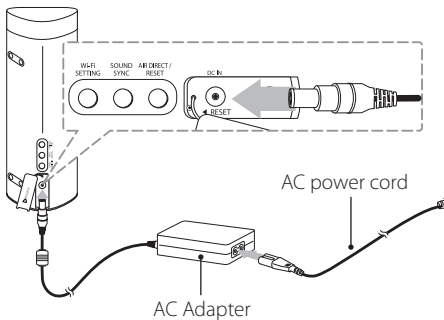

Caution

Only use the AC adapter supplied with this device. Do not use a power supply from another device or manufacturer. Using any other power cable or power supply may cause damage to the device and void your warranty.

Checking the charging status

When AC Adapter is connected, battery charging is started. You can check the charging status with **⏻/⏻** button. (Refer to the page 22 for details)

- Charging : The **⏻/⏻** button blinks red or white.
- Fully charged : The **⏻/⏻** button turns red or white.

Note



- Deactivate AirPlay feature
Operating time is approx. 10 hours. (Based on 30 % volume, 1 kHz signal, 500 mV portable input and fully charged status)
- Activate AirPlay feature
Operating time is approx. 5 hours. (Based on 30 % volume, 1 kHz signal, 500 mV portable input and fully charged status)

It may vary depending on the battery status and operational conditions.

Battery protection

When AC Adapter is connected, if the unit is in high or low temperature, there may be a problem with the battery. So the unit has the battery protection feature. (refer to table as below.)

In this case, use the unit in proper place where the temperature or humidity is not so high or low.

Battery temperature : Very low		
Power Off	 (Red) (White)	Warning
Battery temperature : Very High		
Power On	 (Red) (White) (Off)	Blinks 10 sec

Basic Operations

Using power button

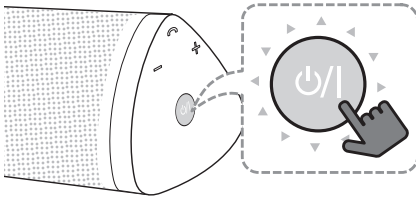

Power On

Activate AirPlay feature

Press and hold the button.

Deactivate AirPlay feature

Press and hold down the **AIR DIRECT / RESET** button first, followed by the button.

! Note

When Airplay feature is set to off, power consumption will be lower than when Airplay is set to on.

Power Off

Press and hold the button.

Changing the mode

When turning on the unit, you can change the mode. Please button repeatedly, the mode is changed with the voice sound.

Activate AirPlay feature

(Portable In -> AirPlay -> bluetooth -> Portable In)

Deactivate AirPlay feature

(Portable In -> bluetooth -> Portable In)

! Note

You can enjoy the Sound Sync feature by pressing SOUND SYNC button. Refer to page 20

Using volume button

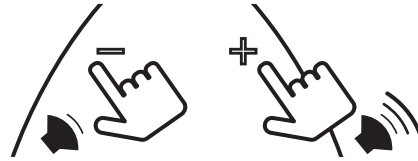

You can adjust speaker volume. When you touch the volume button, the button blinks twice in white color.

! Note

While adjusting volume if you try to increase the volume when it is already at maximum level, a beep is played on the unit.

Listening to Music from Your External Device

The unit can be used to listen to the music from many types of external device.

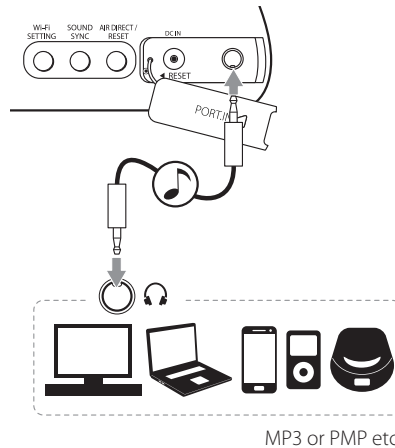

1. Connect the external device to the **PORT.IN** connector of the unit.
2. Turn the power on by pressing button.
3. Press button repeatedly to select portable in mode.
4. Turn the external device on and start playing.

About ferrite core (Optional)

This ferrite core can reduce noises.

How to attach the ferrite core

1. Pull the stopper [a] of the ferrite core to open.
2. Wind the portable cable on the ferrite core.
3. Close the ferrite core until it clicks.

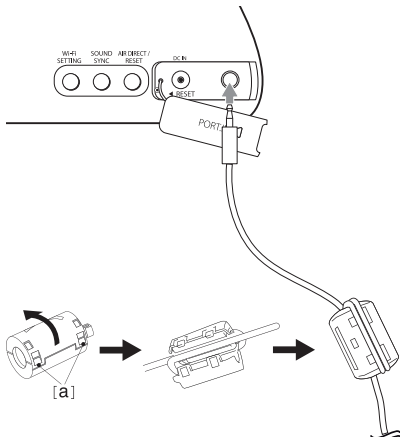

2

Operating

Using a Bluetooth Wireless Technology

About Bluetooth

Bluetooth® is wireless communication technology for short range connection.

The available range is within 10 meters.

(The sound may be interrupted when the connection interfered by the other electronic wave or you connect the bluetooth in the other rooms.)

Connecting individual devices under **Bluetooth®** wireless technology does not incur any charges. A mobile phone with **Bluetooth®** wireless technology can be operated via the Cascade if the connection was made via **Bluetooth®** wireless technology.

Available Devices : Mobile phone, MP3, Laptop, PDA.

Bluetooth profiles

In order to use Bluetooth wireless technology, devices must be able to interpret certain profiles. This unit is compatible with following profile.

A2DP (Advanced Audio Distribution Profile)

Listening to music of a bluetooth device

Before you start the pairing procedure, make sure the Bluetooth feature is turned on in to your Bluetooth device. Refer to your Bluetooth device's user guide. Once a pairing operation is performed, it does not need to be performed again.

1. Select the Bluetooth function by pressing the  button repeatedly.
2. Operate the Bluetooth device and perform the pairing operation. When searching for this unit with the Bluetooth device, a list of the devices found may appear in the Bluetooth device display depending on the type of Bluetooth device. Your unit appears as "LG Portable (XX:XX)".

Note

XX:XX means the last four digits of BT address. For example, if your unit has a BT address such as 9C:02:98:4A:F7:08, you will see "LG Portable (F7:08)" on your Bluetooth device.

3. Enter the PIN code.
PIN code : 0000

Note

Depending on the Bluetooth device type, some devices do not require a PIN code.

4. When this unit successfully is connected with your Bluetooth device, the  button blinks twice in white color.

Note

- Depending on the Bluetooth device type, some devices have a different pairing way.
- Try pairing procedure if your device name is not in the device list.

5. Listen to music.
To play a music stored on your Bluetooth device, refer to your Bluetooth device's user guide. According to your Bluetooth device's volume level, the volume level of Bluetooth will be adjusted.

Note

- Sound from the unit can be distorted if you raise the volume of Bluetooth device up to two-thirds or more.
- When you use the Bluetooth function, adjust the volume of a Bluetooth device to a proper level to listen to.

Note

- On portable in mode, After your device is connected to the unit via Bluetooth, the function switches to Bluetooth mode automatically.
- After searching for this unit on your Bluetooth device, connect the Bluetooth device to this unit. Then play music you want.
- The sound may be interrupted when the connection interfered by the other electronic wave.
- You cannot control the Bluetooth device with this unit.
- Pairing is limited one Bluetooth device per one unit and multi-pairing is not supported.
- Although the distance between your Bluetooth and the set is less than 10 m, there are obstacles between both, your Bluetooth device cannot be connected.
- Depending on the type of the device, you may not be able to use the Bluetooth function.
- You can enjoy wireless system using phone, MP3, Notebook, etc.
- The electrical malfunction due to devices using same frequency such as Medical equipment, Microwaves or wireless LAN devices, the connection will be disconnected.
- When someone stands and interrupts communication between Bluetooth device and the player, the connection will be disconnected.
- If the gotten away of the distance between Bluetooth and the unit, the sound quality is lower and lower. The connection will disconnect when the space between the Bluetooth and the unit gets out of the operating range of Bluetooth.
- The device with Bluetooth wireless technology is disconnected, if you turn off the main unit or put the device away from the main unit more than 10 m.
- If the Bluetooth device is disconnected, you should connect the Bluetooth device to your unit.

Using bluetooth app

About "LG Bluetooth Remote" app

"LG Bluetooth Remote" app brings a suite of new features to this unit.

To enjoy more features, you are recommended to download and install free "LG Bluetooth Remote" app.

Install "LG Bluetooth Remote" app through "Apple App Store" or "Google Android Market (Google Play Store)"

1. Tap the "Apple App Store" icon or "Google Android Market (Google Play Store)" icon.
2. In the search bar, type in the "LG Bluetooth Remote" and search it.
3. In the search result list, find and tap "LG Bluetooth Remote" to start downloading Bluetooth app.
4. Tap an icon for installation.
5. Tap an icon for downloading.

! Note

- Make sure that your Bluetooth device is connected to the Internet.
- Make sure that your Bluetooth device is equipped with "Apple App Store" or "Google Android Market (Google Play Store)".
- If you want to get more information, refer to explanation of BT app in "Apple App Store" or "Google Android Market (Google Play Store)".

Install "LG Bluetooth Remote" app by using QR code

1. Install "LG Bluetooth Remote" app through QR code. Use the scanning software to scan the QR code.



(Apple iOS)



(Android OS)

2. Tap an icon for installation.
3. Tap an icon for downloading.

! Note

- Make sure that your Bluetooth device is connected to the Internet.
- Make sure that your Bluetooth device has a scanning software application. If you don't have one, download one from "Apple App Store" or "Google Android Market (Google Play Store)".

Activate bluetooth with “LG Bluetooth Remote” app

“LG Bluetooth Remote” app helps to connect your bluetooth device to this unit.

! Note

In case of iOS device ;
After performing the pairing operation,
activate Bluetooth with LG Bluetooth Remote App.

1. Tap “LG Bluetooth Remote” app icon on the home screen to open “LG Bluetooth Remote” app, and go to the main menu.
2. Tap [Setting] and select the unit you want.
3. If you want to get more information to operate, tap [Setting] and [Help].

! Note

- BT app will be available in the software version as follow;
Android O/S : Ver 2.3.3 (or later)
iOS O/S : Ver 4.3 (or later)
- This unit does not support the multi-pairing. If this unit is already connected with other Bluetooth device, disconnect that device and then try again.
- Depending on the Bluetooth device, “LG Bluetooth Remote” app may not work.
- “LG Bluetooth Remote” app for Apple iOS is slightly different from that of Android OS.
- The connection you’ve made may be disconnected if you select other application or change the setting of the connected device via “LG Bluetooth Remote” app. In such a case, please check the connection status.
- To prevent a malfunction, you are recommended to connect only one device to this unit.
- After connection of BT app, music may be output from your device. In this case, try connecting procedure again.

Using AirPlay

Apple AirPlay technology enables you to play your iTunes music library, hosted on a Mac, PC, iPhone, iPod touch, or iPad on any AirPlay-enabled device connected to the Wi-Fi network.

To stream audio wirelessly by AirPlay, you need :

	Air Direct	Webpage
Compatible Apple Device	iPad mini, iPad4, iPad3, iPad2, iPad, iPhone5, iPhone 4S, iPhone 4, iPhone 3GS, iPod touch 5G, iPod touch 4G, iPod touch 3G	
iOS Version	Ver.4.3.3 (or later)	
iTune Version	Ver.10.2.2 (or later)	
Wireless LAN (internal antenna)	802.11 b/g	
Security Mode	WEP with Open / Shared mode	WPA(TKIP/AES) WPA2(TKIP/AES) WEP with Open mode
Webpage address	192.168.1.1 (Optional for security)	192.168.1.111

- This unit should be connected to the same local network as your iTunes host device through the Wi-Fi router.
- Depending on the operating system or the application's version and the setting status of AirPlay-enabled device connected to this unit, AirPlay may not be operated normally.
- Depending on the Network environment and your device state, it may take long time to connect the unit.
- To prevent a malfunction, you are recommended to connect only one device to this unit.

Compatible iPod/iPhone/iPad models

iPhone 5, iPhone 4S, iPhone 4, iPhone 3GS, iPad (3rd and 4th generation), iPad 2, iPad, iPad mini, iPod touch (3rd through 5th generation),

AirPlay, iPad, iPhone, iPod nano, and iPod touch are trademarks of Apple Inc., registered in the U.S. and other countries. Lightning is a trademark of Apple Inc.

Connecting AirPlay-enabled device

Option 1 : Using Air Direct

On Unit

1. Press **⏻/||** button repeatedly on the unit to select **AirPlay** function.
2. Press **AIR DIRECT / RESET** on the unit. Then **⏻/||** button blinks with white and amber color alternately. Then it stops blinking and stays in amber color with beep sound. (about **⏻/||** button, refer to page 22)

On AirPlay-enabled device

3. Turn on the Wi-Fi function on AirPlay-enabled device.



4. In the network list, find and select "LG AIR DIRECT XXXXXX".

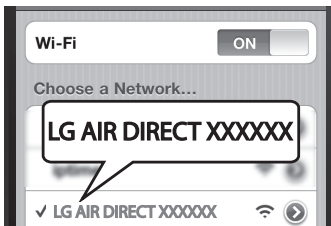

5. Use AirPlay after your iPod touch/iPhone/iPad or PC/MAC is connected.

! Note

- If "LG AIR DIRECT XXXXXX" is not in the list, try to scan the available Wi-Fi networks again.
- When your iPod touch/iPhone/iPad or PC/MAC is connected to "LG AIR DIRECT XXXXXX", you cannot use internet.

Using Air Direct with Security mode

6. Launch Apple Safari browser or Microsoft Internet Explorer browser on your iPod touch/iPhone/iPad or PC/MAC.
7. Type in "192.168.1.1" at the browser address bar and confirm.
8. Set security mode and insert password.
 - hexadecimal (0-9, A-F) 10 or 26 digits.
 - 5 or 13 ASCII characters.
9. Tap or click "OK"



10. In the network list, find and select "LG AIR DIRECT XXXXXX" again.



11. If you want to get back to non-security mode, select security type as None.

! Note

- If you want to deactivate Air Direct function, press **AIR DIRECT / RESET**.
- If you want to initialize Wi-Fi network's Security Mode, press and hold **AIR DIRECT / RESET**.
- When you disconnect Air Direct, this unit will automatically attempt to reconnect webpage it has last accessed.

Option 2 : Using webpage

The new Wi-Fi network created by this unit only allows access of one Wi-Fi enabled device. To avoid interference from any other Wi-Fi devices, you are recommended to temporarily disable the Wi-Fi function on your other Wi-Fi devices.

! Note

- "LG AUDIO Setup XXXXXX" is the temporary and assistant Wi-Fi network for connection of this unit to your home Wi-Fi router.
- While your iPod touch/iPhone/iPad or your Wi-Fi enabled PC/Mac is connecting to "LG AUDIO Setup XXXXXX" network, you can not use Internet.

On Unit

1. Press **⏻/|** button repeatedly on the unit to select **AirPlay** function.
2. Press **Wi-Fi SETTING**. **⏻/|** button will blink with white and amber color alternately.

On AirPlay-enabled device

3. After 20 seconds, select "LG AUDIO Setup XXXXXX" in the network list on your iPod/iPhone/iPad or PC/MAC. **⏻/|** button will blink quickly with white and amber color alternately.

! Note

- If "LG AUDIO Setup XXXXXX" is not in the list, try to scan the available Wi-Fi networks again.
- If you want to deactivate Webpage function, press **Wi-Fi SETTING**.
- In case of pressing **Wi-Fi SETTING** on other function, the unit goes to AirPlay function. You check the status through **⏻/|** button.
- When this network connection is unstable, initialize the network by pressing **AIR DIRECT / RESET**.

4. Launch Apple Safari browser or Microsoft Internet Explorer browser on your iPod touch/iPhone/iPad or PC/MAC.
5. Type in "192.168.1.111" at the browser address bar and confirm.
6. Select your network name (SSID) from "Wireless Network".
7. Enter the network key if required.
8. Tap or click "OK" to proceed with network settings change.
 - Follow the on-screen instructions to change and confirm the internal Wi-Fi settings of this unit.
 - Please wait about 30 seconds and more.

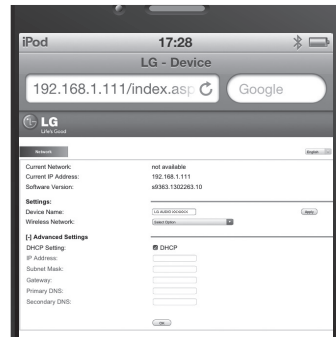

9. If this unit is connected to your selected home Wi-Fi network successfully, **⏻/|** button stops blinking and stays in white color. (about **⏻/|** button, refer to page 22)
10. If you have security on your access point, you need to input the security code as necessary.

! Note

- If you use other characters than the English alphabet or digits for the SSID name of your access point or wireless router, it may be displayed differently.
- WEP security mode generally have 4 keys available on an access point setting. If your access point or wireless router use WEP security, enter the security code of the key "No.1" to connect on your home network.
- An Access Point is a device that allows you to connect to your home network wirelessly.

Streaming audio from your iTunes music library to this unit

! Note

Make sure that your iTunes host device is connected to the same Wi-Fi network as this unit. Your iTunes device can be an iPod touch/iPhone/iPad installed with iOS 4.3.3 (or later) or a Wi-Fi enabled PC/Mac installed with iTunes 10.2.2 (or later).

2

Operating

Stream from your iPod touch/iPhone/iPad

1. Launch the "Music" application on your iPod touch/iPhone/iPad.



2. Tap on the AirPlay icon .

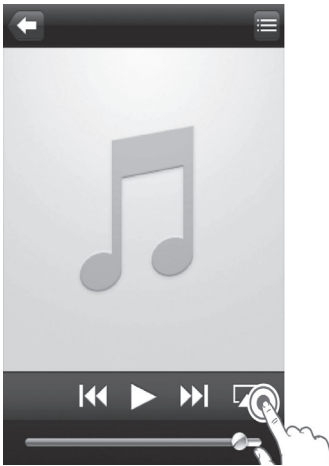

3. Select "LG AUDIO XXXXX" (or user customized name) from the AirPlay list.

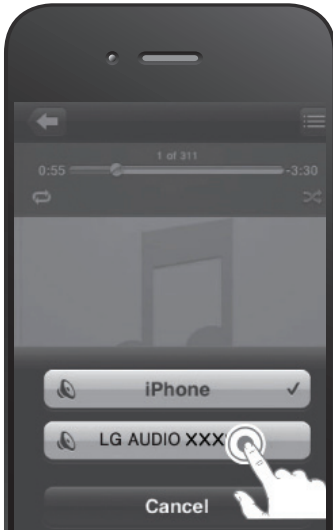

4. Select a media file and start play.
- After a while, you will hear music from this unit.
 - Depending on your connection environment and network condition, audio output may not be normal.

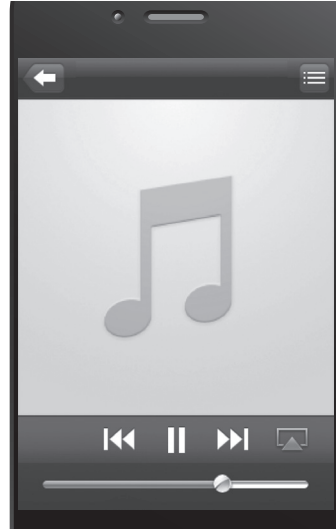

! Note

- If you fail to hear music after successful setup, do one of the following on your iPod touch/iPhone/iPad:
 - Disconnect and then re-connect to the same Wi-Fi router again.
 - Close all applications running at the background.
 - Power off and then power on your iPod touch/iPhone/iPad again.
- To prevent a malfunction, you are recommended to connect only one device to this unit.

Other Operations

Using handsfree function



Preparation: Your smartphone must be paired with the unit via bluetooth.

1. When a call comes in, press  to receive the phone.

Note

- While listening to music, if incoming calls, the music pauses automatically. Then the unit and your smartphone ring at the same time.
- Depending on the type of bluetooth-enabled phone or surrounding environment, the sound quality may be lowered or the unit may not work properly.

2. You can select the desired option by using  button, refer to below.

Condition	Press 	Press and Hold 
Incoming Call	Answer Call	Reject Call
During Call	Hang Up	Switch Call from unit to Phone

Auto power down

This unit will be off itself to save electronic consumption in the case main unit is not connected to external device and is not used for 25 minutes.

Also this unit will power down if no input is connected using the analogue input after six hours.

LG Tag On

LG Tag On allows you to install and open "LG Bluetooth Remote" app to NFC-enabled phone.

1. Activates the NFC feature of your NFC-enabled phone.
2. Turn on the unit.
3. Tag the back of your NFC-enabled phone over the unit.

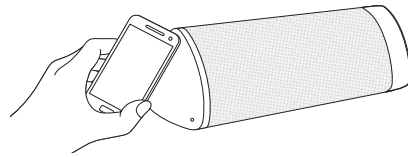

- If "LG Bluetooth Remote" app is not installed on your NFC-enabled phone, the linked screen with "LG Bluetooth Remote" app is displayed.
- If "LG Bluetooth Remote" app is installed on your NFC-enabled phone, "LG Bluetooth Remote" app is activated and Bluetooth is connected automatically.

Note

- You must activate the NFC feature of your NFC-enabled phone.
- If your NFC-enabled phone's screen is locked, it will not read the NFC.
- If your smart phone case is plated with chrome, NFC is unavailable. Depending on your case's material or thickness, NFC may not be read well.

LG Sound Sync



You can control some functions of this unit by your TV's remote control with LG Sound Sync. It is compatible with the LG TV that is supported LG Sound Sync. Make sure of the LG Sound Sync logo on your TV.

Controllable function by LG TV's remote control :
Volume up/down, mute

Refer to the TV's instruction manual for the details of LG Sound Sync.

! Note

- When the connections failed, make sure of the condition of the TV and power of it.
- Make sure of the condition of this unit and the connection in the cases below when using LG Sound Sync.
 - Turned off the unit.
 - Changing the function to the others.
 - Disconnecting the wireless connection caused by interference or a distance.

With wireless connection

1. Turn on the unit.
2. Press **SOUND SYNC** to select the LG Sound Sync function. button will stay in Green color.
3. Set up LG Sound Sync (Wireless) on the TV. Refer to the TV's instruction manual.
4. When this unit successfully is connected with your LG TV, the button blinks twice in Green color.



If your unit and LG TV are connected normally, button will blink or stop blinking depending on battery condition. (Refer to "Battery" on page 22)

! Note

- Once LG TV function is selected, the unit connects automatically the TV which is connected lately when restarting.
- The device with Bluetooth wireless technology will be disconnected, if Sound Sync function is selected. Bluetooth remote app you've already connected is disconnected either.
- In LG Sound Sync function, you can search and connect this unit through LG TV only.
- In LG Sound Sync function, the volume step of this unit will be changed to the volume step of LG TV.

Troubleshooting

General

Problem	Cause & Correction
No Power.	<ul style="list-style-type: none"> • The battery is discharged. Recharge the battery. • Connect the unit to the power supply with the AC adapter
No sound or sound distortion	<ul style="list-style-type: none"> • The unit or your smart device's volume is set to minimum. Check and adjust the volume of the unit or bluetooth device's volume. • When you use an external device at high volume, the sound quality may be deteriorated. Lower the volume of the devices. • If you use the unit for purposes other than listening to music, the sound quality may be lowered or the unit may not work properly.
Bluetooth pairing does not work well.	<ul style="list-style-type: none"> • Switch bluetooth off and on again on your bluetooth device, then try pairing again. • Be sure your bluetooth device is on. • Remove the obstacle in the path of the bluetooth device and the unit. • Depending on the type of the bluetooth device or surrounding environment, your device may not be paired with the unit. • While using Bluetooth, you may not activate BT app. Disconnect Bluetooth device you have connected before to use BT app properly. • When your Bluetooth device have been already connected with other unit, disconnect the Bluetooth connection first. Then you can control your unit through BT app. • Depending on the Bluetooth device, BT app may work restrictively not work. • The connection you've made may be disconnected if you select other application or change the setting of the connected device via BT app. In such case, please check the connection status.
Connecting AirPlay does not work well.	<ul style="list-style-type: none"> • Press and hold AIR DIRECT / RESET on the unit to initialize.
The unit does not operate normally.	<ul style="list-style-type: none"> • In case of malfunction,  /  button is lit in red and white alternately. Please use the unit in proper place where the temperature or humidity is not so high or low.
Above solutions do not work.	<ul style="list-style-type: none"> • Press Reset hole with a pointed thing like mechanical pencil.

About / Button's Condition



Turned on white



Turned on red



Turned on amber or green













Turned off



Beep Sound















Battery

Power	AC Adapter	Condition	Color	
Off	Connected	Charging → Full charge	 ↔  → 	
On	Disconnected	Low battery	 ↔ 	Blinks quickly
On	Connected	Charging → Full charge	 ↔  → 	
-	Connected	Has a problem with the battery	 ↔ 	Warning message





Bluetooth

Power	AC Adapter	Condition	Color	
On	-	Bluetooth paired	 ↔  + 	Blinks twice

AirPlay

Power	AC Adapter	Condition	Color	
On	-	Waiting for connection (On AirPlay mode)	(Amber)  ↔  +  Beep : when disconnecting Air Direct	Blinks slowly
On	-	Connecting (Searching AirPlay-enabled device)	(Amber)  ↔ 	
On	-	Connecting (Searched AirPlay-enabled device)	(Amber)  ↔ 	Blinks Quickly
On	Disconnected	AirPlay connected	(Amber)  + 	
On	Connected	AirPlay connected / Charging → Full charge	 ↔  →  + 	
On	-	AirPlay resetting	(Amber)  ↔ 	Blinks quickly (3 sec)

LG Sound Sync

Power	AC Adapter	Condition	Color	
On	-	Sound Sync disconnected (On Sound Sync mode)	(Green) 	
On	-	Sound Sync connected	(Green)  ↔  + 	Blinks twice

Trademarks and Licenses



Bluetooth® wireless technology is a system which allows radio contact between electronic devices within a max. range of 10 meters.

Connecting individual devices under *Bluetooth*® wireless technology does not incur any charges. A mobile phone with *Bluetooth*® wireless technology can be operated via the Cascade if the connection was made via *Bluetooth*® wireless technology.

The *Bluetooth*® word mark and logos are owned by the *Bluetooth*® SIG, Inc. and any use of such marks by LG Electronics is under license.

Other trademarks and trade names are those of their respective owners.



The Wi-Fi CERTIFIED Logo is a certification mark of the Wi-Fi Alliance.

Handling the Unit

When shipping the unit

Please save the original shipping carton and packing materials. If you need to ship the unit, for maximum protection, re-pack the unit as it was originally packed at the factory.

Keeping the exterior surfaces clean

- Do not use volatile liquids such as insecticide spray near the unit.
- Wiping with strong pressure may damage the surface.
- Do not leave rubber or plastic products in contact with the unit for a long period of time.

Cleaning the unit

To clean the player, use a soft, dry cloth. If the surfaces are extremely dirty, use a soft cloth lightly moistened with a mild detergent solution. Do not use strong solvents such as alcohol, benzine, or thinner, as these might damage the surface of the unit.

Specifications

General	
Power requirements	DC 12 V  1.5 A
AC adapter requirements	100 - 240 V, 50 / 60 Hz
Power consumption	18 W
Dimensions (W x H x D)	300 mm x 95 mm x 98 mm (11.8" x 3.7" x 3.9")
Net Weight (Approx.)	1.37 kg
Operating temperature	5 °C to 35 °C (41 °F to 95 °F)
Operating humidity	5 % to 60 %

Inputs	
PORT. IN	0.5 Vrms (3.5 mm stereo jack)

Amplifier	
Output Power (Adapter)	10 W x 2 ch (6 Ω at 1 kHz)
Output Power (Battery)	5 W x 2 ch (6 Ω at 1 kHz)
T.H.D	10 %

Speakers	
Type	built-in
Impedance Rated	6 Ω
Rated Input Power	10 W
Max Input Power	20 W

- Design and specifications are subject to change without notice.



LG Customer Information Center

1-800-243-0000 USA, Consumer
1-888-865-3026 USA, Commercial

Register your product Online!

www.lg.com

Printed in Indonesia