



LG

Life's Good

ENGLISH

OWNER'S MANUAL

Music in Style

Wireless Speaker With Dual Dock

Please read this manual carefully before operating your set and retain it for future reference.

ND8630



MFL6786913

Safety Information



CAUTION: TO REDUCE THE RISK OF ELECTRIC SHOCK DO NOT REMOVE COVER (OR BACK) NO USER-SERVICEABLE PARTS INSIDE REFER SERVICING TO QUALIFIED SERVICE PERSONNEL.



This lightning flash with arrowhead symbol within an equilateral triangle is intended to alert the user to the presence of uninsulated dangerous voltage within the product's enclosure that may be of sufficient magnitude to constitute a risk of electric shock to persons.



The exclamation point within an equilateral triangle is intended to alert the user to the presence of important operating and maintenance (servicing) instructions in the literature accompanying the product.

WARNING: TO PREVENT FIRE OR ELECTRIC SHOCK HAZARD, DO NOT EXPOSE THIS PRODUCT TO RAIN OR MOISTURE.

WARNING: Do not install this equipment in a confined space such as a book case or similar unit.

NOTICE: For safety marking information including product identification and supply ratings, please refer to the main label on the bottom of the apparatus.

CAUTION concerning the Power Cord

Most appliances recommend they be placed upon a dedicated circuit;

That is, a single outlet circuit which powers only that appliance and has no additional outlets or branch circuits. Check the specification page of this owner's manual to be certain. Do not overload wall outlets. Overloaded wall outlets, loose or damaged wall outlets, extension cords, frayed power cords, or damaged or cracked wire insulation are dangerous. Any of these conditions could result in electric shock or fire. Periodically examine the cord of your appliance, and if its appearance indicates damage or deterioration, unplug it, discontinue use of the appliance, and have the cord replaced with an exact replacement part by an authorized service centre. Protect the power cord from physical or mechanical abuse, such as being twisted, kinked, pinched, closed in a door, or walked upon. Pay particular attention to plugs, wall outlets, and the point where the cord exits the appliance. To disconnect power from the mains, pull out the mains cord plug. When installing the product, ensure that the plug is easily accessible.

This device is equipped with a portable battery or accumulator.

Safety way to remove the battery or the battery from the equipment: Remove the old battery or battery pack, follow the steps in reverse order than the assembly. To prevent contamination of the environment and bring on possible threat to human and animal health, the old battery or the battery put it in the appropriate container at designated collection points. Do not dispose of batteries or battery together with other waste. It is recommended that you use local, free reimbursement systems batteries and accumulators. The battery shall not be exposed to excessive heat such as sunshine, fire or the like.

CAUTION:

- The apparatus shall not be exposed to water (dripping or splashing) and no objects filled with liquids, such as vases, shall be placed on the apparatus.
- No naked flame sources, such as lighted candles, should be placed on the apparatus.
- Only use the AC adaptor supplied with this device. Do not use a power supply from another device or another manufacturer. Using any other power cable or power supply may cause damage to the device and void your warranty.
- To avoid fire or electric shock, do not open the unit. contact to qualified personnel only.
- Do not leave the unit in a place near the heating appliances or subject to direct sunlight, moisture, or mechanical shock.
- Do not leave the unit on an unstable place such as high shelves. It may fall down because of the vibration of the sound.

- The appliance is not intended for use by young children or infirm persons without supervision.
- Young Children should be supervised to ensure that they do not play with appliance.
- If the appliance is supplied from a cord extension set or an electrical portable outlet device, the cord extension set on electrical portable outlet device must be positioned so that it is not subject to splashing or ingress of moisture.

Table of Contents

1 Getting Started

- 2 Safety Information
- 6 Main Features
- 6 Accessories
- 6 Introduction
- 7 Remote Control
- 8 Front Panel
- 10 Back Panel
- 11 Connecting the AC Adapter
- 11 About Ferrite Core (Optional)

2 Operating

- 12 Basic Operations
 - 12 - iPod/iPhone/iPad Operation
 - 13 - Compatible iPod/iPhone/iPad
 - 14 - Android device Operation
 - 15 - Listening to Music from Your External Device
- 16 Using a Bluetooth Wireless Technology
 - 16 - Listening to Music of a Bluetooth Device
 - 18 - Using Bluetooth App
- 20 Using AirPlay
 - 21 - Connecting your Wi-Fi device to Wi-Fi network
 - 24 - Streaming audio from your iTunes music library to this unit
- 26 Other Operations
 - 26 - LG Tag On
 - 26 - LG Sound Sync
 - 27 - Setting BASS (BASS BLAST) sound effect
 - 27 - Turning Off the Sound Temporarily
 - 27 - Adjusting the brightness of the lighting
 - 27 - Auto Power Down

3 Troubleshooting

- 28 Troubleshooting

4 Appendix

- 29 About LED condition
- 30 Trademarks and Licenses
- 30 Handling the Unit
- 31 Specifications

1

2

3

4

Main Features

Made for iPod/iPhone/iPad or Android device

Enjoys music from iPod/iPhone/iPad or Android device with simple connection.

Portable In

Listens to music from your portable device.

LG Sound Sync

Controls volume level of this unit by the remote control of your LG TV that is compatible with LG Sound Sync.

AirPlay®

Listens to music stored on your Apple device.

LG Bluetooth Remote

You can control this unit with your iPod touch/iPhone/iPad or Android device via Bluetooth. This unit and your device must be paired for Bluetooth. Visit "Apple App Store" or "Google Android Market (Google Play Store)" or use the QR code shown below to search for "LG Bluetooth Remote" app. For detailed information, refer to page 18-19.



(Apple iOS)



(Android OS)

Accessories

Please check and identify the supplied accessories.

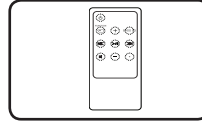

Remote control (1)

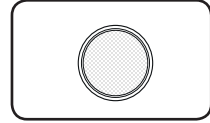

Battery (1)

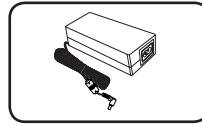

AC adapter (1)

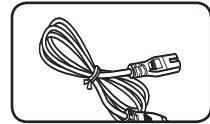

Power cord (1)

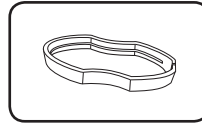

Tweezers (1)

Introduction

Symbol Used in This Manual

! Note

Indicates special notes and operating features.

⚠ Caution

Indicates cautions for preventing possible damages from abuse.

Remote Control

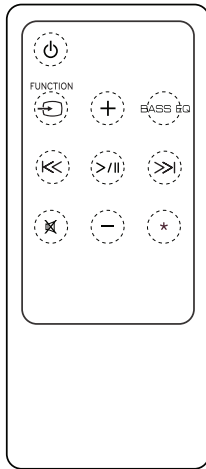

- (Power): Switches the unit ON or OFF.
- FUNCTION**: Selects the function and input source. (LG Sound Sync function is only selected by using the **SOUND SYNC** button on the rear of the unit.)
- BASS EQ**: Reinforce BASS (BASS BLAST) sound effect.
- I<</>>I** (Skip/Search):
 - Skips fast Backward or Forward.
 - Searches for a section within a file.
- >||** (Play/Pause): Starts or pause playback
- : Mutes the sound.
- ***: The button is not available for any function.

Caution

The battery used in this device may present a fire or chemical burn hazard if mistreated. Do not recharge, disassemble, incinerate, or heat above 100 °C (212 °F). Replace the battery part no. CR2025 only. Use of another battery may present a risk of fire or explosion. Dispose of used battery. Keep battery away from children. Do not disassemble or dispose of in fire.

Battery Installation

You have two ways to open the battery cover.

1. Turn the battery cover counterclockwise by using a coin or your finger. Then take the battery cover.

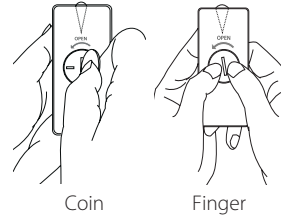

Coin

Finger

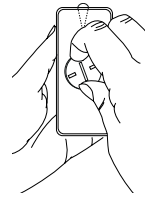

2. Insert and fix the battery with the plus (+) facing in the same direction as the plus (+) on the battery cover.

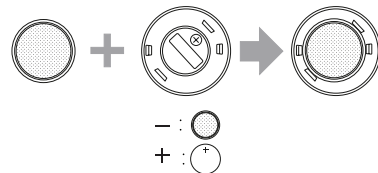

3. Put the battery cover on the remote control and turn it clockwise to close.

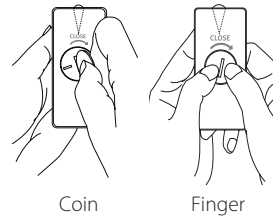

Coin

Finger

Caution

If you have long nails, do not open the battery cover by using your finger. Or else, your nail would be broken.

Front Panel

1

Getting Started

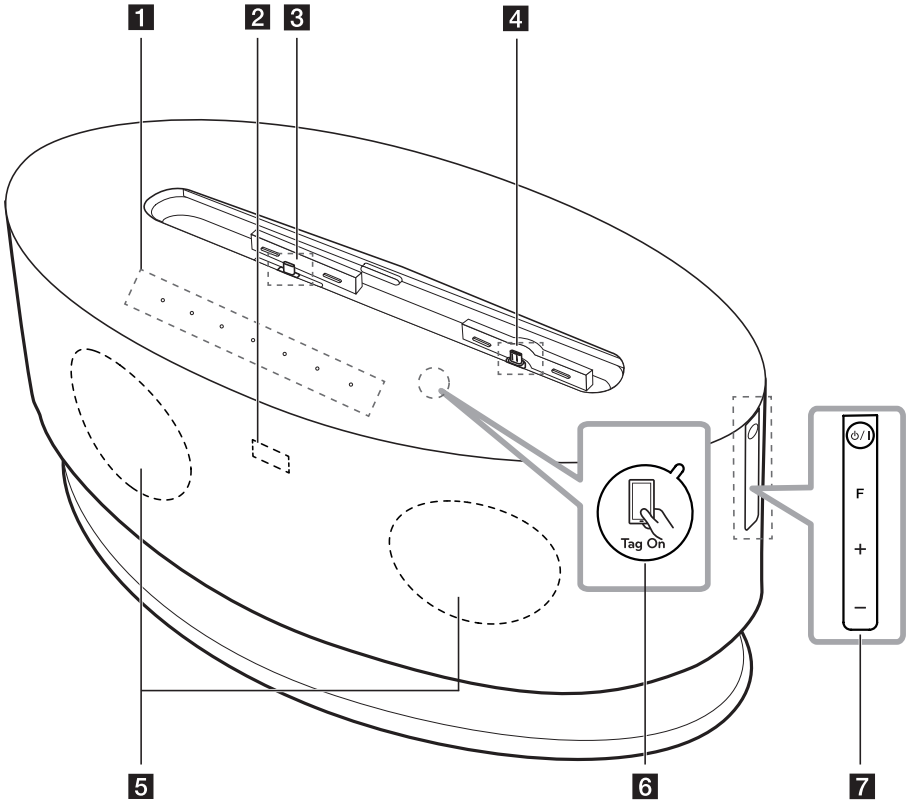

! Note

How to open the dock station

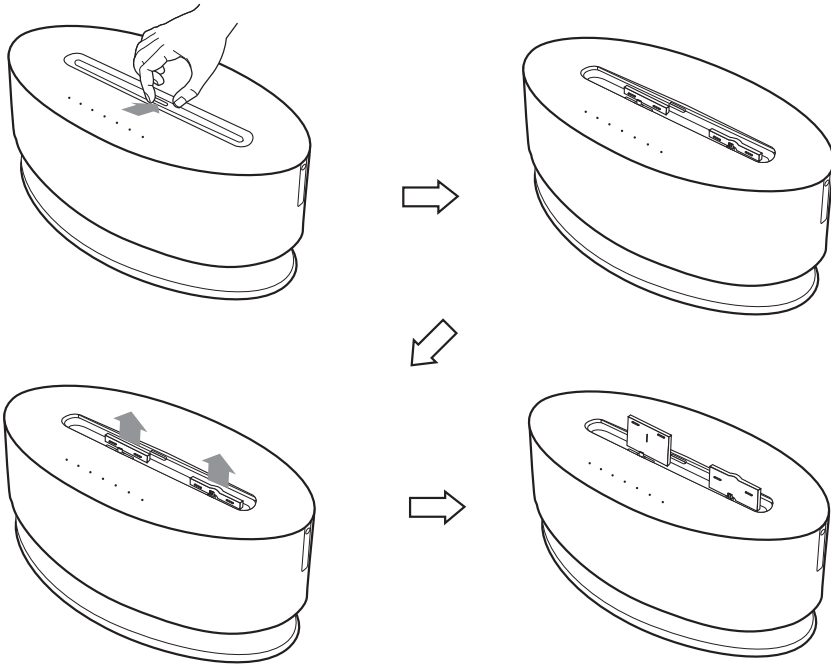

- 1** Display window
Displays each of functions.
- 2** Remote sensor
- 3** iPod/iPhone/iPad Dock (Lightning Connector)
Connects your iPod/iPhone/iPad.
- 4** Android device Dock (Micro USB)
Connects your Android device.
- 5** Speaker
- 6** Tag on
LG Tag On allows you to install and open "LG Bluetooth Remote" app to NFC-enabled phone.
- 7** / : Switches the unit ON or OFF.
F : Selects the function and input source.
(LG Sound Sync function is only selected by using the **SOUND SYNC** button on the rear of the unit.)
+/- (Volume) : Adjusts speaker volume.

! Caution

Precautions in using the touch buttons

- Use the touch buttons with clean and dry hands.
- In a humid environment, wipe out any moisture on the touch buttons before using.
- Do not press the touch buttons hard to make it work.
- If you apply too much strength, it can damage the sensor of the touch buttons.
- Touch the button that you want to work in order to operate the function correctly.
- Be careful not to have any conductive material such as metallic object on the touch buttons. It can cause malfunctions.

Back Panel

1

Getting Started

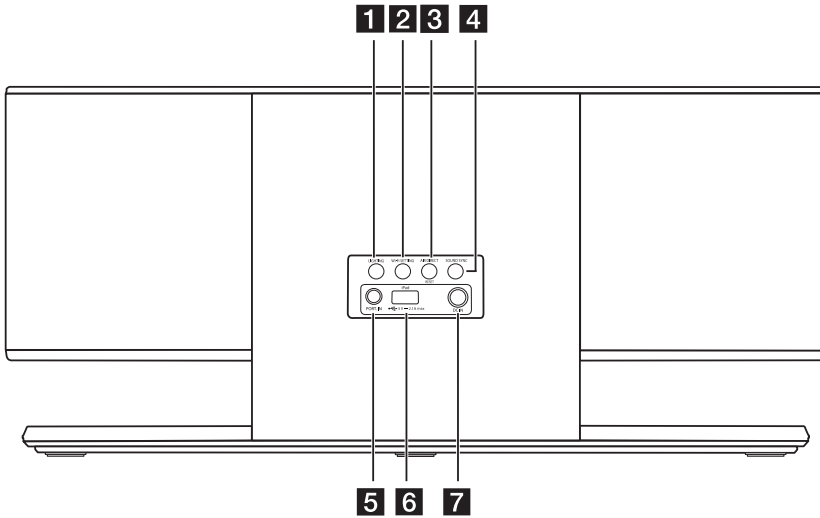

1 LIGHTING

Adjusts the brightness of lighting.

2 Wi-Fi SETTING

Connects your unit to the existing Wi-Fi network.

3 AIR DIRECT/RESET

- Creates new Wi-Fi network with your unit.
- Initializes Wi-Fi network's configuration.

4 SOUND SYNC

Synchronizes this unit and your LG TV.

5 PORT.IN (3.5 mm)

Listens to music from your portable device.

6 USB Port

- Plays music file by using your USB cable for iPod/iPhone/iPad.
- Charges your portable device.

7 DC IN (AC adapter input)

Connects the supplied AC adapter.

! Note

Wi-Fi SETTING and **AIR DIRECT/RESET** buttons are only available in "AirPlay" function.

Connecting the AC Adapter

1. Connect the supplied AC power cord to the AC adapter.
2. Connect the AC adapter cable to DC IN adapter input.
3. Plug the AC power cord into an AC outlet. Then the unit goes into standby mode.

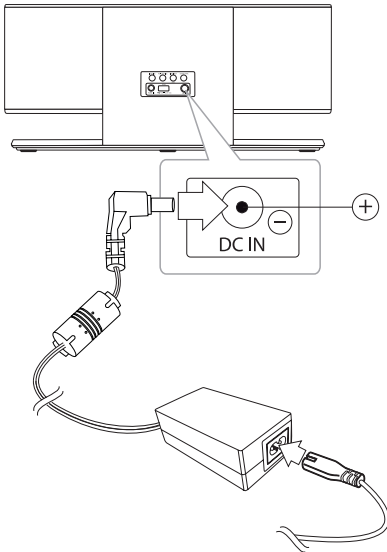

Caution

Only use the AC adapter supplied with this device. Do not use a power supply from another device or manufacturer. Using any other power cable or power supply may cause damage to the device and void your warranty.

About Ferrite Core (Optional)

This ferrite core can reduce noises.

How to attach the ferrite core

1. Pull the stopper [a] of the ferrite core to open.
2. Wind the portable cable and USB cable on the ferrite core.
3. Close the ferrite core until it clicks.

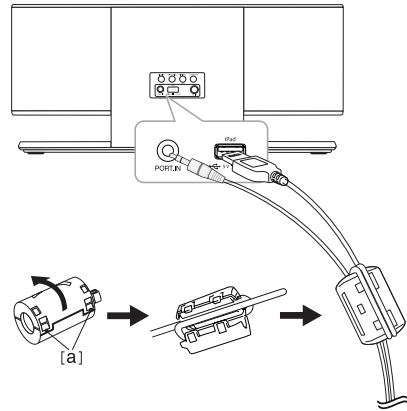

Basic Operations

iPod/iPhone/iPad Operation

You can enjoy the sound from your iPod/iPhone/iPad through this unit. For details about iPod/iPhone/iPad, refer to the iPod/iPhone/iPad User Guide.

! Note

- You are recommended to remove the case for your iPod/iPhone/iPad before you place your iPod/iPhone/iPad into the dock.
- Before connecting, please check the position to connect. Refer to the page 8-9.

Connecting an iPod/iPhone/iPad (Lightning connector) to Dock

1. Connect your iPod/iPhone/iPad (Lightning connector) to Dock firmly.

When this unit is connected to power, your iPod/iPhone/iPad is automatically turned on and starts recharging even in standby mode.

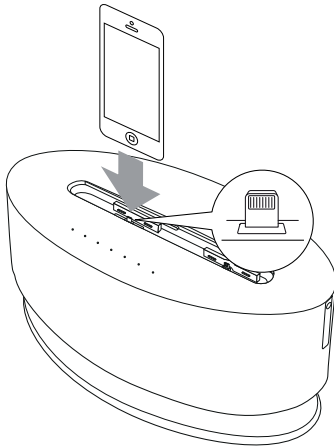

2. Press **FUNCTION** or **F** to select **iPod** function.

Connecting an iPod/iPhone/iPad (30-Pin/Lightning connector) to USB port

1. Connect your iPod/iPhone/iPad (30-pin/Lightning connector) to USB port using the appropriate cable.

When this unit is connected to power, your iPod/iPhone/iPad is automatically turned on and starts recharging even in standby mode.

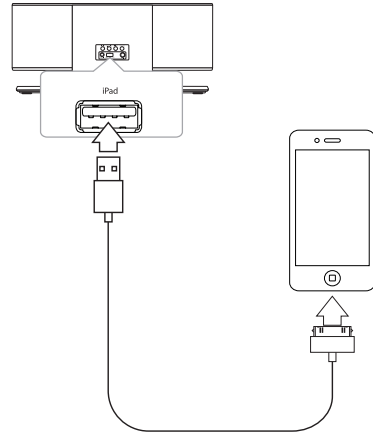

2. Press **FUNCTION** or **F** to select **(USB)** function.

To	Do this
Play	Press >/II .
Pause	During playback, Press >/II .
Skip	During playback, press I<</>>I to go to the next file or to return to the beginning of the current file. Playing less than 2 seconds, press I<< to go to the previous file. Playing after 3 seconds, press I<< to go to the beginning of the file.
Search	Press and hold I<</>>I during playback and release it at the point you want to listen to.

Compatible iPod/iPhone/iPad

The unit supports the models as follows ;

- iPod touch 3G, 4G, 5G
- iPod nano 4G, 5G, 6G, 7G
- iPhone 5
- iPhone 4S
- iPhone 4
- iPhone 3GS
- iPad mini
- iPad 2G, 3G, 4G
- iPad

! Note

- When you disconnect your iPod/iPhone/iPad during playback, the playback pauses.
- When your iPod/iPhone/iPad is docked, you cannot control the volume button of your iPod/iPhone/iPad.
- If the connection has an error, check these problems as follows;
 - Your iPod/iPhone/iPad is not connected firmly.
 - This unit recognizes your iPod/iPhone/iPad as an unknown device.
 - Your iPod/iPhone/iPad is exceptionally low in power.
 - ➔ The battery needs to be charged.
 - ➔ If you charge the battery while iPod/iPhone/iPad is extremely low in power, it may take longer to be charged.
- You may not control your iPod/iPhone/iPad from this unit due to malfunction of iPod/iPhone/iPad.
- Depending on your iPod/iPhone/iPad's software version, it may not be possible to control your iPod/iPhone/iPad from this unit. We recommend installing the latest software version.
- If you use an application, make a call, or send and receive SMS text message, etc. on iPod touch/iPhone/iPad, disconnect it from iPod/iPhone/iPad dock of this unit and then use it.
- If you have a problem with your iPod/iPhone/iPad, please visit www.apple.com/support.
- iPod touch, iPhone and iPad have any difference in operation other than iPod. You may need any additional control to use them with this unit. (e.g. "slide to unlock")
- Do not connect two iPad for charge at the same time.

Android device Operation

You can enjoy the sound from your LG Android device through the dock for Android device of this unit. For details about Android device, refer to the Android device User Guide.

To stream audio from your Android device through this unit, you need :

- With Android operation system : Ver 4.1(or later)
- With a micro USB connector

With Android operation system (Version 4.0 or below), this unit can only charge it and you can enjoy audio through Bluetooth.

! Note

- This unit may not compatible with the device that does not support the *AOA (Android Open Accessory) 2.0 version. It is possible that certain devices may not support or be compliant with the AOA2.0 USB audio standard, resulting in the device freezing or rebooting after being connected and detached from the speaker system. If you experience this problem, please contact your device manufacturer. Your device may need to be updated with the latest Jellybean software and or the correct AOA2.0 USB audio standard.

*About AOA (Android Open Accessory) 2.0 version ;

Audio output from Android device to the Accessory and HID (Human Interface Device)

- You are recommended to remove the case for your Android device before you connect your Android device into the dock.
- Before connecting, please check the position to connect. Refer to the page 8-9.
- Depending on the size of your Android device, some devices may not be docked. In this case, you can enjoy audio through Bluetooth.

1. Check the orientation of the micro USB connector on your Android phone.

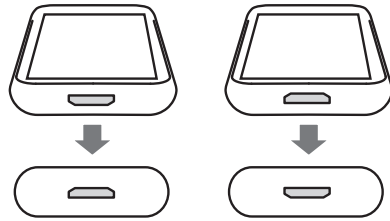

2. Connect your Android device firmly.

! Note

You can rotate Android device Dock. If you want to rotate the dock, pull the dock upwards and then rotate it to the right or left. Please use the supplied tweezers.

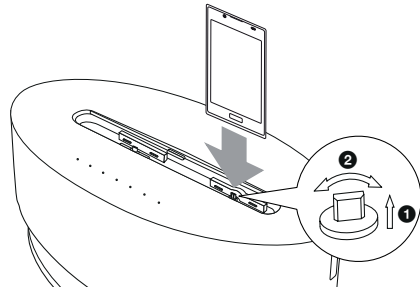

3. Press **FUNCTION** or **F** to select **(ANDROID)** function.

To	Do this
Play	Press >/ .
Pause	During playback, Press >/ .
Skip	During playback, press <</>> to go to the next file or to return to the beginning of the current file. Playing less than 2 seconds, press << to go to the previous file. Playing after 3 seconds, press << to go to the beginning of the file.

! Note

- If the connection has an error, check these problems as follows;
 - Your Android device is not connected firmly.
 - This unit recognizes your Android device as an unknown device.
 - Your Android device is not booted.
 - Check the setting of USB connection type on your Android device.
- When you disconnect your Android device from the dock during playback, the playback may continue.
- In case of no sound from this unit, adjust the volume of your Android device.
- The charging time may vary depending on your Android device.
- Some Android devices may not be charged.
- Depending on the position and orientation of the micro USB connector on your Android device, connect it in portrait or landscape position.
- You may not control your Android device from this unit due to malfunction of Android device.
- Depending on your Android device's software version, it may not be possible to control your Android device from this unit. We recommend installing the latest software version.
- If you use an application, make a call, or send and receive SMS text message, etc. on Android device, disconnect it from Android device dock of this unit and then use it.
- If your Android device does not support AOA (Android Open Accessory) 2.0 version, this unit can only charge your Android device even though Android device has OS 4.1 (or later).

Listening to Music from Your External Device

The unit can be used to play the music from many types of external device. (Portable cable is not supplied as an accessory with this unit.)

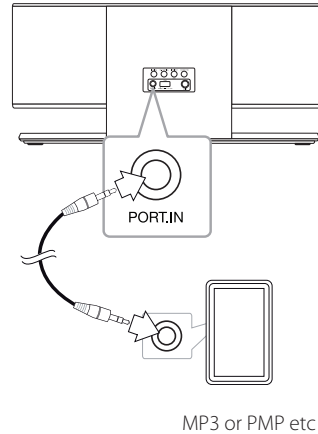

1. Connect the external device to the **PORT.IN** connector of the unit.
2. Turn the power on by pressing or .
3. Select the (PORTABLE) function by pressing **FUNCTION** or **F**.
4. Turn the external device on and start playing it.

Using a Bluetooth Wireless Technology

About Bluetooth

Bluetooth® is wireless communication technology for short range connection.

The available range is within 10 meters.

(The sound may be interrupted when the connection interfered by the other electronic wave or you connect the bluetooth in the other rooms.)

Connecting individual devices under **Bluetooth®** wireless technology does not incur any charges. A mobile phone with **Bluetooth®** wireless technology can be operated via the Cascade if the connection was made via **Bluetooth®** wireless technology.

Available Devices : Mobile phone, MP3, Laptop, PDA.

Bluetooth Profiles

In order to use **Bluetooth®** wireless technology, devices must be able to interpret certain profiles. This unit is compatible with following profile.

A2DP (Advanced Audio Distribution Profile)

Listening to Music of a Bluetooth Device

Before you start the pairing procedure, make sure the Bluetooth feature is turned on in to your Bluetooth device. Refer to your Bluetooth device's user guide. Once a pairing operation is performed, it does not need to be performed again.

1. Select the Bluetooth function by using the **FUNCTION** or **F**.
Bluetooth LED (⌘) blinks.
2. Operate the Bluetooth device and perform the pairing operation. When searching for this unit with the Bluetooth device, a list of the devices found may appear in the Bluetooth device display depending on the type of Bluetooth device. Your unit appears as "LG Docking (XX:XX)".

! Note

XX:XX means the last four digits of BT address. For example, if your unit has a BT address such as 9C:02:98:4A:F7:08, you will see "LG Docking (F7:08)" on your Bluetooth device.

3. Enter the PIN code.
PIN code : 0000

! Note

Depending on the Bluetooth device type, some devices do not require a PIN code.

4. When this unit successfully is connected with your Bluetooth device, Bluetooth LED (⌘) stop blinking.

! Note

- Depending on the Bluetooth device type, some devices have a different pairing way.
- Try pairing procedure if your device name is not in the device list.

5. Listen to music.

To play a music stored on your Bluetooth device, refer to your Bluetooth device's user guide. According to your Bluetooth device's volume level, the volume level of Bluetooth will be adjusted.

! Note

- Sound from the main set can be distorted if you raise the volume of Bluetooth device up to two-thirds or more.
- When you use the Bluetooth function, adjust the volume of a Bluetooth device to a proper level to listen to.
- After your device is connected to the unit via Bluetooth, the function switches to BT automatically. (Except for AirPlay and LG Sound Sync function)
- In LG Sound Sync function, Bluetooth is not connected from your device.
- After searching for this unit on your Bluetooth device, connect the Bluetooth device to this unit. Then play music you want.
- The sound may be interrupted when the connection interfered by the other electronic wave.
- You cannot control the Bluetooth device with this unit.
- Pairing is limited one Bluetooth device per one unit and multi-pairing is not supported.
- Although the distance between your Bluetooth and the set is less than 10 m, there are obstacles between both, your Bluetooth device cannot be connected.
- Depending on the type of the device, you may not be able to use the Bluetooth function.
- You can enjoy wireless system using phone, MP3, Notebook, etc.
- When not connected the Bluetooth, Bluetooth LED (✖) blinks.
- The electrical malfunction due to devices using same frequency such as Medical equipment, Microwaves or wireless LAN devices, the connection will be disconnected.
- When someone stands and interrupts communication between Bluetooth device and the player, the connection will be disconnected.

! Note

- If the gotten away of the distance between Bluetooth and the unit, the sound quality is lower and lower. The connection will disconnect when the space between the Bluetooth and the unit gets out of the operating range of Bluetooth.
- The device with **Bluetooth®** wireless technology is disconnected, if you turn off the main unit or put the device away from the main unit more than 10 m.
- If the Bluetooth device is disconnected, you should connect the Bluetooth device to your unit.

Using Bluetooth App

About "LG Bluetooth Remote" App

"LG Bluetooth Remote" app brings a suite of new features to this unit.

To enjoy more features, you are recommended to download and install free "LG Bluetooth Remote" app.

Install "LG Bluetooth Remote" App through "Apple App Store" or "Google Android Market (Google Play Store)"

1. Tap the "Apple App Store" icon or "Google Android Market (Google Play Store)" icon.
2. In the search bar, type in the "LG Bluetooth Remote" and search it.
3. In the search result list, find and tap "LG Bluetooth Remote" to start downloading Bluetooth app.
4. Tap an icon for installation.
5. Tap an icon for downloading.

! Note

- Make sure that your Bluetooth device is connected to the Internet.
- Make sure that your Bluetooth device is equipped with "Apple App Store" or "Google Android Market (Google Play Store)".
- If you want to get more information, refer to explanation of BT app in "Apple App Store" or "Google Android Market (Google Play Store)".

Install "LG Bluetooth Remote App" by using QR code

1. Install "LG Bluetooth Remote" app through QR code. Use the scanning software to scan the QR code.



(Apple iOS)



(Android OS)

2. Tap an icon for installation.
3. Tap an icon for downloading.

! Note

- Make sure that your Bluetooth device is connected to the Internet.
- Make sure that your Bluetooth device has a scanning software application. If you don't have one, download one from "Apple App Store" or "Google Android Market (Google Play Store)".

Activate Bluetooth with “LG Bluetooth Remote” App

“LG Bluetooth Remote” app helps to connect your bluetooth device to this unit.

! Note

In case of iOS device ;

After performing the pairing operation, activate Bluetooth with LG Bluetooth Remote App.

1. Tap “LG Bluetooth Remote” app icon on the home screen to open “LG Bluetooth Remote” app, and go to the main menu.
2. Tap [Setting] and select the unit you want.
3. If you want to get more information to operate, tap [Setting] and [Help].

! Note

- BT app will be available in the software version as follow;
 - iOS O/S : Ver 4.3 (or later)
 - Android O/S : Ver 2.3.3 (or later)
- If you place your iPod touch/iPhone/iPad into the dock of this unit while your iPod touch/iPhone/iPad is connected to this unit by Bluetooth connection, and you switch this unit to iPod mode, the Bluetooth connection is deactivated.
- If you place your Android device into the dock of this unit while your Android device is connected to this unit by Bluetooth connection, and you switch this unit to ANDROID mode, the Bluetooth connection is deactivated.
- This unit does not support the multi-pairing. If this unit is already connected with other Bluetooth device, disconnect that device and then try again.
- If you use “LG Bluetooth Remote” app for operation, there would be some differences between “LG Bluetooth Remote” app and the supplied remote control. Use the supplied remote control as necessary.
- Depending on the Bluetooth device, “LG Bluetooth Remote” app may not work.
- “LG Bluetooth Remote” app for Apple iOS is slightly different from that of Android OS.
- The connection you’ve made may be disconnected if you select other application or change the setting of the connected device via “LG Bluetooth Remote” app. In such a case, please check the connection status.
- To prevent a malfunction, you are recommended to connect only one device to this unit.
- Don’t connect your smart device by using a cable to USB port. Or else the Bluetooth connection will be disconnected.
- After connection of BT app, music may be output from your device. In this case, try connecting procedure again.

Using AirPlay

Apple AirPlay technology enables you to play your iTunes music library, hosted on a Mac, PC, iPhone, iPod touch, or iPad on any AirPlay-enabled device connected to the Wi-Fi network.

To stream audio wirelessly by AirPlay, you need :

	Wi-Fi Sharing	Air Direct	Webpage
Compatible Apple Device	iPad mini, iPad4, iPad3, iPad2, iPad, iPhone5, iPhone 4S, iPhone 4, iPhone 3GS, iPod touch 5G, iPod touch 4G, iPod touch 3G		
iOS Version	Ver.5.0 (or later)	Ver.4.3.3 (or later)	
iTune Version	Ver.10.2.2 (or later)		
Wireless LAN (internal antenna)	802.11 b/g		
Security Mode	WPA(TKIP/AES) WPA2(TKIP/AES) WEP with Open mode	WEP with Open / Shared mode	WPA(TKIP/AES) WPA2(TKIP/AES) WEP with Open mode
Webpage address	-	192.168.1.1 (Optional for security)	192.168.1.111

- This unit should be connected to the same local network as your iTunes host device through the Wi-Fi router.
- Depending on the kind and operating system or the application's version and the setting status of AirPlay-enabled device connected to this unit, AirPlay may not be operated normally.
- Depending on the Network environment and your device state, It may take long time to connect the unit.
- WPA supports TKIP and WPA2 supports AES first.
- To prevent a malfunction, you are recommended to connect only one device to this unit.

Connecting your Wi-Fi device to Wi-Fi network

Option 1 : Using Wi-Fi Sharing

! Note

Make sure that you set security mode to WPA-TKIP or WPA2-AES in Wi-Fi network router to connect the network more quickly.

1. Connect your iPod touch/iPhone/iPad to the network first, then connect it to the iPod/iPhone/iPad Dock. Please touch your iPod touch/iPhone/iPad before you use.

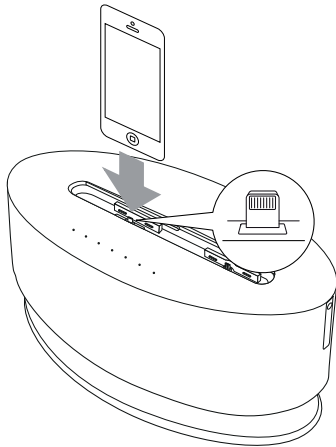

2. Press **FUNCTION** on the remote control or **F** on the unit to select **AirPlay** function.
3. Press **Wi-Fi SETTING** on the unit. "AirPlay" icon will blink with white and amber color alternately.
4. Tap "Allow" from popup window on your iPod touch/iPhone/iPad. Then network information will be shared to the unit.
5. When the unit is connected to the network, "AirPlay" icon will stop blinking and stay in amber color.

Option 2 : Using Air Direct without security

1. Press **FUNCTION** on the remote control or **F** on the unit to select **AirPlay** function.
2. Press **AIR DIRECT/RESET** on the unit. Then "AirPlay" icon blinks with white and amber color alternately. When the unit is changed to Air Direct Mode, "AirPlay" icon stops blinking and stays in white color.
3. In the network list, find and select "LG AIR DIRECT XXXXXX".



4. Use AirPlay after your iPod touch/iPhone/iPad or PC/MAC is connected.

! Note

- If "LG AIR DIRECT XXXXXX" is not in the list, try to scan the available Wi-Fi networks again.
- When your iPod touch/iPhone/iPad or PC/MAC is connected to "LG AIR DIRECT XXXXXX", you can't use internet.
- When you disconnect Air Direct, this unit will automatically attempt to reconnect Wi-Fi sharing or Webpage it has last accessed.

Using Air Direct with Security mode

5. Launch Apple Safari browser or Microsoft Internet Explorer browser on your iPod touch/iPhone/iPad or PC/MAC.
6. Type in "192.168.1.1" at the browser address bar and confirm.
7. Set security mode and insert password.
 - hexadecimal (0-9, A-F) 10 or 26 digits.
 - 5 or 13 ASCII characters.
8. Tap or click "OK"

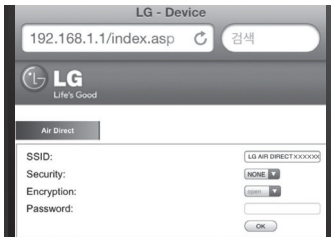

9. In the network list, find and select "LG AIR DIRECT XXXXXX" again.



10. If you want to get back to non-security mode, select security type as None.

! Note

- If you want to deactivate Air Direct function, press **AIR DIRECT/RESET**.
- If you want to initialize Wi-Fi network's Security Mode, press and hold **AIR DIRECT/RESET**.
- When you change the security mode, please disconnect the existing connection and then reconnect unit to AirPlay-enabled device.
- If connection setup fails to complete, press and hold **AIR DIRECT/RESET**.

Option 3 : Using Webpage

The new Wi-Fi network created by this unit only allows access of one Wi-Fi enabled device. To avoid interference from any other Wi-Fi devices, you are recommended to temporarily disable the Wi-Fi function on your other Wi-Fi devices.

! Note

- "LG AUDIO Setup XXXXXX" is the temporary and assistant Wi-Fi network for connection of this unit to your home Wi-Fi router.
- While your iPod touch/iPhone/iPad or your Wi-Fi enabled PC/Mac is connecting to "LG AUDIO Setup XXXXXX" network, you can not use Internet.

1. Press **FUNCTION** on the remote control or **F** on the unit to select **AirPlay** function.
2. Press and hold **Wi-Fi SETTING**. "AirPlay" icon will blink with white and amber color alternately.
3. After 20 seconds, select "LG AUDIO Setup XXXXXX" in the network list on your iPod/iPhone/iPad or PC/MAC. "AirPlay" icon will blink quickly.

! Note

- If "LG AUDIO Setup XXXXXX" is not in the list, try to scan the available Wi-Fi networks again.
- If you want to deactivate Webpage function, press and hold **Wi-Fi SETTING**.

4. Launch Apple Safari browser or Microsoft Internet Explorer browser on your iPod touch/ iPhone/iPad or PC/MAC.
5. Type in "192.168.1.111" at the browser address bar and confirm.
6. Select your network name (SSID) from "Wireless Network".
7. Enter the network key if required.
8. Tap or click "OK" to proceed with network settings change.
 - Follow the on-screen instructions to change and confirm the internal Wi-Fi settings of this unit.
 - Please wait about 30 seconds and more.

Note

- If you use other characters than the English alphabet or digits for the SSID name of your access point or wireless router, it may be displayed differently.
- WEP security mode generally have 4 keys available on an access point setting. If your access point or wireless router use WEP security, enter the security code of the key "No.1" to connect on your home network.
- An Access Point is a device that allows you to connect to your home network wirelessly.

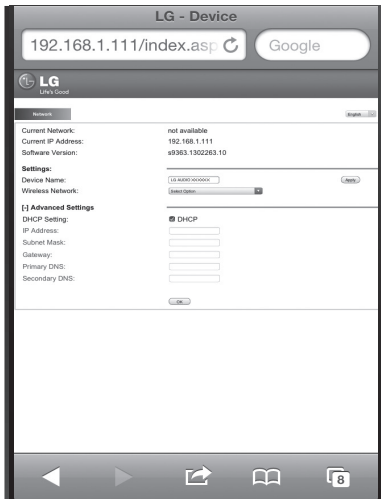

9. If this unit is connected to your selected home Wi-Fi network successfully, "AirPlay" icon stops blinking and stays in amber color.
10. If you have security on your access point, you need to input the security code as necessary.

Streaming audio from your iTunes music library to this unit

Note

Make sure that your iTunes host device is connected to the same Wi-Fi network as this unit. Your iTunes device can be an iPod touch/ iPhone/iPad installed with iOS 4.3.3 (or later) or a Wi-Fi enabled PC/Mac installed with iTunes 10.2.2 (or later).

Stream from your iPod touch/ iPhone/iPad

1. Launch the "Music" application on your iPod touch/iPhone/iPad.



2. Tap on the AirPlay icon.

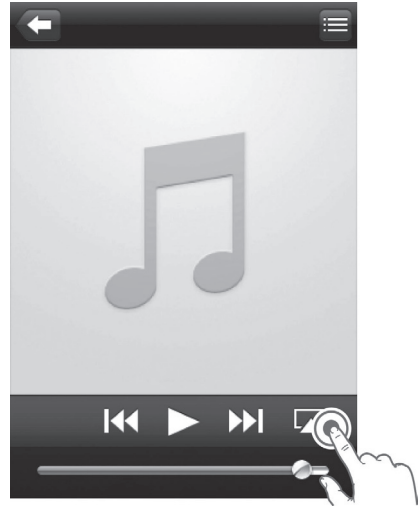

3. Select "LG AUDIO XXXXXX" (or user customized name) from the AirPlay list.

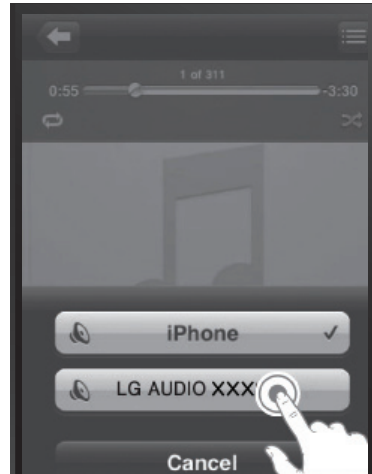

4. Select a media file and start play.
 - After a while, you will hear music from this unit.
 - Depending on your connection environment and network condition, audio output may not be normal.

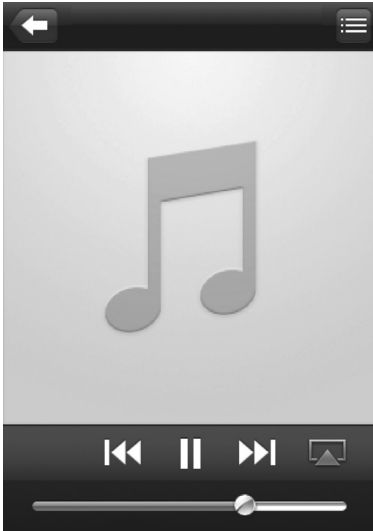
**Note**

If you fail to hear music after successful setup, do one of the following on your iPod touch/iPhone/iPad:

- Disconnect and then re-connect to the same Wi-Fi router again.
- Close all applications running at the background.
- Power off and then power on your iPod touch/iPhone/iPad again.

Other Operations

LG Tag On

LG Tag On allows you to install and open “LG Bluetooth Remote” app to NFC-enabled phone.

1. Activates the NFC feature of your NFC-enabled phone.
2. Turn on the unit.
3. Tag the back of your NFC-enabled phone over the unit.

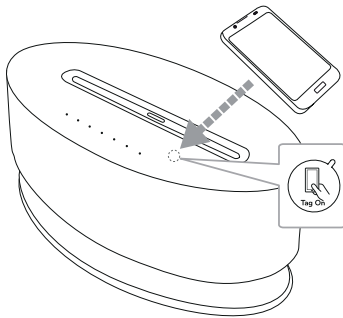

- If “LG Bluetooth Remote” app is not installed on your NFC-enabled phone, the linked screen with “LG Bluetooth Remote” app is displayed.
- If “LG Bluetooth Remote” app is installed on your NFC-enabled phone, “LG Bluetooth Remote” app is activated.

! Note

- You must activate the NFC feature of your NFC-enabled phone.
- If your NFC-enabled phone's screen is locked, it will not read the NFC.
- If your smart phone case is plated with chrome, NFC is unavailable. Depending on your case's material or thickness, NFC may not be read well.

LG Sound Sync



You can control some functions of this unit by your TV's remote control with LG Sound Sync. It is compatible with the LG TV that is supported LG Sound Sync. Make sure of the LG Sound Sync logo on your TV.

Controllable function by LG TV's remote control :
Volume up/down, mute

Refer to the TV's instruction manual for the details of LG Sound Sync.

! Note

- You can also use the remote control of this unit while using LG Sound Sync. If you use TV's remote control again, the unit synchronizes with the TV.
- When the connections failed, make sure of the condition of the TV and power of it.
- Make sure of the condition of this unit and the connection in the cases below when using LG Sound Sync.
 - Turned off the unit.
 - Changing the function to the others.
 - Disconnecting the wireless connection caused by interference or a distance.

With wireless connection

1. Turn on the unit.
2. Press **SOUND SYNC** on the rear of the unit to select the  (LG Sound Sync) function.
3. Set up LG Sound Sync (Wireless) on the TV. Refer to the TV's instruction manual.

If your unit and LG TV are connected normally,  icon will stop blinking and stay in amber color.

! Note



- The device with *Bluetooth*® wireless technology will be disconnected, if LG Sound Sync function is selected. Bluetooth remote app you've already connected is disconnected either.
- In LG Sound Sync function, you can search and connect this unit through LG TV only.
- In LG Sound Sync function, the volume step of this unit will be changed to the volume step of LG TV.

Setting BASS (BASS BLAST) sound effect

You can listen to music by setting BASS (BASS BLAST) sound effect. Press **BASS EQ** repeatedly. Then you can reinforce BASS (BASS BLAST) sound effect.

BASS (BASS BLAST) <-> BYPASS

Turning Off the Sound Temporarily

Press  to mute the sound. You can mute the sound in order, for example, to answer the telephone. To cancel mute function, press  again or adjust volume level by pressing +/- (Volume).

Adjusting the brightness of the lighting

You can adjust the brightness of the lighting.

Press **LIGHTING** repeatedly. Then the brightness of the lighting will be changed.

MAX -> MIDDLE -> OFF -> MAX -> ...

Auto Power Down









This unit will power itself down to save electronic consumption in case main unit is not connected to external device and is not used for 25 minutes.

Also this unit will power down if no input is connected using the analogue input after six hours.

Troubleshooting

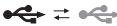
Problem	Cause & Correction
No Power.	<ul style="list-style-type: none"> • Plug in the power cord. • Check the condition by operating other electronic devices.
No sound.	<ul style="list-style-type: none"> • Press  FUNCTION or F and check the selected function. • Adjust the volume of your portable device. • Check that the sound of the unit is muted.
iPod/iPhone/iPad does not work.	<ul style="list-style-type: none"> • Connect iPod/iPhone/iPad to the unit correctly.
Audio is not output from your docked Android device.	<ul style="list-style-type: none"> • Make sure that you are using Android system of version 4.1 or later. • Connect Android device to the unit correctly.
The remote control does not work properly.	<ul style="list-style-type: none"> • The remote control is not pointed at the remote sensor of the unit. • The remote control is too far from the unit. • There is an obstacle in the path of the remote control and the unit. • The battery in the remote control is exhausted.
Bluetooth pairing does not work well.	<ul style="list-style-type: none"> • Switch Bluetooth off and on again on your Bluetooth device, then try pairing again. • Be sure your Bluetooth device is on. • Remove the obstacle in the path of the Bluetooth device and the unit. • Depending on the type of the Bluetooth device or surrounding environment, your device may not be paired with the unit. • When your Bluetooth device have been already connected with other unit, disconnect the Bluetooth connection first. Then you can control your unit through BT app. • Depending on the Bluetooth device, BT app may work restrictively not work. • The connection you've made may be disconnected if you select other application or change the setting of the connected device via BT app. In such case, please check the connection status.

About LED condition

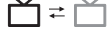
Function	Condition	LED	Description
iPod	iPod Connected	iPod	
	No iPod	iPod ⇄ iPod	Blinks Slowly
Android	Android Connected		
	Android Loading		Blinks Quickly
	No Android		Blinks Slowly
USB	USB		
	No USB		Blinks Slowly
Bluetooth	Bluetooth Paired		
	Bluetooth Ready		Blinks Slowly
Portable	Portable In		
LG Sound Sync	LG Sound Sync Connected		
	LG Sound Sync Ready		Blinks Slowly
AirPlay	AirPlay Disconnected	AirPlay ⇄ AirPlay (Amber)	Blinks Slowly
	Using Wi-Fi Sharing Connecting	AirPlay ⇄ AirPlay (Amber) (White)	Blinks Quickly
	Using Wi-Fi Sharing Connected	AirPlay (Amber)	
	Using Air Direct Preparing	AirPlay ⇄ AirPlay (Amber) (White)	Blinks Quickly
	Using Air Direct Connected	AirPlay (White)	
	Using Webpage Searching AirPlay enabled device	AirPlay ⇄ AirPlay (Amber) (White)	Blinks Slowly
	Using Webpage Searched AirPlay-enabled device	AirPlay ⇄ AirPlay (Amber) (White)	Blinks Quickly
	Using Webpage Connected	AirPlay (Amber)	

Trademarks and Licenses



"Made for iPod," "Made for iPhone," and "Made for iPad" mean that an electronic accessory has been designed to connect specifically to iPod, iPhone, or iPad, respectively, and has been certified by the developer to meet Apple performance standards. Apple is not responsible for the operation of this device or its compliance with safety and regulatory standards. Please note that the use of this accessory with iPod, iPhone, or iPad may affect wireless performance.



Bluetooth® wireless technology is a system which allows radio contact between electronic devices within a max. range of 10 meters.

Connecting individual devices under **Bluetooth**® wireless technology does not incur any charges. A mobile phone with **Bluetooth**® wireless technology can be operated via the Cascade if the connection was made via **Bluetooth**® wireless technology.

The **Bluetooth**® word mark and logos are owned by the **Bluetooth**® SIG, Inc. and any use of such marks by LG Electronics is under license.

Other trademarks and trade names are those of their respective owners.



The Wi-Fi CERTIFIED Logo is a certification mark of the Wi-Fi Alliance.

Handling the Unit

When Shipping the Unit

Please save the original shipping carton and packing materials. If you need to ship the unit, for maximum protection, re-pack the unit as it was originally packed at the factory.

Keeping the Exterior Surfaces Clean

Do not use volatile liquids such as insecticide spray near the unit.



Wiping with strong pressure may damage the surface.

Do not leave rubber or plastic products in contact with the unit for a long period of time.

Cleaning the Unit

To clean the player, use a soft, dry cloth. If the surfaces are extremely dirty, use a soft cloth lightly moistened with a mild detergent solution. Do not use strong solvents such as alcohol, benzine, or thinner, as these might damage the surface of the unit.

Specifications

General	
AC adapter requirements	DC 18 V  2.67 A, 100 - 240 V, 50/60 Hz
Power consumption	48 W
Dimensions (W x H x D)	(450 x 200 x 227) mm
Net Weight (Approx.)	5.8 kg
Operating temperature	5 °C to 35 °C (41 °F to 95 °F)
Operating humidity	5 % to 90 %
Bus Power Supply	USB/iPod/iPhone/iPad : 5 V  2.1 A Micro USB : 5 V  1.0 A

Inputs	
PORT. IN	0.5 Vrms (3.5 mm stereo jack)

Amplifier	
Output Power	40 W X 2 ch (4 Ω at 1 kHz)
T.H.D	15 %

Speakers	
Type	built-in
Impedance	4 Ω
Rated Input Power	40 W
Max Input Power	80 W

- Design and specifications are subject to change without notice.

