



ENGLISH

OWNER'S MANUAL

100 W 2.1 ch Built-in Subwoofer Sound Bar

Please read this manual carefully before operating your set and retain it for future reference.

NB2530A



MFL67892865

www.lg.com

Safety Information



CAUTION: TO REDUCE THE RISK OF ELECTRIC SHOCK DO NOT REMOVE COVER (OR BACK) NO USER-SERVICEABLE PARTS INSIDE REFER SERVICING TO QUALIFIED SERVICE PERSONNEL.



This lightning flash with arrowhead symbol within an equilateral triangle is intended to alert the user to the presence of uninsulated dangerous voltage within the product's enclosure that may be of sufficient magnitude to constitute a risk of electric shock to persons.



The exclamation point within an equilateral triangle is intended to alert the user to the presence of important operating and maintenance (servicing) instructions in the literature accompanying the product.

WARNING: This product contains chemicals known to the State of California to cause cancer and birth defects or other reproductive harm. ***Wash hands after handling.***

WARNING: TO PREVENT FIRE OR ELECTRIC SHOCK HAZARD, DO NOT EXPOSE THIS PRODUCT TO RAIN OR MOISTURE.

CAUTION: The apparatus shall not be exposed to water (dripping or splashing) and no objects filled with liquids, such as vases, shall be placed on the apparatus.

WARNING: Do not install this equipment in a confined space such as a book case or similar unit.

CAUTION: Do not block any ventilation openings. Install in accordance with the manufacturer's instructions.

Slots and openings in the cabinet are provided for ventilation and to ensure reliable operation of the product and to protect it from over heating. The openings shall be never be blocked by placing the product on a bed, sofa, rug or other similar surface. This product shall not be placed in a built-in installation such as a bookcase or rack unless proper ventilation is provided or the manufacturer's instruction has been adhered to.

CAUTION concerning the Power Cord

Most appliances recommend they be placed upon a dedicated circuit;

That is, a single outlet circuit which powers only that appliance and has no additional outlets or branch circuits. Check the specification page of this owner's manual to be certain. Do not overload wall outlets. Overloaded wall outlets, loose or damaged wall outlets, extension cords, frayed power cords, or damaged or cracked wire insulation are dangerous. Any of these conditions could result in electric shock or fire. Periodically examine the cord of your appliance, and if its appearance indicates damage or deterioration, unplug it, discontinue use of the appliance, and have the cord replaced with an exact replacement part by an authorized service center. Protect the power cord from physical or mechanical abuse, such as being twisted, kinked, pinched, closed in a door, or walked upon. Pay particular attention to plugs, wall outlets, and the point where the cord exits the appliance. To disconnect power from the mains, pull out the mains cord plug. When installing the product, ensure that the plug is easily accessible.

This device is equipped with a portable battery or accumulator.

Safety way to remove the battery or the battery from the equipment: Remove the old battery or battery pack, follow the steps in reverse order than the assembly. To prevent contamination of the environment and bring on possible threat to human and animal health, the old battery or the battery put it in the appropriate container at designated collection points. Do not dispose of batteries or battery together with other waste. It is recommended that you use local, free reimbursement systems batteries and accumulators. The battery shall not be exposed to excessive heat such as sunshine, fire or the like.

IMPORTANT SAFETY INSTRUCTIONS

1. Read these instructions.
2. Keep these instructions.
3. Heed all warnings.
4. Follow all instructions.
5. Do not use this apparatus near water.
6. Clean only with dry cloth.
7. Do not block any ventilation openings. Install in accordance with the manufacturer's instructions.
8. Do not install near any heat sources such as radiators, heat registers, stoves, or other apparatus (including amplifiers) that produce heat.
9. Do not defeat the safety purpose of the polarized or grounding-type plug. A polarized plug has two blades with one wider than the other. A grounding type plug has two blades and a third grounding prong. The wide blade or the third prong are provided for your safety. If the provided plug does not fit into your outlet, consult an electrician for replacement of the obsolete outlet.
10. Protect the power cord from being walked on or pinched particularly at plugs, convenience receptacles, and the point where they exit from the apparatus.

11. Only use attachments/accessories specified by the manufacturer.
12. Use only with the cart, stand, tripod, bracket, or table specified by the manufacturer, or sold with the apparatus. When a cart is used, use caution when moving the cart/apparatus combination to avoid injury from tip-over.



13. Unplug this apparatus during lightning storms or when unused for long periods of time.
14. Refer all servicing to qualified service personnel. Servicing is required when the apparatus has been damaged in any way, such as power-supply cord or plug is damaged, liquid has been spilled or objects have fallen into the apparatus, the apparatus has been exposed to rain or moisture, does not operate normally, or has been dropped.

FCC Compliance Statement

This device complies with part 15 of the FCC rules. Operation is subject to the following two conditions:

- (1) This device may not cause harmful interference, and
- (2) This device must accept any interference received, including interference that may cause undesired operation.

NOTE: This equipment has been tested and found to comply with the limits for a Class B digital device, pursuant to Part 15 of the FCC Rules. These limits are designed to provide reasonable protection against harmful interference in a residential installation. This equipment generates, uses, and can radiate radio frequency energy and, if not installed and used in accordance with the instructions, may cause harmful interference to radio communications. However, there is no guarantee that interference will not occur in a particular installation. If this equipment does cause harmful interference to radio or television reception, which can be determined by turning the equipment off and on, the user is encouraged to try to correct the interference by one or more of the following measures:

- Reorient or relocate the receiving antenna.
- Increase the separation between the equipment and receiver.
- Connect the equipment into an outlet on a circuit different from that to which the receiver is connected.
- Consult the dealer or an experienced radio/TV technician for help.

CAUTION : Any changes or modifications not expressly approved by the party responsible for compliance could void the user's authority to operate this equipment.

FCC WARNING: This equipment may generate or use radio frequency energy. changes or modifications to this equipment may cause harmful interference unless the modifications are expressly approved in the instruction manual. The user could lose the authority to operate this equipment if an unauthorized change or modification is made.

FCC RF Radiation Exposure Statement : This equipment complies with FCC radiation exposure limits set forth for an uncontrolled environment. This equipment should be installed and operated with minimum distance 20 cm between the radiator and your body. End users must follow the specific operating instructions for satisfying RF exposure compliance. This transmitter must not be co-located or operating in conjunction with any other antenna or transmitter.

FCC Radio Frequency Interference Requirements

This device is restricted to indoor use due to its operation in the 5.15 to 5.25 GHz frequency range. FCC requires this product to be used indoors for the frequency range 5.15 to 5.25 GHz to reduce the potential for harmful interference to co-channel Mobile Satellite systems. High power radars are allocated as primary users of the 5.25 to 5.35 GHz and 5.65 to 5.85 GHz bands. These radar stations can cause interference with and/or damage this device. This device cannot be co-located with any other transmitter.

CAUTION: Regulations of the FCC and FAA prohibit airborne operation of radio-frequency wireless devices because their signals could interfere with critical aircraft instruments.

Responsible Party :

LG Electronics USA, Inc. 1000 Sylvan Avenue
Englewood Cliffs, NJ 07632
TEL. : +1-800-243-0000

Table of Contents

1 Getting Started

- 2 Safety Information
- 6 Unique features
- 6 - Auto power down
- 6 - Portable In
- 6 - Speaker ez (easy) setup
- 6 - LG Sound Sync
- 6 Introduction
- 6 - Symbols used in this manual
- 6 Accessories
- 7 Remote control
- 8 Front panel
- 8 Rear panel
- 9 Mounting the main unit on a wall

2 Connecting

- 11 Optional equipment connection
- 11 - PORT(Portable). IN connection
- 11 - OPTICAL In connection
- 12 - USB connection
- 12 - Playable file
- 12 - Compatible USB devices
- 12 - USB device requirement

3 Operating

- 13 Basic operations
- 13 - USB operation
- 13 Other operations
- 13 - DRC (Dynamic range control)
- 13 - AV Sync
- 13 - Displaying file and input source
- 13 - Turn off the sound temporarily
- 14 - AUTO POWER On/Off
- 14 - Auto power down
- 14 - Sleep timer setting
- 15 - LG Sound Sync
- 16 Using Bluetooth technology
- 17 - Listening to music stored on the Bluetooth devices
- 18 Sound adjustment
- 18 - Setting the surround mode
- 18 - Auto volume On/Off
- 18 - Adjust the woofer level settings
- 19 Controlling a TV with the supplied remote control
- 19 - Setting up the remote to control your TV

4 Troubleshooting

- 20 Troubleshooting

5 Appendix

- 21 Trademarks and licenses
- 21 Maintenance
- 21 - Handling the unit
- 22 Specifications

1

2

3

4

5

Unique features

Auto power down

This unit supports to power off by itself for saving energy consumption.

Portable In

Listen to music from your portable device. (MP3, Notebook, etc)

Speaker ez (easy) setup

Listen to audio from TV, DVD or Digital device with vivid 2.1 or 2.0 ch mode.

LG Sound Sync

Controls volume level of this unit by the remote control of your LG TV that is compatible with LG Sound Sync.

Introduction

Symbols used in this manual

! Note

Indicates special notes and operating features.

! Tip

Indicates tip and hints for making the task easier.

! Caution

Indicates cautions for preventing possible damages from abuse.

Accessories

Please check and identify the supplied accessories.

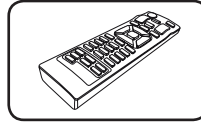

Remote control (1)

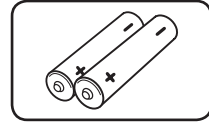

Batteries (2)

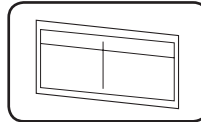

Wall bracket install guide (1)

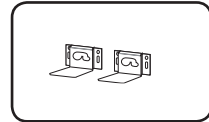

Wall brackets (2)

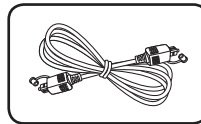

Optical cable (1)

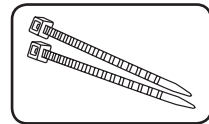

Cable ties for arranging cables (2)

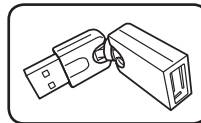

USB gender changer (1)

Remote control

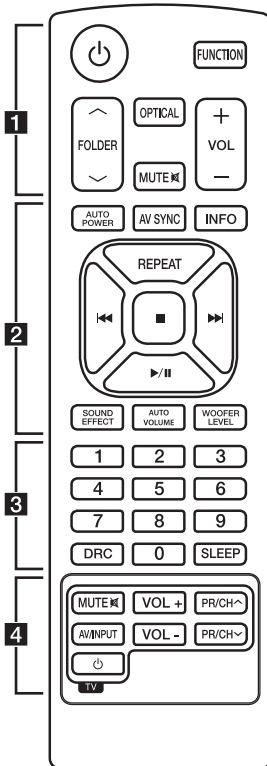

Battery installation

Remove the battery cover on the rear of the Remote Control, and insert two (size AAA) battery with \oplus and \ominus matched correctly.

..... **1**

Power (Power): Switches the unit ON or OFF.

FUNCTION: Changes input sources.

^ / V FOLDER: Searches for a folder of MP3/WMA files. When an USB containing MP3/WMA files in several folders is being played, press **^ / V FOLDER** to select the folder you want to play.

OPTICAL: Changes input source to optical directly.

MUTE \boxtimes : Mutes the sound.

-/+ VOL: Adjusts speaker volume.

..... **2**

AUTO POWER: This function is automatically turned on the unit.

AV SYNC: Synchronizes the audio and video.

INFO: Displays the file or input source information.

REPEAT: Listens to your files repeatedly or randomly.

⏮ / ⏭ (Skip/ Search) :

- Skips Fast backward or Forward.

- Searches for a section within a file.

■: Stops playback.

▶ / ⏸: Starts playback. / Pauses playback.

SOUND EFFECT: Selects a sound effect mode.

AUTO VOLUME: Turns on and off the AUTO VOLUME mode.

WOOFER LEVEL: Sets the sound level of woofer.

..... **3**

0 to 9 numerical buttons: Selects numbered files.

DRC: Sets DRC(Dynamic range control) function.

SLEEP: Sets the system to turn off automatically at a specified time.

..... **4**

TV Control buttons: See page 19.

Front panel

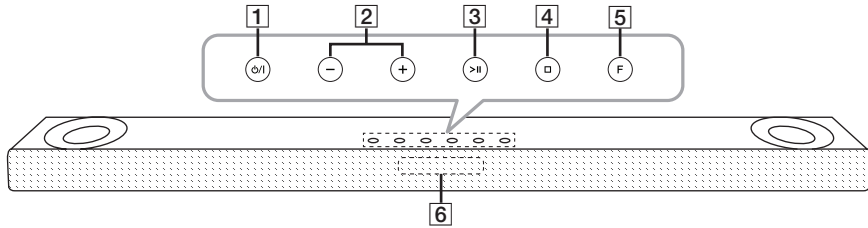

- 1** (Standby/On)
- 2** (Volume)
Adjusts speaker volume.
- 3** (Play / Pause)
- 4** (Stop)
- 5** **F** (Function)
Press it repeatedly to select other function.
- 6** Display window

Caution

Precautions in using the touch buttons

- Use the touch buttons with clean and dry hands.
 - In a humid environment, wipe out any moisture on the touch buttons before using.
- Do not press the touch buttons hard to make it work.
 - If you apply too much strength, it can damage the sensor of the touch buttons.
- Touch the button that you want to work in order to operate the function correctly.
- Be careful not to have any conductive material such as metallic object on the touch buttons. It can cause malfunctions.

Rear panel

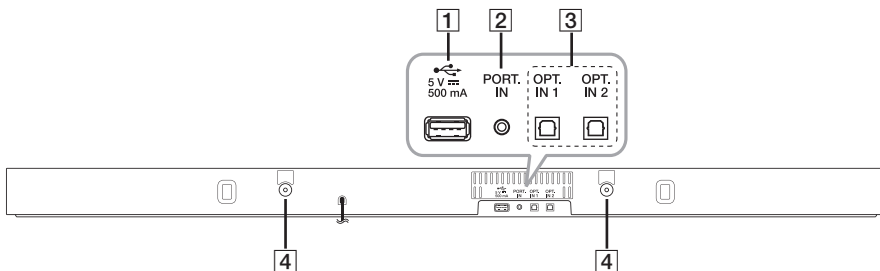

- 1** **5 V** **500 mA** : USB Port
- 2** **PORT.IN** : Portable input
- 3** **OPT. IN 1 / OPT. IN 2** : Optical input
- 4** Shaft for wall mount

Mounting the main unit on a wall

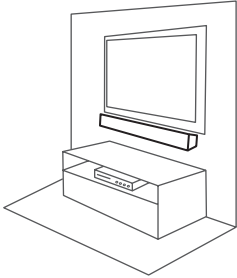

You can mount the main unit on a wall. Prepare screws and brackets.

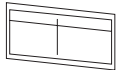
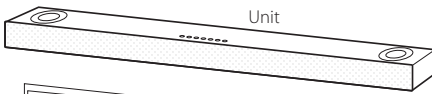

Wall bracket install guide



Wall bracket

! Note

You should connect the supplied USB gender changer in advance of mounting the unit on the wall for using a USB connection.

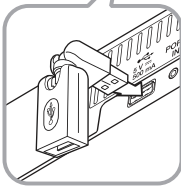
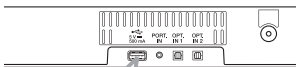

1. Match the TV's BOTTOM EDGE of Wall bracket install guide with the bottom of TV and attach to the position.

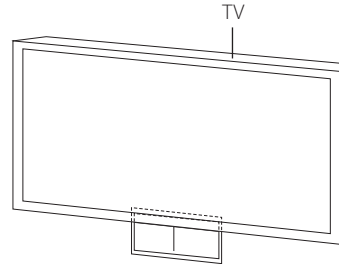

2. When you mount it on a wall (concrete), use the wall plugs (Not supplied). You should drill some holes. A guide sheet (Wall bracket install guide) is supplied to drill. Use the sheet to check the point to drill.

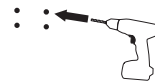
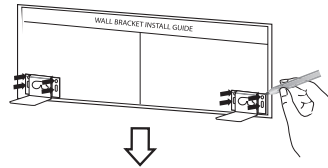

! Note

Screws and Wall Plugs are not supplied for mounting the unit. We recommend the Hilti (HUD-1 6 x 30) for the mounting. Please purchase it.

10 Getting Started

1 Getting Started

3. Remove the Wall bracket install guide.
4. Fix it with screws (not supplied) as shown in the illustration below.

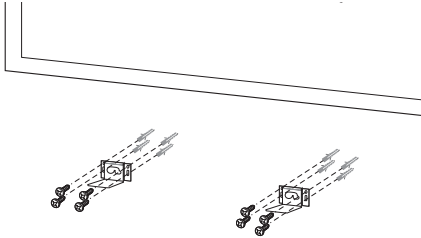

5. Hang the main unit onto the bracket as shown below.

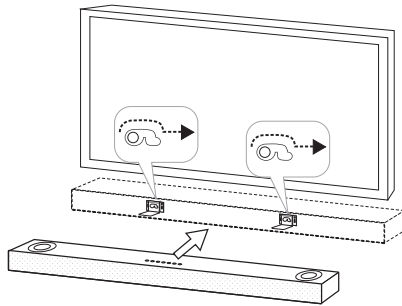

! Caution

- Do not install this unit upside down. It can damage the parts of this unit or be the cause of personal injury.
- Do not hang onto the installed unit and avoid any impact to the unit.
- Secure the unit firmly to the wall so that it does not fall off. If the unit falls off, it may result in an injury or damage to the product.
- When the unit is installed on a wall, please make sure that a child does not pull any of connecting cables, as it may cause it to fall.

! Note

Detach the unit from the bracket as shown below.

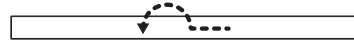

Optional equipment connection

PORT(Portable). IN connection

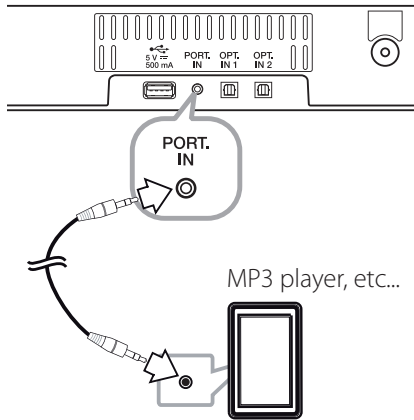

Listening to music from your portable player

The unit can be used to play the music from many types of portable player or external devices.

1. Connect the portable player to the PORT. IN connector of the unit.
2. Turn the power on by pressing .
3. Select the PORTABLE function by pressing **FUNCTION**.
4. Turn on the portable player or external device and start playing it.

OPTICAL In connection

Connect optical output of external devices to the OPT. IN 1 or OPT. IN 2 connector.

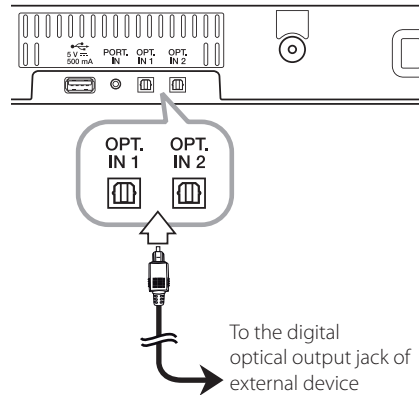

Speaker ez (easy) setup

Listens to sound from TV, DVD or Digital Device with 2.1 or 2ch mode.

1. Connect the OPT. IN 1 or OPT. IN 2 jack on the back of the unit to optical out jack of your TV (or digital device etc.)
2. Select the input source to OPTICAL 1 or OPTICAL 2 directly by pressing **OPTICAL**.
3. Listen to sound with 2.1 or 2ch speaker.
4. Press **OPTICAL** repeatedly to exit from OPTICAL. Function is returned to previous one.

! Tip

This unit turns on and selects OPTICAL function directly even in power-off state. Press **OPTICAL** on the remote control.

USB connection

Insert USB memory device to the USB port on the unit.

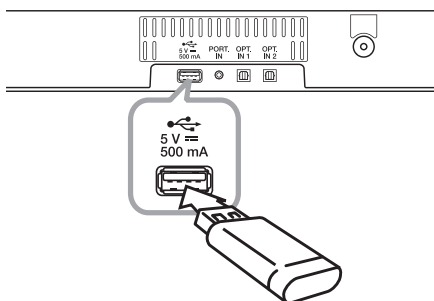

Connect a USB to the USB gender changer when the unit is mounted on the wall.

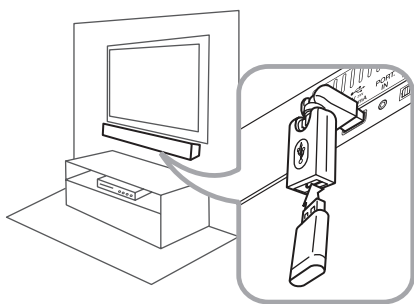

Removing the USB Device from the unit.

1. Choose a different function mode or press on the remote control or on the unit twice in a row.
2. Remove the USB device from the unit.

Playable file

MP3/WMA file requirement

MP3/WMA file compatibility with this unit is limited as follows :

- Sampling frequency : within 32 to 48 kHz (MP3), within 32 to 48 kHz (WMA)
- Bit rate : within 32 to 320 kbps (MP3), 40 to 192 kbps (WMA)
- Maximum files : Under 999
- File extensions : “.mp3”/ “.wma”
- A protected file by DRM(Digital rights management) cannot be played on the unit.

Compatible USB devices

- MP3 Player : Flash type MP3 player.
- USB Flash Drive : Devices that support USB1.1.
- The USB function of this unit does not support some USB devices.

USB device requirement

- Devices which require additional program installation connected to a computer, are not supported.
- Do not extract the USB device while in operation.
- For a large capacity USB, it may take longer than a few minutes to be searched.
- To prevent data loss, back up all data.
- This unit is not supported when the total number of files is 1000 or more.
- The unit's USB Port cannot be connected to PC. The unit can not be used as a storage device.
- The exFAT file system is not supported on this unit.
- Depending on some devices, it may not be able to recognize the followings on this unit.
 - External HDD
 - Card readers
 - Locked devices
 - Hard type USB devices
 - USB hub
 - Using USB extension cable

Basic operations

USB operation

1. Connect the USB device to the USB port.
2. Select the USB function by pressing **FUNCTION**.

To	Do this
Stop	Press ■ .
Playback	Press ▶/II .
Pause	Press ▶/II during playback.
Skipping to the next/previous file	During playback, press ◀◀ or ▶▶ to go to the next file or to return to the beginning of the current file. Press ◀◀ twice briefly to step back to the previous file.
Searching for a section within a file	Press and hold ◀◀/▶▶ during playback and release it at the point you want to listen to.
Playing repeatedly or randomly	Press REPEAT on the remote control repeatedly, the display change in the following order, RPT 1 → RPT DIR (Directory) → RPT ALL → RANDOM → OFF.
Selecting files directly	Press 0 to 9 numerical buttons on the remote control to go to the desired file directly.
Resume playback	The unit memorizes the point at which you've changed function or the unit had been turned off.

! Note

The resume point may be cleared when you pull out the power cord or removing the USB device from the unit.

Other operations

DRC (Dynamic range control)

Make the sound clear when the volume is turned down (Dolby Digital only). Set to [DRC ON] by using **DRC**.

AV Sync

When receiving audio signals from TV, sound and images may not be matched. In the case, this function can adjust the delay time.

1. Press **AV SYNC**.
2. Use **◀◀/▶▶** to scroll up and down through the delay amount, which you can set at anything between 0 and 300 ms.

Displaying file and input source

You can display various information of the input source by pressing **INFO**.

USB : MP3/WMA containing file information

OPTICAL 1/2 : Audio format, Audio channel

Turn off the sound temporarily

Press **MUTE** **✕** to mute your unit.

You can mute your unit, for example, to answer the telephone, the "MUTE" is displayed in the display window.

To cancel it, press **MUTE** **✕** again on the remote control or change the volume level.

AUTO POWER On/Off

Before operating this function, make sure that you have selected OPTICAL IN and turn on the AUTO POWER.

This function automatically turns on/off the unit when you turn on/off the external device (TV, DVD Player, Blu-ray Disc Player, etc.) connected to this unit by the optical cable.

When turning on the unit by this function, Optical function is selected directly no matter what kind of function has been selected before turning off it.

This function turns on or off each time you press **AUTO POWER**.

Display	Operation
AUTO POWER ON	AUTO POWER function is turned on.
AUTO POWER OFF	AUTO POWER function is turned off.

! Note

- This function is intentionally designed to turn off the unit after 1 minute of inactivity. If you did not connect external devices with optical cable or there is no digital audio signal going to the unit, the unit will turn off after 1 minute of inactivity if AUTO POWER function is turned on.
- Depending on the connected device by the optical cable, this function may not operate.
- Once AUTO POWER is set, the unit will start as OPTICAL mode automatically next time, no matter what kind of function you selected before.
- It is not available to turn on the unit by AUTO POWER function if you turn off the unit directly.
- AUTO POWER function is not supported on LG Sound Sync (Wireless) mode.

Auto power down

This unit will turn off itself to save electric consumption in the case where main unit is not connected to external device and is not used for 25 minutes.

So does this unit after six hours since Main unit has been connected to other device using analogue input.

But the unit can turn on automatically based on the [AUTO POWER] function you've set.

Sleep timer setting

Press **SLEEP** repeatedly to select the desired time period options (in minutes):

LCD OFF (Display window off) -> DIMMER (The display window will be darkened by half) -> Sleep timer value -> Display on

In display window you see "LCD OFF" and the display window turns off.

To check the remaining time, press **SLEEP**.

To cancel the sleep function, press **SLEEP** repeatedly until "SLEEP 10" appears, and then press **SLEEP** once again while "SLEEP 10" is displayed.

! Note

You can check the remaining time before the unit turns off. Press **SLEEP** the remaining time appears in the display window.

LG Sound Sync



You can control some functions of this unit by your TV's remote control with LG Sound Sync. It is compatible with the LG TV that is supported LG Sound Sync. Make sure of the LG Sound Sync logo on your TV.

Controllable function by LG TV's remote control :
Volume up/down, mute

Refer to the TV's instruction manual for the details of LG Sound Sync.

Make one of the following connections, depending on the capabilities of your equipment.

! Note

- You can also use the remote control of this unit while using LG Sound Sync. If you use TV's remote control again, the unit synchronizes with the TV.
- When the connections failed, make sure of the condition of the TV and power of it.
- Make sure of the condition of this unit and the connection in the cases below when using LG Sound Sync.
 - Turned off the unit.
 - Changing the function to the others.
 - Disconnecting the optical digital audio cable.
 - Disconnecting the wireless connection caused by interference or a distance.

With wired connection

1. Connect your LG TV to the unit by using an optical digital cable.

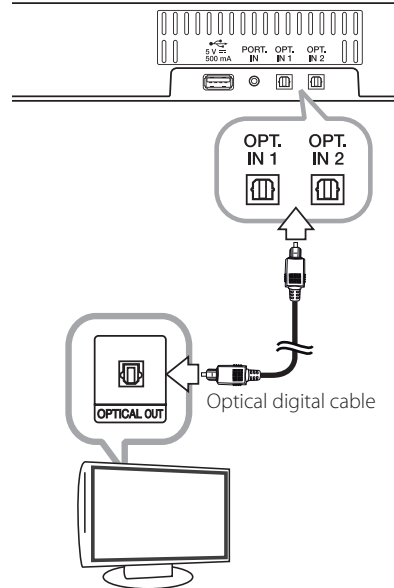

2. Set up LG Sound Sync (Optical) on the TV. Refer to the TV's instruction manual.
 3. Turn on the unit by pressing **Power** on the remote control.
 4. Select OPTICAL 1 or OPTICAL 2 function by pressing **FUNCTION** on the remote control.
- You can see "LG OPT" on the display window if connecting normally between this unit and your TV.

! Note

The amount of time to turn off this unit is different depending on your TV when you set AUTO POWER function to ON.

With wireless connection

1. Set up LG Sound Sync (Wireless) on the TV. Refer to the TV's instruction manual.
2. Turn on the unit by pressing  (Power) on the remote control.
3. Select LG TV function by pressing **FUNCTION** on the remote control.

"PAIRED" appears on the display window for about 3 seconds and then you can see "LG TV" on the display window if connecting normally between this unit and your TV.

Note

Once LG TV function is selected, the unit connects automatically the TV which is connected latest when restarting.

3

Operating

Using Bluetooth technology

About Bluetooth

Bluetooth is wireless communication technology for short range connection.

The available range is within 10 meters. (The sound may be interrupted when the connection interfered by the other electronic wave or you connect the bluetooth in the other rooms.)

Connecting individual devices under **Bluetooth®** wireless technology does not incur any charges. A mobile phone with **Bluetooth®** wireless technology can be operated via the Cascade if the connection was made via **Bluetooth®** wireless technology.

Available Devices : Mobile phone, MP3, Laptop, PDA

Bluetooth profiles

In order to use **Bluetooth®** wireless technology, devices must be able to interpret certain profiles. This unit is compatible with following profile.

A2DP (Advanced Audio Distribution Profile)

Listening to music stored on the Bluetooth devices

Pairing this unit and Bluetooth device

Before you start the pairing procedure, make sure the Bluetooth feature is turned on in your Bluetooth device. Refer to your Bluetooth device's user guide. Once a pairing operation is performed, it does not need to be performed again.

1. Select the Bluetooth function by using the **FUNCTION**.
Appears "BT" and then "BT READY" in display window.
2. Operate the Bluetooth device and perform the pairing operation. When searching for this unit with the Bluetooth device, a list of the devices found may appear in the Bluetooth device display depending on the type of Bluetooth device. Your unit appears as "LG SOUND BAR (XX:XX)".

! Note

XX:XX means the last four digits of BT address. For example, if your unit has a BT address such as 9C:02:98:4A:F7:08, you will see "LG SOUND BAR (F7:08)" on your Bluetooth device.

3. Enter the PIN code.
PIN code : 0000
4. "PAIRED" appears on the display window when this unit successfully paired with your Bluetooth device.

! Note

Depending on the Bluetooth device type, some device have a different pairing way.

5. Listen to music.
To play a music stored on your Bluetooth device, refer to your Bluetooth device's user guide.

! Note

- You should connect your Bluetooth device to this unit again when you restart it.
- The unit connects automatically to the Bluetooth device which is connected latest, when you select Bluetooth function again after changing to the other functions.
- The sound may be interrupted when the connection interfered by the other electronic wave.
- You cannot control the Bluetooth device with this unit.
- Pairing is limited one Bluetooth device per one unit and multi-pairing is not supported.
- Although the distance between your Bluetooth and the set is less than 10 m, there are obstacles between both, your Bluetooth device cannot be connected.
- Depending on the type of the device, you may not be able to use the Bluetooth function.
- You can enjoy wireless system using phone, MP3, Notebook, etc..
- When not connected the Bluetooth, "BT READY" appears on the display window.
- The Electrical malfunction due to devices using same frequency such as Medical equipment, Microwaves or wireless LAN devices, the connection will be disconnected.
- When someone stands and interrupts communication between Bluetooth device and the player, the connection will be disconnected.
- If the gotten away of the distance between Bluetooth and the unit, the sound quality is lower and lower the connection will disconnect when the space between the Bluetooth and the unit gets out of the operating range of Bluetooth.
- The device with **Bluetooth®** wireless technology is disconnected, if you turn off the main unit or put the device away from the main unit more than 10 m.

Sound adjustment

Setting the surround mode

This system has a number of pre-set surround sound fields. You can select a desired sound mode by using **SOUND EFFECT**.

The displayed items for the equalizer may be different depending on sound sources and effects.

On Display	Description
NATURAL	You can enjoy comfortable and natural sound.
BYPASS	You can enjoy the sound without equalizer effect.
BASS	The BASS is Bass Blast. During playback, reinforce the treble, bass and surround sound effect.
CLRVOICE	The CLRVOICE is Clear Voice. This program make voice sound clear, improving the quality of voice sound.
GAME	The GAME is Game Equalizer. You can enjoy more virtual sound while playing video games.
NIGHT	The NIGHT is Night Mode. This may be useful when you want to watch movies at low volume late at night.
UPSCALER	The UPSCALER is MP3 Up-Scaling. When listening to MP3 files or other compressed music, you can enhance the sound. This mode is available only to 2 channel sources.
LOUDNESS	Improves the bass and treble sound.
3D SOUND	3D Sound features deliver sound creating a wider spot so you can enjoy more immersive and cinematic surround sound.

Note

- In some of surround modes, some speakers, there's no sound or low sound. It depends on the mode of surround and the source of audio, it is not defective.
- You may need to reset the surround mode, after switching the input, sometimes even after the sound file changed.

Auto volume On/Off

This unit supports Auto volume function that automatically adjusts the volume level.

When the output sound is too loud or too low, press **AUTO VOLUME** on the remote control. So you can enjoy the sound with appropriate levels.

To cancel this function, press the button again.

Adjust the woofer level settings

You can adjust the sound level of woofer.

1. Press **WOOFER LEVEL**.
2. Press **-/+ VOL** to adjust the sound level of the woofer.

Controlling a TV with the supplied remote control

You can control your TV using the buttons below.

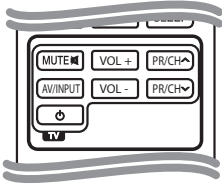

Button	Operation
MUTE ✕	Turn the TV's volume on or off
AV/INPUT	Switch the TV's input source between the TV and other input sources.
⏻ (TV POWER)	Turn the TV on or off.
VOL +/-	Adjust the volume of the TV.
PR/CH ▲ / ▼	Scan up or down through memorized channels.

! Note

Depending on the unit being connected, you may not be able to control your TV using some of the buttons.

Setting up the remote to control your TV

You can operate your TV with the supplied remote control.

If your TV is listed in the table below, set the appropriate manufacturer code.

1. While holding down ⏻ (TV POWER) button, and press the manufacturer code for your TV with the numerical buttons (see the table below).

Manufacturer	Code Number
LG	1(Default), 2
Zenith	1, 3, 4
GoldStar	1, 2
Samsung	6, 7
Sony	8, 9
Hitachi	4

2. Release the ⏻ (TV POWER) button to complete setting.

Depending on your TV, some or all buttons may not function on the TV, even after entering the correct manufacturer code. When you replace the batteries of the remote, the code number you have set may be reset to the default setting. Set the appropriate code number again.

Troubleshooting

PROBLEM	CAUSE & CORRECTION
No Power	<ul style="list-style-type: none"> The power cord is unplugged. Plug in the power cord. Check the condition by operating other electronic devices.
No sound	<ul style="list-style-type: none"> Incorrect input source is selected. Check the input source and select the correct input source. The mute function is activated. Press MUTE or adjust the volume level to cancel the mute function.
Display window is dark.	<ul style="list-style-type: none"> The Dimmer or the Sleep function is activated. Press SLEEP to cancel the function.
The remote control does not work properly.	<ul style="list-style-type: none"> The remote control is too far from the unit. Operate the remote control within about 23 ft (7 m). There is an obstacle in the path of the remote control and the unit. Remove the obstacle. The batteries in the remote control is exhausted. Replace the batteries with new ones.
The Auto power on/off function does not work.	<ul style="list-style-type: none"> Depending on the connected device by the optical cable, this function may not operate.
When you sense that outputted sound of the unit is low.	<p>Check the details below and adjust the unit according to them.</p> <ul style="list-style-type: none"> Switch [ON] state of DRC function to [OFF] by using remote controller. With the sound bar connected with TV, change the AUDIO DIGITAL OUT setting on TV Setup Menu from [PCM] to [AUTO] or [BITSTREAM]. With the sound bar connected with Player, change the AUDIO DIGITAL OUT setting on Player Setup Menu from [PCM] to [PRIMARY PASS-THROUGH] or [BITSTREAM]. Change Audio DRC setting on Player setup menu to [OFF] state.

Trademarks and licenses



Manufactured under license from Dolby Laboratories. Dolby and the double-D symbol are trademarks of Dolby Laboratories.



Manufactured under license under U.S. Patent Nos: 5,956,674; 5,974,380; 6,487,535 & other U.S. and worldwide patents issued & pending. DTS, the Symbol, & DTS and the Symbol together are registered trademarks & DTS 2.0 Channel is a trademark of DTS, Inc. Product includes software. © DTS, Inc. All Rights Reserved.



Bluetooth® wireless technology is a system which allows radio contact between electronic devices within a max. range of 10 meters.

Connecting individual devices under **Bluetooth**® wireless technology does not incur any charges. A mobile phone with **Bluetooth**® wireless technology can be operated via the Cascade if the connection was made via **Bluetooth**® wireless technology.

The **Bluetooth**® word mark and logos are owned by the **Bluetooth**® SIG, Inc. and any use of such marks by LG Electronics is under license.

Other trademarks and trade names are those of their respective owners.

Maintenance

Handling the unit

When shipping the unit

Please save the original shipping carton and packing materials. If you need to ship the unit, for maximum protection, re-pack the unit as it was originally packed at the factory.

Keeping the exterior surfaces clean

- Do not use volatile liquids such as insecticide spray near the unit.
- Wiping with strong pressure may damage the surface.
- Do not leave rubber or plastic products in contact with the unit for a long period of time.

Cleaning the unit

To clean the player, use a soft, dry cloth. If the surfaces are extremely dirty, use a soft cloth lightly moistened with a mild detergent solution. Do not use strong solvents such as alcohol, benzine, or thinner, as these might damage the surface of the unit.

Specifications

General	
Power requirements	AC 120 V, 60 Hz
Power consumption	18 W
Dimensions (W x H x D)	950 mm x 99 mm x 57 mm (37.4" x 3.9" x 2.2")
Net Weight (Approx.)	3.5 kg
Operating temperature	41 °F to 95 °F (5 °C to 35 °C)
Operating humidity	5 % to 90 %

Inputs	
Optical input	3.0 Vrms (p-p), Optical jack x 2
Portable input	0.5 Vrms (3.5 mm stereo jack)

USB	
USB Version	USB 1.1
Bus Power Supply	DC 5 V  500 mA

Amplifier	
Total output	100 W
Stereo mode	18 W + 18 W (4 Ω at 1 kHz)
Subwoofer : Built-In	64 W (4 Ω at 110 Hz)
THD	10 %

- Designs and specifications are subject to change without prior notice.





LG Customer Information Center

1-800-243-0000 USA, Consumer
1-888-865-3026 USA, Commercial

Register your product Online!

www.lg.com

Printed in china