



ENGLISH

# OWNER'S MANUAL

## Micro Hi-Fi System

Please read this manual carefully before operating your set and retain it for future reference.

CM2031 (CM2031, CMS2031F)



MFL67840986

## Safety Information



**CAUTION:** TO REDUCE THE RISK OF ELECTRIC SHOCK DO NOT REMOVE COVER (OR BACK) NO USER-SERVICEABLE PARTS INSIDE REFER SERVICING TO QUALIFIED SERVICE PERSONNEL.



This lightning flash with arrowhead symbol within an equilateral triangle is intended to alert the user to the presence of uninsulated dangerous voltage within the product's enclosure that may be of sufficient magnitude to constitute a risk of electric shock to persons.



The exclamation point within an equilateral triangle is intended to alert the user to the presence of important operating and maintenance (servicing) instructions in the literature accompanying the product.

**WARNING:** TO PREVENT FIRE OR ELECTRIC SHOCK HAZARD, DO NOT EXPOSE THIS PRODUCT TO RAIN OR MOISTURE.

**WARNING:** Do not install this equipment in a confined space such as a book case or similar unit.

**CAUTION:** Do not block any ventilation openings. Install in accordance with the manufacturer's instructions.

Slots and openings in the cabinet are provided for ventilation and to ensure reliable operation of the product and to protect it from over heating. The openings shall be never be blocked by placing the product on a bed, sofa, rug or other similar surface. This product shall not be placed in a built-in installation such as a bookcase or rack unless proper ventilation is provided or the manufacturer's instruction has been adhered to.

**NOTICE :** For safety marking information including product identification and supply ratings, please refer to the main label on the bottom of the apparatus.



**CAUTION:** This product employs a Laser System. To ensure proper use of this product, please read this owner's manual carefully and retain it for future reference. Shall the unit require maintenance, contact an authorized service centre. Use of controls, adjustments or the performance of procedures other than those specified herein may result in hazardous radiation exposure. To prevent direct exposure to laser beam, do not try to open the enclosure.

### CAUTION concerning the Power Cord

Most appliances recommend they be placed upon a dedicated circuit;

That is, a single outlet circuit which powers only that appliance and has no additional outlets or branch circuits. Check the specification page of this owner's manual to be certain. Do not overload wall outlets. Overloaded wall outlets, loose or damaged wall outlets, extension cords, frayed power cords, or damaged or cracked wire insulation are dangerous. Any of these conditions could result in electric shock or fire. Periodically examine the cord of your appliance, and if its appearance indicates damage or deterioration, unplug it, discontinue use of the appliance, and have the cord replaced with an exact replacement part by an authorized service centre. Protect the power cord from physical or mechanical abuse, such as being twisted, kinked, pinched, closed in a door, or walked upon. Pay particular attention to plugs, wall outlets, and the point where the cord exits the appliance. To disconnect power from the mains, pull out the mains cord plug. When installing the product, ensure that the plug is easily accessible.

This device is equipped with a portable battery or accumulator.

**Safety way to remove the battery or the battery from the equipment:** Remove the old battery or battery pack, follow the steps in reverse order than the assembly. To prevent contamination of the environment and bring on possible threat to human and animal health, the old battery or the battery put it in the appropriate container at designated collection points. Do not dispose of batteries or battery together with other waste. It is recommended that you use local, free reimbursement systems batteries and accumulators. The battery shall not be exposed to excessive heat such as sunshine, fire or the like.

**CAUTION:** The apparatus shall not be exposed to water (dripping or splashing) and no objects filled with liquids, such as vases, shall be placed on the apparatus.

### Disposal of your old appliance



1. When this crossed-out wheeled bin symbol is attached to a product it means the product is covered by the European Directive 2002/96/EC.
2. All electrical and electronic products should be disposed of separately from the municipal waste stream via designated collection facilities appointed by the government or the local authorities.
3. The correct disposal of your old appliance will help prevent potential negative consequences for the environment and human health.
4. For more detailed information about disposal of your old appliance, please contact your city office, waste disposal service or the shop where you purchased the product.

- The appliance is not intended for use by young children or infirm persons without supervision.
- Young Children should be supervised to ensure that they do not play with appliance.
- If the appliance is supplied from a cord extension set or an electrical portable outlet device, the cord extension set on electrical portable outlet device must be positioned so that it is not subject to splashing or ingress of moisture.

### Disposal of waste batteries/accumulators



1. When this crossed-out wheeled bin symbol is attached to batteries/accumulators of Your product it means they are covered by European Directive 2006/66/EC.
2. This symbol may be combined with chemical symbols for mercury(Hg), cadmium(Cd) or lead(Pb) if the battery Contains more than 0.0005% of mercury, 0.002% of cadmium or 0.004% of lead.
3. All batteries/accumulators should be disposed separately from the municipal waste stream via designated collection facilities appointed by the government or the local authorities.
4. The correct disposal of Your old batteries/accumulators will help to prevent potential negative consequences for the environment, animal and human health.
5. For more detailed information about disposal of Your old batteries/accumulators, please contact Your city office, waste disposal service or the shop where You purchased the product.



LG Electronics hereby declares that this/these product(s) is/are in compliance with the essential requirements and other relevant provisions of Directive 2004/108/EC, 2006/95/EC, 2009/125/EC and 2011/65/EU.

#### **Contact office for compliance of this product :**

LG Electronics Inc.  
EU Representative, Krijgsman 1,  
1186 DM Amstelveen, The Netherlands

Please note that this is NOT a Customer Service contact point. For Customer Service Information, see Warranty Card or contact the dealer that you purchased this product.

# Table of Contents

## 1 Getting Started

---

- 2 Safety Information
- 6 Unique Features
- 6 Accessories
- 7 Playable file Requirement
- 7 – MP3/WMA music file requirement
- 7 – Compatible USB Devices
- 7 – USB device requirement
- 8 Remote Control
- 10 Front Panel
- 11 Rear Panel

## 2 Connecting

---

- 12 Connecting to speakers
- 12 – Connecting the speakers to the unit
- 12 Antenna Connection
- 13 Optional Equipment Connection
- 13 – USB Connection
- 13 – PORT. IN Connection
- 13 – Listening to music from your external device

## 3 Operating

---

- 14 Basic Operations
- 14 CD/USB Operations
- 14 – Selecting a folder
- 15 Other Operations
- 15 – Programmed Playback
- 15 – Displaying file information (ID3 TAG)
- 15 – Turn off the sound temporarily
- 15 – Setting the BASS and TREBLE
- 16 Advanced Operations
- 16 – Playing the iPhone/iPod
- 17 – Compatible iPhone/iPod
- 18 Radio Operations
- 18 – Listening to the radio
- 18 – Presetting the Radio Stations
- 18 – Improving poor FM reception
- 18 – Deleting all the saved stations
- 19 Setting the Clock
- 19 – Setting the alarm
- 20 – Sleep Timer Setting
- 20 – Dimmer
- 20 – Auto Power Down

## 4 Troubleshooting

---

- 21 Troubleshooting

## 5 Appendix

---

- 22 Specifications
- 23 Maintenance
- 23 – Handling the Unit
- 23 – Notes on Discs

1

2

3

4

5

## Unique Features

### Portable In

Listens to music from your portable device.  
(MP3, Notebook, etc)

### Radio

Listens to the radio.

### USB

Listens to music from your USB device.

### BASS and TREBLE effect

Listen to music with the Bass and Treble effect.

### Alarm

Sets alarm which go off at desired time.

### iPhone/iPod

Listens to music from your iPhone/iPod device.

## Accessories

Please check and identify the supplied accessories.

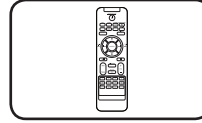

Remote Control (1)

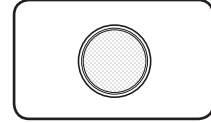

Battery (1)

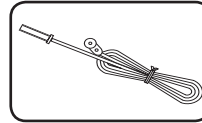

FM Antenna (1)

# Playable file Requirement

## MP3/WMA music file requirement

MP3/WMA file compatibility with this unit is limited as follows.

- Sampling Frequency : 8 - 48 kHz (MP3), 8 - 48 kHz (WMA)
- Bit rate : 32 - 384 kbps (MP3), 32 - 384 kbps (WMA)
- Maximum files : Under 999
- File extensions : ".mp3"/ ".wma"
- CD-ROM file format : ISO 9660/JOLIET
- We recommend that you use "Easy-CD Creator", which creates an ISO 9660 file system.
- You have to set the disc format option to [Mastered] in order to make the discs compatible with the LG players when formatting rewritable discs. When setting the option to Live File System, you cannot use it on LG players. (Mastered/Live File System : Disc format system for Windows Vista)

## Compatible USB Devices

- MP3 Player : Flash type MP3 player.
- USB Flash Drive :  
Devices that support USB 2.0 or USB 1.1.
- The USB function of this unit does not support all USB devices.

## USB device requirement

- Devices which require additional program installation when you have connected it to a computer, are not supported.
- Do not extract the USB device while in operation.
- For a large capacity USB, it may take longer than a few minute to be searched.
- To prevent data loss, back up all data.
- If you use a USB extension cable or USB hub, the USB device is not recognized.
- Using NTFS file system is not supported. (Only FAT(16/32) file system is supported.)
- This unit is not supported when the total number of files is 1 000 or more.
- External HDD, Card readers, Locked devices, or hard type USB devices are not supported.
- USB port of the unit cannot be connected to PC. The unit cannot be used as a storage device.
- Some USB may not work with this unit.

# Remote Control

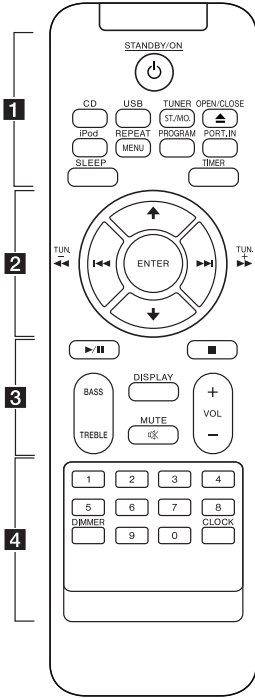

..... **1** .....

**STANDBY/ON** : Switches the unit ON or OFF.

**CD** : Selects the CD function.

**USB** : Selects the USB function.

**TUNER/ST./MO.** :

- Selects the TUNER function.
- Selects Mono/Stereo.

**▲OPEN/CLOSE** : Opens and closes the disc tray.

**iPod** : Selects the iPod function.

**REPEAT/MENU** :

- Listens to your tracks/files repeatedly or randomly.
- Move to the previous menu on IPOD mode.

**PROGRAM** :

- Stores radio stations.
- Creates a playlist you want to listen to.

**PORT.IN** : Selects the portable function.

**SLEEP** : Sets the system to turn off automatically at a specified time.

**TIMER** : With the TIMER function you can turn DISC, USB play and TUNER reception on or off at a desired time.

..... **2** .....

**ENTER** :

- Confirms the setting.
- Choose an item on IPOD mode.

**▲/▼** :

- Searches for a folder of MP3/WMA files. When a CD/ USB containing MP3/WMA files in several folders is being played, press ▲/▼ to select the folder you want to play.

- Choose a preset number for a radio station.

**⏪/⏩** (Skip) : Goes to next or previous track/file.

**⏮/⏭** (Search) : Searches backward or forward.

**TUN. -/+** : Selects the radio station.

..... **3** .....

**▶/⏸** (Play/Pause) : Starts or pauses playback.

**■** : Stops playback.

**BASS/TREBLE** : Adjust bass and treble effect.

**DISPLAY** : Sees informations about your music. MP3 files often come with ID3 tags. The tag gives the Title, Artist, Album or Time information.

**MUTE** : Mutes the sound.

**VOL +/-** : Adjusts speaker volume.

..... **4** .....

**0 to 9 numerical buttons** :

Selects a desired track/file directly.

**DIMMER** : Darkens the display window.

**CLOCK** : Sets the clock and checks the time.



## Battery Installation

When you use the remote control first, remove the insulation.

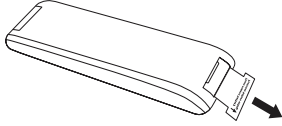

1. Open the battery case.

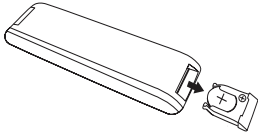

2. Press the edge of the battery (the dotted section on the illustration below) and remove the battery.



3. Turn the battery case upside-down, then insert a new battery with the (+) facing in the same direction as the (+) on the battery case. Press it gently as follows.

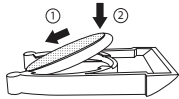

4. Close the battery case.

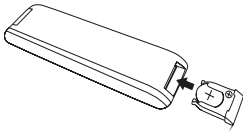

### Caution

The battery used in this device may present a fire or chemical burn hazard if mistreated. Do not recharge, disassemble, incinerate, or heat above 100 °C (212 °F). Replace the battery part no. CR2025 only. Use of another battery may present a risk of fire or explosion. Dispose of used battery. Keep battery away from children. Do not disassemble or dispose of in fire.

### Note

Do not pull the battery in the direction shown on the illustration below.

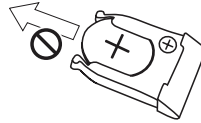

# Front Panel

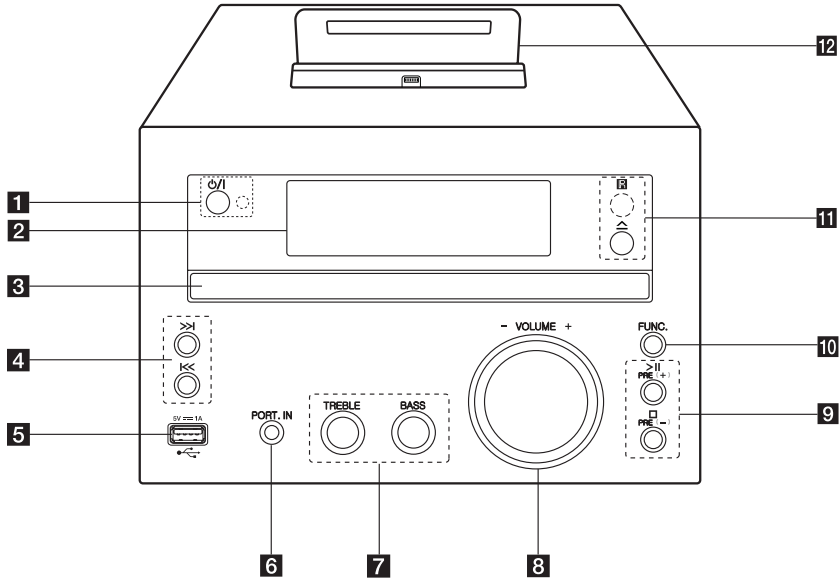

- 1** **⏻/⏻** (Power ON/OFF)  
Switches the unit ON or OFF.  
LED Indicator  
LED lights up in stand by mode.
- 2** Display window
- 3** Disc tray  
Load a disc.
- 4** **⏮/⏭** (Skip/Search)  
- Searches backward or forward.  
- Skips to the previous/next chapter/track/file.  
- Tunes in the desired radio station.
- 5** USB Port  
Plays the audio files by connecting the USB device.
- 6** **PORT. IN**  
Listens to music from your portable device.
- 7** **TREBLE/BASS**  
Listens to the music with the desired sound effect by adjusting treble and bass.
- 8** **VOLUME-/+**  
Adjusts volume of speaker.
- 9** **>||**  
Starts or pauses playback.  
**□**  
Stops playback.  
**PRE(+)/PRE(-)**  
Selects preset numbers.
- 10** **FUNC.**  
Selects the function and input source.
- 11** **△** (Open/Close)  
Opens and closes the disc tray.
- R**  
Remote sensor
- 12** iPod/iPhone Dock  
Connects an iPod/iPhone.

## Rear Panel

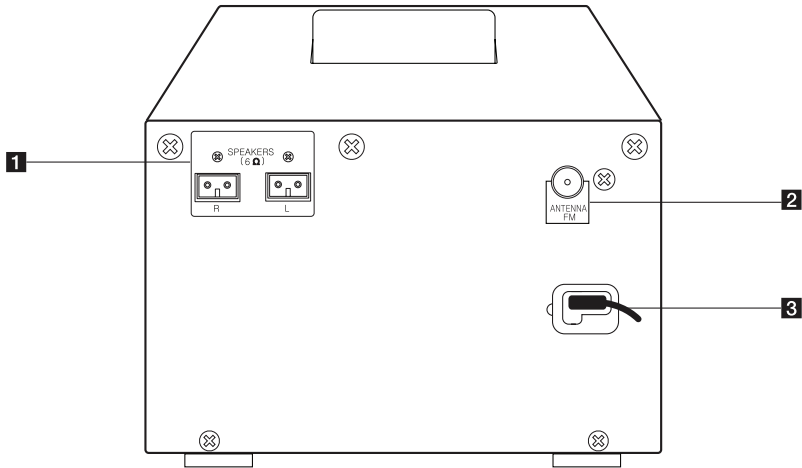

- 1** SPEAKERS connector (R/L)
- 2** ANTENNA FM
- 3** Power cord

## Connecting to speakers

### Connecting the speakers to the unit

Connect the speaker cable to the SPEAKER connector.

Connect a right plug to the **R** connector and a left plug to the **L** connector.

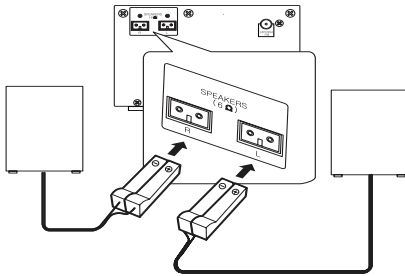

#### ! Caution

The speakers contain magnet parts, so color irregularity may occur on the TV screen or PC monitor screen. Please use the speakers far away from either TV screen or PC monitor.

Connector	Speaker	Position
R	Front	Front right
L	Front	Front left

## Antenna Connection

Connect the supplied FM antenna for listening to the radio.

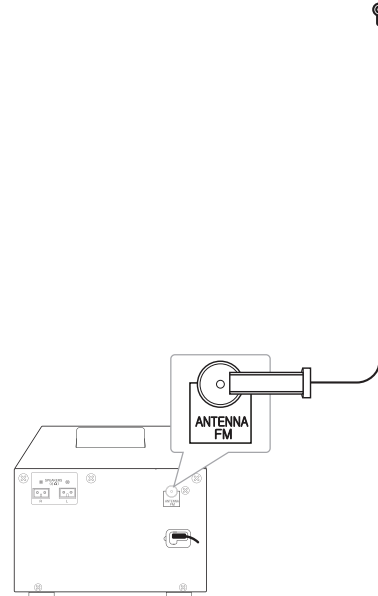

#### ! Note

Be sure to fully extend the FM wire antenna.

## Optional Equipment Connection

### USB Connection

Connect the USB Memory (or MP3 player, etc.) to the USB port on the front of the unit.

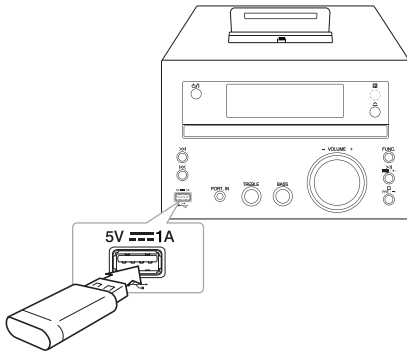

#### Note

- Removing the USB Device from the unit
  1. Choose a different function/mode or press **■** on the remote control or **□** on the unit twice in a row.
  2. Remove the USB device from the unit.

### PORT. IN Connection

Connect an output (earphone or line out) of portable device (MP3 or PMP etc) to the PORT. IN connector.

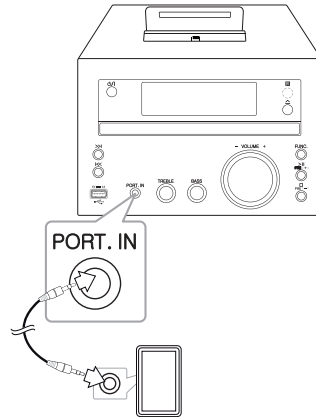

### Listening to music from your external device

The unit can be used to play the music from many types of external device.

1. Connect the external device to the PORT. IN connector of the unit.
2. Turn the power on by pressing **⏻** (Power ON/OFF).
3. Select the PORTABLE function by pressing **FUNC.** on the unit or **PORT.IN** on the remote control.
4. Turn the external device and start playing music.

## Basic Operations

### CD/USB Operations

1. Insert the disc by pressing **▲OPEN/CLOSE** on the remote control or **△** on the unit.  
Or connect the USB device to the USB port.
2. Select the CD or USB function by pressing **CD** or **USB** on the remote control or **FUNC.** on the unit.
3. Select a track/file you want to play by pressing **◀◀/▶▶** on the remote control or **◀◀/▶▶** on the unit.

3

Operating

To	Do this
Stop	Press <b>■</b> on the remote control or on the unit.
Playback	Press <b>▶/  </b> on the remote control or <b>&gt;  </b> on the unit.
Pause	During playback, press <b>▶/  </b> on the remote control or <b>&gt;  </b> on the unit.
Skip to the next/previous track/file	During playback, press <b>▶▶</b> on the remote control or <b>&gt;&gt; </b> on the unit to go to the next track/file. Playing less than 2 seconds, press <b>◀◀</b> on the remote control or <b>◀◀</b> on the unit to go to the previous track/file. Playing after 3 seconds, press <b>◀◀</b> on the remote control or <b>◀◀</b> on the unit to go to the beginning of the track/file.
Search for a section within a track	Press and hold <b>◀◀/▶▶</b> on the remote control or <b>◀◀/▶▶</b> on the unit during playback and release it at the point you want to listen to.
Play repeatedly or randomly	Press <b>REPEAT/MENU</b> on the remote control repeatedly, the display change in the following order. REPEAT1 -> REPEAT GROUP(Only MP3) -> REPEAT -> RAND. (RANDOM) -> OFF

#### ! Note

- If you play back disc with scratches / imperfections on surface you may experience some noise or possible failure to read or detect disc.
- The DTS is not supported.

### Selecting a folder

1. Press **▲/▼** on the remote control repeatedly until a desired folder appears.
2. Press **▶/||** on the remote control or **>||** on the unit to play it. The first file of folder will play.

#### ! Note

- USB and CD Folders/Files are recognized as below.

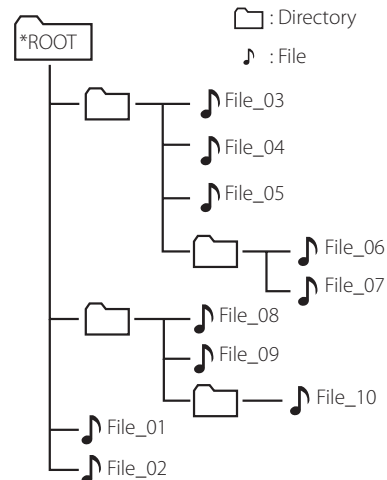

- Files and folders will be presented in order recorded and may be presented differently according to the record circumstances.
- Folders will be presented as the following order;  
FAT(USB) : FILE\_01 -> FILE\_02 -> FILE\_03 -> FILE\_04 -> FILE\_05 -> **FILE\_06 -> FILE\_07 -> FILE\_08 -> FILE\_09 -> FILE\_10**  
CD : FILE\_01 -> FILE\_02 -> FILE\_03 -> FILE\_04 -> FILE\_05 -> **FILE\_08 -> FILE\_09 -> FILE\_06 -> FILE\_07 -> FILE\_10**
- \*ROOT : the first screen you can see when a computer recognize the USB is "ROOT"

## Other Operations

### Programmed Playback

The program function enables you to store your favorite files from any disc or USB device.

A program can contain 20 tracks/files.

1. Insert a CD or a USB and wait for it to be ordered.
2. Press **PROGRAM** on the remote control in stop status.
3. Press **◀◀/▶▶** on the remote control or **◀◀/▶▶** on the unit to select a track/file.
4. Press **PROGRAM** on the remote control again to save and select a next track/file.
5. Press **▶/||** on the remote control or **▶||** on the unit to play the programmed music tracks/files.
6. To clear your selection, press **■** on the remote control or **□** on the unit twice.

#### Note

The programs are also cleared when the disc or USB device is removed, the unit is powered off or the function is switched to others.

### Displaying file information (ID3 TAG)

While playing an MP3 file containing file information, you can display the information by pressing **DISPLAY**.

### Turn off the sound temporarily

Press **MUTE** on the remote control to mute your sound.

You can mute your sound, for example, to answer the telephone, "MUTE" will appear and blink in the display window.

To cancel it, press **MUTE** again or change the volume level.

### Setting the BASS and TREBLE

You can listen to music with the bass and treble effect by using the **BASS** and **TREBLE**.

Remote Control : Press **BASS/TREBLE**. Then "BASS/TREB" is displayed. Press **VOL+/-** to select the sound level you want.

Unit : Turn **BASS/TREBLE** right and left. Then "BASS/TREB" is displayed.

On Display	Description
BASS	Reinforce bass sound effect.
TREB(TREBLE)	Reinforce treble sound effect.

# Advanced Operations

## Playing the iPhone/iPod

You can enjoy the sound with your iPhone/iPod. For details about iPhone/iPod, refer to the iPhone/iPod User Guide.

### To connect iPhone/iPod to Dock

1. If you have Lightning Connector of ipod/iphone, Connect the iPhone/iPod to iPhone/iPod Dock.  
Your iPhone/iPod will be automatically turned on and start recharging
2. Turn the unit on.
3. Press **FUNC.** on the unit or **iPOD** on the remote control to select IPOD function.
4. You can use your iPhone/iPod by using the remote control and using your iPhone/iPod.

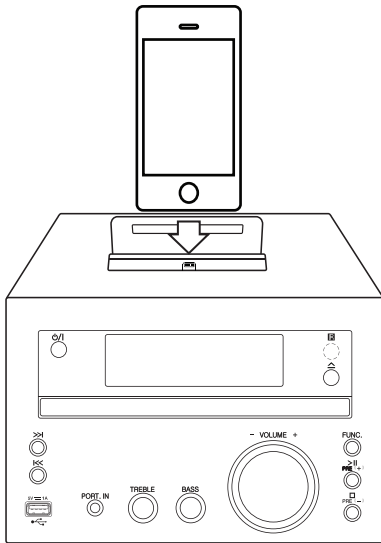

### To connect iPhone/iPod to USB cable

1. If you have 30 pin of iphone/ipod, use USB cable to connect your iphone/ipod to the unit
2. Turn the unit on.
3. Press **FUNC.** on the unit or **iPOD** on the remote control to select USB function. "USB/IPOD" will appear in the display window.
4. You can use your iPhone/iPod by using the remote control and using your iPhone/iPod.

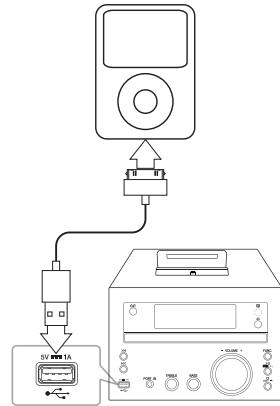

3 Operating

To	Do this	
	ON UNIT	ON REMOTE
Pause or restart	>	▶/
Skip	<</>>	◀◀/▶▶
Search	Press and hold  <</>>	Press and hold ◀◀/▶▶
Move to the previous menu	-	REPEAT/MENU
Move to the desired item	-	⬆/⬇
Choose an item	□	ENTER



## Compatible iPhone/iPod

We recommend installing the latest software version.

The unit supports the models as follows.

iPhone 5, iPhone 4S, iPhone 4, iPhone 3GS,  
iPod touch (3rd through 5th generation),  
iPod nano (4th through 7th generation)

Depending on your iPod/iPhone's software version, you may not control your iPod/iPhone from the unit.

iPhone, iPod nano, and iPod touch are trademarks of Apple Inc., registered in the U.S. and other countries. Lightning is a trademark of Apple Inc.

### Note

- When the unit is turned off, iPhone/iPod can recharge, using iPhone/iPod Dock but When the unit is turned off, iPhone/iPod can't recharge, using iPhone/iPod cable.
- An error occur as below.
  - Your iPhone/iPod is not connected firmly.
  - This unit recognizes your iPhone/iPod as an unknown device.
  - Your iPhone/iPod is exceptionally low in power.
    - ➔ The battery needs to be charged.
    - ➔ If you charge the battery while iPhone/iPod is extremely low in power, it may take longer to be charged.
- Depending on your iPhone/iPod's software version, it may not be possible to control your iPhone/iPod from this unit. We recommend installing the latest software version.
- If you use an application, make a call, or send and receive SMS text message, etc. on iPod touch or iPhone, disconnect it from iPod dock of this unit and then use it.
- If you have a problem with your iPod/iPhone, please visit [www.apple.com/support](http://www.apple.com/support).

## Radio Operations

### Listening to the radio

1. Press **TUNER/ST./MO.** on the remote control or **FUNC.** on the unit until FM appears in the display window.  
The last received station is tuned in.
2. Auto tuning : Press **TUN. -/+** on the remote control or **|<< / >>|** on the unit for about 2 seconds until the frequency indication starts changing, then release. Scanning stops when the unit tunes in a station.  
Manual tuning: Press **TUN. -/+** on the remote control or **|<< / >>|** on the unit repeatedly.
3. Adjust the volume by using **VOL+/-** on the remote control or **VOLUME-/+** on the unit repeatedly.

3

Operating

### Presetting the Radio Stations

You can preset 50 stations for FM.

Before tuning, make sure to turn down the volume.

1. Press **TUNER/ST./MO.** on the remote control or **FUNC.** on the unit until FM appears in the display window.
2. Select the desired frequency by pressing **TUN. -/+** on the remote control or **|<< / >>|** on the unit.
3. Press **PROGRAM**. A preset number will blink in the display window.
4. Press **▲/▼** on the remote control or **PRE(+)/PRE(-)** on the unit to select the preset number you want.
5. Press **PROGRAM**. The station is stored.
6. Repeat steps 2 to 5 to store other stations.
7. To listen a preset station, press **▲/▼** on the remote control or **PRE(+)/PRE(-)** on the unit.

### Improving poor FM reception

Press **TUNER/ST./MO.** on the remote control. This will change the tuner from stereo to mono. Then the reception will be better than before.

### Deleting all the saved stations

1. Press and hold **PROGRAM** for two seconds. "ERASE" will blink in the display window.
2. Press **PROGRAM** to erase all saved radio stations.

## Setting the Clock

1. Turn the unit on or off.
2. Press and hold **CLOCK** for at least 2 seconds.
3. Choose time mode by pressing **◀◀/▶▶**.
  - 12 HOUR (for an AM and PM display)
  - or 24 HOUR (for a 24 hour display)
4. Press **CLOCK** to confirm your selection.
5. Select the hours by pressing **◀◀/▶▶**.
6. Press **CLOCK**.
7. Select the minutes by pressing **◀◀/▶▶**.
8. Press **CLOCK**.
9. If you want to reset the clock, repeat steps 2-8.

## Setting the alarm

You can use the unit as an alarm clock.  
You have to set the clock before setting the alarm.

1. Turn the unit on.
2. Press and hold **TIMER**. Alarm sound sources will blink.
3. Select the one you want and press **TIMER** to save.  
(TUNER/CD/USB)
4. "ON TIME" will be displayed. This is your desired time to the unit turns on.  
Press **◀◀/▶▶** to change the hours and minutes and press **TIMER** to save.
5. The "OFF TIME" will be displayed. This is your desired time to the unit turns off.  
Press **◀◀/▶▶** to change the hours and minutes and press **TIMER** to save.
6. Press **◀◀/▶▶** to change the volume and press **TIMER** to save.
7. You can check the setting status.
8. If you want to reset the alarm, repeat steps 2-6.

### ! Note

- If you have activated the alarm before, you can check alarm information by pressing **TIMER** in stand by mode.
- In power-on mode, press **TIMER** to deactivate alarm
- In power-on mode, press **TIMER** to activate alarm. Then you can see alarm information and alarm icon .

## Sleep Timer Setting

Press **SLEEP** repeatedly and **ENTER** to select delay time between 15 and 90 minutes. After the delay time, the unit will be turned off. (You can see the following order, 15 ->30 -> 45 -> 60 -> 90->OFF)

To cancel the sleep function, press **SLEEP** repeatedly until "SLEEPOFF" appears.

### Note

- You can check the remaining time before the unit is turned off.
- Press **SLEEP**. The remaining time appears in the display window.

3

Operating

## Dimmer

Press **DIMMER** once. The display window will be darkened by half. To cancel it, press **DIMMER** once more.



## Auto Power Down

This unit will be off itself to save electronic consumption in the case main unit is not connected to external device and is not used for 25 minutes. So does this unit after 6 hours since Main unit has been connected to other device using analog input.

# Troubleshooting

Problem	Cause & Correction
No Power.	<ul style="list-style-type: none"> <li>• The power cord is not plugged in. Plug in the power cord.</li> <li>• Check whether electricity failed. Check the condition by operating other electronic devices.</li> </ul>
No sound.	<ul style="list-style-type: none"> <li>• Check whether you select the right function. Press <b>FUNC.</b> and check the selected function.</li> <li>• Speaker cables are not connect correctly. Connect the speaker cables correctly.</li> <li>• The volume is set to minimum. Use the <b>VOLUME -/+</b> to adjust the volume.</li> </ul>
The unit does not start playback.	<ul style="list-style-type: none"> <li>• An unplayable disc is inserted. Insert a playable disc.</li> <li>• No disc is inserted. Insert a disc.</li> <li>• The disc is dirty. Clean the disc. (Refer to the page 23)</li> <li>• The disc is inserted upside down. Place the disc with the label or printed side facing upwards.</li> </ul>
Radio stations cannot be tuned in properly.	<ul style="list-style-type: none"> <li>• The antenna is positioned poorly. Adjust its position.</li> <li>• The signal strength of the radio station is too weak. Tune to the station manually.</li> <li>• No stations have been preset or preset stations have been cleared (when being tuned by scanning preset channels). Preset some radio stations, see page 18 for details.</li> </ul>
The remote control does not work properly.	<ul style="list-style-type: none"> <li>• The remote control is not pointed at the remote sensor of the unit. Point the remote control at the remote sensor of the unit.</li> <li>• The remote control is too far from the unit. Operate the remote control within about 16 ft (5 m).</li> <li>• There is an obstacle in the path of the remote control and the unit. Remove the obstacle.</li> <li>• The battery in the remote control is exhausted. Replace the battery with new one.</li> </ul>
iPod/iPhone does not work.	<ul style="list-style-type: none"> <li>• Check whether the iPod/iPhone is connected to the unit correctly. Connect it to the unit correctly.</li> </ul>

## Specifications

General	
Power supply	Refer to the main label.
Power consumption	Refer to the main label.
Net Weight	1.4 kg
External dimensions (W x H x D)	160 mm x 125 mm x 250 mm
Operating conditions Temperature	5 °C to 35 °C (41 °F to 95 °F)
Operating humidity	5 % to 85 %
Bus Power Supply	USB : DC 5 V  1 A iPod/iPhone : DC 5 V  1 A

Tuner	
FM Tuning Range	87.5 to 108.0 MHz or 87.50 to 108.00 MHz

Amplifier	
Output Power	20 W + 20 W

CD	
Frequency Response	40 Hz to 20 kHz
Signal-to-noise ratio	70 dB
Dynamic range	55 dB

Speakers	
Type	1 Way 1 Speaker
Impedance	6 Ω
Rated Input Power	20 W
Max. Input Power	40 W
Net Dimensions (WxHxD)	136 mm x 180 mm x 210 mm
Net Weight (1EA)	1.3 kg

- Design and specifications are subject to change without notice.

# Maintenance

## Handling the Unit

### When shipping the unit

Please save the original shipping carton and packing materials. If you need to ship the unit, for maximum protection, re-pack the unit as it was originally packed at the factory.

### Keeping the exterior surfaces clean

Do not use volatile liquids such as insecticide spray near the unit.

Wiping with strong pressure may damage the surface.

Do not leave rubber or plastic products in contact with the unit for a long period of time.

### Cleaning the unit

To clean the player, use a soft, dry cloth. If the surfaces are extremely dirty, use a soft cloth lightly moistened with a mild detergent solution. Do not use strong solvents such as alcohol, benzine, or thinner, as these might damage the surface of the unit.

### Maintaining the Unit

The unit is a high-tech, precision device. If the optical pick-up lens and disc drive parts are dirty or worn, the picture quality could be diminished. For details, please contact your nearest authorized service centre.

## Notes on Discs

### Handling Discs

Never stick paper or tape on the disc.

### Storing Discs

After playing, store the disc in its case. Do not expose the disc to direct sunlight or sources of heat and never leave it in a parked car exposed to direct sunlight.

### Cleaning Discs

Do not use strong solvents such as alcohol, benzene, thinner, commercially available cleaners, or anti-static spray intended for old vinyl records.

