



LG

Life's Good

OWNER'S MANUAL

LED TV*

* LG LED TV applies LCD screen with LED backlights.

Please read this manual carefully before operating the your TV and retain it for future reference.

29MA73D
29LN450W

WARNING: This product contains chemicals known to the State of California to cause cancer and birth defects or other reproductive harm. ***Wash hands after handling.***

TABLE OF CONTENTS

3 LICENSES

4 INSTALLATION PROCEDURE

5 ASSEMBLING AND PREPARING

- 5 Unpacking
- 7 Parts and buttons
- 9 Lifting and moving the TV
- 10 Setting up the TV
 - 10 - Attaching the Stand
 - 12 - Mounting on a table
 - 12 - Tidying cables
 - 14 - Detaching the Stand
 - 15 - Mounting on a wall

17 WATCHING TV

- 17 Turning the TV on for the first time
- 19 TV display (5:9 OSD)
 - 19 - Program Guide
- 20 PIP function

22 MAKING CONNECTIONS

- 22 Connecting an antenna
- 23 Connecting to a HD receiver, DVD Player, VCR or Gaming device
 - 23 - HDMI connection
 - 24 - DVI-D connection
 - 25 - Component connection
 - 26 - Composite Connection
- 27 Headphone connection
- 28 Connecting a USB Device
- 29 Smartphone (MHL) connection
- 30 Connecting to a PC
 - 31 - HDMI connection
 - 32 - DVI-D connection
 - 33 - Display Port connection

34 REMOTE CONTROL

36 INSTALLING SCREEN SPLIT

37 CUSTOMIZING SETTINGS

- 37 Accessing the Main Menus
 - 37 - TV, Component, AV
 - 43 - DVI, HDMI1, HDMI2/MHL, DisplayPort

50 USING THE USER GUIDE

- 50 Accessing the On-Screen User Guide

51 MAINTENANCE

- 51 Cleaning Your TV
 - 51 Screen and frame
 - 51 Cabinet and stand
 - 51 Power cord
- 52 Preventing "Image burn" or "Burn-in" on your TV screen

53 TROUBLESHOOTING

54 SPECIFICATIONS

LICENSES

Supported licenses may differ by model. For more information of the licenses, visit www.lg.com.



Manufactured under license from Dolby Laboratories. Dolby and the double-D symbol are trademarks of Dolby Laboratories.



The terms HDMI and HDMI High-Definition Multimedia Interface, and the HDMI logo are trademarks or registered trademarks of HDMI Licensing LLC in the United States and other countries.



ABOUT DIVX VIDEO: DivX® is a digital video format created by DivX, LLC, a subsidiary of Rovi Corporation. This is an official DivX Certified® device that plays DivX video. Visit divx.com for more information and software tools to convert your files into DivX videos.

ABOUT DIVX VIDEO-ON-DEMAND: This DivX Certified® device must be registered in order to play purchased DivX Video-on-Demand (VOD) movies. To obtain your registration code, locate the DivX VOD section in your device setup menu. Go to vod.divx.com for more information on how to complete your registration.

DivX Certified® to play DivX® video up to HD 1080p, including premium content.

DivX®, DivX Certified® and associated logos are trademarks of Rovi Corporation or its subsidiaries and are used under license.

Covered by one or more of the following U.S. patents: 7,295,673; 7,460,668; 7,515,710; 7,519,274



VESA, VESA logo, Display Port Compliance Logo and Display Port Compliance Logo for dual-mode source are all registered trademarks of the Video Electronics Standards Association.

INSTALLATION PROCEDURE

- 1 Open the package and make sure all the accessories are included.
- 2 Attach the stand to the TV.
- 3 Connect an external device to the TV.



NOTE

- Image shown may differ from your TV.
- Your TV's OSD (On Screen Display) may differ slightly from that shown in this manual.
- The available menus and options may differ from the input source or product model that you are using.
- New features may be added to this TV in the future.

ASSEMBLING AND PREPARING

Unpacking

Check your product box for the following items. If there are any missing accessories, contact the local dealer where you purchased your product. The illustrations in this manual may differ from the actual product and accessories.

! NOTE

- The accessories supplied with your product may vary depending on the model.
- Product specifications or contents in this manual may be changed without prior notice due to upgrade of product functions.

! CAUTION

- Do not use any pirated items to ensure the safety and product life span.
- Any damages or injuries by using unapproved or counterfeit parts or accessories are not covered by the warranty.

! NOTE

- The items supplied with your product may vary depending on the model.
- Product specifications or contents of this manual may be changed without prior notice due to upgrade of product functions.
- For an optimal connection, HDMI cables and USB devices should have bezels less than 10 mm thick and 18 mm width. Use an extension cable that supports USB 2.0 if the USB cable or USB memory stick does not fit into your TV's USB port.

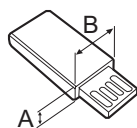
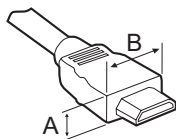

*A ≦ 10 mm

*B ≦ 18 mm

29MA73D 29LN450W

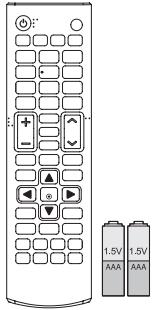

**Remote Control
Batteries (AAA)**

(See p.34, See p.35)



**CD (Owner's Manual)
Cards**

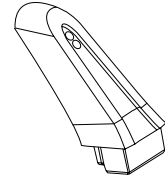

Stand Body

(See p.10, See p.14)

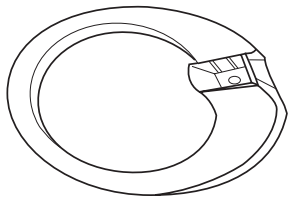

Stand Base

(See p.10, See p.14)



Screw 2 ea

(See p.10, See p.14)

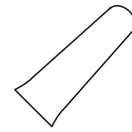

Stand Screw cover

(See p.10, See p.14)

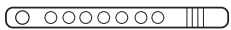

Cable Tie

(See p.12)

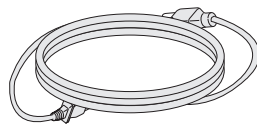

Power Cord

(See p.12)

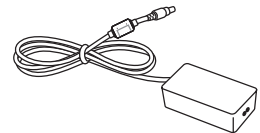

AC-DC Adapter

(See p.12)

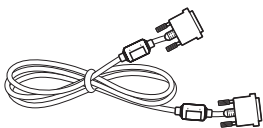

DVI-D cable

(See p.24, See p.32)

Parts and buttons

29MA73D

29LN450W

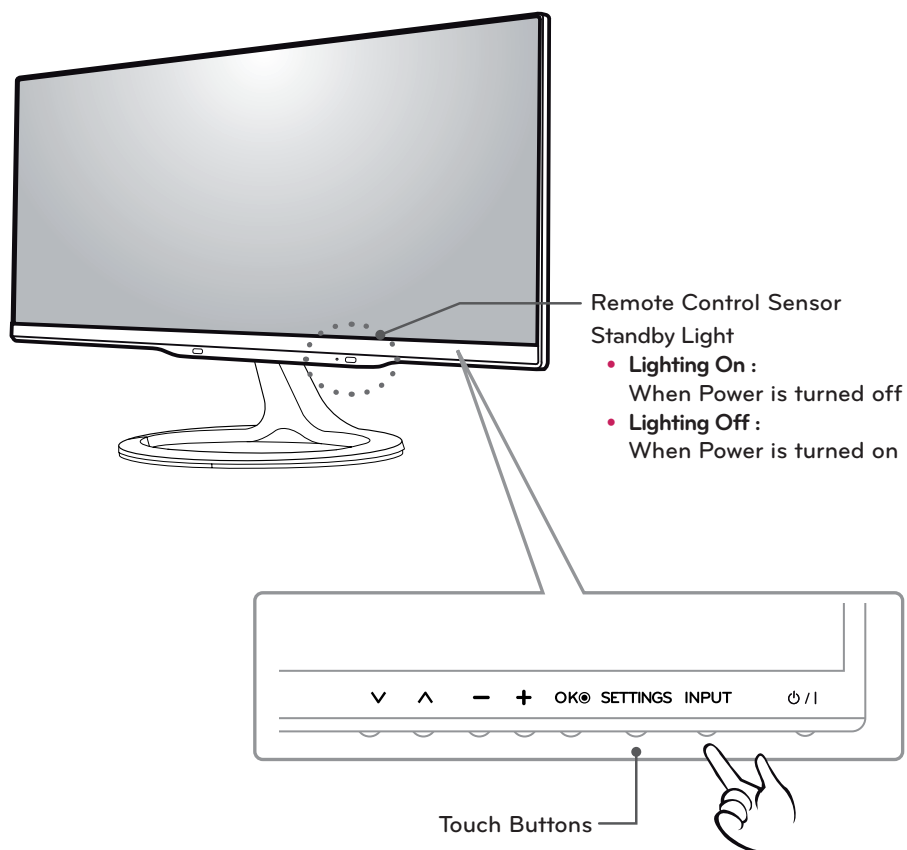

NOTE

All of the buttons are touch sensitive and can be operated through simple touch with your finger.
Power and control touch button are located on the bottom.

Touch button	Description
∨ ∧	Scrolls through the saved programmes.
- +	Adjusts the volume level.
OK	Selects the highlighted menu option or confirms an input.
SETTINGS	Accesses the main menus, or saves your input and exits the menus.
INPUT	Changes the input source.
⏻ / I	Turns the power on or off.

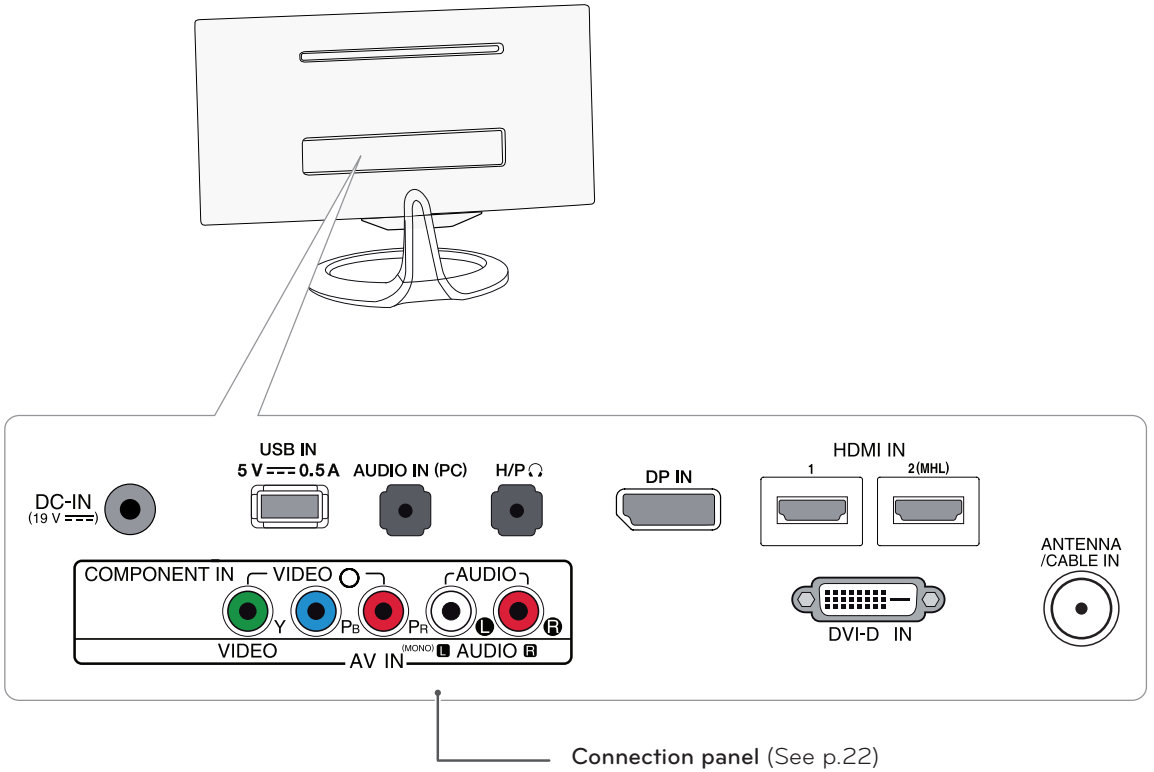

Lifting and moving the TV

When moving or lifting the TV, read the following to prevent the TV from being scratched or damaged and for safe transportation regardless of its type and size.



CAUTION

Avoid touching the screen at all times, as this may result in damage to the screen or some of the pixels used to create images.

- It is recommended to move the TV in the box or packing material that the TV originally came in.
- Before moving or lifting the TV, disconnect the power cord and all cables.
- Hold the top and bottom of the TV frame firmly. Make sure not to hold the transparent part, speaker, or speaker grill area.

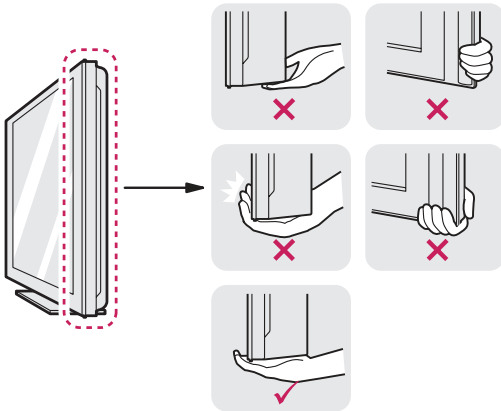

- When holding the TV, the screen should face away from you to prevent the screen from scratches.

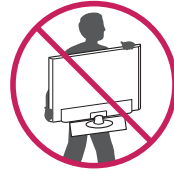

- When transporting the TV, do not expose the TV to jolts or excessive vibration.
- When transporting the TV, keep the TV upright, never turn the TV on its side, or tilt towards the left or right.



CAUTION

29MA73

29LN450



Setting up the TV

Attaching the Stand

- 1 Place the screen face down.



CAUTION

- To protect the screen from scratches, cover the surface with a soft cloth.

- 2 Check the orientation (front and rear) of the stand base and mount the **Stand Body** to the **stand hinge** as shown in the figure.

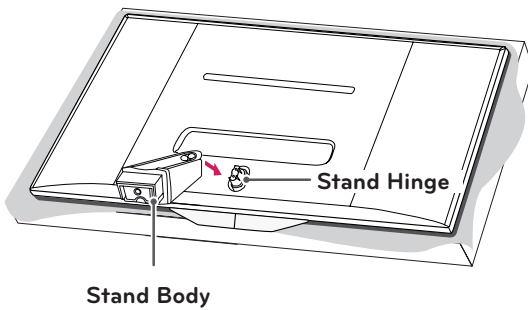

- 3 Fix two screws into the back of the stand base and close the screw cover.

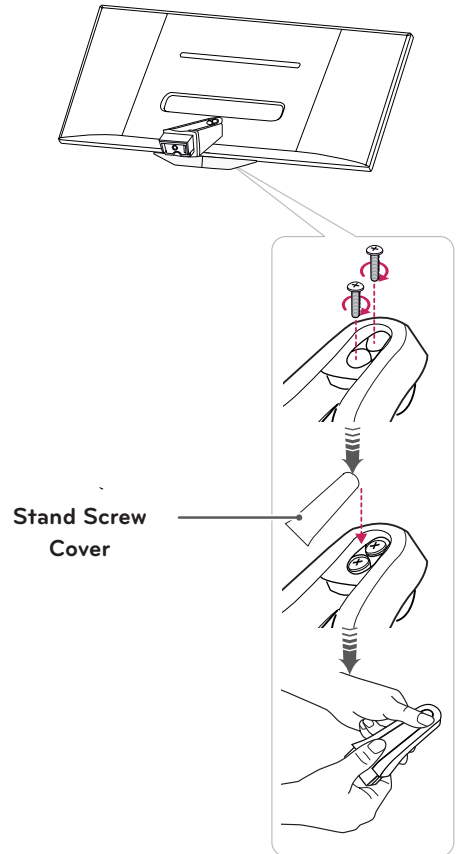

- 4 Attach the **Stand Base** from the **Stand Body** by turning the screw to the right with a **Coin**.

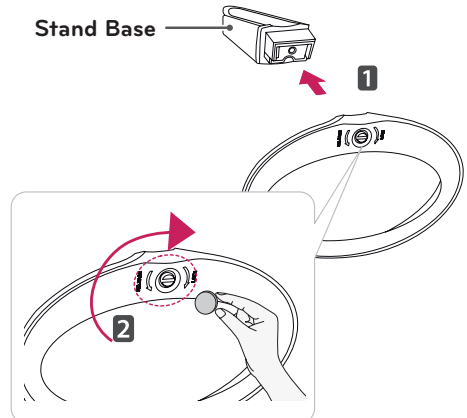

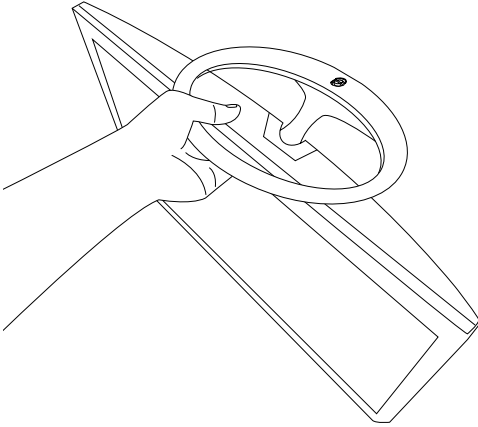
**CAUTION**

- Do not carry the monitor upside-down as this may cause it to fall off its stand, resulting in damage or injury.
- The illustration shows a general example of installation and may look different from the actual product.

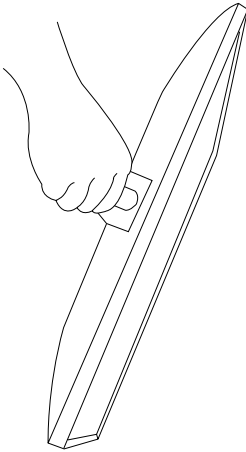

- Do not carry the monitor upside-down by holding the stand body as this may cause it to fall off, resulting in damage or injury.
- The illustration shows a general example of installation and may look different from the actual product.

Mounting on a table

- 1 Lift and tilt the TV into its upright position on a table.

Leave a 10 cm (4 inches) (minimum) space from the wall for proper ventilation.

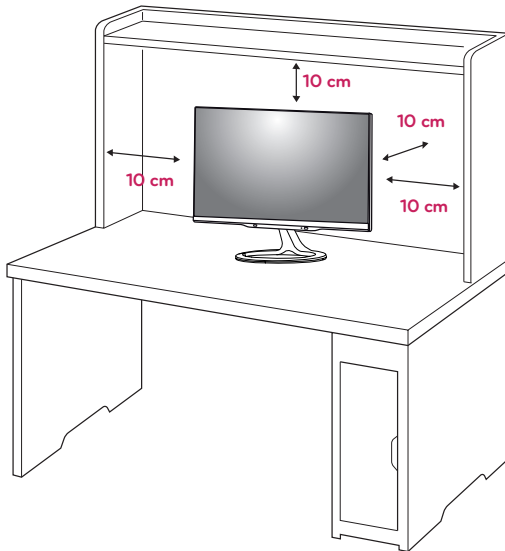

- 2 Connect the **AC-DC Adapter** and **Power Cord** to a wall outlet.

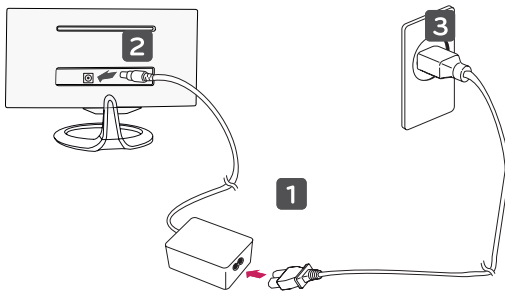

CAUTION

Do not place the TV near or on sources of heat, as this may result in fire or other damage.



CAUTION

Disconnect the power cord first, and then move or install the TV. Otherwise electric shock may occur.

Tidying cables

Gather and bind the cables with the supplied cable tie.

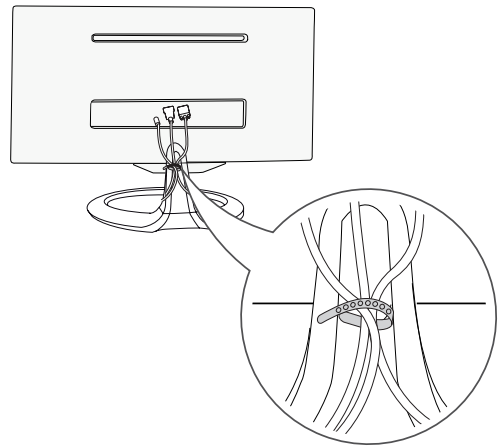

NOTE

Tilt from -5 to $+20$ degrees up or down to adjust the angle of the TV to suit your view.

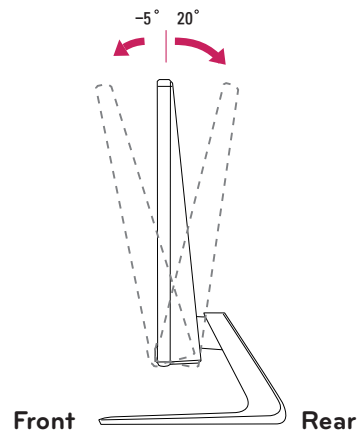

! WARNING

- When you adjust the angle, do not hold the bottom of the TV frame as shown on the following illustration, as may injure your fingers.

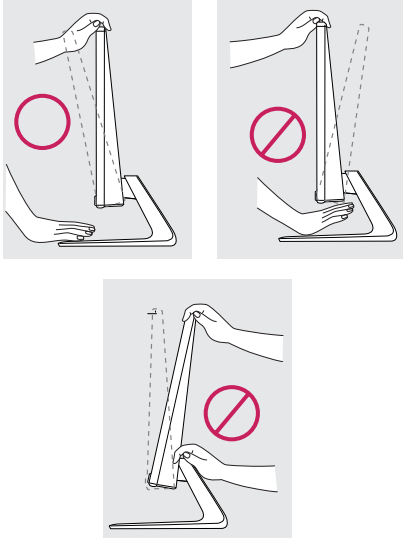

- Be careful not to touch or press the screen area when adjusting the angle of the TV.

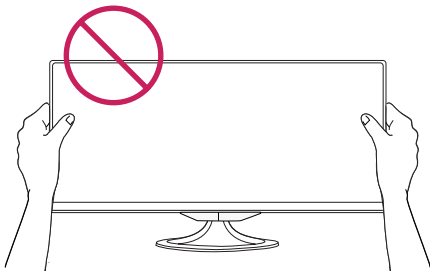

- Be careful not to press the screen with your fingers or palm.

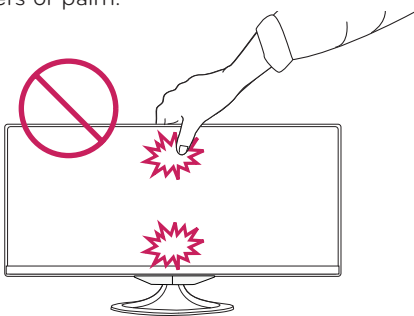
**Using the Kensington security system**

The Kensington security system connector is located at the back of the TV. For more information of installation and using, refer to the manual supplied with the Kensington security system or visit <http://www.kensington.com>.

Connect the Kensington security system cable between the TV and a table.

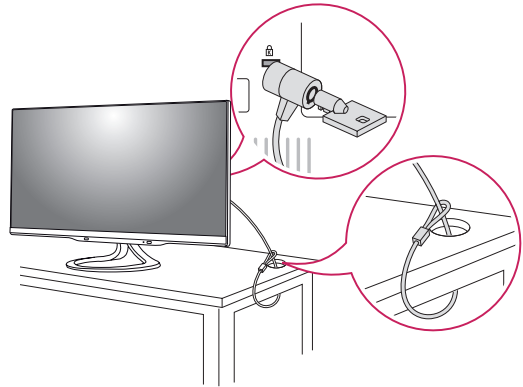
**! NOTE**

The Kensington security system is optional. You can obtain additional accessories from most electronics stores.

Detaching the Stand

- 1 Place the screen face down.



CAUTION

- To protect the screen from scratches, cover the surface with a soft cloth.

- 2 Turn the screw to the left, and then pull out the **Stand Base** from the **Stand Body**.

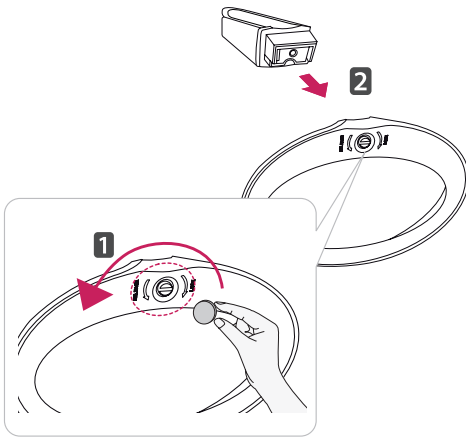

- 3 Open the screw cover on the back of the stand body and use a screw driver to remove the two screws.

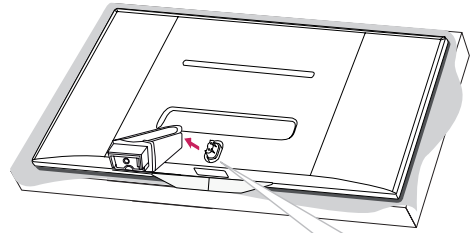

Stand Screw Cover

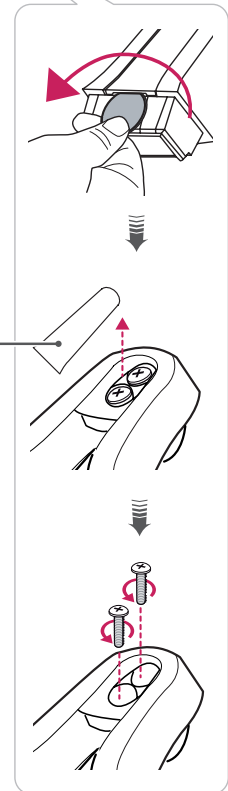

Mounting on a wall

For proper ventilation, allow a clearance of 10 cm on each side and from the wall. Detailed installation instructions are available from your dealer, see the optional Tilt Wall Mounting Bracket Installation and Setup Guide.

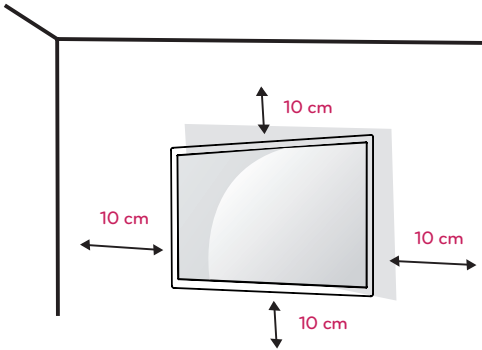

- 5 Please use VESA standard as below.
 - 784.8 mm (30.9 inch) and under
 - * Wall Mount Pad Thickness : 2.6 mm
 - * Screw : \varnothing 4.0 mm x Pitch 0.7 mm x Length 10 mm
 - 787.4 mm (31.0 inch) and above
 - * Please use VESA standard wall mount pad and screws.

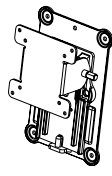
VESA (A x B)	100 x 100
Standard screw	M4
Number of screws	4
Wall mount bracket (optional)	RW120 

If you intend to mount the TV to a wall, attach Wall mounting interface (optional parts) to the back of the TV.

When you install the TV using the wall mounting interface (optional parts), attach it carefully so it will not drop.

- 1 Please, Use the screw and wall mount interface in accordance with VESA Standards.
- 2 If you use screw longer than standard, the TV might be damaged internally.
- 3 If you use improper screw, the product might be damaged and drop from mounted position. In this case, LG Electronics is not responsible for it.
- 4 VESA compatible only with respect to screw mounting interface dimensions and mounting screw specifications.

- VESA (A x B)

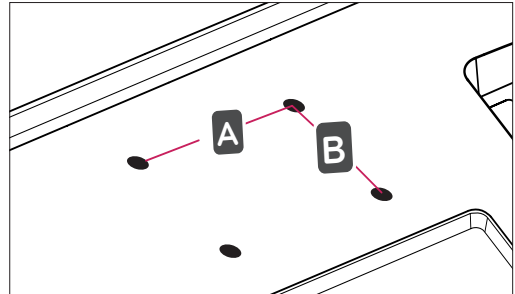

**CAUTION**

- Disconnect the power cord first, and then move or install the TV. Otherwise electric shock may occur.
- If you install the TV on a ceiling or slanted wall, it may fall and result in severe injury.
- Use an authorized LG wall mount and contact the local dealer or qualified personnel.
- Do not over tighten the screws as this may cause damage to the TV and void your warranty.
- Use the screws and wall mounts that meet the VESA standard. Any damages or injuries by misuse or using an improper accessory are not covered by the warranty.

**NOTE**

- Use the screws that are listed on the VESA standard screw specifications.
- The wall mount kit includes an installation manual and necessary parts.
- The wall mount bracket is optional. You can obtain additional accessories from your local dealer.
- The length of screws may differ depending on the wall mount. Be sure to use the proper length.
- For more information, refer to the instructions supplied with the wall mount.

WATCHING TV

Turning the TV on for the first time

When you access the TV for the first time, the initial setting screen appears. Select a language and customize the basic settings.

- 1 Connect the power cord to a power outlet.
- 2 Press  on the TV or power button on the remote control to turn the TV on.
The Standby Light is turned off.



NOTE

When the TV is in Power saving mode, the Standby Light turns amber.

- 3 The initial setting screen appears if you access the TV for the first time.



NOTE

If you do not operate the TV within 40 seconds when the setting menu screen appears, the setting menus will disappear.

- 4 Follow the on-screen instructions to customize your TV according to your preferences.

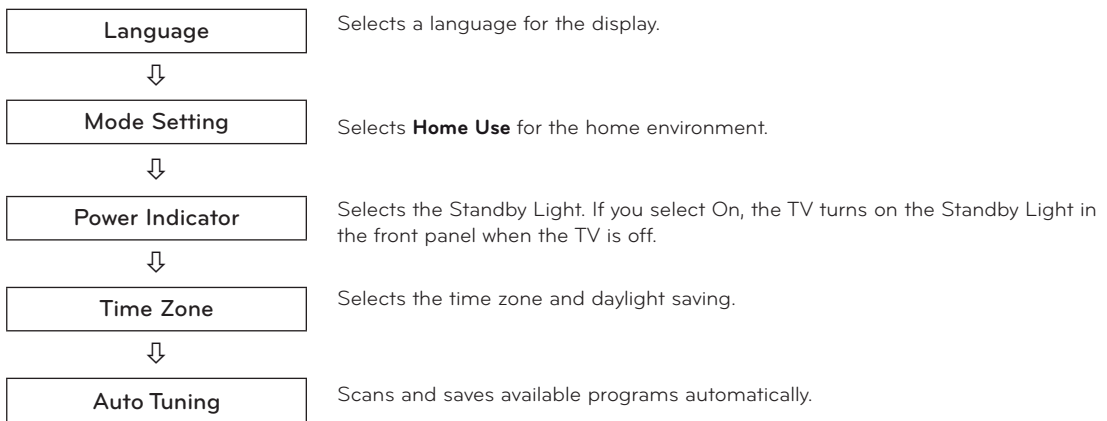

**NOTE**

- For those countries without confirmed DTV broadcasting standards, some DTV features might not work, depending on the DTV broadcasting environment.
- To display images in the best quality for your home environment, select **Home Use mode**.
- **Store Demo** mode is suitable for the retail environment.
- If you select **Store Demo mode**, the previously customized settings will switch to the default settings of **Store Demo mode** in 5 minutes.

5 When the basic settings are complete, press **OK**.

**NOTE**

If you do not complete the initial setting, it will appear whenever you access the TV.

6 To turn the TV off, press **⏻/I** on the TV.
The Standby Light is turned on.

**CAUTION**

Disconnect the power cord from the power outlet when you do not use the TV for a long period of time.

**NOTE**

- You can also switch the TV from PC mode to TV mode, press **TV/PC**.
- You can also access **Initial Setting** by accessing **OPTION** in the main menus.

TV display (5:9 OSD)

Program Guide

Press the **INFO** button on the remote control while you are watching TV.

- On the right-hand side (5:9 OSD) of the TV screen, the details of channel you are currently watching and the channel organization information are displayed.
- For analogue TV, the message "No program information available" is displayed.
- Only digital TV channels are searched and displayed. If there is no channel available, the message "No program information available" is displayed.

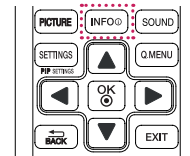

NO.	Description
①	Displays the channel you are currently watching.
②	Displays the broadcasting type of the channel you are currently watching.
③	Displays the broadcasting type icon. (e.g., HD, Dolly, Digital, etc.)
④	Displays the current date and time.
⑤	Displays the current channel or the entire channel list.
⑥	Broadcasting type icon area
⑦	Displays the name of program you are currently watching.
⑧	Displays the running time of the program. - Displays the progress including start and end times of the program.
⑨	Displays the available functions. - If the channel you are currently watching is focused, the Watch function is displayed. - If the channel you are not currently watching is focused, the Schedule function is displayed.

PIP function

Press the **PIP** button on the remote control while you are watching DVI, HDMI1,2, DisplayPort

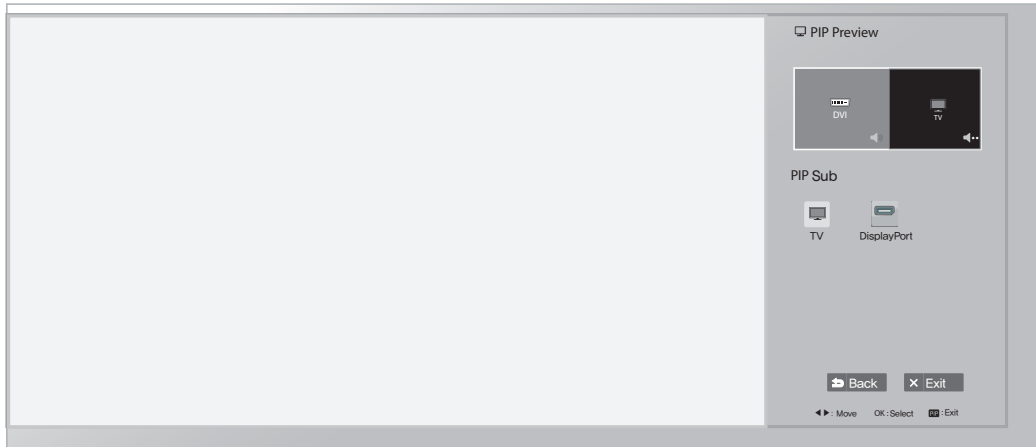
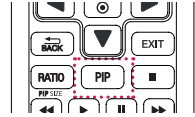

While watching PIP, press the PIP Settings button on the remote control to display the Sub Menu.

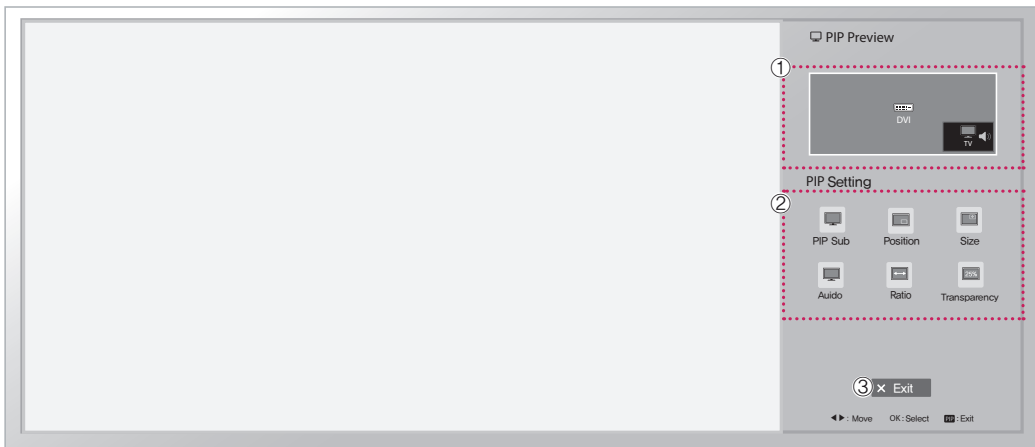

NO.	Description						
①	Displays the configured OSD icon and its name.						
②	Selects an option for PIP Sub. (See the PIP Map below.)						
Input	PIP Map		PIP Sub				
			DVI	HDMI1	HDMI2/ MHL	DisplayPort	TV
	current	DVI	X	X	X	O	O
	input	HDMI1	X	X	X	O	O
		HDMI2/ MHL	X	X	X	O	O
		DisplayPort	O	O	O	X	O
	TV	X	X	X	X	X	
Position	Sets the position of the PIP Sub window. (top left, top right, bottom left or bottom right corner) *This function is disabled when size is set to [Balanced].						
Size	Sets the size of the PIP Sub window. (Small / Medium / Large / Balanced)						
Audio	Selects the audio input. *Only the items that are available under the current combination are enabled (PIP Main/PIP Sub or Audio in).						
Ratio	Sets the aspect ratio of PIP Sub. *This function is disabled when Size is set to [Balanced].						
Transparency	Sets the opacity of PIP. (OFF/25%/50%/75%) *This function is disabled when Size is set to [Balanced].						
③	Exit button - Exits the OSD menu.						

MAKING CONNECTIONS

29MA73D **29LN450W**

Connect various external devices to the TV and switch input modes to select an external device. For more information about an external device's connection, refer to the manual supplied with each device.

Available external devices are: HD receivers, DVD players, VCRs, audio systems, USB storage devices, PC, camcorders or cameras, gaming devices, and other external devices.

NOTE

- If you record a TV program on a DVD recorder or VCR, make sure to connect the TV signal input cable to the TV through a DVD recorder or VCR. For more information about recording, refer to the manual supplied with the connected device.
- The external device connection may differ from the model.
- Connect external devices to the TV regardless of the order of the TV port.

Connecting an antenna

Connect an antenna, cable or cable box to watch TV referring to the following. The illustrations may differ from the actual accessories and an RF cable is optional.

Connect the TV to a wall antenna socket with an RF cable (75 Ω).

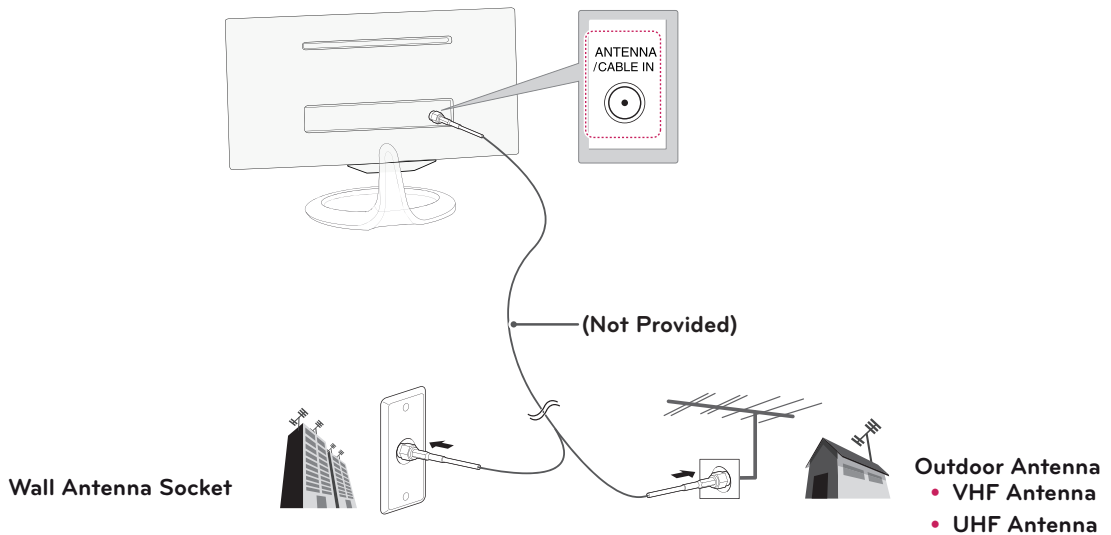

NOTE

- Use a signal splitter to use more than 2 TVs.
- If the image quality is poor, install a signal amplifier properly to improve the image quality.
- If the image quality is poor with an antenna connected, aim the antenna to the proper direction.
- Visit <http://AntennaWeb.org> for more information about the antenna and cable connection.

CAUTION

- Make sure not to bend the copper wire of the RF cable.

Copper wire

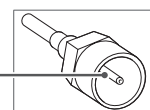

- Complete all connections instructions between devices, and then connect the power cord to the power outlet to prevent damages to your TV.

Connecting to a HD receiver, DVD Player, VCR or Gaming device

Connect a HD receiver, DVD Player, VCR or Gaming device to the TV and select an appropriate input mode.

HDMI connection

HDMI is the best way to connect a device.

Transmits the digital video and audio signals from an external device to the TV. Connect the external device and the TV with the HDMI cable as shown on the following illustration.

! NOTE

- HDMI cable to the HDMI input and a digital broadcast receiver, connect the HDMI output. Video, with sound output.
- Press the INPUT button on the remote control to select either HDMI1 or HDMI2/MHL.
- Dolby Digital and DTS are not supported. If no sound is coming out, set the audio output of the connected device to PCM.

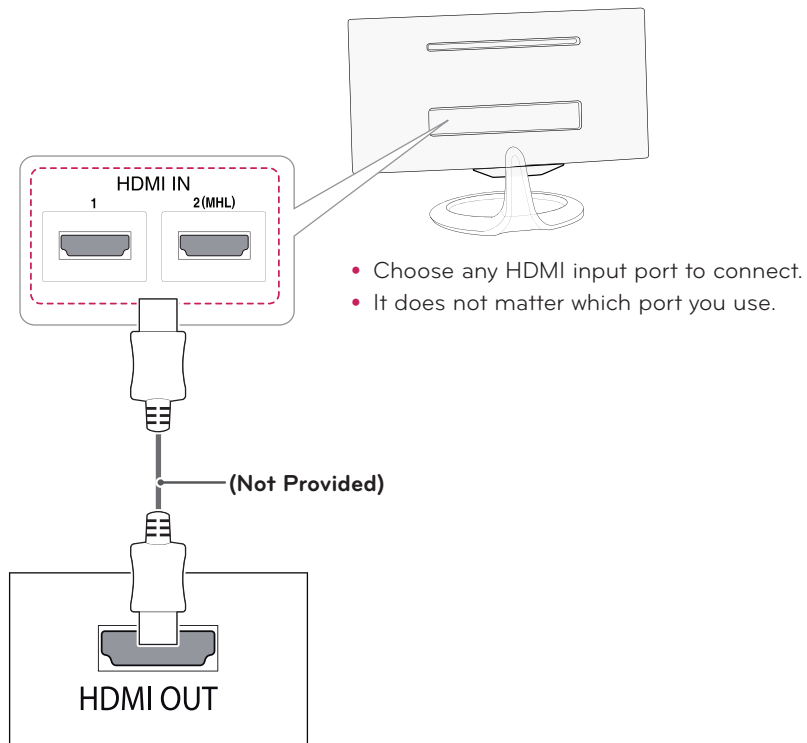

DVD / Blu-Ray / HD Cable Box /
HD STB / Gaming device

DVI-D connection

Transmits the digital video signal from an external device to the TV. Connect the external device and the TV with an DVI-D dual cable as shown in the following illustration. To transmit an audio signal, connect an optional audio cable.

NOTE

- Please use the DVI-D dual cable provided.
- If you do not use DVI-D dual cable, this may result in distortion on the screen.
- If you do not use an optional external speaker, connect the external device to the TV with an optional audio cable.
- Connect the signal input cable and tighten it by turning the screws clockwise.
- Press the INPUT button on the remote control to select DVI.

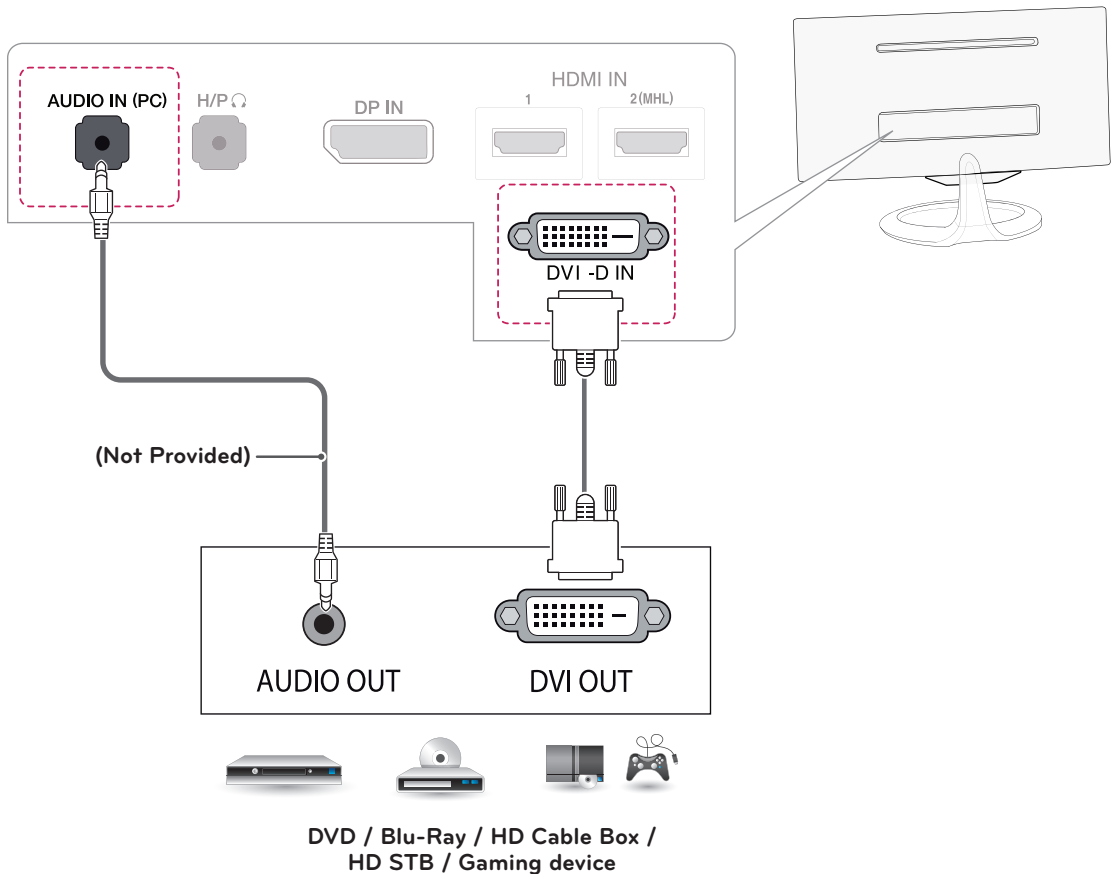
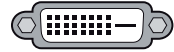

Component connection

Transmits the analog video and audio signals from an external device to the TV. Connect the external device and the TV with the component cable as shown on the following illustration. To display images by using progressive scan, make sure to use a component cable.

NOTE

- If cables are installed incorrectly, it could cause the image to display in black and white or with distorted color.
- **Check to ensure each cable is matched with the corresponding color connection.**
- Press the INPUT button on the remote control to select Component.

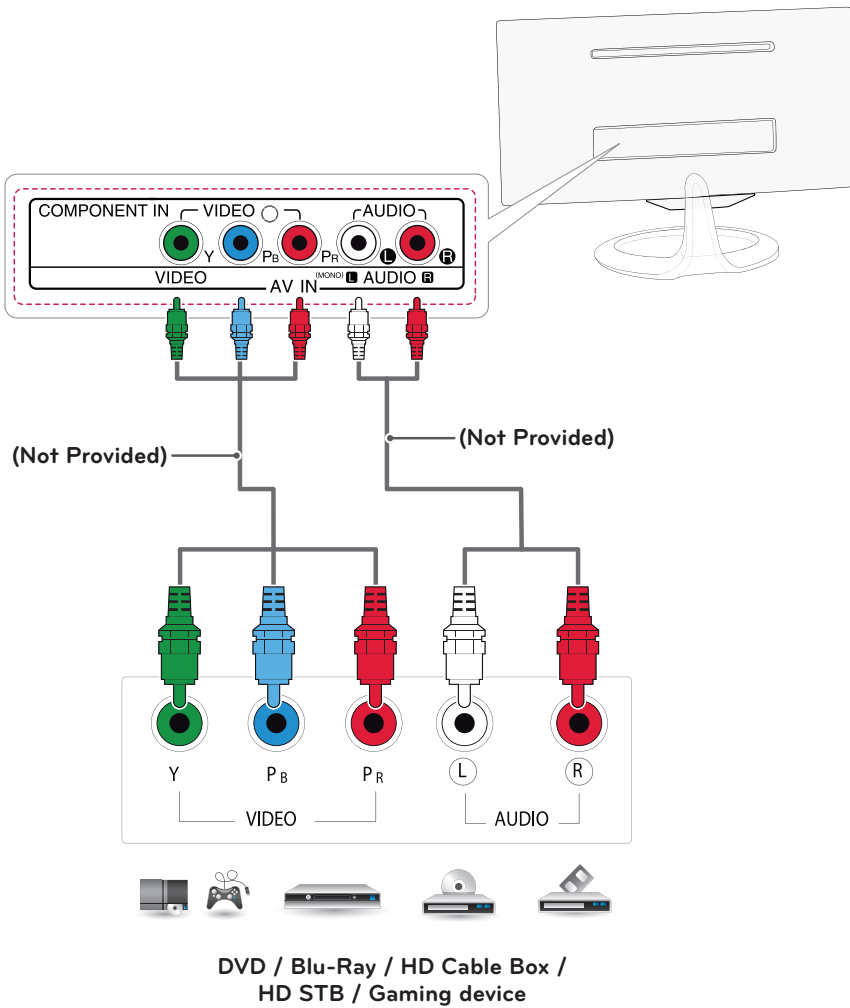

Composite Connection

Transmits the analog video and audio signals from an external device to the TV. Connect the external device and the TV with the composite cable as shown on the following illustration.

NOTE

- Check to ensure each cable is matched with the corresponding color connection.
- Press the INPUT button on the remote control to select AV.

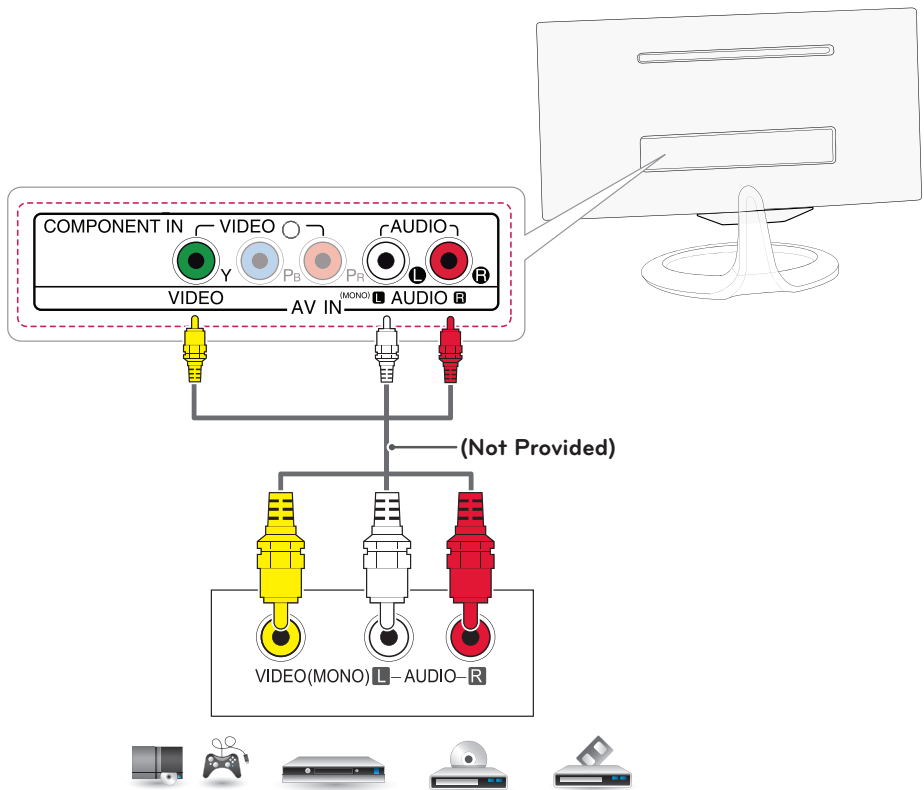

DVD / Blu-Ray / HD Cable Box /
HD STB / Gaming device

Headphone connection

Transmits the headphone signal from the TV to an external device. Connect the TV with the headphone as shown on the following illustration.

! NOTE

- AUDIO menu items are disabled when connecting a headphone.
- Headphone impedance: 16 Ω
- Max audio output of headphone: 2.5 mW to 5.5 mW
- Headphone jack size: 0.35 cm

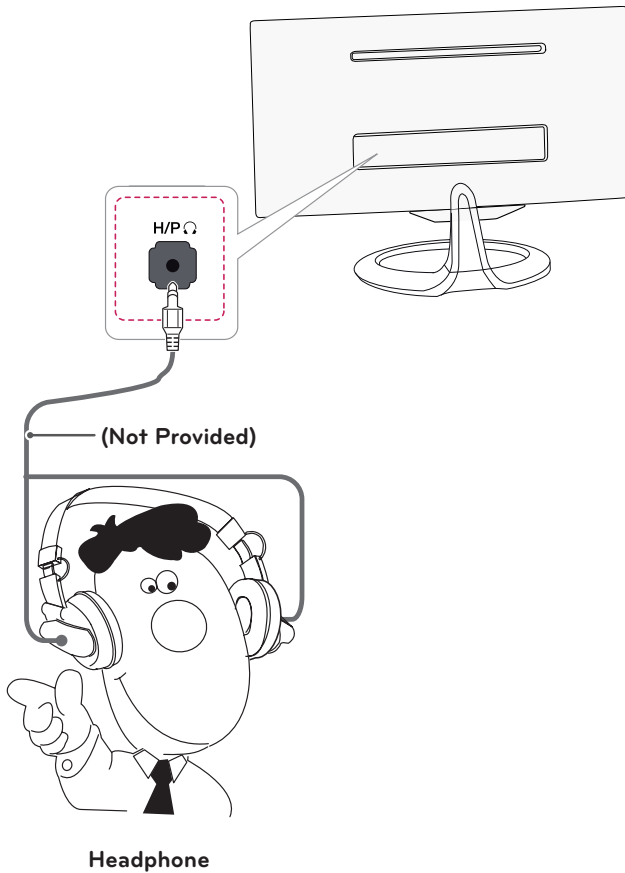

Connecting a USB Device

Connect a USB storage device such as a USB flash memory, external hard drive, MP3 player or a USB memory card reader to the TV and access the MY MEDIA to use various multimedia files.

! **NOTE**

- It may not work when USB 3.0 devices are connected.

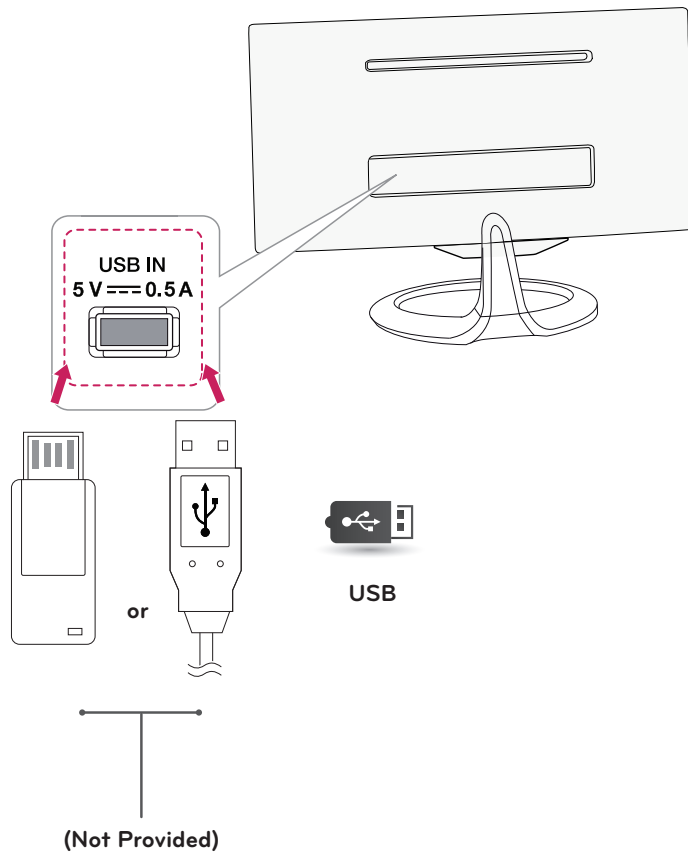

Smartphone (MHL) connection

Mobile High-definition Link (MHL) is an interface that allows you to play video and audio from your smartphone on the monitor by connecting the monitor to your smartphone. Connect the smartphone to the HDMI2/MHL port of the monitor using the supplied MHL signal cable and switch the input by pressing the input button on the monitor.

! NOTE

- This function only works for smartphones that support MHL.
 - There may be compatibility issues with other mobile phones.
- Use of the MHL remote control is not supported during the PIP operation.

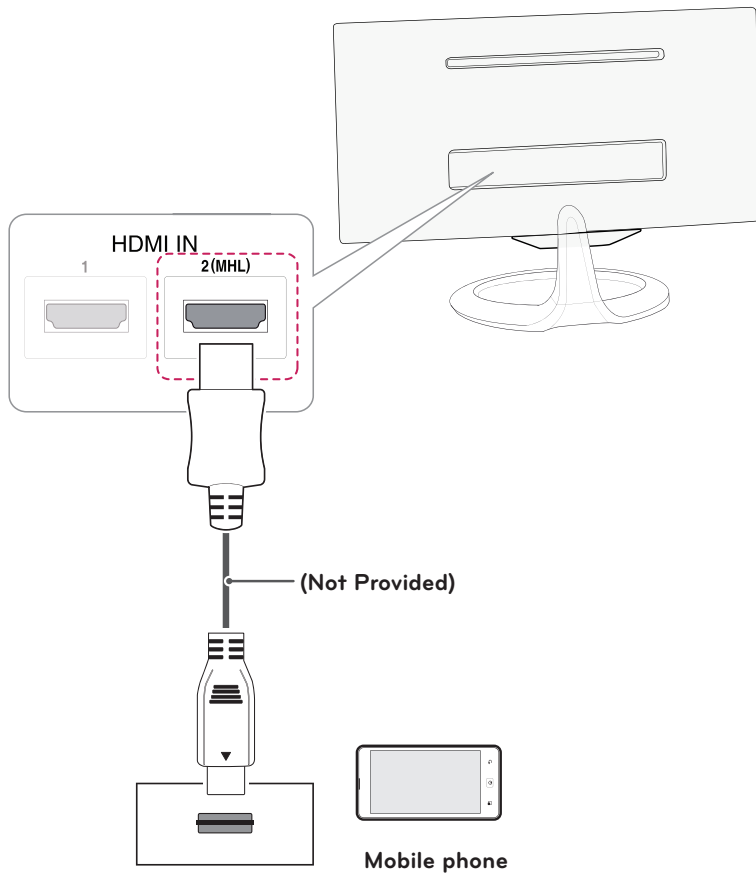

Connecting to a PC

Your TV supports the Plug & Play* feature.

* Plug & Play: The function when a PC recognizes a connected device and requires no driver to be installed.



NOTE

- It is recommended to use an TV with the HDMI connection for the best image quality.
- If you do not use an optional external speaker, connect the PC to the TV with the optional audio cable.
- If you turn the TV on when the set is cold, the screen may flicker. This is normal.
- Some red, green, or blue spots may appear on the screen. This is normal.
- Connect the signal input cable and tighten it by turning the screws clockwise.
- Do not press the screen with your finger for a long time as this may result in temporary distortion on the screen.
- Avoid displaying a fixed image on the screen for a long period of time to prevent image burn. Use a screensaver if possible.
- When connecting the power cord to the outlet, use a grounded (3-hole) multi-socket or a grounded power outlet.
- To comply with the standard specifications of the product, make sure to use a shielded interface cable made with a ferrite core for DVI-D and DVI-to-HDMI cables.

HDMI connection

Transmits the digital video and audio signals from your PC to the TV. Connect the PC and the TV with an HDMI cable as shown in the following illustrations.

! NOTE

- Use a High Speed HDMI™ cable.
- Please check your PC settings if you cannot hear any sound in HDMI mode.
- Press the INPUT button on the remote control to select either HDMI1 or HDMI2/MHL.
- Using a DVI to HDMI cable may cause compatibility issues.
- HDMI PC may cause device compatibility issues.
- Dolby Digital and DTS are not supported. If no sound is coming out, set the audio output of the connected device to PCM.

USING A NON-STANDARD HDMI CABLE MAY CAUSE A PROBLEM WITH SOME OF THE FUNCTIONS.
It is highly recommended to use a standard cable.

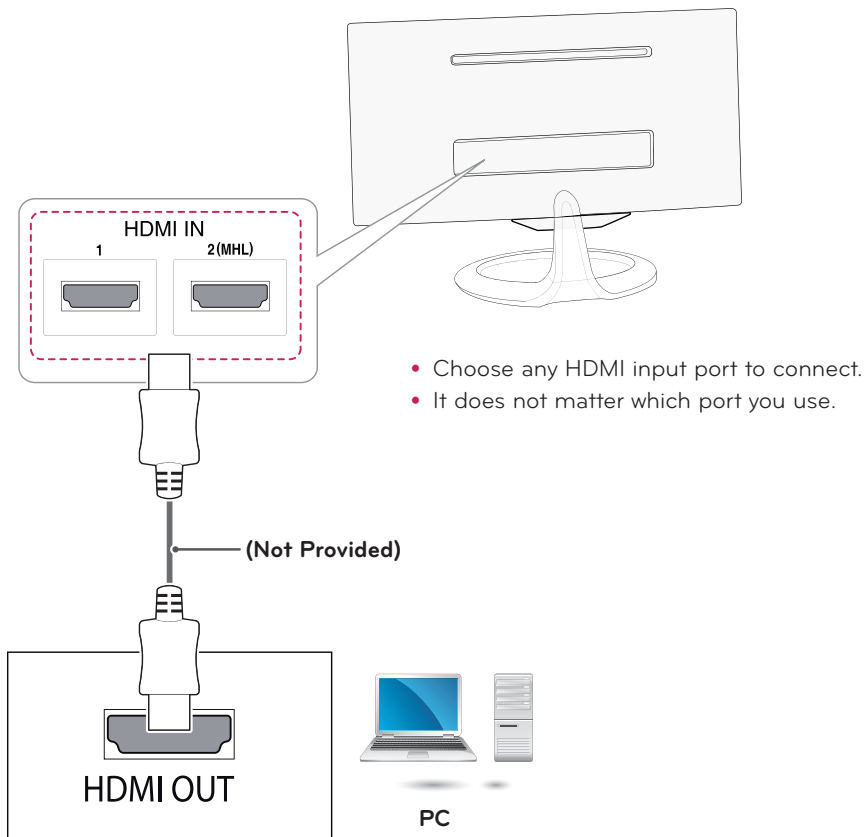

DVI-D connection

Transmits the digital video signal from your PC to the TV. Connect the PC and an TV with an DVI-D dual cable as shown the following illustrations. To transmit an audio signal, connect an optional audio cable.

NOTE

- Please use the DVI-D dual cable provided.
- If you do not use DVI-D dual cable, this may result in distortion on the screen.
- If you do not use an optional external speaker, connect the PC to the TV with the optional audio cable.
- Using a DVI to HDMI cable may cause compatibility issues.
- Connect the signal input cable and tighten it by turning the screws clockwise.
- Press the INPUT button on the remote control to select to DVI.

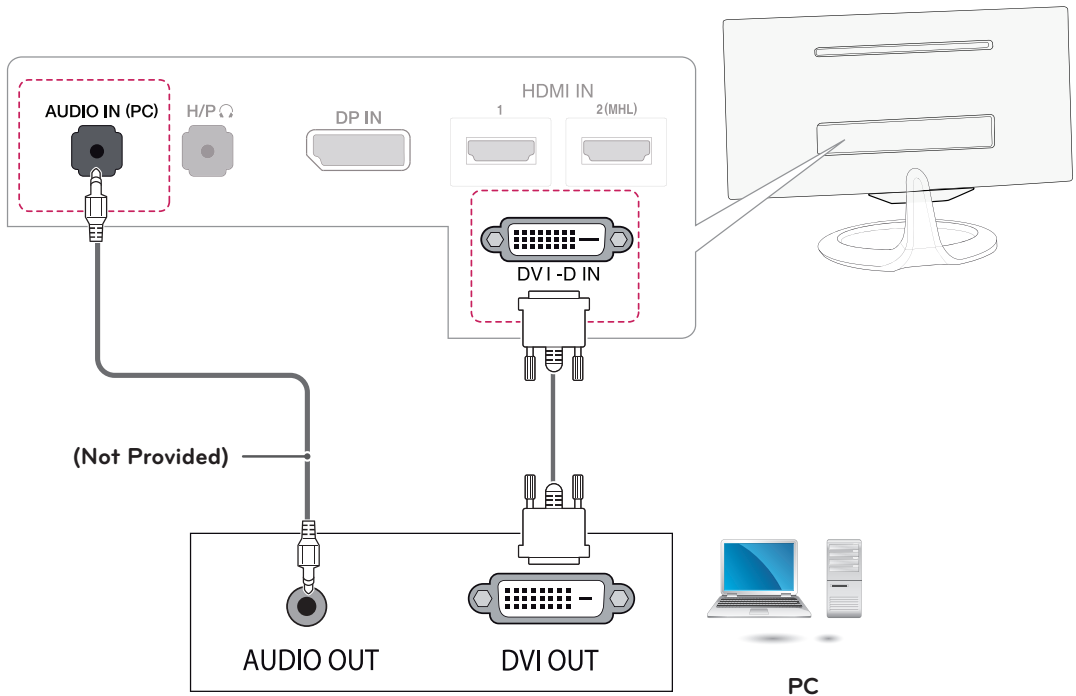
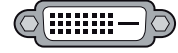

Display Port connection

Transmits the digital video and audio signals from your PC to the TV. Connect your PC to the TV using the display port cable as illustrated below.

! NOTE

- Sound may not hear depending on the DP version of your PC.
- Dolby Digital and DTS are not supported. If no sound is coming out, set the audio output of the connected device to PCM.
- Press the INPUT button on the remote control to select DisplayPort.
- Using a DP-to-HDMI or DP-to-DVI cable may cause compatibility issues.
- HDMI signals are not converted to DP signals.
- If you use a DP-to-HDMI cable, you can watch your media on a PC or other device with DP output by using the HDMI or DVI input port.

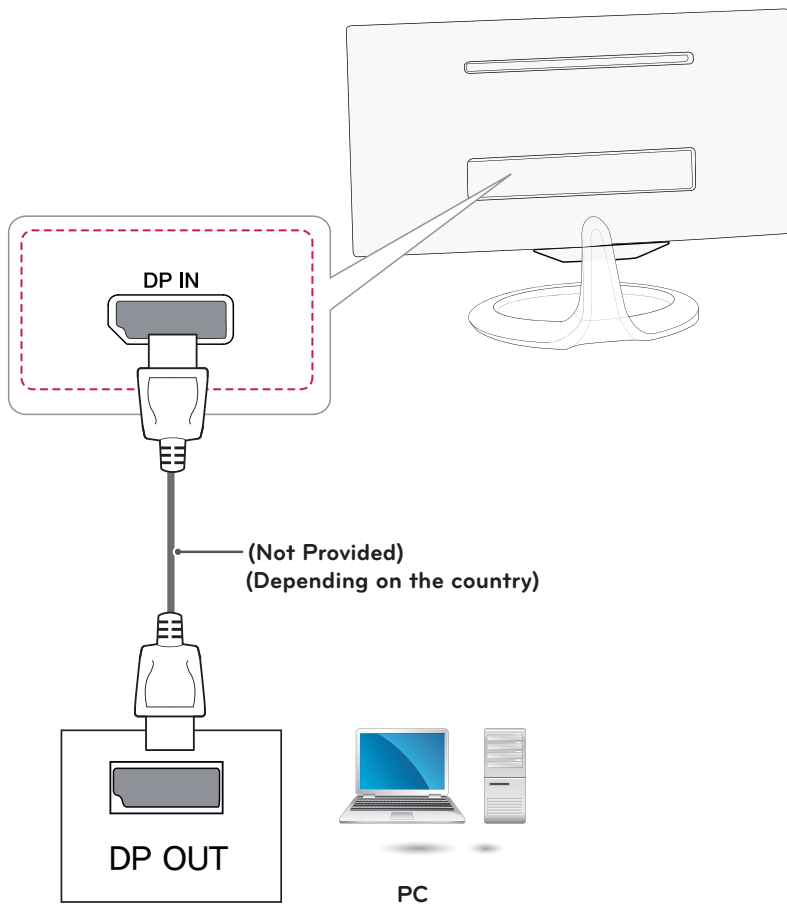

REMOTE CONTROL

The descriptions in this manual are based on the buttons of the remote control. Please read this manual carefully and use the TV correctly.

To replace batteries, open the battery cover, replace batteries (1.5 V AAA) matching ⊕ and ⊖ ends to the label inside the compartment, and close the battery cover.

To remove the batteries, perform the installation actions in reverse.

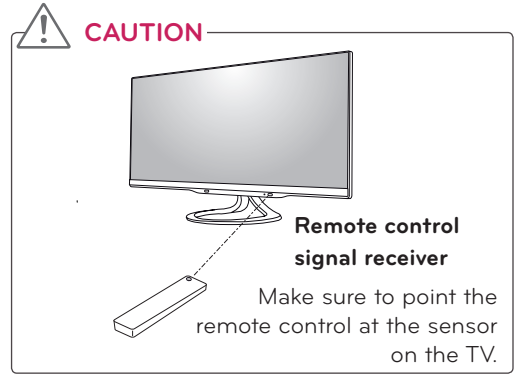
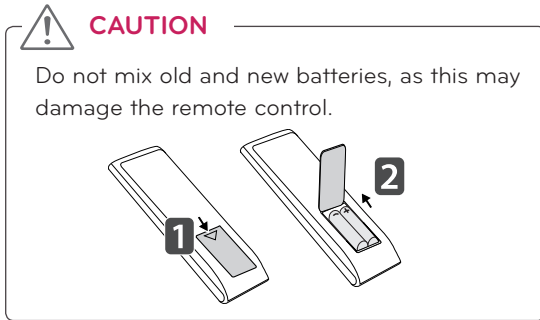

Make sure to point the remote control to the remote control sensor on the TV. Image shown may differ from your TV.

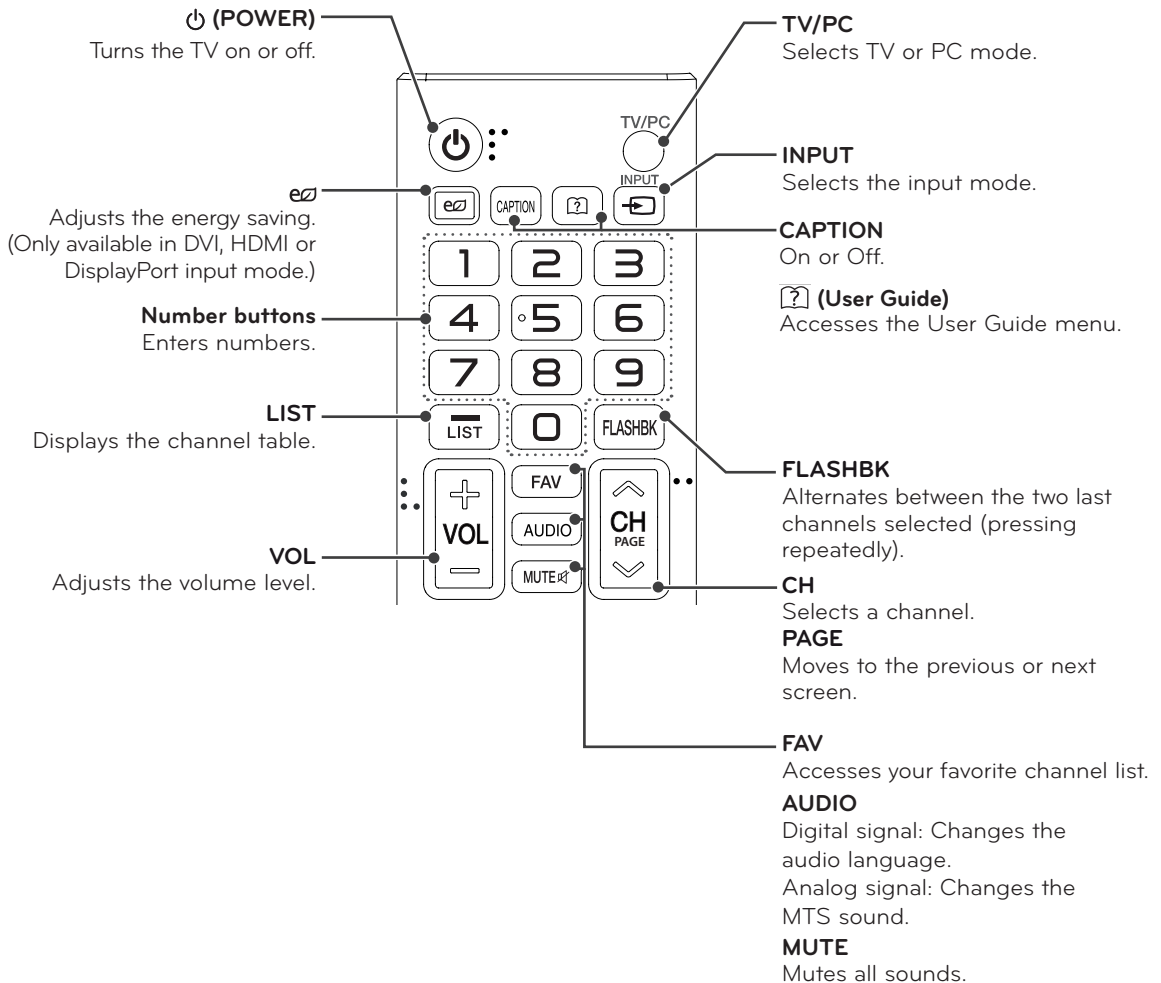

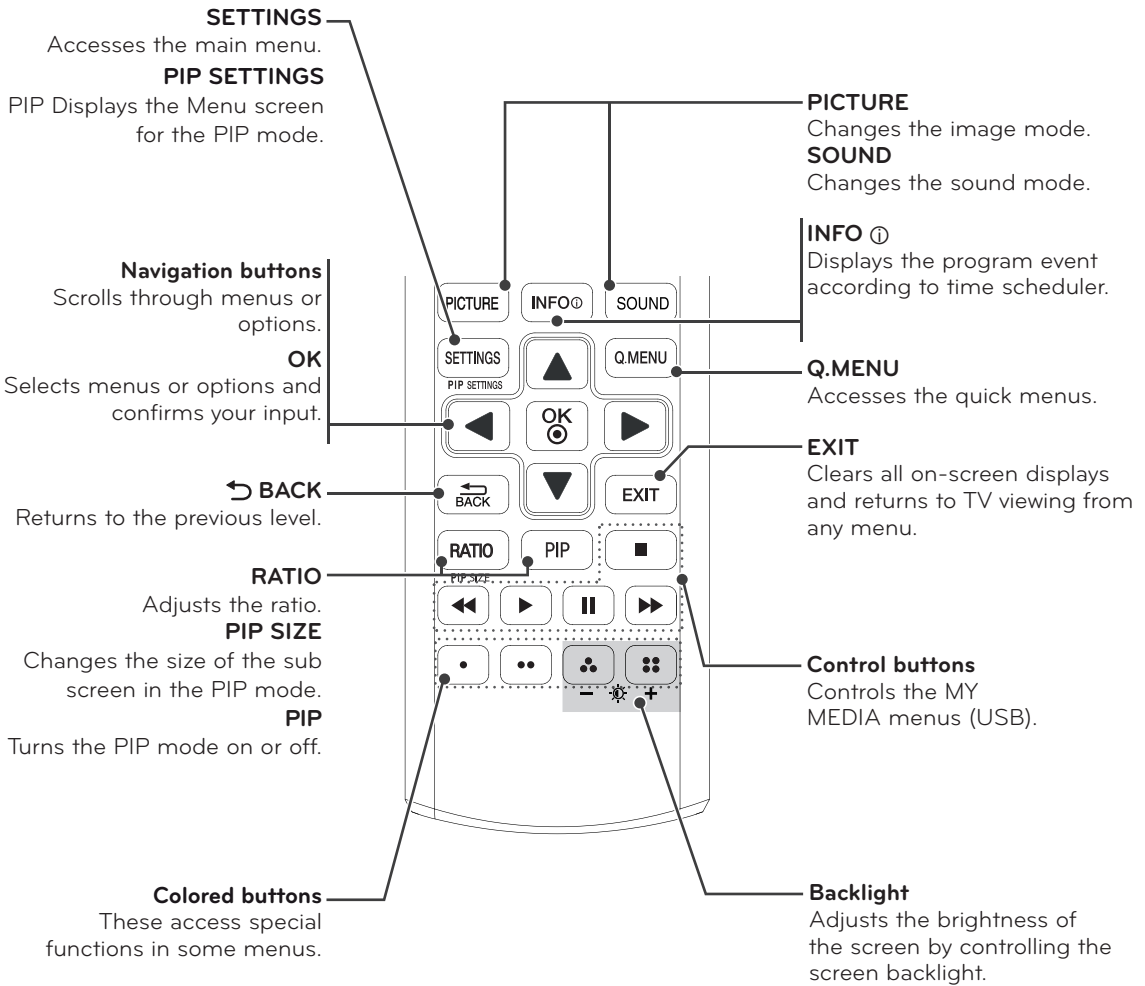

INSTALLING SCREEN SPLIT

Insert the the owner's manual CD included in the product package into your PC's CD driver and install the screen split.

- 1 Check "I accept the terms of the agreement" on the License Agreement screen and then click the [Next] button.

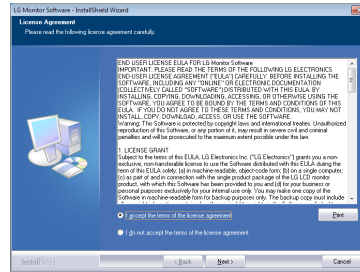

- 2 Select the program that you want to install.

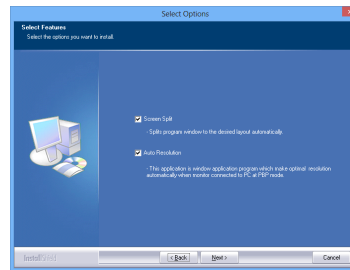

NOTE

If you run Screen Split, the Screen Split icon [] appears in the system tray at the right bottom of the PC screen.



Right-click the Screen Split icon and select a layout you want.

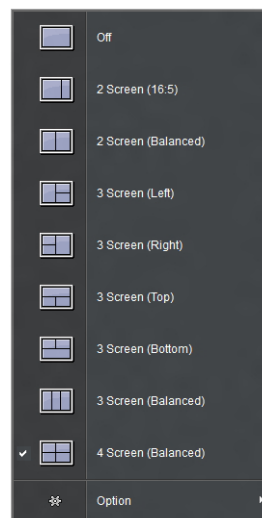

CUSTOMIZING SETTINGS

Accessing the Main Menus

The menus displayed on the TV screen may vary depending on the selected input mode.

TV, Component, AV

- 1 Press **SETTINGS** to access the main menus.
- 2 Press the Navigation buttons to scroll to one of the following menus and press **OK**.
- 3 Press the Navigation buttons to scroll to the setting or option you want and press **OK**.
- 4 When you are finished, press **EXIT**.
When you return to the previous menu, press  **BACK**.

PICTURE	Adjusts the image size, quality or effect.
AUDIO	Adjusts the sound quality, effect or volume level.
CHANNEL	Sets up and edit channels.
TIME	Sets the time, date or Timer feature.
LOCK	Locks or unlocks channels and programs.
OPTION	Customizes the general settings.
MY MEDIA	Using integrated media feature.

- Press **RED** button to access the **Customer Support** menus.



Press OK(⓪) to set your picture settings.

 Exit

 Customer Support

Customer Support
Using Customer Support feature.

- Picture Test
- Sound Test
- Product/Service Info.
- User Guide
- Patent Information



PICTURE



To adjust Aspect Ratio

SETTINGS> PICTURE> Aspect Ratio	Description
16:9	Resizes the image ratio to fit 16:9 screen.
21:9	Resizes the image ratio to fit 21:9 screen.
Just Scan	Displays the input signal without any reformatting. Select Just Scan at the input of DTV/Component.
Set by Program	Depending on the input signal, screen aspect ratio changes to 4:3 or 16:9.
4:3	Resizes the image ratio to fit 4:3 screen.
Zoom	Resizes the image to fit the screen width. The top and bottom parts of the image may be cut off.
Cinema Zoom 1	Formats an image to the cinemascope ratio (2.35:1) and zooms in on the ratio.

To select Picture Mode

SETTINGS> PICTURE> Picture Mode	Description
Select the picture mode optimized for the viewing environment or the program. Depending on input signal, available range of picture modes may differ.  Expert mode is for picture tuning professionals to control and fine-tune using a specific image. For normal images, the effects may not be drastic.	
Vivid / Standard / Cinema / Game	Select a Picture Mode of your choice.
Eco	The Energy Saver feature changes settings on the TV to reduce power consumption.
 Expert 1  Expert 2	Menu for adjusting picture quality that allows experts and amateurs to enjoy the best TV viewing. This menu for adjustment is provided for ISF-certified picture tuning professionals. (ISF logo can only be used on ISF-certified TVs.) ISFccc: Imaging Science Foundation Certified Calibration Control

To fine-tune picture mode

SETTINGS> PICTURE> Picture Mode> Backlight / Contrast / Brightness / Sharpness / Color / Tint / Color Temp.	Description
First select a Picture Mode of your choice. Depending on the input signal or other picture settings, the range of detailed items for adjustment may differ.	
Backlight	Adjusts the screen brightness by changing the brightness of the panel.
Contrast	Adjusts the color contrast and brightness of the screen.
Brightness	
Sharpness	Adjusts the sharpness of the screen.
Color	Adjusts the color depth of the screen.
Tint	Adjusts the gamma, color temperature and color of the screen.
Color Temp.	Adjusts the overall tint of the picture. In Expert mode, you can fine-tune the picture using the Gamma or Method options.

To set Expert Control

SETTINGS> PICTURE> Picture Mode> Advanced Control	Description
For each picture mode, screen can be calibrated; or for a special screen, picture settings can be adjusted. Select the desired Picture Mode. Depending on input signal or other picture settings, the range of detailed items for adjustment may differ.	
Dynamic Contrast	Adjusts the contrast to the optimal level according to the image's brightness.
Dynamic Color	Adjusts colors to make the image appear in more natural colors.
Skin Color	Skin color spectrum can be separately set to implement the skin color defined by the user.
Grass Color	Natural color spectrum (meadows, hills, etc.) can be separately set.
Sky Color	Sky color is set separately.
Gamma	Sets the gradation curve according to the output of picture signal in relation to the input signal.
SETTINGS> PICTURE> Picture Mode>Expert Control	Description
Dynamic Contrast	Adjusts the contrast to the optimal level according to the image's brightness.
Color Gamut	Selects the range of colors that can be expressed.
Edge Enhancer	Shows clearer and distinctive yet natural edges of the video.
Expert Pattern	Patterns used for expert adjustment.
Color Filter	Filters a specific color spectrum in RGB colors to fine-tune color saturation and hue accurately.
Color Temperature	Adjusts the overall tone of the screen as desired. In Expert mode, detailed fine-tuning can be set via Gamma method, etc.
Color Management System	This system is used by experts to adjust color with a test pattern. They can select from six color areas (Red/ Green/Blue/Cyan/Magenta/Yellow) without affecting other colors. For normal images, adjustments may not result in noticeable color changes.

To set Picture Option

SETTINGS> PICTURE> Picture Mode> Picture Option	Description
Adjusts detailed setting for images.	
Noise Reduction	Reduces screen noise in the video.
MPEG Noise Reduction	Eliminates noise generated while creating digital picture signals.
Black Level	Adjusts the screen's brightness and contrast to fit them to the input picture's black level by using the blackness (black level) of the screen.
Real Cinema	Helps maintain the optimal state of the screen.
Motion Eye Care	Saves power consumption by adjusting the brightness corresponding to the movement of the image on the screen.

To set Picture Reset

SETTINGS> PICTURE> Picture Mode> Picture Reset	Description
Initializes picture settings that the user customizes. Each picture mode is reset. Select the desired picture mode to reset.	



AUDIO

To use Sound Mode

SETTINGS> AUDIO> Sound Mode	Description
	Adjusts TV audio to an optimal level based on a selected sound mode.
Standard	Suitable for all types of video.
Music / Cinema / Sport / Game	Sets audio optimized for a specific genre.

To adjust User Setting function

SETTINGS> AUDIO> Sound Mode> User Setting	Description
	Adjusts the volume to a level of your choice using the User EQ.
Reset	Resets voice options that the user has changed.

To set various sound options

To use Virtual Surround feature

SETTINGS> AUDIO> Virtual Surround	Description
	LG's proprietary audio processing technology allows 5.1ch-like surround sound from two speakers. When Clear Voice II is set to On, Virtual Surround cannot be selected.

To adjust Clear Voice II function

SETTINGS> AUDIO> Clear Voice II	Description
	Boosts voice clarity from the TV.

To set Auto Volume

SETTINGS> AUDIO> Auto Volume	Description
	Sets Auto Volume to ON and volume output from channel to channel is automatically adjusted for convenient TV watching when clicking through different channels.

To set sound out

SETTINGS> AUDIO> Sound Out	Description
TV Speaker	Sound is output through the TV speaker.
Headphone	Sound is output through the headphone connected to the earphone/headphone port.

To set AV Sync

SETTINGS> AUDIO> AV Sync. Adjust	Description
	Synchronizes unmatched video and audio. Select AV Sync. Adjust to On to synchronize audio output (TV speaker) with the video.

To adjust audio balance

SETTINGS> AUDIO> Balance	Description
	Adjusts left/right audio balance.

To use Sound Optimizer function

SETTINGS> AUDIO> Sound Optimizer	Description
	Allows optimized sound for individual TV installation.
Normal	General sound mode.
Wall Mount Type	Optimizes sound for a wall-mounted TV.
Stand Type	Optimizes sound for a stand-mounted TV.



LOCK

To set the password

SETTINGS> LOCK> Set Password	Description
	Set or change the TV password. The initial password is set as [0000].

To lock the system

SETTINGS> LOCK> Lock System	Description
	Permits only specific programs by blocking channels. At first, select Lock System to ON .
Block Channel	Blocks the channels that contain inappropriate contents for children. To watch a locked channel, enter the password.
Rating	<ol style="list-style-type: none"> Block Channel : Blocks the channels that contain inappropriate contents for children. The Channels can be selected but the screen is blank and the audio is muted. To watch a locked channel, enter the password. Movie Rating[Depending on model] : Blocks the movies that are only broadcasted on the TV and contain inappropriate contents, based on the Motion Picture Association of America(MPAA) rating. <ul style="list-style-type: none"> G : (General audiences) All ages admitted PG : (Parental guidance suggested) Some material may not be suitable for children. PG-13 : (Parents strongly cautioned) Some material may be inappropriate for children under 13 R : (Restricted) Under 17 requires accompanying parent or adult guardian NC-17 : No one 17 and under admitted. X : Adults only TV Rating-Children [Depending on model] : Blocks the children's TV programs that parents do not want their children to watch. To block other TV programs, you should set the TV Rating-General feature. <ul style="list-style-type: none"> Age : TV-Y(All children, including children from ages 2-6), TV-Y7 (Directed to older children, suitable for children age 6 and above) Fantasy Violence : TY-Y7 (Directed to older children - Fantasy violence, suitable for children age 6 and above, containing more intense or combative fantasy violence) TV Rating-General : Blocks the TV programs that you want based on the ratings by using the Parental Control Function(V-Chip). <ul style="list-style-type: none"> The V-Chip electronically reads TV program ratings and allows parents to block program that are unsuitable for children. Age : TV-G(General audience, suitable for all ages) TV-PG(Parental guidance suggested, containing material that are unsuitable for younger children) TV-14(Parents strongly cautioned, containing material that are unsuitable for children age 14 and under) TV-MA(Mature audience only, unsuitable for children age under 17) Dialog : (suggestive dialogue) TV-PG, TV-14 Language : (coarse language) TV-PG, TV-14, or TV-MA Violence : TV-PG, TV-14, or TV-MA Downloadable Rating[In Digital mode Only] : This function operates only when TV has received Region5 Rating data. The name of the rating option may differ.

To use Key Lock

SETTINGS> LOCK> Key Lock	Description
	<p>Locks control buttons on the TV. Key Lock function remains intact even in case of power outage or when the power cord is removed from the wall socket. Key Lock function can only be set by remote control, and not by the button on the TV. Even with Key Lock ON, TV's buttons can turn on the power.</p>

DVI, HDMI1, HDMI2/MHL, DisplayPort

- 1 Press **SETTINGS** to access the main menus.
- 2 Press the Navigation buttons to scroll to one of the following menus and press **OK**.
- 3 Press the Navigation buttons to scroll to the setting or option you want and press **OK**.
- 4 When you are finished, press **EXIT**.
When you return to the previous menu, press **BACK**.



Each option is described below.

Menu	Description
Brightness	Adjusts the brightness and contrast of the screen.
Contrast	
Input	Selects the current input mode.
Ratio	Adjusts the screen ratio.
Func.	Adjusts SES and picture mode.
PIP	Displays the screens of two input modes on one monitor.
Picture	Adjusts the sharpness, black level, and response time of the screen.
Color	Adjusts the gamma, color temperature and color balance of the screen.
Settings	Sets the Language, PC/AV mode, Main Audio, Standby Light, DP 1.2 and Key Lock.
Reset	Resets to the default settings as of the day of purchase.
Exit	Exits the OSD menu.

Ratio Settings

- 1 Press **SETTINGS** to access the main menus.
- 2 Press the Navigation buttons to scroll to one of the following menus and press **OK**.
- 3 Press the Navigation buttons to scroll to the setting or option you want and press **OK**.
- 4 When you are finished, press **EXIT**.
When you return to the previous menu, press  **BACK**.



Ratio

Sub Menu



Wide Cinema1 Cinema2 Original 1:1 Back Exit

Each option is described below.

Menu > Ratio	Description
Wide	Displays the video in wide-screen, regardless of the video signal input.
Cinema1	Enlarges the screen with an aspect ratio of 21:9. (at 1080p)
Cinema2	Enlarges the screen with an aspect ratio of 21:9 including the black box area at the bottom for subtitles. (at 1080p)
Original	Displays a video according to the input video signal aspect ratio.
1:1	The aspect ratio is not adjusted from the original.
Back	Moves to the previous OSD screen.
Exit	Exits the OSD menu.

 **NOTE**

- The display may look the same for Wide, Original and 1:1 options at the recommended resolution (2560 x 1080).
- The ratio is disabled in the interlaced signal.

Func. Settings

- 1 Press **SETTINGS** to access the main menus.
- 2 Press the Navigation buttons to scroll to one of the following menus and press **OK**.
- 3 Press the Navigation buttons to scroll to the setting or option you want and press **OK**.
- 4 When you are finished, press **EXIT**.
When you return to the previous menu, press **BACK**.



Func.

Sub Menu

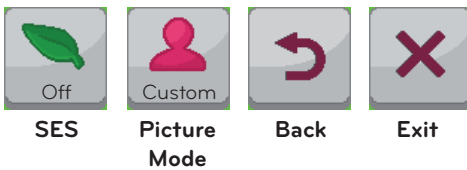

Each option is described below.

Menu > Func.	Description	
SES (Super Energy Saving)	On	Enables the SES function, which allows you to save energy according to the SES efficiency level.
	Off	Disables the SES function.
Picture Mode	Changes depending on the value of PC/AV Mode in Menu > Settings.	
	PC Mode	
	Custom	Allows the user to adjust each element. The color mode of the main menu can be adjusted.
	Text	Optimizes the screen for document processing.
	Photo	Optimizes the screen to view photos.
	Cinema	Optimizes the screen to improve the visual effects of a video.
	Game	Optimizes the screen for gameplay.
	AV Mode	
	Custom	Allows the user to adjust each element. The color mode of the main menu can be adjusted.
	Standard	Optimizes the screen to display normal picture quality.
	VIVID 1	Optimizes the screen for vivid visual effects.
VIVID 2	Optimizes the screen for more vivid visual effects.	
Cinema	Optimizes the screen to improve the visual effects of a video.	
Back	Moves to the previous OSD screen.	
Exit	Exits the OSD menu.	

PIP settings

- 1 Press **SETTINGS** to access the main menus.
- 2 Press the Navigation buttons to scroll to one of the following menus and press **OK**.
- 3 Press the Navigation buttons to scroll to the setting or option you want and press **OK**.
- 4 When you are finished, press **EXIT**.

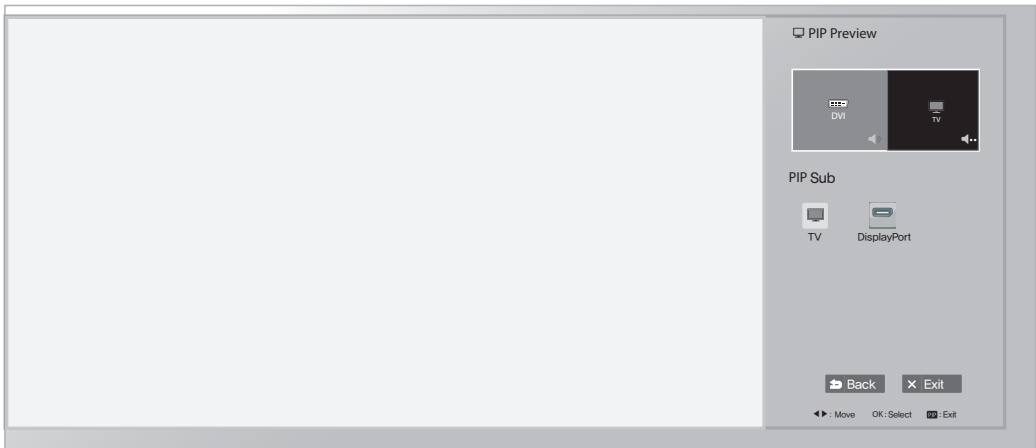

Each option is described below.

PIP Sub	Selects an option for PIP Sub. (See the PIP Map below.)						
	PIP Map		PIP Sub				
			DVI	HDMI1	HDMI2/ MHL	DisplayPort	TV
	current input	DVI	X	X	X	O	O
		HDMI1	X	X	X	O	O
		HDMI2/ MHL	X	X	X	O	O
		DisplayPort	O	O	O	X	O
TV	X	X	X	X	X		

Picture

- 1 Press **SETTINGS** to access the main menus.
- 2 Press the Navigation buttons to scroll to one of the following menus and press **OK**.
- 3 Press the Navigation buttons to scroll to the setting or option you want and press **OK**.
- 4 When you are finished, press **EXIT**.
When you return to the previous menu, press **↶ BACK**.



Picture

Sub Menu



Sharpness Black Level Response Time Reset Back Exit

Each option is described below.

Menu > Picture	Description	
Sharpness	Adjusts the sharpness of the screen.	
Black Level	Sets the offset level (for HDMI only). Offset: as a reference for a video signal, this is the darkest color the monitor can display.	
	High	The picture of the screen gets brighter.
	Low	The picture of the screen gets darker.
Response Time	Sets a response time for displayed pictures based on the speed of the screen. For a normal environment, it is recommended that you use Normal. For a fast-moving picture, it is recommended that you use High. Setting to High may cause image sticking.	
	High	Sets the response time to High.
	Middle	Sets the response time to Middle.
	Low	Sets the response time to Low.
Reset	Resets the Picture function to the default settings.	
Back	Moves to the previous OSD screen.	
Exit	Exits the OSD menu.	

Color

- 1 Press **SETTINGS** to access the main menus.
- 2 Press the Navigation buttons to scroll to one of the following menus and press **OK**.
- 3 Press the Navigation buttons to scroll to the setting or option you want and press **OK**.
- 4 When you are finished, press **EXIT**.
When you return to the previous menu, press **BACK**.



Color

Sub Menu



Each option is described below.

Menu > Color	Description
Gamma	Custom gamma setting: When using the gamma 0, gamma 1, and gamma 2 monitor settings, higher gamma settings mean a brighter image is displayed and vice versa.
Color Temp	Selects the factory default picture color. Warm: Sets the screen color to a reddish tone. Medium: Sets the screen color between a red and blue tone. Cool: Sets the screen color to a bluish tone.
	Custom You can customize the picture color.
Red / Green / Blue	You can customize the picture color using Red, Green, and Blue colors.
Six Color	Meets the user requirements for colors through adjusting the color and saturation of the six colors (red, green, blue, cyan, magenta, yellow) and saving the settings.
	Hue Adjusts tone of the screen. Saturation Adjusts the saturation of the screen colors. The lower the value, less saturated and bright the colors become. The higher the value, the more saturated and dark the colors become.
Reset	Returns the color settings to the default settings.
Back	Moves to the previous OSD screen.
Exit	Exits the OSD menu.

Settings

- 1 Press **SETTINGS** to access the main menus.
- 2 Press the Navigation buttons to scroll to one of the following menus and press **OK**.
- 3 Press the Navigation buttons to scroll to the setting or option you want and press **OK**.
- 4 When you are finished, press **EXIT**.
When you return to the previous menu, press **↶ BACK**.

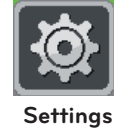

Sub Menu

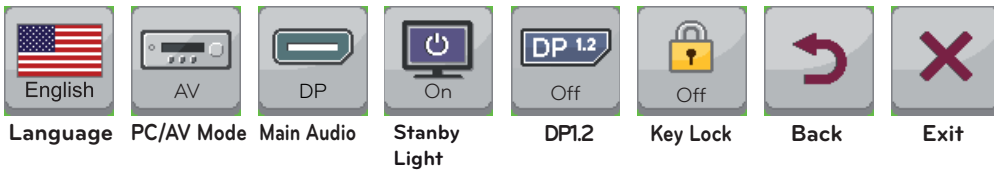

Each option is described below.

Menu > Settings	Description	
Language	Sets the menu screen to the desired language.	
PC/AV Mode	Enabled in HDMI mode only.	
Main Audio	The sound coming through the Audio In port of the digital input signal (HDMI, HDMI2/MHL, Display Port) can be heard through the monitor's speakers.	
Stanby Light	Turns the power indicator on the front side of the monitor on/off.	
	On	The Stanby Light is automatically turned on.
	Off	The Stanby Light is turned off.
DP1.2 (DisplayPort1.2)	Activates or deactivates DisplayPort 1.2.	
	<div style="border: 1px solid black; padding: 5px;"> <p>NOTE Make sure to activate or deactivate according to the DisplayPort version supported by the graphics card. Set it to off if it is not compatible with the graphics card.</p> </div>	
	On	DisplayPort 1.2 is activated.
	Off	DisplayPort 1.2 is deactivated.
Key Lock	Prevents incorrect key input.	
	On	Key input is disabled.
	Off	Key input is enabled.
Back	Moves to the previous OSD screen.	
Exit	Exits the OSD menu.	

USING THE USER GUIDE

NOTE

- This function is available only in TV, AV or Component input mode.

Accessing the On-Screen User Guide

- Press **SETTINGS** to access the main menus.
- Press the **RED** button to access the **Customer Support** menus.
- Press the Navigation button to scroll to **User Guide** and press **OK**.
- Press the Navigation buttons to scroll to the option you want and press **OK**.
- When you are finished, press **EXIT**.
When you return to the previous menu, press **BACK**.

- Image shown may differ from your TV.

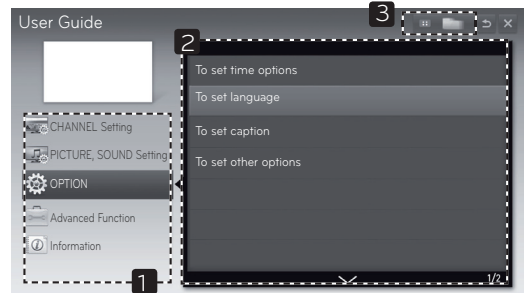

- Allows to select the category you want.
- Allows to select the item you want.
You can use **^**/**v** to move between pages.
- Allows to browse the description of the function you want from the index.

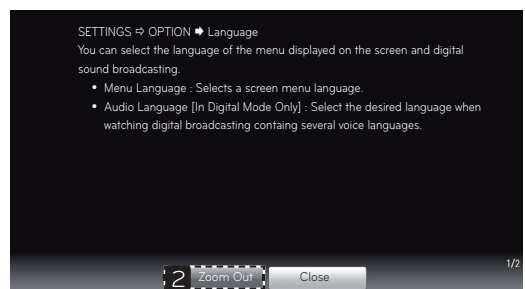

- Shows the description of the selected menu.
You can use **^**/**v** to move between pages.
- Zooms in or out the screen.

MAINTENANCE

Cleaning Your TV

Clean your TV regularly to keep the best performance and to extend the product's lifespan.



CAUTION

- Make sure to turn the power off and disconnect the power cord and all other cables first.
- When the TV is left unattended and unused for a long time, disconnect the power cord from the wall outlet to prevent possible damage from lightning or power surges.

Screen and frame

To remove dust, wipe the surface with a dry and soft cloth.

To remove major dirt, wipe the surface with a soft cloth dampened in clean water or a diluted mild detergent. Then wipe immediately with a clean and dry cloth.



CAUTION

- Do not push, rub, or hit the surface with your fingernail or a sharp object, as this may result in scratches on the screen and image distortions.
- Do not use any chemicals, such as waxes, benzene, alcohol, thinners, insecticides, air fresheners, lubricants, as these may damage the screen's finish and cause discolorations.

Cabinet and stand

To remove dust, wipe the cabinet with a dry and soft cloth.

To remove major dirt, wipe the cabinet with a soft cloth dampened in a clean water or water containing a small amount of mild detergent.



CAUTION

- Do not spray liquid onto the surface. If water enters the TV, it may result in fire, electric shock, or malfunction.
- Do not use any chemicals as this may deteriorate the surface.

Power cord

Remove the accumulated dust or dirt on the power cord regularly.

Preventing "Image burn" or "Burn-in" on your TV screen

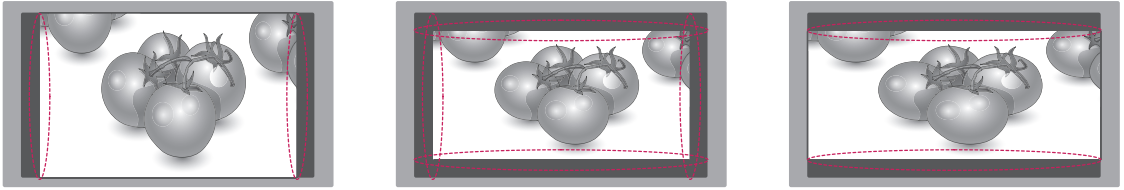

- If a fixed image displays on the TV screen for a long period of time, it will be imprinted and become a permanent disfigurement on the screen. This is "image burn" or "burn-in" and not covered by the warranty.
- If the aspect ratio of the TV is set to 4:3 for a long period of time, image burn may occur on the letterboxed area of the screen.
- Avoid displaying a fixed image on the TV screen for a long period of time (2 or more hours for LCD) to prevent image burn.

TROUBLE SHOOTING

Nothing is displayed on the screen.	
Is the monitor's power cord plugged in?	<ul style="list-style-type: none"> • Check if the power cord is correctly plugged in to the power outlet.
Is the power indicator on?	<ul style="list-style-type: none"> • Check the power cable connection and press the power button.
Is the power indicator displaying red?	<ul style="list-style-type: none"> • Check that the connected input is enabled (Menu - Input).
Is the power indicator blinking?	<ul style="list-style-type: none"> • If the monitor is in power-saving mode, move the mouse or press any key on the keyboard to switch the display on. • Check if the computer is turned on.
Is the "OUT OF RANGE" message displayed?	<ul style="list-style-type: none"> • This occurs when signals transferred from the PC (video card) are out of the horizontal or vertical frequency range of the monitor. Please see the "Product Specification" section of this manual to set the appropriate frequency.
Is the "CHECK SIGNAL CONNECTION" message is displayed?	<ul style="list-style-type: none"> • This is displayed when the signal cable between the PC and the monitor is missing or disconnected. Check the cable and reconnect.

The "OSD LOCKED" message is displayed.	
Are some functions unavailable when pressing the Menu button?	<ul style="list-style-type: none"> • The OSD is locked. Go to Menu > Settings and set "OSD Lock" to Unlock.

The screen retains an image.	
Does image sticking occur even when the monitor is turned off?	<ul style="list-style-type: none"> • Displaying a still image for a prolonged time may cause damage to the screen, resulting in the retention of the image. • Use a screen saver to protect the screen when using the monitor for a prolonged period of time.

! NOTE

- **Vertical Frequency:** In order to display an image, the screen must be refreshed dozens of times per second like a fluorescent lamp. The number of times the screen is refreshed per second is called vertical frequency or refresh rate and is represented by Hz.
- **Horizontal Frequency:** The time it takes to display one horizontal line is called the horizontal cycle. The number of horizontal lines displayed in one second can be calculated by dividing one by the horizontal cycle. This is called horizontal frequency and is represented by kHz.

! NOTE

- Check if the video card's resolution or frequency is within the range allowed by the monitor and set to the recommended (optimal) resolution in **Control Panel > Display > Settings**.
- Failing to set the video card to the recommended (optimal) resolution may result in blurred text, a dimmed screen, a truncated display area or misalignment of the display.
- The configuration procedure may differ depending on your computer and/or operating system. Also, some video cards may not support certain resolutions. If this is the case, contact the manufacturer of the computer or video card for assistance.
- Some video cards may not support the 2560x1080 resolution. If the resolution cannot be displayed, contact the manufacturer of your video card.

The display color is abnormal.	
Does the display appear discolored (16 color)?	<ul style="list-style-type: none"> • Set the color to 24 bit (true color) or higher. In Windows, go to Control Panel > Display > Settings > Color Quality.
Does the display color appear unstable or in monochrome?	<ul style="list-style-type: none"> • Check if the signal cable is connected properly. Reconnect the cable or reinsert the PC's video card.
Are there spots on the screen?	<ul style="list-style-type: none"> • When using the monitor, pixilated spots (red, green, blue, white or black) may appear on the screen. This is normal for the LCD screen. It is not an error nor is it related to the monitor's performance.

SPECIFICATIONS

Television System	NTSC-M, ATSC, 64 & 256 QAM
Program Coverage	VHF 2-13, UHF 14-69, CATV 1-135, DTV 2-69, CADTV 1-135

29MA73D 29LN450W

Panel	Screen Type	29" class (28.7" / 73 cm diagonal)
	Pixel Pitch	0.2628 mm (H) x 0.2628 mm (V)
Video Signal	Max. Resolution	2560 x 1080 @ 60 Hz
	Recommended Resolution	2560 x 1080 @ 60 Hz
	Horizontal Frequency	30 kHz to 90 kHz
	Vertical Frequency	56 Hz to 75 Hz
	Synchronization Type	Separate Sync, Digital
Input Connector		TV, PC Audio In, Component, AV(CVBS), HDMI*2, USB, DP, DVI-D
Power	Rated Voltage	19 V --- 3.2 A
	Power Consumption	On Mode : 52 W (typ.) Off Mode ≤ 0.5 W
AC/DC Adapter		Manufacturer : LG Innotek, Model : PSAB-L206A Manufacturer : APD, Model : DA-65F19
Tilt	Tilt Range	-5 to 20°
Dimensions (Width x Depth x Height) Weight		With Stand
		699.7 mm x 197.2 mm x 404.5 mm 5.9 kg
		Without Stand
		699.7 mm x 68.5 mm x 327.5 mm 5.3 kg
Environmental conditions	Operating Temperature	10 °C to 35 °C
	Operating Humidity	20 % to 80 %
	Storage Temperature	-10 °C to 60 °C
	Storage Humidity	5 % to 90 %

Product specifications shown above may be changed without prior notice due to upgrade of product functions.

DVI-D / HDMI / DisplayPort(PC) supported mode

Resolution	Horizontal Frequency(kHz)	Vertical Frequency(Hz)
720 x 400	31.468	70.080
640 x 480	31.469	59.940
640 x 480	37.500	75.000
800 x 600	37.879	60.317
800 x 600	46.875	75.000
1024 x 768	48.363	60.004
1024 x 768	60.023	75.029
1152 x 864	67.500	75.000
1280 x 720	45.000	60.000
1280 x 1024	63.981	60.020
1280 x 1024	79.976	75.025
1600 x 900	60.000	60.000
1680 x 1050	65.290	59.954
1920 x 1080	67.500	60.000
2560 x 1080	66.700	60.000

**NOTE**

- The recommended resolution is 2560x1080/60Hz. However, it may not be supported depending on your PC or AV model.

HDMI / MHL(VIDEO) supported mode

Resolution	Horizontal Frequency(kHz)	Vertical Frequency(Hz)
720 x 480	31.500	60.000
720 x 576	31.250	50.000
1280 x 720	37.500	50.000
1280 x 720	45.000	60.000
1920 x 1080	33.750	60.000
1920 x 1080	28.125	50.000
1920 x 1080	27.000	24.000
1920 x 1080	33.750	30.000
1920 x 1080	56.250	50.000
1920 x 1080	67.500	60.000

Component supported mode

Resolution	Horizontal Frequency(kHz)	Vertical Frequency(Hz)
720 x 480	15.730	59.940
720 x 480	15.750	60.000
720 x 576	15.625	50.000
720 x 480	31.470	59.940
720 x 480	31.500	60.000
720 x 576	31.250	50.000
1280 x 720	44.960	59.940
1280 x 720	45.000	60.000
1280 x 720	37.500	50.000
1920 x 1080	33.720	59.940
1920 x 1080	33.750	60.000
1920 x 1080	28.125	50.000
1920 x 1080	56.250	50.000
1920 x 1080	67.432	59.940
1920 x 1080	67.500	60.000

Component port connecting information

Component ports on the TV	Y	P _B	P _R
Video output ports on DVD player	Y	P _B	P _R
	Y	B-Y	R-Y
	Y	Cb	Cr
	Y	P _b	P _r

**NOTE**

- Avoid keeping a fixed image on the set's screen for prolonged periods of time. The fixed image may become permanently imprinted on the screen. Use a screen saver when possible.
- There may be interference relating to resolution, vertical pattern, contrast or brightness in PC mode. Change the PC mode to another resolution or change the refresh rate to another rate or adjust the brightness and contrast on the menu until the picture is clear. If the refresh rate of the PC graphic card can not be changed, change the PC graphic card or consult the manufacturer of the PC graphic card.
- The synchronization input waveform for Horizontal and Vertical frequencies are separate.
- Connect the audio cable from the PC to the Audio input on the TV.
- If using a sound card, adjust PC sound as required.



LG

Life's Good

Only for 29LN450W



This product qualifies for ENERGY STAR in the "factory default (Home Use)" setting.

Changing the factory default settings or enabling other features may increase power consumption that could exceed the limits necessary to qualify for ENERGY STAR.

Make sure to read the Safety Precautions before using the product.

Keep the Owner's Manual (CD) in an accessible place for future reference.

The model and serial number of the TV is located on the back and one side of the TV. Record it below should you ever need service.

MODEL _____

SERIAL _____

Declaration of Conformity

Trade Name: LG

Model : 29MA73D / 29LN450W

Responsible Party: LG Electronics Inc.

Address : 1000 Sylvan Ave.

Englewood Cliffs NJ 07632

U.S.A

TEL: 201-266-2534

To obtain the source code under GPL, LGPL, MPL and other open source licenses, that is contained in this product, please visit <http://opensource.lge.com>.

In addition to the source code, all referred license terms, warranty disclaimers and copyright notices are available for download. LG Electronics will also provide open source code to you on CD-ROM for a charge covering the cost of performing such distribution (such as the cost of media, shipping and handling) upon email request to opensource@lge.com. This offer is valid for three (3) years from the date on which you purchased the product.

CHILD SAFETY:

It Makes A Difference How and Where
You Use Your Flat Panel Display

Congratulations on your purchase! As you enjoy your new product, please keep these safety tips in mind:



THE ISSUE

- The home theater entertainment experience is a growing trend and larger flat panel displays are popular purchases. However, flat panel displays are not always supported on the proper stands or installed according to the manufacturer's recommendations.
- Flat panel displays that are inappropriately situated on dressers, bookcases, shelves, desks, speakers, chests or carts may fall over and cause injury.

THIS MANUFACTURER CARES!

- The consumer electronics industry is committed to making home entertainment enjoyable and safe.

TUNE INTO SAFETY

- One size does NOT fit all. Follow the manufacturer's recommendations for the safe installation and use of your flat panel display.
- Carefully read and understand all enclosed instructions for proper use of this product.
- Don't allow children to climb on or play with furniture and television sets.
- Don't place flat panel displays on furniture that can easily be used as steps, such as a chest of drawers.
- Remember that children can become excited while watching a program, especially on a "larger than life" flat panel display. Care should be taken to place or install the display where it cannot be pushed, pulled over, or knocked down.
- Care should be taken to route all cords and cables connected to the flat panel display so that they cannot be pulled or grabbed by curious children.

WALL MOUNTING: IF YOU DECIDE TO WALL MOUNT YOUR FLAT PANEL DISPLAY, ALWAYS:

- Use a mount that has been recommended by the display manufacturer and/or listed by an independent laboratory (such as UL, CSA, ETL).
- Follow all instructions supplied by the display and wall mount manufacturers.
- If you have any doubts about your ability to safely install your flat panel display, contact your retailer about professional installation.
- Make sure that the wall where you are mounting the display is appropriate. Some wall mounts are not designed to be mounted to walls with steel studs or old cinder block construction. If you are unsure, contact a professional installer.
- A minimum of two people are required for installation. Flat panel displays can be heavy.



 **CEA**
Consumer Electronics Association
www.CE.org/safety

P/NO : 3840TRL098E (0801-REV00)