

Power source	ON SPECIFICATION LABEL
Capacity (Wash/Spin)	On Specification Label
Water Level	H : 50 Litres
Water Pressure	Less than 100kPa (1kgf/cm <sup>2</sup> )
Dimension	700 x 430 x 920 mm. (W x D x H)
Weight	For Non-Pump Model 19 kg
	For Pump Model 20.5 kg

How to read the manufactured month and year from the label stuck on the back of the product.

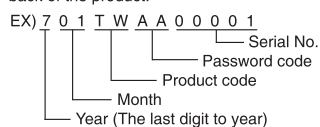

Main service part list : Refer to below listed part name when you need service call.

Part name	Remark
- WASH MOTOR	90 W (Output)
- SPIN MOTOR	25-40 W (Output)
- S.D.BASKET	PLASTIC
- CYCLE TIMER ASSEMBLY	
- CAPACITOR	
- GEAR CASE ASSEMBLY	

P/No. : MFL38271101

Rev. : 02

## OWNER'S MANUAL

# WASHING MACHINE

Please read this manual carefully before operating your washing machine and retain it for future reference.

WP-750(N,R)(P)/WP-800(N,R)(P)  
 WP-791(N,R)(P)/ P302R  
 WP-760R /WP-650N  
 WP-650N2/WP-750R2/WP-800R2  
 WP-701N

Specification  
 (R,N) : Pulsator Type  
 (P) : Pump Model Only  
[www.lg.com](http://www.lg.com)

P/No. : MFL38271101

## CAUTION

### READ ALL SAFETY INFORMATION AND INSTALLATION INSTRUCTIONS BEFORE USE.

**Follow all instructions in this manual to minimize the risk of fire, electric shock and to prevent property damage, personal injury or loss of life.**

<p><b>Installation</b></p> <ul style="list-style-type: none"> <li>Do not install in areas exposed to snow, rain or to the weather.</li> <li>Install the washing machine on a horizontal support. Otherwise it may cause vibration and noise.</li> </ul> <p><b>Switch Area</b></p> <ul style="list-style-type: none"> <li>Avoid watering on the switch area. It may cause electric shock or fire.</li> </ul> <p><b>Spin Motor</b></p> <ul style="list-style-type: none"> <li>After continuous using spinning program 3 times, please stop spinning more than 1 hour. Otherwise the spin motor could be damaged or fired.</li> </ul> <p><b>In Operation</b></p> <ul style="list-style-type: none"> <li>Do not put your hand into the spin dryer basket while the machine is in operation.</li> <li>Do not drain the water out of the wash tub while the spin dryer basket is in operation. Otherwise the spin motor could be damaged.</li> <li>If during spinning, opening the lid does not stop the spin dryer basket within about 15 sec, immediately unplug and contact service.</li> </ul> <p><b>Electric Outlet</b></p> <ul style="list-style-type: none"> <li>Avoid connecting several electric devices to single outlet. It may cause fire.</li> </ul>	<p><b>Volatile Material</b></p> <ul style="list-style-type: none"> <li>Do not use volatile material such as Benzene, Gasoline, kerosene, Insecticide.</li> <li>Do not leave strong alkaline substance such as bleach inside the tub. Damage on plastic surface and rubber parts may occur.</li> </ul> <p><b>Hot water</b></p> <ul style="list-style-type: none"> <li>Avoid using hot water over 50°C. It may deform plastic parts or cause malfunction.</li> </ul> <p><b>Heat</b></p> <ul style="list-style-type: none"> <li>Avoid electric heater, candle light, cigarette light, bug smoker, etc. near the machine. It may ignite or deform plastic part.</li> </ul> <p><b>Power Cord and Plug</b></p> <ul style="list-style-type: none"> <li>Do not damage, bend, distort or place any heavy objects on it.</li> <li>If the supply cord is damaged, it must be replaced by the manufacturer or its service agent or a similarly qualified person.</li> <li>Wipe off dirt or dust on the contacts of the power plug. It may cause fire.</li> <li>Do not touch a power plug with a wet hand. It may cause electric shock.</li> <li>Unplug the supply cord when not using the washing machine for a long time.</li> </ul>
---	---

• This appliance is not intended for use by persons (including children) with reduced physical, sensory or mental capabilities, or lack of experience and knowledge, unless they have been given supervision or instruction concerning use of the appliance by person responsible for their safety. Children should be supervised to ensure that they do not play with the appliance.

• Do not allow children to play on, with, or inside the washing machine.

• Do not step on the washing machine or place any heavy objects on it.

• Do not wash, rinse or spin dry the waterproof sheets and clothes.

• Connect the washing machine to a grounded outlet in accordance with all local codes and ordinances.

• Disconnect the power supply before cleaning or performing maintenance. Unplug the power cord by grasping the plug with dry hands. Never grasp the cord.

• The units should not be repaired, disassembled or modified by any person except the authorized technicians.

• This product may only be sold in Asia, Middle East and African countries and complies with the regulatory requirements in these countries.

• This product may not be sold outside these territories.

• LG Electronics cannot guarantee and is not responsible for the compliance of this product with the regulatory requirements in other regions/countries.

• A precaution indicates that the washing machine shall not be installed at a humid place.

• A precaution on the washing machine whose lid can be opened during water extraction, that if it takes 15 s or more for complete stop of water-extracting chamber tub such a case should be understood as a trouble.

• If this product is used for commercial purpose, it is not warranted.  
 (Example : Public places such as public bathroom, lodging house, training center, dormitory)  
 If the product is installed outside the normal service area, any cost of transportation involved in the repair of the product, or the replacement of a defective part, shall be borne by the owner.

Remark : Avoid using hot water over 60°C. (Only for Saudi Arabia Country)

## FEATURES

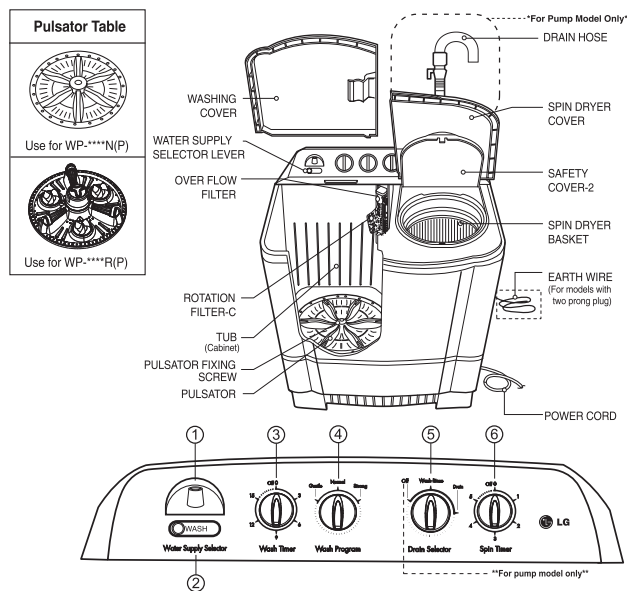

- Water Supply Inlet**  
Connect here with the inlet hose from the water faucet to feed water to the tub.
- Water Selector**  
Select "WASH" to supply water for washing and rinsing and "SPIN" for spin shower rinse.
- Wash Timer**  
Select the desired time for washing or rinsing.
- Wash Program**  
Set the program to "Gentle", "Normal", "Strong" according to kinds and quantity of the laundry.
- Drain Selector**  
• **For Non-Pump Model**  
Select "Wash • Rinse" for washing and rinsing and "Drain" to drain the water out of the tub.

- **For Pump Model**  
Select "Wash • Rinse" for washing, rinsing and turn off the drain pump and "Drain" to drain the water out of Cabinet, and "Off" to turn off the drain pump.
- 6. Spin Timer**  
Connect here with the inlet hose from the water faucet to feed water to the tub.  
 \*\*After continue using spinning program 3 times continue, Please stop spinning more than 1 hour otherwise the spin motor could be damage of fire or stop operation.  
 \*\*\*To obtain an efficient performance according to energy label according to energy label, Wash program 30 mins (60 °C), Rinse 2 times, Spin 1 times should be applied.  
 (Only for Saudi Arabia Country)

# INSTALLATION

## Installation area

- Set on flat and firm floor
- Incorect installation may cause severe noise and break down.



- Maintain more than 10 cm between the side of drain hose and the wall.
- A carpet must not obstruct the ventilation openings.



## Connecting the earth wire

- Install the earth wire to prevent short-circuit due to leaking current and electric shock.
- It is attached at the back of the washer.
- Connect it to the metal water pipe. If the water pipe is made of plastic, it does not have the earth effect.
- Do not connect the earth wire to the gas pipe, lightning arrester, telephone connector, etc.

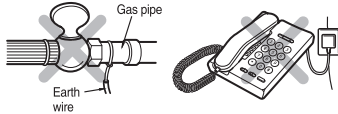

※ Warning-the appliance with two-pronged plug must be grounded.

## Connecting the power plug

- Insert the power plug into the outlet.
- Before connecting the power plug, check if the voltage setting of the washer matches the out let voltage.
- If AC outlet with ground terminal is used, grounding is not needed. If not, never forget earthing (Refer earthing method above).
- The appliance must be positioned so that the plug is accessible.

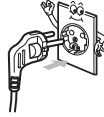

## Voltage Change (only for dual voltage)

- This washer is assembled for 220V, but can be changed from 220V to 110V(or 127V).
- Check your electrical source and follow the diagram below to convert voltage.

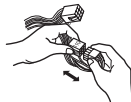

## Other earthing method

- After connecting the earth wire to the earth copper plate, bury it at least 75cm deep under the wet ground.
- Connect to the earthing-only outlet.
- When installing it in an area where earthing is not possible, purchase a short-circuit breaker connect it to the outlet.

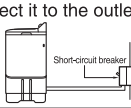
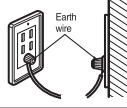
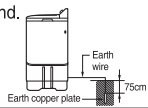

## Connecting the drain hose

### For Non-Pump Model

- Be sure to reroute the hose so that it is not kinked; kinks or sharp bending in the hose will prevent proper drainage.
- Make sure water is drained smoothly by placing a base under the machine or by applying other appropriate mean.

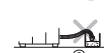
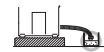

### For Pump Model

- L <= 1 m.

4



# INSTALLATION & HOW TO WASH

## Before washing

1. Check the washing instruction labels on the clothing to be washed.
2. Remove all objects from the pockets of the clothing. Objects left in the pockets may damage clothing or break the washing machine (could cause the drain hose to clog).
3. After separating oiled or dyed clothing, wash.
4. For your convenience hang up the wash cover on the right or left side of the washing machine tub when not in use.

## Remove this before washing



## How to wash

**1** Set the drain selector  
*For Non-Pump Model*, *For Pump Model*  
Set as "off" position, Wash-Rinse Drain position.

**3** Open water supply and fill water till water level mark "H". That is because clothes can absorb adequate amount of water and water will not short.

**2** Set the water selector to "WASH"

**4** Put the appropriate amount of detergent and the laundry into the wash tub. And add water to the desired water level which you want.

**5** Select the wash program to "Gentle", "Normal" or "Strong" according to the kinds and quantity of the laundry. (Refer to Tabel 2)  
Gentle Normal Strong

**6** Set the desired wash time.

**7** When washing is finished, locate the drain selector to "Drain" position and drain the water out.

**8** Spinning in the spin dryer basket. Move the laundry into the spin dryer basket. Put the laundry down lightly. Place the safety cover horizontally on the laundry. Set the desired spin time with the spin timer.

5

# HOW TO RINSE & HOW TO SPIN

## Inter spin rinse

- Interim spin rinse prior to regular rinsing helps removing sudsy water from the laundry and improve rinsing efficiency. Also is helpful to water saving.

**1** After washing.  
• Move the laundry into the spin dryer basket.  
• Place the safety cover horizontally on the laundry.

**2** Set the water selector to "SPIN"

**4** After interim spin rinse, move the laundry into the wash tub for rinsing.

**3** Set the desired spin flow appropriately.

## Note for spinning

1. Put the laundry evenly into the spin dryer basket.
2. Put the laundry down lightly.
3. Place the safety cover horizontally over the laundry, washing machine will be damage if the safety cover is not placed.
4. Close the spin dryer cover.
5. Do not drain the water out of wash tub while the spin dryer basket is in operation.
- If the spin dryer basket is off-balance and vibrates excessively, stop the spinning, rearrange the clothes evenly, and then resume spinning.

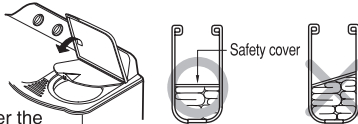

# CARE

## Overflow filter & Rotation filter-C

1. Pull the overflow filter forward from the wash tub in the direction of the arrow.
2. Lift up the area ④ of the over flow filter and take out the rotation filter-C by pulling in direction as shown.
3. Turn the net over and rinse in water.
4. Use a brush or hand to remove all of the lint which has adhered to the overflow filter.
5. Insert the overflow filter back into the wash tub.
6. Insert the rotation filter-C back into the overflow filter.

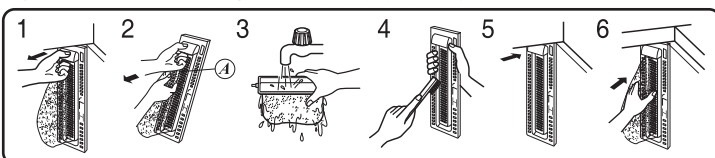

6

# REFERENCE

TABLE 1. WEIGHT GUIDE FOR CLOTHES

Type of clothing	Type of fabric	Weight per piece
Under shirt	Cotton	150g(53.0oz)
Handkerchief	Cotton	50g( 1.8oz)
Bath towel	Cotton	300g(10.6oz)
Shirt	Mixed fabric	200g( 7.1oz)
Socks (1 pair)	Mixed fabric	50g( 1.8oz)
Pajama (shirt and pants)	Cotton	500g(17.6oz)
Winter undershirt	Cotton	600g(21.2oz)
Workclothes	Mixed fabric	800g(28.2oz)
Blouse	Mixed fabric	200g( 7.1oz)

TABLE 2. GUIDE FOR WASHING

Type of fabric	Wash Selector	Wash Time	Amount of laundry	Water Level	Amount of Water	Amount of detergent
Synthetics, Silk, Woolen, Knits	Gentle	2 ~ 5 min.	0.5 ~ 2 kg	-	30 l	30 g
Cotton, Linen	Normal	5 ~ 10 min.	2 ~ 3 kg	-	40 l	40 g
Very soiled cotton and linen	Strong	10 ~ 15 min.	3 kg~	H	50 l	50 g

- Amount of laundry is based on dry laundry.
- Detergent amount is based on a general synthetic detergent.
- If washing and spinning must be operated together, starting washing and spinning operation shall be done at the same time to cope with EMC requirement.

# TROUBLESHOOTING GUIDE

## Before Requesting Service

Problem	Checking point
Motor does not operate,	<ul style="list-style-type: none"> <li>• Is the power cord firmly plugged in?</li> <li>• Is the timer turned to a suitable point except "Off" ?</li> </ul>
Spin dryer basket does not operate.	<ul style="list-style-type: none"> <li>• Is there any clothing dropped between the basket and tub?</li> <li>• Is the spin dryer cover closed?</li> <li>• Is the laundry gathered to one side of the spin dryer basket?</li> </ul>
No draining <i>For Non-Pump Model</i> <i>For Pump Model</i>	<ul style="list-style-type: none"> <li>• Is there lint stuck in the plunger valve?</li> <li>• Is the end of the drain hose guide located at an exceed height?</li> <li>• Is the drain pump operated?</li> </ul>

7