



# OWNER'S MANUAL

## DVD Player

Please read this manual carefully before operating your set and retain it for future reference.

DP430 / DP431 / DP432 / DP437



MFL67859941



## Safety Information



**CAUTION:** TO REDUCE THE RISK OF ELECTRIC SHOCK DO NOT REMOVE COVER (OR BACK) NO USER-SERVICEABLE PARTS INSIDE REFER SERVICING TO QUALIFIED SERVICE PERSONNEL.



This lightning flash with arrowhead symbol within an equilateral triangle is intended to alert the user to the presence of uninsulated dangerous voltage within the product's enclosure that may be of sufficient magnitude to constitute a risk of electric shock to persons.



The exclamation point within an equilateral triangle is intended to alert the user to the presence of important operating and maintenance (servicing) instructions in the literature accompanying the product.

**WARNING:** TO PREVENT FIRE OR ELECTRIC SHOCK HAZARD, DO NOT EXPOSE THIS PRODUCT TO RAIN OR MOISTURE.

**WARNING:** Do not install this equipment in a confined space such as a book case or similar unit.

**CAUTION:** Do not block any ventilation openings. Install in accordance with the manufacturer's instructions.

Slots and openings in the cabinet are provided for ventilation and to ensure reliable operation of the product and to protect it from over heating. The openings shall be never be blocked by placing the product on a bed, sofa, rug or other similar surface. This product shall not be placed in a built-in installation such as a bookcase or rack unless proper ventilation is provided or the manufacturer's instruction has been adhered to.

**CAUTION:** This product employs a Laser System. To ensure proper use of this product, please read this owner's manual carefully and retain it for future reference. Shall the unit require maintenance, contact an authorized service center. Use of controls, adjustments or the performance of procedures other than those specified herein may result in hazardous radiation exposure. To prevent direct exposure to laser beam, do not try to open the enclosure. Visible laser radiation when open. DO NOT STARE INTO BEAM.

### CAUTION concerning the Power Cord

Most appliances recommend they be placed upon a dedicated circuit;

That is, a single outlet circuit which powers only that appliance and has no additional outlets or branch circuits. Check the specification page of this owner's manual to be certain. Do not overload wall outlets. Overloaded wall outlets, loose or damaged wall outlets, extension cords, frayed power cords, or damaged or cracked wire insulation are dangerous. Any of these conditions could result in electric shock or fire. Periodically examine the cord of your appliance, and if its appearance indicates damage or deterioration, unplug it, discontinue use of the appliance, and have the cord replaced with an exact replacement part by an authorized service center. Protect the power cord from physical or mechanical abuse, such as being twisted, kinked, pinched, closed in a door, or walked upon. Pay particular attention to plugs, wall outlets, and the point where the cord exits the appliance. To disconnect power from the mains, pull out the mains cord plug. When installing the product, ensure that the plug is easily accessible.

This device is equipped with a portable battery or accumulator.

**Safety way to remove the battery or the battery from the equipment:** Remove the old battery or battery pack, follow the steps in reverse order than the assembly. To prevent contamination of the environment and bring on possible threat to human and animal health, the old battery or the battery put it in the appropriate container at designated collection points. Do not dispose of batteries or battery together with other waste. It is recommended that you use local, free reimbursement systems batteries and accumulators. The battery shall not be exposed to excessive heat such as sunshine, fire or the like.

**CAUTION:** The apparatus shall not be exposed to water (dripping or splashing) and no objects filled with liquids, such as vases, shall be placed on the apparatus.

### Notes on Copyrights

- This item incorporates copy protection technology that is protected by U.S. patents and other intellectual property rights of Rovi Corporation. Reverse engineering and disassembly are prohibited.
- Under the U.S. Copyright laws and Copyright laws of other countries, unauthorized recording, use, display, distribution, or revision of television programs, videotapes, DVDs, CDs and other materials may subject you to civil and/or criminal liability.

### Notes on Discs

- Do not touch the playback side of the disc. Hold the disc by the edges so that fingerprints do not get on the surface. Never stick paper or tape on the disc.
- After playing, store the disc in its case. Do not expose the disc to direct sunlight or sources of heat and never leave it in a parked car exposed to direct sunlight.

### Notes on the Unit

- Please save the original shipping carton and packing materials. If you need to ship the unit, for maximum protection, re-pack the unit as it was originally packed at the factory.
- To clean the unit, use a soft, dry cloth. If the surfaces are extremely dirty, use a soft cloth lightly moistened with a mild detergent solution. Do not use strong solvents such as alcohol, benzine, or thinner, as these might damage the surface of the unit.
- The unit is a high-tech, precision device. If the optical pick-up lens and disc drive parts are dirty or worn, the picture quality could be diminished. For details, please contact your nearest authorized service center.

# Important Safety Instructions

1. Read these instructions.
2. Keep these instructions.
3. Heed all warnings.
4. Follow all instructions.
5. Do not use this apparatus near water.
6. Clean only with dry cloth.
7. Do not block any ventilation openings. Install in accordance with the manufacturer's instructions.
8. Do not install near any heat sources such as radiators, heat registers, stoves, or other apparatus (including amplifiers) that produce heat.
9. Do not defeat the safety purpose of the polarized or grounding-type plug. A polarized plug has two blades with one wider than the other. A grounding type plug has two blades and a third grounding prong. The wide blade or the third prong are provided for your safety. If the provided plug does not fit into your outlet, consult an electrician for replacement of the obsolete outlet.
10. Protect the power cord from being walked on or pinched particularly at plugs, convenience receptacles, and the point where they exit from the apparatus.
11. Only use attachments/accessories specified by the manufacturer.
12. Use only the cart, stand, tripod, bracket, or table specified by the manufacturer, or sold with apparatus. When a cart is used, use caution when moving the cart/apparatus combination to avoid injury from tip-over.
13. Unplug this apparatus during lightning storms or when unused for long periods of time.
14. Refer all servicing to qualified service personnel. Servicing is required when the apparatus has been damaged in any way, such as power-supply cord or plug is damaged, liquid has been spilled or objects have fallen into the apparatus, the apparatus has been exposed to rain or moisture, does not operate normally, or has been dropped.



# Table of Contents

## 1 Getting Started

---

- 2 Safety Information
- 6 Introduction
  - 6 – About the “Q” Symbol Display
  - 6 – Symbols Used in this Manual
  - 6 – Supplied Accessories
  - 6 – Playable Discs
  - 6 – Regional Code
  - 7 – File Compatibility
- 8 Remote Control
- 9 Front Panel
- 9 Rear Panel

## 2 Connecting

---

- 10 Connecting to your TV
  - 10 – Connecting Video / Audio Cable
  - 10 – Connecting Component Video Cable
- 11 Connecting to an Amplifier
  - 11 – Connecting Audio Cable
  - 11 – Connecting COAXIAL (digital audio) Cable

## 3 System Setting

---

- 12 Settings
  - 12 – Adjust the Setup Settings
  - 12 – [LANGUAGE] Menu
  - 12 – [DISPLAY] Menu
  - 12 – [AUDIO] Menu
  - 13 – [LOCK] Menu
  - 13 – [OTHERS] Menu

## 4 Operating

---

- 14 General Playback
  - 14 – Playing a Disc
  - 14 – Playing a File
  - 14 – Playing a Karaoke Disc (DP431/DP437 only)
  - 14 – On-Screen Display
- 15 General Operation
- 15 Advanced Playback
  - 15 – Movie
  - 16 – Music
  - 17 – Photo

## 5 Troubleshooting

---

- 18 Troubleshooting

## 6 Appendix

---

- 19 Area Code List
- 20 Language Code List
- 21 Specifications
- 21 Trademarks and Licenses

1

2

3

4

5

6





# Introduction

## About the “⊘” Symbol Display

“⊘” may appear on your TV display during operation and indicates that the function explained in this owner’s manual is not available on that specific media.

## Symbols Used in this Manual

A section whose title has one of the following symbols are applicable only to the disc or file represented by the symbol.

	DVD-Video, DVD±R/RW
	Audio CDs
	Video files contained in the USB/Disc (USB: DP432/DP437 only)
	Audio files contained in the USB/Disc (USB: DP432/DP437 only)
	Photo files contained in the USB/Disc (USB: DP432/DP437 only)

## Supplied Accessories

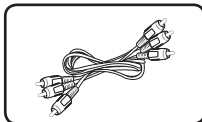

RCA Video/Audio cable  
(1)

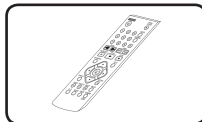



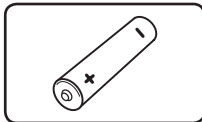



Remote control (1)



Battery (1)

## Playable Discs

	DVD-VIDEO (8 cm / 12 cm disc) Discs such as movies that can be purchased or rented.
	DVD±R (8 cm / 12 cm disc) - Video mode and finalized only - Supports the dual layer disc also
	- DVD±R discs that contain Video, Audio or Photo files.
	DVD-RW (8 cm / 12 cm disc) - VR mode, Video mode and finalized only - DVD-RW discs that contain Video, Audio or Photo files.
	DVD+RW (8 cm / 12 cm disc) - Video mode and finalized only - DVD+RW discs that contain Video, Audio or Photo files.
	Audio CD (8 cm / 12 cm disc)
	CD-R/RW (8 cm / 12 cm disc) - CD-R/RW discs that contain audio titles, Video, Audio or Photo files.

### ! Note

You have to set the disc format option to [Mastered] in order to make the discs compatible with the players when formatting rewritable discs. When setting the option to Live System, you cannot use it on player. (Mastered/Live File System: Disc format system for windows Vista)

## Regional Code

This unit has a regional code printed on the rear of the unit. This unit can play only DVD discs labeled same as the rear of the unit or “ALL”.

## File Compatibility

### Overall

**Available File extensions:** “.avi”, “.mpg”, “.mpeg”, “.mp3”, “.wma”, “.jpg”, “.jpeg”, “.divx”

- The file name is limited to 20 characters.
- Depending on the size and number of the files, it may take several minutes to read the contents on the media.

**Maximum Files/Folder:** Less than 600 (total number of files and folders)

**CD-R/RW, DVD±R/RW Format:** ISO 9660+JOLIET

### Video Files

**Available resolution size:** 720 x 576 (W x H) pixels

**Playable subtitle:** SubRip (.srt/ .txt), SAMI (.smi), SubStation Alpha (.ssa/.txt), MicroDVD (.sub/.txt), SubViewer 2.0 (.sub/.txt), TMPlayer (.txt), DVD Subtitle System (.txt)

**Playable Codec format:** “DIVX3.xx”, “DIVX4.xx”, “DIVX5.xx”, “DIVX6.xx” (Standard playback only), “MP43”, “3IVX”

**Playable Audio format:** “Dolby Digital”, “DTS”, “MP3”, “WMA”

**Sampling frequency:** within 8 to 48 kHz (MP3), within 32 to 48 kHz (WMA)

**Bit rate (MP3/WMA/DivX):** within 8 to 320 kbps (MP3), within 32 to 192 kbps (WMA), less than 4 Mbps (DivX)

#### ! Note

This unit does not support files that are recorded with GMC<sup>\*1</sup> or Qpel<sup>\*2</sup>. Those are video encoding techniques in MPEG4 standard, like DivX have.

\*1 GMC – Global Motion Compensation

\*2 Qpel – Quarter pixel

### Audio Files

**Sampling frequency:** within 8 to 48 kHz (MP3), within 32 to 48 kHz (WMA)

**Bit rate:** within 8 to 320 kbps (MP3), within 32 to 192 kbps (WMA)

### Photo Files

**Photo size:** Less than 2M recommended.

- Progressive and lossless compression photo image files are not supported.

### Notes of USB Device (DP432/DP437 only)

- This unit supports USB device with FAT16 or FAT32 format.
- Do not extract the USB device during operation (play, etc.).
- A USB device which requires additional program installation when you have connected it to a computer, is not supported.
- USB device: USB device that supports USB1.1 and USB2.0.
- Movie, music and photo files can be played. For details of operations on each file, refer to relevant pages.
- Regular back up is recommended to prevent data loss.
- If you use a USB extension cable, USB HUB, USB Multi-reader, or External HDD, the USB device may not be recognized.
- Some USB device may not work with this unit.
- Digital camera and mobile phone are not supported.
- USB Port of the unit cannot be connected to PC. The unit cannot be used as a storage device.

# Remote Control

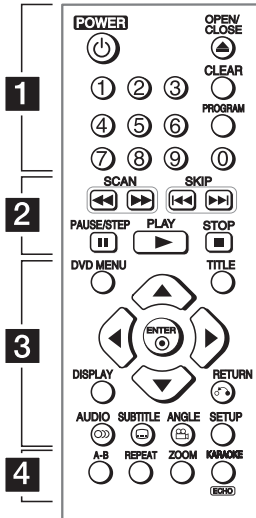

..... **1** .....

- POWER** (⏻): Switches the unit ON or OFF.
- OPEN/CLOSE** (⬆): Opens and closes the disc tray.
- Numerical buttons**: Selects numbered items in a menu.
- CLEAR**: Removes a track number on the Program List.
- PROGRAM**: Enters the program edit mode.

..... **2** .....

- SCAN** (⏮/⏭): Searches backward or forward.
- SKIP** (⏪/⏩): Goes to the next or previous chapter / track / file.
- PAUSE/STEP** (⏸): Pauses playback.
- PLAY** (▶): Starts playback.
- STOP** (■): Stops playback.

..... **3** .....

- DVD MENU**: Accesses or exits the DVD menu.
- TITLE**: Accesses the disc's title menu, if available.
- ▲/▼/◀/▶**: Navigates the menus.
- ENTER** (⊙): Confirms menu selection.
- DISPLAY**: Accesses or exits On-Screen Display.
- RETURN** (↶): Moves backward or exit the menu.
- AUDIO** (🔊): Selects an audio language or audio channel.
- SUBTITLE** (🗣): Selects a subtitle language.
- ANGLE** (📷): Selects a DVD camera angle, if available.
- SETUP**: Accesses or exits the setup menu.

..... **4** .....

- A-B**: Repeats a section.
- REPEAT**: Repeats a chapter, track, title or all.
- ZOOM**: Enlarges video image
- KARAOKE (ECHO)** (DP431/DP437 only): Accesses or exits KARAOKE menu.

## Battery Installation

Remove the battery cover on the rear of the Remote Control, and insert R03 (size AAA) battery with **+** and **-** matched correctly.



## Front Panel

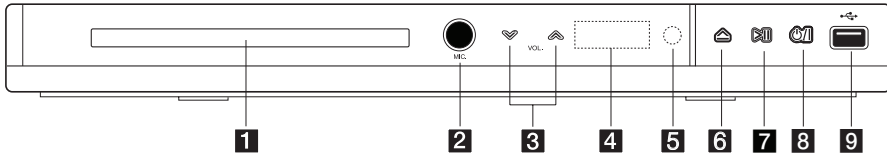

**1** Disc Tray

**2** MIC. (Microphone jack)  
(DP431/DP437 only)

**3** VOL. V/∧ (Volume controller)  
(DP431/DP437 only)

**4** Display window

**5** Remote sensor

**6** △ (Open/Close)

**7** >|| (Play/Pause)

**8** ⏻ / | (Power)

**9** USB Port (DP432/DP437 only)

## Rear Panel

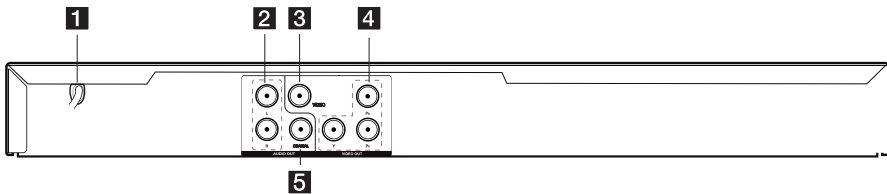

**1** Power Cord

**2** AUDIO OUT (Left/Right)

**3** VIDEO OUT

**4** COMPONENT VIDEO OUT (Y P<sub>B</sub> P<sub>R</sub>)

**5** DIGITAL AUDIO OUT (COAXIAL)

## Connecting to your TV

### Connecting Video / Audio Cable

Connect the VIDEO/AUDIO OUT on the unit to VIDEO/AUDIO IN on TV with A/V cable, such as VIDEO with yellow, AUDIO Left/Right with white/red.

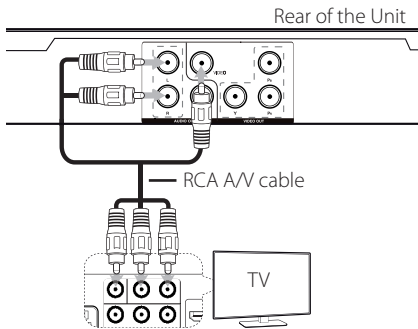

### Connecting Component Video Cable

Connect the COMPONENT VIDEO OUT (Y Pb Pr) jacks on the unit to the corresponding input jacks on the TV using Component video cable, such as Y with green, Pb with blue, and Pr with red.

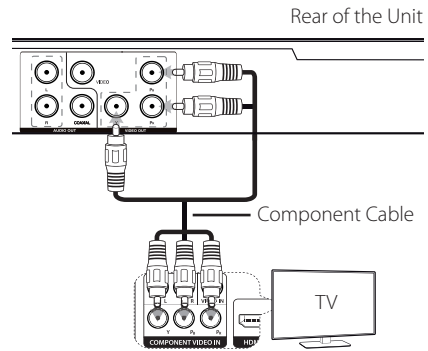

- If your TV accepts progressive format signals, you must use this connection and set [Progressive Scan] to [On] on the setup menu.(See page 12)
- You should still connect the AUDIO cable between the unit and TV.

## Connecting to an Amplifier

### Connecting Audio Cable

Connect the AUDIO OUT (L/R) on the unit to 2CH AUDIO IN on amplifier with Audio cable, such as AUDIO Left/Right with white/red.

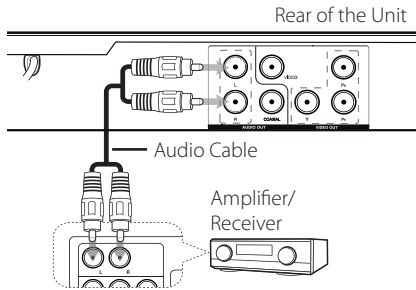

### Connecting COAXIAL (digital audio) Cable

Connect one of the unit's DIGITAL AUDIO OUT (COAXIAL) jacks to the corresponding jack on your amplifier.

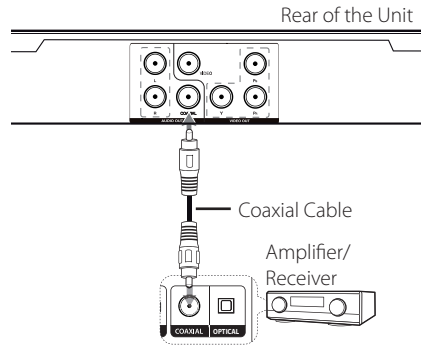

- If your TV is not capable of handling 96 kHz sampling frequency, set the [Sample Freq.] option to [48 kHz] on the setup menu.
- If your TV is not equipped with Dolby Digital and MPEG decoder, set the [Dolby Digital] and [MPEG] options to [PCM] on the setup menu.

#### ! Note

- If the audio format of the digital output does not match the capabilities of your amplifier, the amplifier will produce a strong, distorted sound or no sound at all.
- To see the audio format of the current disc in the on-screen display, press AUDIO.
- This unit does not perform internal (2 channel) decoding of a DTS sound track. To enjoy DTS multi channel surround, you must connect this unit to a DTS compatible amplifier via one of this unit's digital audio outputs.

## Settings

When the unit is turned-on at the first time, you have to select the desired language. (Optional)

### Adjust the Setup Settings

You can change the settings of the unit in the [Setup] menu.

1. Press SETUP.
2. Use ▲/▼ to select the first setup option, and press ► to move to the second level.
3. Use ▲/▼ to select a second setup option, and press ► to move to the third level.
4. Use ▲/▼ to select a desired setting, and press ENTER (⊙) to confirm your selection.

### [LANGUAGE] Menu

#### Menu Language

Select a language for the Setup menu and on-screen display.

#### Disc Audio/Subtitle/Menu

Select a language for the Disc Audio/Subtitle/Menu.

---

**[Original]:** Refers to the original language in which the disc was recorded.

---

**[Other]:** To select another language, press number buttons then ENTER (⊙) to enter the corresponding 4-digit number according to the language code list. (See page 20) If you make a mistake while entering number, press CLEAR to delete numbers then correct it.

---

**[Off]** (for Disc Subtitle): Turn off Subtitle.

---

### [DISPLAY] Menu

#### TV Aspect

Select which screen aspect to use based on the shape of your TV screen.

---

**[4:3]:** Select when a standard 4:3 TV is connected.

---

**[16:9]:** Select when a 16:9 wide TV is connected.

---

#### Display Mode

If you selected 4:3, you'll need to define how you would like widescreen programs and films to be displayed on your TV screen.

---

**[Letterbox]:** This displays a widescreen picture with black bands at the top and bottom of the screen.

---

**[Panscan]:** This fills the entire 4:3 screen, cropping the picture as necessary.

---

#### Progressive Scan (For Component Video connection)

Check whether your TV can accept the progressive signal. If your TV accepts it, you can enjoy accurate color with high quality by selecting [On].

If you set Progressive Scan to [On] in error, you must reset the unit. First, remove the disc in the unit. Next, press and hold STOP for five seconds. The video output will be restored to the standard setting, and a picture will be visible on your TV.

### [AUDIO] Menu

Set the player's Audio options according to various disc output type you use.

#### Dolby Digital / DTS / MPEG

Select the type of digital audio signal to use the DIGITAL AUDIO OUT jack.

---

**[Bitstream]:** Select to connect DIGITAL AUDIO OUT jack to an amplifier with Dolby Digital, DTS or MPEG decoder.

---

**[PCM] (for Dolby Digital / MPEG):** Select to connect DIGITAL AUDIO OUT jack to an amplifier without Dolby Digital or MPEG decoder.

---

**[Off] (for DTS):** Select to connect DIGITAL AUDIO OUT jack to an amplifier without DTS decoder.

---

### Sample Freq. (Frequency)

Selects the sampling frequency of the audio signal between [48 kHz] and [96 kHz].

### DRC (Dynamic Range Control)

Make the sound clear when the volume is turned down (Dolby Digital only). Set to [On] for this effect.

### Vocal (DP430/DP432 only)

Set to [On] only when a multi-channel karaoke DVD is playing. The karaoke channels on the disc mix into normal stereo sound.

### [LOCK] Menu

Firstly, you have to create the 4-digit password on [Area Code] to use the LOCK menu.

#### If you forget your password

First, remove the disc in the unit. Display setup menu then input the 6-digit number "210499". The password is deleted.

### Rating

Select a rating level. The lower the level, the stricter the rating. Select [Unlock] to deactivate the rating.

### Password

Sets or changes the password for lock settings.

### Area Code

To input the standardized area code referring the Area Code List on page 19.

### [OTHERS] Menu

#### B.L.E (Black Level Expansion)

Select On or Off to expand the black level or not.

#### REC Bitrate (DP432/DP437 only)

You can choose a bit rate for USB direct recording. Higher bit rate gives the better sound quality but uses more space on the USB Flash Drive. For USB direct recording, see page 16.

#### Score (DP431/DP437 only)

The score can be displayed after singing a song with microphone. Select [On] in Score to use this function. The score is displayed only when a chapter, title or track is fully finished. Fanfare sounds with the high score.

#### DivX(R) VOD

ABOUT DIVX VIDEO: DivX® is a digital video format created by DivX, LLC, a subsidiary of Rovi Corporation. This is an official DivX Certified® device that plays DivX video. Visit [divx.com](http://divx.com) for more information and software tools to convert your files into DivX videos.

ABOUT DIVX VIDEO-ON-DEMAND: This DivX Certified® device must be registered in order to play purchased DivX Video-on-Demand (VOD) movies. To obtain your registration code, locate the DivX VOD section in your device setup menu. Go to [vod.divx.com](http://vod.divx.com) for more information on how to complete your registration.

---

**[Register]:** Displays the registration code of your unit.

---

**[Deregister]:** Deregister your unit and display the deregister code.

---

## General Playback

### Playing a Disc **DVD** **ACD**

1. Press OPEN/CLOSE (▲), and place a disc on the disc tray.
2. Press OPEN/CLOSE (▲) to close the disc tray. For the most DVD-ROM discs, playback starts automatically.

For the Audio CD, select a track using ▲/▼/◀/▶ and press PLAY (▶) or ENTER (⊙) to play the Track.

### Playing a File **MOVIE** **MUSIC** **PHOTO**

1. Press OPEN/CLOSE (▲) to place a disc on the disc tray, or connect the USB device. (USB: DP432/DP437 only)
2. Select a file using ▲/▼/◀/▶, and press PLAY (▶) or ENTER (⊙) to play the file.

RETURN (↶)	Changes between Disc and USB Device.
TITLE	Changes the mode. (Music → Photo → Movie)

### Playing a Karaoke Disc

(DP431/DP437 only)

1. Insert a Karaoke Disc and connect the microphone to the MIC jack.
2. Select a desired song and press PLAY (▶) to play the file.
3. Press KARAOKE to display karaoke menu. Select an option and the desired mode pressing ▲▼ and ◀▶.

[EFFECT/KEY/ECHO/MIC VOL/MELODY/VOICE]







### ! Notes the Karaoke

- The karaoke feature functions only with karaoke-compatible discs.
- The VOICE and MELODY menus may not be available on some karaoke discs.
- For the microphone sound output through the DIGITAL AUDIO OUT jack, [Dolby Digital] or [MPEG] option must be set to [PCM] on SETUP menu.
- Depending on the disc, a karaoke option may not work.
- According to TV model or brand, karaoke sound from mic can be delayed when TV and the unit are connected directly, so please connect the unit with an amplifier to enjoy karaoke with mic.

### On-Screen Display **DVD** **MOVIE**

You can display and adjust various information and settings about the content.

1. While playback, press DISPLAY to show various playback information.
2. Select an option using ▲/▼.
3. Use ◀/▶ and numerical button to adjust the selected option value.
4. Press DISPLAY to exit the On-Screen display.

 2/6	Current title number/total number of titles
 01/33	Current chapter number/total number of chapters
 C 0:01:44 T 1:51:39	Elapsed playing time Selected total time of current title/file
 1. ENG D/D 3/2.1 CH	Selected audio language or channel
 1. KOR	Selected subtitle
 1/1	Selected angle/total number of angles

## General Operation

To	Do this
<b>Playback</b>	Press PLAY (▶)
<b>Pause</b>	Press PAUSE/STEP (II)
<b>Stop</b>	Press STOP (■)
<b>Skip to the next or previous</b>	Press ◀◀ or ▶▶ during playback
<b>Fast forward or fast reverse</b>	Press ◀◀ or ▶▶ during playback.
<b>Resume playback</b>	<p>Press STOP (■) during playback to save the stopped point.</p> <ul style="list-style-type: none"> <li>Press STOP (■) once: Displayed II■ on the screen (Resume Stop)</li> <li>Press STOP (■) twice: Displayed ■ on the screen (Complete Stop)</li> </ul>
<b>Screen Saver</b>	<p>Leave the unit in Stop mode for about five minutes, then the screen saver appears.</p> <p>If the Screen Saver is displayed for five minutes, the unit automatically turns itself off.</p>
<b>Last Scene Memory</b>	Turn off the unit, then the unit memorize the lastly viewed scene even if disc is inserted again after removal or unit is turned on after off with same disc. (DVD/ Audio CD only)

## Advanced Playback

### Movie **DVD** **MOVIE**

To	Do this
<b>Display disc menu</b>	Press DVD MENU. (DVD Only)
<b>Play repeatedly</b>	<p>Press REPEAT during playback. To select an option to be repeated, Press REPEAT repeatedly.</p> <ul style="list-style-type: none"> <li>DVD: Chapter/ Title/ Off</li> <li>MOVIE: Track/ All/ Off</li> </ul>
<b>Play frame-by-frame</b>	Press PAUSE/STEP (II) while Video file playback and press PAUSE/STEP (II) repeatedly to play Frame-by-Frame playback.
<b>Repeat a specific portion</b>	Press A-B at the beginning of the portion you wish to repeat and again at the end of the portion. To return to normal playback, press A-B to select [Off].
<b>Set the desired starting time of playback</b>	<p>Searches for the starting point of entered time code. Press DISPLAY then select clock icon. Enter a time then press ENTER (⊙).</p> <p>For example, to find a scene at 1 hour, 10 minutes, and 20 seconds, enter "11020" and press ENTER (⊙).</p> <p>If you enter the wrong number, press CLEAR to enter again.</p>
<b>Change the subtitle code page (Video file only)</b>	<p>Press and hold SUBTITLE for 3 seconds during playback. The language code will appear.</p> <p>Press ◀/▶ to select another language code until the subtitle is displayed properly and then press ENTER (⊙)</p>

**Slow down the playing speed (Forward only)** While the playback is paused, press ►► repeatedly to play various speeds of slow motion.

Press PLAY (►) to continue play at normal speed.

**Watch an enlarged video** During playback or pause mode, press ZOOM repeatedly to select zoom mode.

ZOOM: 100% → 200% → 300% → 400% → 100%

▲/▼/◀/▶: Move through the zoomed picture.

## Music **ACD MUSIC**

To	Do this
<b>Play repeatedly</b>	Press REPEAT during playback. To select an item to be repeated, Press REPEAT repeatedly. <ul style="list-style-type: none"> <li>• TRACK/ ALL/ (REPEAT Off)</li> </ul>
<b>Create or delete your own program</b>	Press the PROGRAM to select desired file and then, <b>E</b> mark appears on screen. Using ▲/▼ and ENTER (⊙) to add a music file(s) on the program list, If you add desired music file(s), press PROGRAM to end edit program list. To clear a music file(s) from the program list, select the music file you want to clear then press CLEAR in program edit mode. To clear all music file(s) from the program list, select [Clear All] then press ENTER (⊙) in program edit mode.
<b>Display file information (ID3 TAG).</b>	While playing a MP3 file containing file information, you can display the information by pressing DISPLAY repeatedly. <ul style="list-style-type: none"> <li>• Depending on the MP3 files, information may not be displayed on the screen.</li> </ul>

**Record the Audio CD to USB device** Connect USB Flash Drive to the unit before recording.

(DP432/DP437 only) Insert an Audio CD, and then select a track using ▲/▼, DVD MENU, or numerical buttons.

- For track recording: Press AUDIO(⊙) in play, pause or resume stop mode.
- For all track recording: Press AUDIO(⊙) in complete stop mode.
- For program list recording: In stop mode, press AUDIO(⊙) after selecting a track on the program list.

### ! Note (DP432/DP437 only)

- If you use this function, the "CD\_REC" folder will be created automatically in the USB Flash Driver then the music file(s) is saved in it.
- If you remove USB Flash Drive, turn off or open the unit while recording, it can make a malfunction.
- If the remaining space on the USB Flash Drive is insufficient, the recording is not available. To increase the free space, delete files in it using your PC.
- CD-G disc and Audio CDs encoded in DTS cannot be recorded.
- External HDD, Multi Card reader, Multi Partition USB, Locked device and MP3 player are not supported.
- You can set the recording speed pressing AUDIO during USB direct recording.
  - X1 Track: While normal speed recording, you can listen to the music.
  - X4 Track: While 4X speed recording, you can not listen to the music.
- Recording format: MP3 file
- Encoding Bit rate: 128 Kbps / 160 Kbps / 192 Kbps / 256 Kbps / 320 Kbps



The making of unauthorized copies of copy-protected material, including computer programs, files, broadcasts and sound recordings, may be an infringement of copyrights and constitute a criminal offense. This equipment should not be used for such purposes.

**Be responsible**  
**Respect copyrights**

## Photo **PHOTO**

To	Do this
<b>View photo files as a slide show</b>	Use ▲/▼/◀/▶ to highlight (🖼️) icon then press ENTER (⏻) to start slide show.
<b>Adjust slide show speed</b>	You can change slide show speed using ◀/▶ when (🖼️) icon is highlighted.
<b>Rotate a photo</b>	Use ▲/▼ to rotate the photo in full screen counterclockwise or clockwise while viewing a photo in full screen.
<b>Watch an enlarged Photo</b>	While viewing a photo in full screen, press ZOOM repeatedly to select zoom mode. ZOOM: 100% → 200% → 300% → 400% → 100% ▲/▼/◀/▶: Move through the zoomed photo.
<b>Listen to music during slide show</b>	You can listen to music during slide show, if the disc contain music and photo files together. Use ▲/▼/◀/▶ to highlight (🎵) icon then press ENTER (⏻) to start slide show.

## Troubleshooting

Symptom	Cause	Solution
No power.	The power cord is disconnected.	Plug the power cord into the wall outlet securely.
The power is on, but the unit does not work.	No disc is inserted.	Insert a disc.
The unit does not start playback.	An unplayable disc is inserted.	Insert a playable disc. (Check the disc type and regional code.)
	The rating level is set.	Change the rating level.
The remote control does not work properly.	The remote control is not pointed at the remote sensor on the unit.	Point the remote control at the remote sensor of the unit.
	The remote control is too far from the unit.	Operate the remote control closer to the unit.
Poor picture quality and sound distortion.	Fingerprints and dust are stained on the disc.	Wipe the disc from the center to out with a clean cloth. Do not use strong solvents. (alcohol, benzine, thinner, commercially available cleaners)
No picture.	The TV is not set to receive the signal from the unit.	Select the appropriate video input mode on the TV.
	The video cable is not connected securely.	Connect the video cable securely.
No sound.	The equipment connected with the audio cable is not set to receive the signal from the unit.	Select the correct input mode of the audio amplifier.
	The AUDIO options are set to the wrong position.	Set the AUDIO settings to the correct position.

## Area Code List

Choose an area code from this list.

Area	Code	Area	Code	Area	Code	Area	Code
Afghanistan	AF	Fiji	FJ	Monaco	MC	Singapore	SG
Argentina	AR	Finland	FI	Mongolia	MN	Slovak Republic	SK
Australia	AU	France	FR	Morocco	MA	Slovenia	SI
Austria	AT	Germany	DE	Nepal	NP	South Africa	ZA
Belgium	BE	Great Britain	GB	Netherlands	NL	South Korea	KR
Bhutan	BT	Greece	GR	Antilles	AN	Spain	ES
Bolivia	BO	Greenland	GL	New Zealand	NZ	Sri Lanka	LK
Brazil	BR	Hong Kong	HK	Nigeria	NG	Sweden	SE
Cambodia	KH	Hungary	HU	Norway	NO	Switzerland	CH
Canada	CA	India	IN	Oman	OM	Taiwan	TW
Chile	CL	Indonesia	ID	Pakistan	PK	Thailand	TH
China	CN	Israel	IL	Panama	PA	Turkey	TR
Colombia	CO	Italy	IT	Paraguay	PY	Uganda	UG
Congo	CG	Jamaica	JM	Philippines	PH	Ukraine	UA
Costa Rica	CR	Japan	JP	Poland	PL	United States	US
Croatia	HR	Kenya	KE	Portugal	PT	Uruguay	UY
Czech Republic	CZ	Kuwait	KW	Romania	RO	Uzbekistan	UZ
Denmark	DK	Libya	LY	Russian		Vietnam	VN
Ecuador	EC	Luxembourg	LU	Federation	RU	Zimbabwe	ZW
Egypt	EG	Malaysia	MY	Saudi Arabia	SA		
El Salvador	SV	Maldives	MV	Senegal	SN		
Ethiopia	ET	Mexico	MX				

# Language Code List

Use this list to input your desired language for the following initial settings: [Disc Audio], [Disc Subtitle] and [Disc Menu].

Language	Code	Language	Code	Language	Code	Language	Code
Afar	6565	French	7082	Lithuanian	7684	Sindhi	8368
Afrikaans	6570	Frisian	7089	Macedonian	7775	Singhalese	8373
Albanian	8381	Galician	7176	Malagasy	7771	Slovak	8375
Amharic	6577	Georgian	7565	Malay	7783	Slovenian	8376
Arabic	6582	German	6869	Malayalam	7776	Spanish	6983
Armenian	7289	Greek	6976	Maori	7773	Sudanese	8385
Assamese	6583	Greenlandic	7576	Marathi	7782	Swahili	8387
Aymara	6588	Guarani	7178	Moldavian	7779	Swedish	8386
Azerbaijani	6590	Gujarati	7185	Mongolian	7778	Tagalog	8476
Bashkir	6665	Hausa	7265	Nauru	7865	Tajik	8471
Basque	6985	Hebrew	7387	Nepali	7869	Tamil	8465
Bengali; Bangla	6678	Hindi	7273	Norwegian	7879	Telugu	8469
Bhutani	6890	Hungarian	7285	Oriya	7982	Thai	8472
Bihari	6672	Icelandic	7383	Panjabi	8065	Tonga	8479
Breton	6682	Indonesian	7378	Pashto, Pushto	8083	Turkish	8482
Bulgarian	6671	Interlingua	7365	Persian	7065	Turkmen	8475
Burmese	7789	Irish	7165	Polish	8076	Twi	8487
Byelorussian	6669	Italian	7384	Portuguese	8084	Ukrainian	8575
Chinese	9072	Japanese	7465	Quechua	8185	Urdu	8582
Croatian	7282	Kannada	7578	Rhaeto-Romance	8277	Uzbek	8590
Czech	6783	Kashmiri	7583	Rumanian	8279	Vietnamese	8673
Danish	6865	Kazakh	7575	Russian	8285	Volapük	8679
Dutch	7876	Kirghiz	7589	Samoan	8377	Welsh	6789
English	6978	Korean	7579	Sanskrit	8365	Wolof	8779
Esperanto	6979	Kurdish	7585	Scots Gaelic	7168	Xhosa	8872
Estonian	6984	Laotian	7679	Serbian	8382	Yiddish	7473
Faroese	7079	Latin	7665	Serbo-Croatian	8372	Yoruba	8979
Fiji	7074	Latvian, Lettish	7686	Shona	8378	Zulu	9085
Finnish	7073	Lingala	7678				

## Specifications

<b>Power requirements</b>	AC 110-240 V, 50 / 60Hz
<b>Power consumption</b>	9 W
<b>Dimensions (W x H x D)</b>	(360 x 39.5 x 206) mm
<b>Net Weight (Approx.)</b>	1.4 kg
<b>Operating temperature</b>	0 °C to 40 °C
<b>Operating humidity</b>	5 % to 90 %
<b>Laser</b>	Semiconductor laser
<b>Signal system</b>	NTSC
<b>Bus Power Supply (USB)</b>	DC 5 V  200 mA (DP432/DP437 only)
<b>VIDEO OUT</b>	1.0 V (p-p), 75 Ω, sync negative, RCA jack x 1
<b>COMPONENT VIDEO OUT</b>	(Y) 1.0 V (p-p), 75 Ω, sync negative, RCA jack x 1, (Pb)/(Pr) 0.7 V (p-p), 75 Ω, RCA jack x 2
<b>ANALOG AUDIO OUT</b>	2.0 Vrms (1 kHz, 0 dB), 600 Ω, RCA jack (L, R) x 1
<b>DIGITAL AUDIO OUT (COAXIAL)</b>	0.5 V (p-p), 75 Ω, RCA jack x 1

Design and specifications are subject to change without prior notice.

## Trademarks and Licenses



Manufactured under license from Dolby Laboratories. Dolby and the double-D symbol are trademarks of Dolby Laboratories.



"DVD Logo" is a trademark of DVD Format/Logo Licensing Corporation.



DivX®, DivX Certified® and associated logos are trademarks of Rovi Corporation or its subsidiaries and are used under license.



