



OWNER'S MANUAL

# SMART SOUND BAR

Please read this manual carefully before operating your set and retain it for future reference.

NB3740 (NB3740, S34A1-D)



## Safety Information



**CAUTION:** TO REDUCE THE RISK OF ELECTRIC SHOCK DO NOT REMOVE COVER (OR BACK) NO USER-SERVICEABLE PARTS INSIDE REFER SERVICING TO QUALIFIED SERVICE PERSONNEL.

This lightning flash with arrowhead symbol within an equilateral triangle is intended to alert the user to the presence of uninsulated dangerous voltage within the product's enclosure that may be of sufficient magnitude to constitute a risk of electric shock to persons.



The exclamation point within an equilateral triangle is intended to alert the user to the presence of important operating and maintenance (servicing) instructions in the literature accompanying the product.



**WARNING:** This product contains chemicals known to the State of California to cause cancer and birth defects or other reproductive harm. ***Wash hands after handling.***

**WARNING:** TO PREVENT FIRE OR ELECTRIC SHOCK HAZARD, DO NOT EXPOSE THIS PRODUCT TO RAIN OR MOISTURE.

**CAUTION:** The apparatus shall not be exposed to water (dripping or splashing) and no objects filled with liquids, such as vases, shall be placed on the apparatus.

**WARNING:** Do not install this equipment in a confined space such as a book case or similar unit.

**CAUTION:** Do not block any ventilation openings. Install in accordance with the manufacturer's instructions.

Slots and openings in the cabinet are provided for ventilation and to ensure reliable operation of the product and to protect it from over heating. The openings shall be never be blocked by placing the product on a bed, sofa, rug or other similar surface. This product shall not be placed in a built-in installation such as a bookcase or rack unless proper ventilation is provided or the manufacturer's instruction has been adhered to.

### **CAUTION concerning the Power Cord**

Most appliances recommend they be placed upon a dedicated circuit;

That is, a single outlet circuit which powers only that appliance and has no additional outlets or branch circuits. Check the specification page of this owner's manual to be certain. Do not overload wall outlets. Overloaded wall outlets, loose or damaged wall outlets, extension cords, frayed power cords, or damaged or cracked wire insulation are dangerous. Any of these conditions could result in electric shock or fire. Periodically examine the cord of your appliance, and if its appearance indicates damage or deterioration, unplug it, discontinue use of the appliance, and have the cord replaced with an exact replacement part by an authorized service center. Protect the power cord from physical or mechanical abuse, such as being twisted, kinked, pinched, closed in a door, or walked upon. Pay particular attention to plugs, wall outlets, and the point where the cord exits the appliance. To disconnect power from the mains, pull out the mains cord plug. When installing the product, ensure that the plug is easily accessible.

This device is equipped with a portable battery or accumulator.

**Safety way to remove the battery from the equipment:** Remove the old battery or battery pack, follow the steps in reverse order than the assembly. To prevent contamination of the environment and bring on possible threat to human and animal health, the old battery or the battery put it in the appropriate container at designated collection points. Do not dispose of batteries or battery together with other waste. It is recommended that you use local, free reimbursement systems batteries and accumulators. The battery should not be exposed to excessive heat such as sunshine, fire or the like.

# IMPORTANT SAFETY INSTRUCTIONS

1. Read these instructions.
2. Keep these instructions.
3. Heed all warnings.
4. Follow all instructions.
5. Do not use this apparatus near water.
6. Clean only with dry cloth.
7. Do not block any ventilation openings. Install in accordance with the manufacturer's instructions.
8. Do not install near any heat sources such as radiators, heat registers, stoves, or other apparatus (including amplifiers) that produce heat.
9. Do not defeat the safety purpose of the polarized or grounding-type plug. A polarized plug has two blades with one wider than the other. A grounding type plug has two blades and a third grounding prong. The wide blade or the third prong are provided for your safety. If the provided plug does not fit into your outlet, consult an electrician for replacement of the obsolete outlet.
10. Protect the power cord from being walked on or pinched particularly at plugs, convenience receptacles, and the point where they exit from the apparatus.
11. Only use attachments/accessories specified by the manufacturer.
12. Use only with the cart, stand, tripod, bracket, or table specified by the manufacturer, or sold with the apparatus. When a cart is used, use caution when moving the cart/apparatus combination to avoid injury from tip-over.



13. Unplug this apparatus during lightning storms or when unused for long periods of time.
14. Refer all servicing to qualified service personnel. Servicing is required when the apparatus has been damaged in any way, such as power-supply cord or plug is damaged, liquid has been spilled or objects have fallen into the apparatus, the apparatus has been exposed to rain or moisture, does not operate normally, or has been dropped.

### FCC Compliance Statement

This device complies with part 15 of the FCC rules. Operation is subject to the following two conditions:

- (1) This device may not cause harmful interference, and
- (2) This device must accept any interference received, including interference that may cause undesired operation.

**NOTE:** This equipment has been tested and found to comply with the limits for a Class B digital device, pursuant to Part 15 of the FCC Rules. These limits are designed to provide reasonable protection against harmful interference in a residential installation. This equipment generates, uses, and can radiate radio frequency energy and, if not installed and used in accordance with the instructions, may cause harmful interference to radio communications. However, there is no guarantee that interference will not occur in a particular installation. If this equipment does cause harmful interference to radio or television reception, which can be determined by turning the equipment off and on, the user is encouraged to try to correct the interference by one or more of the following measures:

- Reorient or relocate the receiving antenna.
- Increase the separation between the equipment and receiver.
- Connect the equipment into an outlet on a circuit different from that to which the receiver is connected.
- Consult the dealer or an experienced radio/TV technician for help.

**CAUTION :** Any changes or modifications not expressly approved by the party responsible for compliance could void the user's authority to operate this equipment.

**FCC WARNING:** This equipment may generate or use radio frequency energy. changes or modifications to this equipment may cause harmful interference unless the modifications are expressly approved in the instruction manual. The user could lose the authority to operate this equipment if an unauthorized change or modification is made.

**FCC RF Radiation Exposure Statement :** This equipment complies with FCC radiation exposure limits set forth for an uncontrolled environment. This equipment should be installed and operated with minimum distance 20 cm between the radiator and your body. End users must follow the specific operating instructions for satisfying RF exposure compliance. This transmitter must not be co-located or operating in conjunction with any other antenna or transmitter.

**CAUTION:** Regulations of the FCC and FAA prohibit airborne operation of radio-frequency wireless devices because their signals could interfere with critical aircraft instruments.

### Responsible Party :

LG Electronics USA, Inc. 1000 Sylvan Avenue  
Englewood Cliffs, NJ 07632  
TEL. : +1-800-243-0000

# Table of Contents

## 1 Getting Started

---

- 3 Safety Information
- 8 Introduction
  - 8 – About the "O" symbol display
- 9 Front Panel
- 9 Rear Panel
- 10 Remote Control
- 11 Installing the sound bar
- 11 Mounting the main unit on a wall

## 2 Connecting

---

- 13 Wireless Subwoofer Connection
  - 13 – Pairing wireless subwoofer
- 14 Connecting to Your TV
  - 14 – HDMI Connection
  - 15 – What is SIMPLINK?
  - 15 – ARC (Audio Return Channel) function
  - 15 – Resolution Setting
  - 16 – OPTICAL IN connection
- 17 Connections with external device
  - 17 – OPTICAL IN connection
- 17 Connecting to your Home Network
  - 17 – Wired network connection
  - 18 – Wired network setup
  - 19 – Wireless network connection
  - 20 – Wireless network setup

## 3 System Setting

---

- 23 Initial Setup
- 24 Settings
  - 24 – Adjust the setup settings
  - 25 – [NETWORK] menu
  - 26 – [DISPLAY] menu
  - 27 – [LANGUAGE] menu
  - 27 – [AUDIO] menu
  - 28 – [OTHERS] menu
- 30 Sound Effect

## 4 Operating

---

- 31 Home Menu Display
  - 31 – Using [HOME] menu
  - 31 – Using the SmartShare
- 32 Playing the Linked Devices
  - 32 – Playing a USB device
  - 33 – Playing a file on Android device
  - 34 – Playing a file on a network server
- 34 Using Home Network Server for PC
  - 34 – Installing SmartShare PC Software (DLNA)
    - 35 – Sharing files and folders
    - 35 – System requirements
  - 36 General Playback
    - 36 – Basic operations for video and audio content
    - 36 – Basic operations for photo content
    - 36 – Resume playback
- 37 On-Screen Display
  - 37 – To control video playback
  - 38 – To control photo view
- 39 Advanced Playback
  - 39 – Repeat playback
  - 39 – Repeating a specific portion
  - 39 – Playing from selected time
  - 40 – Selecting a subtitle language
  - 40 – Hearing a different audio
  - 40 – Changing the TV Aspect Ratio
  - 40 – Changing Subtitle Code Page
  - 41 – Changing the Picture Mode
  - 41 – Changing content list view
  - 42 – Selecting a subtitle file
  - 42 – Listening to music during slide show
  - 43 – Setting the [3D] option
- 44 Advanced Features
  - 44 – Wi-Fi Direct™
- 45 LG AV Remote
- 45 Private Sound Mode
- 45 Using Bluetooth technology
  - 46 – Listening to music stored on the Bluetooth devices
- 47 Using the Premium
- 47 Using the LG Smart World
  - 48 – Signing in
  - 48 – Searching online content
- 49 Using the My Apps Menu

## 5 Troubleshooting

---

- 50 Troubleshooting
- 50 – General
- 51 – Network
- 52 – Picture
- 52 – Sound
- 52 – Customer Support
- 52 – Open Source Software Notice

## 6 Appendix

---

- 53 Controlling a TV with the Supplied Remote Control
- 53 – Setting up the remote to control your TV
- 54 Network Software Update
- 54 – Network update notification
- 54 – Software update
- 56 Additional Information
- 56 – File requirement
- 58 – About DLNA
- 58 – Certain system requirements
- 59 Audio Output Specifications
- 60 Trademarks and Licenses
- 62 Specifications
- 63 Maintenance
- 63 – Handling the unit
- 63 Important Information relating to Network Services

Some of the content in this manual may differ from your unit depending on the software of the unit or your service provider.

1

2



3

4

5

6

# Introduction

Term	Symbol	Description
<b>Note</b>		Indicates special notes and operating features.
<b>Caution</b>		Indicates cautions for preventing possible damages from abuse.

## About the “⊘” symbol display

“⊘” may appear on your TV display during operation and indicates that the function explained in this owner’s manual is not available on that specific media.



## Front Panel

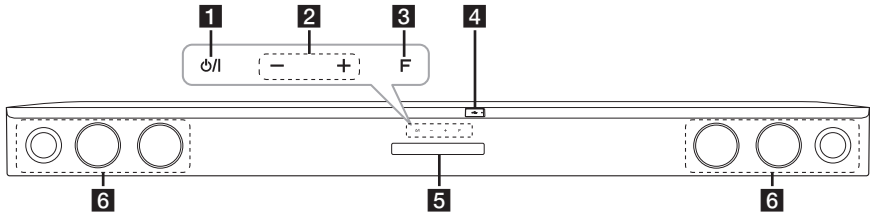

- 1** (Standby/On)
- 2** (Volume)  
Adjusts speaker volume.
- 3** **F** (Function)  
Press it repeatedly to select other function.
- 4** USB Port

### Note

Open USB cover by using your finger to connect USB.

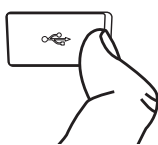

- 5** Display window
- 6** Speakers

### Caution

Precautions in using the touch buttons

- Use the touch buttons with clean and dry hands.
  - In a humid environment, wipe out any moisture on the touch buttons before using.
- Do not press the touch buttons hard to make it work.
  - If you apply too much strength, it can damage the sensor of the touch buttons.
- Touch the button that you want to work in order to operate the function correctly.
- Be careful not to have any conductive material such as metallic object on the touch buttons. It may cause the unit to malfunction.

## Rear Panel

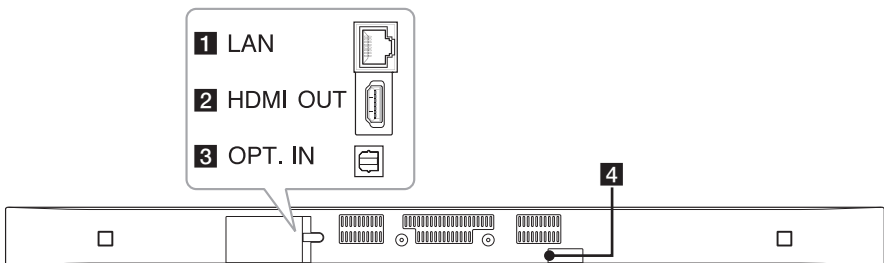

- 1** **LAN** : LAN connector
- 2** **HDMI OUT** : HDMI output
- 3** **OPT. IN** : Optical input
- 4** **DC IN** : DC input

# Remote Control

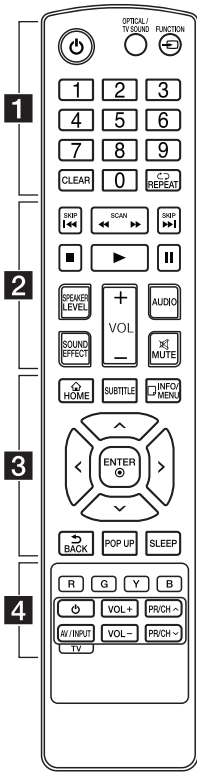

## Battery Installation

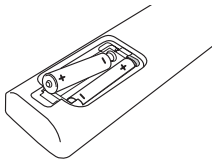

Remove the battery cover on the rear of the Remote Control, and insert two R03 (size AAA) battery with **+** and **-** matched correctly.

..... **1** .....

**⏻ (Power):** Switches the unit ON or OFF.

**OPTICAL/TV SOUND:**

Changes input mode to optical directly.

**FUNCTION (↶):** Changes input mode.

**0-9 numerical buttons:** Selects numbered options in a menu.

**CLEAR:** Removes a mark on the search menu or a number when setting the password.

**REPEAT (↺):** Repeats a desired section or sequence.

..... **2** .....

**⏮/⏭ (SCAN):** Searches backward or forward.

**⏮/⏭ (SKIP):** Goes to the next or previous chapter/title/file.

**■ (Stop):** Stops playback.

**▶ (Play):** Starts playback.

**⏸ (Pause):** Pauses playback.

**SPEAKER LEVEL:** Sets the sound level of desired speaker.

**SOUND EFFECT:** Selects a sound effect mode.

**VOL +/-:** Adjusts speaker volume.

**AUDIO:** Selects an audio language or audio channel.

**MUTE (⏻):** Mute the unit.

..... **3** .....

**HOME (🏠):** Displays or exits the [Home Menu].

**SUBTITLE:** Selects a subtitle language.

**INFO/MENU (ℹ):** Displays or exits On-Screen Display.

Direction buttons (**⬆/⬇/⬅/➡**): Selects an option in the menu.

**ENTER (⊙):** Acknowledges menu selection.

**BACK (⏪):** Exits the menu or resumes playback.

**POP UP:** Displays a pop-up menu, if available.

**SLEEP:** Sets the system to turn off automatically at a specified time.

..... **4** .....

Colored (**R, G, Y, B**) buttons: They are used as shortcut buttons for specific menus.

TV Control Buttons: See page 53.

## Installing the sound bar

You can hear the sound by connecting the unit to the other device : TV, Blu-ray disc player, DVD player, etc.

Place the unit in front of the TV and connect it to the device you want. (Refer to pp. 14 - 17.)

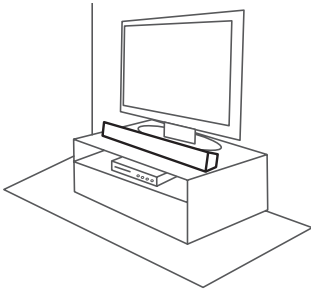

### Caution

For best performance of wireless connection such as Bluetooth or wireless subwoofer, do not install the unit on Metallic furniture because wireless connection communicates through a module positioned on the bottom of the unit.

## Mounting the main unit on a wall

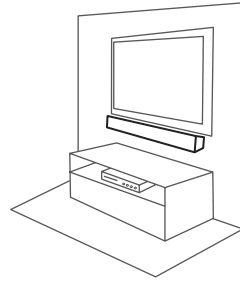

You can mount the main unit on a wall. Prepare screws and bracket.

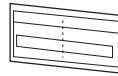

Unit

Wall Mount Bracket  
Installation Template

Wall bracket

1. Match the TV's BOTTOM EDGE of Wall Mount Bracket Installation Template with the bottom of TV and attach to the position.

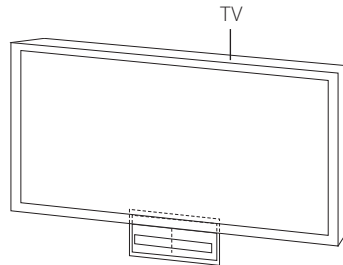

- When you mount it on a wall (concrete), use the wall plugs (Not supplied). You should drill some holes. A guide sheet (Wall Mount Bracket Installation Template) is supplied to drill. Use the sheet to check the point to drill.

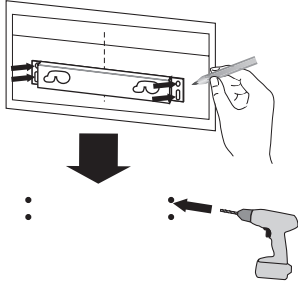

**Note**

Screws and Wall Plugs are not supplied for mounting the unit. We recommend the Hilti (HUD-1 6 x 30) for the mounting.

- Remove the Wall Mount Bracket Installation Template.
- Fix it with screws (not supplied) as shown in the illustration below.

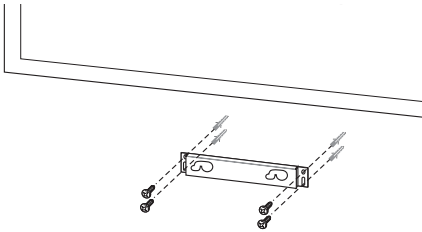

- Hang the main unit onto the bracket as shown below.

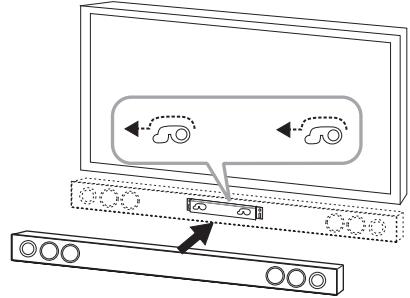

**Caution**

- Do not install this unit upside down. It can damage the parts of this unit or be the cause of personal injury.
- Do not hang onto the installed unit and avoid any impact to the unit.
- Secure the unit firmly to the wall so that it does not fall off. If the unit falls off, it may result in an injury of a person or damage to the product.
- When the unit is installed on a wall, please make sure that a child does not pull any of connecting cables, as it may cause it to fall.

**Note**

Detach the unit from the bracket as shown below.



# Wireless Subwoofer Connection

## Pairing wireless subwoofer

### LED indicator of wireless subwoofer

LED Color	Status
Yellow-green (Blink)	The connection is trying.
Yellow-green	The connection is completed.
Red	The wireless subwoofer is in standby mode or the connection is failed.
Off (No display)	The power cord of wireless subwoofer is disconnected.

### Setting up the wireless subwoofer for the first time

1. Connect the power cord of the Wireless subwoofer to the outlet.
2. Turn on the main unit : The main unit and wireless subwoofer will be automatically connected.

### Manually pairing wireless subwoofer

When your connection is not completed, you can see the red LED or the blinking of yellow-green LED on the wireless subwoofer and the subwoofer does not make sound. To solve the problem, follow the below steps.

1. Adjust volume level of the main unit to minimum.
  - "VOL MIN" appears on the display window.
2. Press and hold **MUTE** (  ) on the remote control for about 3 seconds.
  - "WL RESET" appears on the display window briefly.

3. If the LED of the wireless subwoofer already blinks in yellow-green continually, you can skip this step.

Press and hold **PAIRING** on the back of the wireless subwoofer for more than 5 seconds.

- The LED of the wireless subwoofer lights up alternately in red and yellow-green.
4. Disconnect the power cord of the main unit and the wireless subwoofer.
  5. Connect them again after the LED of the main unit and the wireless subwoofer is fully turned off.

The main unit and the wireless subwoofer will be paired automatically when you turn on the main unit.

- When the connection is completed, you can see the yellow-green LED on the subwoofer.

#### Note

- It takes a few seconds (and may take longer) for the main unit and the subwoofer to communicate with each other and make sounds.
- The closer the main unit and the subwoofer, the better sound quality. It is recommended to install the main unit and the subwoofer as close as possible (within 5 m) and avoid the cases below.
  - There is an obstacle between the main unit and the subwoofer.
  - There is a device using same frequency with this wireless connection such as a medical equipment, a microwave or a wireless LAN device.

## Connecting to Your TV

### HDMI Connection

If you have a HDMI TV or monitor, you can connect it to this unit using a HDMI cable (Type A, High speed HDMI™ cable with Ethernet). Connect the HDMI jack on the unit to the HDMI jack on a HDMI compatible TV or monitor.

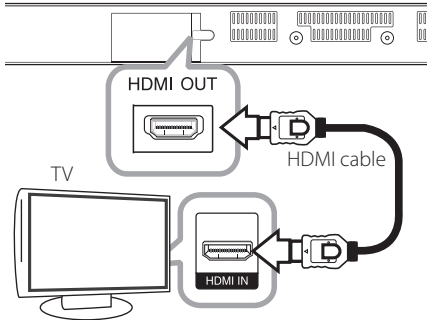

Set the TV's source to HDMI (refer to TV's Owner's manual).

### Additional Information for HDMI

- When you connect a HDMI or DVI compatible device, make sure of the followings:
  - Try switching off the HDMI/DVI device and this unit. Next, switch on the HDMI/DVI device and leave it for around 30 seconds, then switch on this unit.
  - The connected device's video input is set correctly for this unit.
  - The connected device is compatible with 720 x 480p, 1280 x 720p, 1920 x 1080i or 1920 x 1080p video input.
- Not all HDCP-compatible HDMI or DVI devices will work with this unit.
  - The picture will not be displayed properly with non-HDCP device.

### ! Note

- If a connected HDMI device does not accept the audio output of the unit, the HDMI device's audio sound may be distorted or may not output.
- When you use HDMI connection, you can change the resolution for the HDMI output. (Refer to "Resolution Setting" on page 15 )
- Select the type of video output from the HDMI OUT jack using [HDMI Color Setting] option on the [Settings] menu (see page 26).
- Changing the resolution when the connection has already been established may result in malfunctions. To solve the problem, restart the unit.
- When the HDMI connection with HDCP is not verified, TV screen is changed to black screen. In this case, check the HDMI connection, or disconnect the HDMI cable.
- If there are noises or lines on the screen, please check the HDMI cable (length is generally limited to 4.5 m(15 ft.)).

## What is SIMPLINK?



Some functions of this unit are controlled by the TV's remote control when this unit and LG TV's with SIMPLINK are connected through HDMI connection.

Controllable functions by LG TV's remote control :  
Power on/off, volume up/down, etc.

Refer to the TV owner's manual for the details of SIMPLINK function.

LG TV's with SIMPLINK function has the logo as shown above.

### ! Note

Depending on the state of the unit, some SIMPLINK operation may differ from your purpose or not work.

## ARC (Audio Return Channel) function

The ARC function enables an HDMI capable TV to send the audio stream to HDMI OUT of the unit.

To use this function:

- Your TV must support the HDMI-CEC and ARC function and the HDMI-CEC and ARC must be set to On.
- The setting method of HDMI-CEC and ARC may differ depending on the TV. For details about ARC function, refer to your TV manual.
- You must use the HDMI cable (Type A, High Speed HDMI™ cable with Ethernet).
- You must connect the HDMI OUT on the unit with HDMI IN of the TV that supports ARC function using an HDMI cable.
- You can connect only one Sound bar to TV compatible with ARC.

### ! Note

To active [SIMPLINK/ARC] function, set this option to [On]. (page 29)

## Resolution Setting

The unit provides several output resolutions for HDMI OUT jack. You can change the resolution using [Settings] menu.

1. Press **HOME** (🏠).
2. Use **</>** to select the [Settings] and press **ENTER** (⊙). The [Settings] menu appears.
3. Use **^/v** to select [DISPLAY] option then press **>** to move to the second level.
4. Use **^/v** to select the [Resolution] option then press **ENTER** (⊙) to move to the third level.

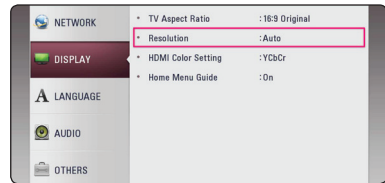

5. Use **^/v** to select the desired resolution then press **ENTER** (⊙) to confirm your selection.

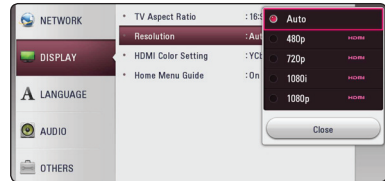

### ! Note

- If your TV does not accept the resolution you have set on the unit, you can set resolution to 480p as follows:
  1. Press **HOME** (🏠) to disappear the HOME menu.
  2. Press **■** (Stop) for more than 5 seconds.
- If you select a resolution manually and then connect the HDMI jack to TV and your TV does not accept it, the resolution setting is set to [Auto].
- If you select a resolution that your TV does not accept, the warning message will appear. After resolution change, if you cannot see the screen, please wait 20 seconds and the resolution will automatically revert back to the previous resolution.

## OPTICAL IN connection

You can enjoy the sound from your TV with a optical digital audio connection.

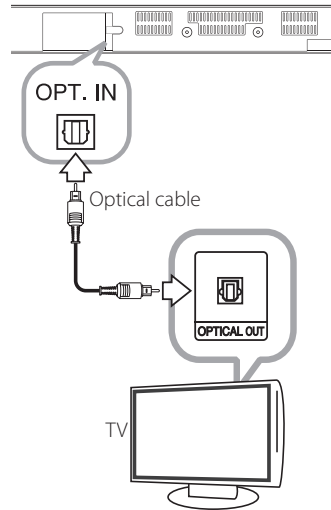

Connect the optical output jack of your TV into the OPT. IN jack on the unit. And then select the [OPTICAL] option by pressing **FUNCTION** (⊖). Or press **OPTICAL/TV SOUND** to select directly.



## Connections with external device

### OPTICAL IN connection

You can enjoy the sound from your component with a digital optical connection through the speakers of this system.

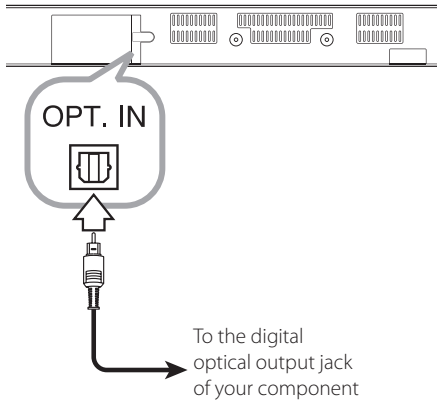

Connect the optical output jack of your component into the OPT. IN jack on the unit. And then select the [OPTICAL] option by pressing **FUNCTION** (↔). Or press **OPTICAL/TV SOUND** to select directly.

You can also use the **F** (Function) button on the front panel to select the input mode.

## Connecting to your Home Network

This unit can be connected to a local area network (LAN) via the LAN port on the rear panel or the internal wireless module.

By connecting the unit to a broadband home network, you have access to services such as software updates and online content services.

### Wired network connection

Using a wired network provides the best performance, because the attached devices connect directly to the network and are not subject to radio frequency interference.

Please refer to the documentation for your network device for further instructions.

Connect the unit's LAN port to the corresponding port on your Modem or Router using a commercially available LAN or Ethernet cable.

#### ! Note

- When plugging or unplugging the LAN cable, hold the plug portion of the cable. When unplugging, do not pull on the LAN cable but unplug while pressing down on the lock.
- Do not connect a modular phone cable to the LAN port.
- Since there are various connection configurations, please follow the specifications of your telecommunication carrier or internet service provider.
- If you want to access content from DLNA servers, this unit must be connected to the same local area network through a router.
- To set your PC as a DLNA server, install SmartShare PC Software on your PC. (page 34)

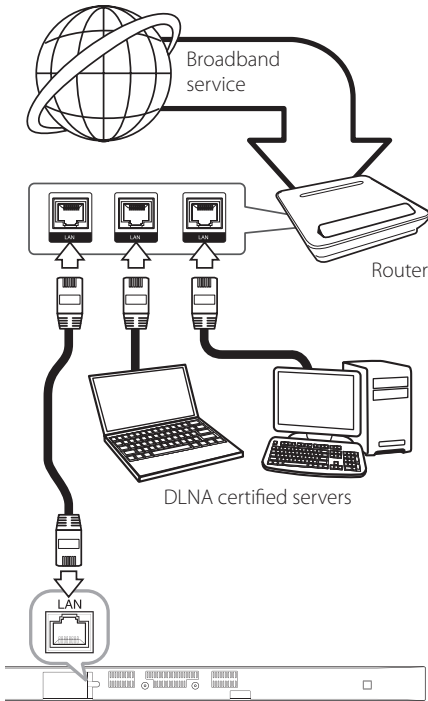

### Wired network setup

If there is a DHCP server on the local area network (LAN) via wired connection, this unit will automatically be allocated an IP address. After making the physical connection, a small number of home networks may require the unit's network setting to be adjusted. Adjust the [NETWORK] setting as follow.

#### Preparation

Before setting the wired network, you need to connect the broadband internet to your home network.

1. Select [Connection Setting] option in the [Settings] menu then press **ENTER** (⊙).

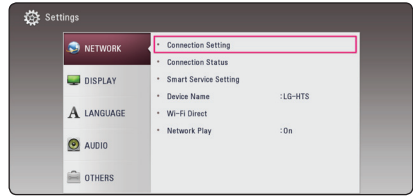

2. Read the preparations for the network settings and then press **ENTER** (⊙) while [Start] is highlighted.

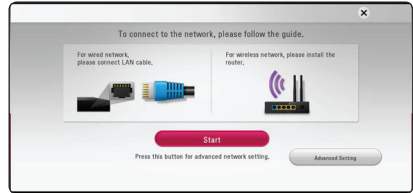

Network will automatically be connected to the unit.



### Advanced Setting

If you want to set the network settings manually, use **▲/▼** to select [Advanced Setting] on the [Network Setting] menu and press **ENTER** (⊙).

1. Use **▲/▼** to select [Wired] and press **ENTER** (⊙).

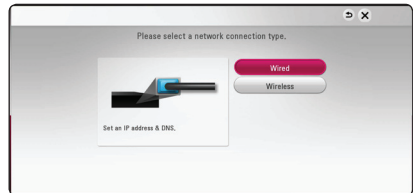

- Use **^/V/</>** to select the IP mode between [Dynamic] and [Static]. Normally, select [Dynamic] to allocate an IP address automatically.

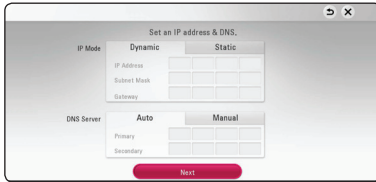

### Note

If there is no DHCP server on the network and you want to set the IP address manually, select [Static] then set [IP Address], [Subnet Mask], [Gateway] and [DNS Server] using **^/V/</>** and numerical buttons. If you make a mistake while entering a number, press **CLEAR** to clear the highlighted part.

- Select [Next] and press **ENTER** (⊙) to apply network settings.

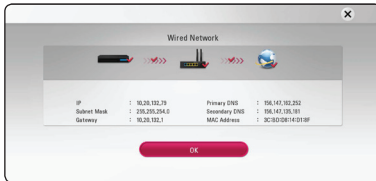

Network connection status is displayed on the screen.

- Press **ENTER** (⊙) while [OK] is highlighted to finish the wired network settings.

## Wireless network connection

Another connection option is to use an Access Point or a wireless router. The network configuration and connection method may vary depending on the equipment in use and the network environment.

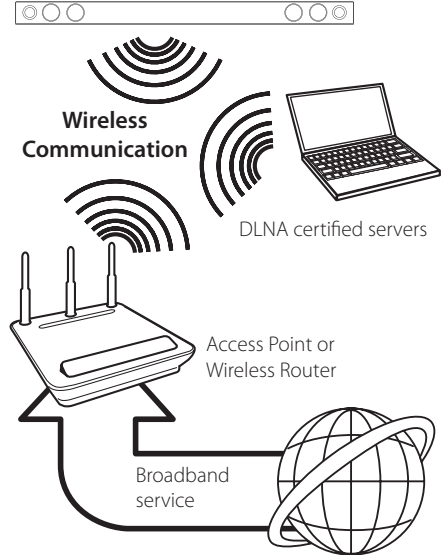

Refer to the setup instructions supplied with your access point or wireless router for detailed connection steps and network settings.

For best performance, a direct wired connection from this unit to your home network's router or cable/DSL modem is always the best option. If you choose to use the wireless option, please note that performance can sometimes be affected by other electronic devices in the home.

## Wireless network setup

For the wireless network connection, the unit needs to be set up for network communication. This adjustment can be done from the [Settings] menu. Adjust the [NETWORK] setting as follow. Setting up the access point or the wireless router is required before connecting the unit to the network.

### Preparation

Before setting the wireless network, you need to:

- connect the broadband internet to the wireless home network.
- set the access point or wireless router.
- note the SSID and security code of the network.

1. Select [Connection Setting] option in the [Settings] menu then press **ENTER** (⊙).
2. Read the preparations for the network settings and then press **ENTER** (⊙) while [Start] is highlighted.

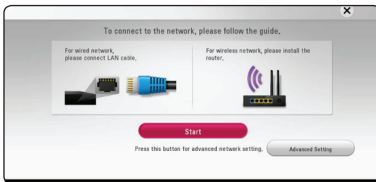

If wired network is not connected to the unit, all available networks are displayed on the screen.

3. Use **▲/▼** to select a desired SSID of wireless network and press **ENTER** (⊙).

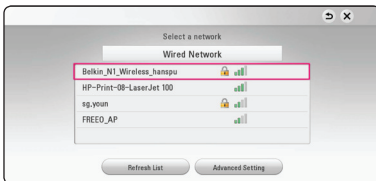

If you have security on your access point, you need to input the security code as necessary.

### Note

If you use other characters than the english alphabet or digits for the SSID name of your access point or wireless router, it may be displayed differently.

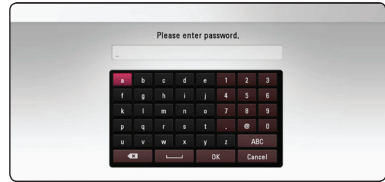

### Note

- WEP security mode generally have 4 keys available on an access point setting. If your access point or wireless router use WEP security, enter the security code of the key "No.1" to connect on your home network.
  - An Access Point is a device that allows you to connect to your home network wirelessly.
4. Use **▲/▼/◀/▶** to select the IP mode between [Dynamic] and [Static]. Normally, select [Dynamic] to allocate an IP address automatically.

### Note

If there is no DHCP server on the network and you want to set the IP address manually, select [Static] then set [IP Address], [Subnet Mask], [Gateway] and [DNS Server] using **▲/▼/◀/▶** and numerical buttons. If you make a mistake while entering a number, press **CLEAR** to clear the highlighted part.

5. Select [Next] and press **ENTER** (⊙) to apply network settings.



Network connection status is displayed on the screen.

6. Select [OK] and press **ENTER** (⊙) to complete the network connection.

## Advanced Setting

If you want to set the network settings manually, use **▲/▼** to select [Advanced Setting] on the [Network Setting] menu and press **ENTER** (⊙).

1. Use **▲/▼** to select [Wireless] and press **ENTER** (⊙).



**[AP List]** - Scans all available access points or wireless routers within range and display them as a list.

**[Network name (SSID)]** – Your access point may not be broadcasting its network name (SSID). Check your access point settings through your computer and either set your access point to broadcast SSID, or manually enter the network name in [Network name(SSID)].

**[PBC]** – If your access point or wireless router that supports the PBC (Push Button Configuration) method, select this option and press the Push Button on your access point within 120 counts. You do not need to know the network name (SSID) and security code of your access point.

**[PIN]** – If your access point supports the PIN Code configuration method based on WPS(Wi-Fi Protected Setup), select this option and note the code number on the screen. And then, enter the PIN number on a setting menu of your access point to connect. Refer to the documentation for your network device.

2. Follow the instructions of each connection method on the screen.



### Note

To use PBC and PIN network connection, security mode of your access point must be set to OPEN or AES.

## Notes on network connection

- Many network connection problems during set up can often be fixed by re-setting the router or modem. After connecting the unit to the home network, quickly power off and/or disconnect the power cable of the home network router or cable modem. Then power on and/or connect the power cable again.
- Depending on the internet service provider (ISP), the number of devices that can receive internet service may be limited by the applicable terms of service. For details, contact your ISP.
- Our company is not responsible for any malfunction of the unit and/or the internet connection feature due to communication errors/malfunctions associated with your broadband internet connection, or other connected equipment.
- Some internet content may require a higher bandwidth connection.
- Even if the unit is properly connected and configured, some internet content may not operate properly because of internet congestion, the quality or bandwidth of your internet service, or problems at the provider of the content.
- Some internet connection operations may not be possible due to certain restrictions set by the Internet service provider (ISP) supplying your broadband Internet connection.
- Any fees charged by an ISP including, without limitation, connection charges are your responsibility.
- A 10 Base-T or 100 Base-TX LAN port is required for wired connection to this unit. If your internet service does not allow for such a connection, you will not be able to connect the unit.
- You must use a Router to use xDSL service.
- A DSL modem is required to use DSL service and a cable modem is required to use cable modem service. Depending on the access method of and subscriber agreement with your ISP, you may not be able to use the internet connection feature contained in this unit or you may be limited to the number of devices you can connect at the same time. (If your ISP limits subscription to one device, this unit may not be allowed to connect when a PC is already connected.)

- The use of a “Router” may not be allowed or its usage may be limited depending on the policies and restrictions of your ISP. For details, contact your ISP directly.
- The wireless network operate at 2.4 GHz radio frequencies that are also used by other household devices such as cordless telephone, **Bluetooth®** devices, microwave oven, and can be affected by interference from them.
- Turn off all unused network equipment in your local home network. Some devices may generate network traffic.
- For better reception, place the unit from the access point as close as possible.
- In some instances, placing the access point or wireless router at least 0.45 m (1.5 ft.) above the floor may improve the reception.
- The reception quality over wireless depends on many factors such as type of the access point, distance between the unit and access point, and the location of the unit.
- Set your access point or wireless router to Infrastructure mode. Ad-hoc mode is not supported.

## Initial Setup

When you turn on the unit for the first time, the initial setup wizard appears on the screen. Set the display language and network settings on the initial setup wizard.

1. Press **⏻** (Power).

The initial setup wizard appears on the screen.

2. Use **▲/▼/◀/▶** to select a display language and press **ENTER** (⊙).



3. Read and prepare the preparations for the network settings and then press **ENTER** (⊙) while [Start] is highlighted.

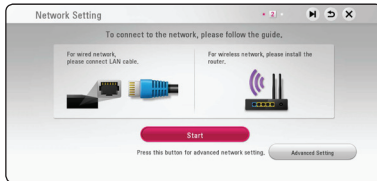

If wired network is connected, the network connection setting will automatically be finished.

4. All available networks are displayed on the screen. Use **▲/▼** to select [Wired Network] or desired SSID of wireless network and press **ENTER** (⊙).

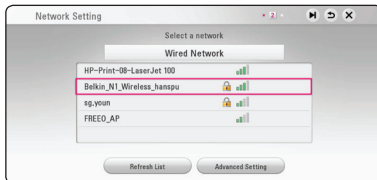

If you have security on your access point, you need to input the security code as necessary.

5. Use **▲/▼/◀/▶** to select the IP mode between [Dynamic] and [Static]. Normally, select [Dynamic] to allocate an IP address automatically.

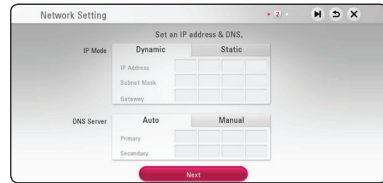

6. Select [Next] and press **ENTER** (⊙) to apply network settings.

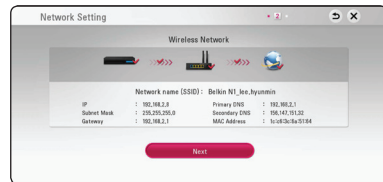

Network connection status is displayed on the screen.

For details on network settings, refer to “Connecting to your Home Network” on page 17.

7. Select [Next] and press **ENTER** (⊙).
8. You can listen to TV sound through HTS Speaker automatically when TV is turned on. TV and HTS should be connected with optical cable. Press **▲** to move and press **◀/▶** to select [On] or [Off]. Select [Next] and press **ENTER** (⊙).



- Check all the settings that you have set in the previous steps.



Press **ENTER** (⊙) while [Finish] is highlighted to finish the initial setup settings. If there is any settings to be changed, use **▲/▼/◀/▶** to select **↩** and press **ENTER** (⊙).

- Displays private sound mode guide. Press **ENTER** (⊙).

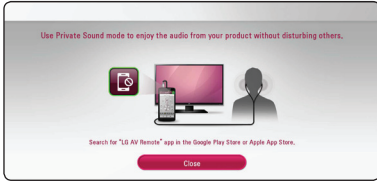

## Settings

### Adjust the setup settings

You can change the settings of the unit in the [Settings] menu.

- Press **HOME** (🏠).



- Use **◀/▶** to select the [Settings] and press **ENTER** (⊙). The [Settings] menu appears.

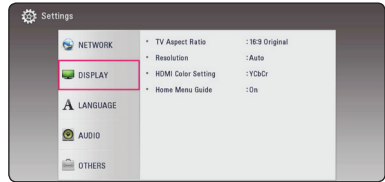

- Use **▲/▼** to select the first setup option, and press **>** to move to the second level.



- Use **▲/▼** to select a second setup option, and press **ENTER** (⊙) to move to the third level.

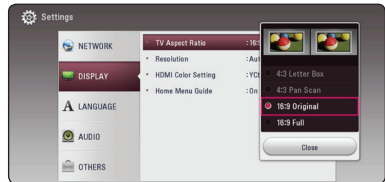

- Use **▲/▼** to select a desired setting, and press **ENTER** (⊙) to confirm your selection.



## [NETWORK] menu

The [NETWORK] settings are needed to use the software update and online content services.

### Connection Setting

If your home network environment is ready to connect, the unit needs to be set up via wireless or wired connection for network communication. (See "Connecting to your Home Network" on page 17.)

### Connection Status

If you want to check the network status on this unit, select the [Connection Status] options and press **ENTER** (⊙) to check whether a connection to the network and the internet have been established.

### Smart Service Setting

#### [Country Setting]

Select your area for displaying proper online content service.

#### [Initialize]

- [Deactivate Netflix]  
Deactivates your unit. To activate the Netflix again, contact to the service provider.
- [Netflix ESN]  
Display its unique Netflix ESN (Electronic Serial Number) that allows you to use the Netflix streaming.
- [Deactivate VUDU]  
Deactivates your unit. To activate the VUDU again, contact to the service provider.

### Device Name

You can make a network name using virtual keyboard. This unit will be recognised by the name you are entering on your home network.

### Wi-Fi Direct

This unit is a Wi-Fi Direct™ certified device. Wi-Fi Direct™ is the technology that enables devices to connect each other without connecting to an Access point or a router. Set this option to [On] for activating the Wi-Fi Direct™ mode. Refer to page 44 for the device connection.

### Network Play

This function allows you to control the playback of media streamed from DLNA media server by a DLNA certified smartphone. Most DLNA certified smartphone has a function to control the playback media on your home network. Set this option to [On] for allowing your smartphone to control this unit. Refer to instructions of your DLNA certified smartphone or the application for more detailed information.

#### ! Note

- This unit and the DLNA Certified Smartphone must be connected to the same network.
- To use the [Network Play] function using a DLNA certified smartphone, press **HOME** (🏠) to display the home menu before connecting to this unit.
- While controlling the unit using the [Network Play] function, the remote control may not work.
- Available file formats described on page 56 are not always supported on [Network Play] function.

## [DISPLAY] menu

### TV Aspect Ratio

Select a TV aspect ratio option according to your TV type.

---

#### [4:3 Letter Box]

Select when a standard 4:3 TV is connected. Displays theatrical images with masking bars above and below the picture.

---

#### [4:3 Pan Scan]

Select when a standard 4:3 TV is connected. Displays pictures cropped to fill your TV screen. Both sides of the picture are cut off.

---

#### [16:9 Original]

Select when a 16:9 wide TV is connected. The 4:3 picture is displayed with an original 4:3 aspect ratio, with black bars appearing at the left and right sides.

---

#### [16:9 Full]

Select when a 16:9 wide TV is connected. The 4:3 picture is adjusted horizontally (in a linear proportion) to fill the entire screen.



#### Note

You cannot select [4:3 Letter Box] and [4:3 Pan Scan] option when the resolution is set to higher than 720p.

### Resolution

Sets the output resolution of the HDMI video signal. Refer to page 15 for details about the resolution setting.

---

#### [Auto]

If the HDMI OUT jack is connected to TVs providing display information (EDID), automatically selects the resolution best suited to the connected TV.

---

#### [480p]

Outputs 480 lines of progressive video.

---

#### [720p]

Outputs 720 lines of progressive video.

---

#### [1080i]

Outputs 1080 lines of interlaced video.

---

#### [1080p]

Outputs 1080 lines of progressive video.

---

### HDMI Color Setting

Select the type of output from the HDMI OUT jack. For this setting, please refer to the manuals of your display device.

---

#### [YCbCr]

Select when connecting to a HDMI display device.

---

#### [RGB]

Select when connecting to a DVI display device.

---

### Home Menu Guide

This function allows you to display or delete the guide bubble on the [HOME] menu. Set this option to [On] for displaying guide.

## [LANGUAGE] menu

### Display Menu

Select a language for the [Settings] menu and on-screen display.

## [AUDIO] menu

Each file has a variety of audio output options. Set the unit's Audio options according to the type of audio system you use.

### ! Note

Since many factors affect the type of audio output, see "Audio Output Specifications" on page 59 for details.

## Digital Output

### [Auto]

Select if you connect this unit's HDMI OUT jack to a device with LPCM, Dolby Digital, Dolby Digital Plus, Dolby TrueHD, DTS, DTS-HD decoder or digital decoder.

### [PCM]

Select if you connect this unit's HDMI OUT jack to a device with digital decoder.

### [DTS Re-Encode]

Select if you connect this unit's HDMI OUT jack to a device with DTS decoder.

### ! Note

- When [Digital Output] option is set to [Auto], the audio may output as bitstream. If the bitstream information is not detected from HDMI device with EDID, the audio may output as PCM.
- This setting is not available on the input signal from an external device.

## DRC (Dynamic Range Control)

This function allows you to listen to a movie at a lower volume without losing clarity of sound.

### [Auto]

The dynamic range of the Dolby Digital and Dolby Digital Plus are operated as same as the [On] mode.

### [On]

Compress the dynamic range of the Dolby Digital, Dolby Digital Plus audio output.

### [Off]

Turns off this function.

## HD AV Sync

Sometimes Digital TV encounters a delay between picture and sound. If this happens you can compensate by setting a delay on the sound so that it effectively 'waits' for the picture to arrive: this is called HD AV Sync. Use <> to scroll up and down through the delay amount, which you can set at anything between 0 and 300 ms.

## [OTHERS] menu

### DivX® VOD

ABOUT DIVX VIDEO: DivX® is a digital video format created by DivX, LLC, a subsidiary of Rovi Corporation. This is an official DivX Certified® device that has passed rigorous testing to verify that it plays DivX video. Visit [divx.com](http://divx.com) for more information and software tools to convert your files into DivX videos.

ABOUT DIVX VIDEO-ON-DEMAND: This DivX Certified® device must be registered in order to play purchased DivX Video-on-Demand (VOD) movies. To obtain your registration code, locate the DivX VOD section in your device setup menu. Go to [vod.divx.com](http://vod.divx.com) for more information on how to complete your registration.

#### [Register]

Displays the registration code of your unit.

#### [Deregister]

Deactivate your unit and display the deactivation code.

#### ! Note

All the downloaded videos from DivX® VOD with this player's registration code can only be played on this unit.

## Quick Start

This player can stay in standby mode with low power consumption, so that the player can instantly boot without delay when you turn on this unit. Set this option to [On] for activating [Quick Start] function.

#### ! Note

- If [Quick Start] option is set to [On] and an AC power is accidentally re-connected to the player by power failure etc., the player automatically boots itself to be the standby status. Before operating the player, wait for a while until the player is in standby status.
- When [Quick Start] is set to [On], power consumption will be higher than when [Quick Start] is set to [Off].

## Auto Power Off

The screen saver appears when you leave the unit in Stop mode for about five minutes. If you set this option to [On], the unit automatically turns off within 15 minutes since the Screen Saver is displayed. Set this option to [Off] to leave the screen saver until the unit is operated by the user.

#### ! Note

When you set [Auto Power Off] function in setting menu on, this unit will be off itself to save electronic consumption in the case main unit is not connected to external device and is not used for 20 minutes.

## TV Sound Connecting

You can listen to TV sound through this unit's speaker automatically when TV is turned on. TV and this unit should be connected with optical cable.

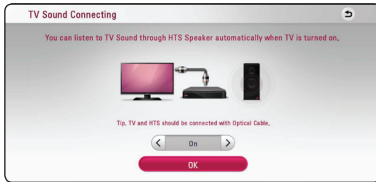

Press **▲** to move and press **</>** to select [On] or [Off]. Select [OK] and press **ENTER** (⊙).

## Initialize

### [Factory Set]

You can reset the unit to its original factory settings.

### ! Note

If you reset the unit to its original factory settings using [Factory Set] option, you have to set all the activation for the online services and network settings again.

## Software

### [Information]

Displays the current software version.

### [Update]

You can update the software by connecting the unit directly to the software update server (page 54).

## SIMPLINK/ARC

- The SIMPLINK function allows you to control this unit with LG TV's remote control.
- The ARC function enables an HDMI capable TV to send the audio stream to HDMI OUT of this player.

Set this option to [On] for activating [SIMPLINK/ARC] function. (page 15)

## Closed Caption

Closed caption (CC) is the process of displaying text on a screen to provide additional or interpretive information for the hearing impaired.

This function allows you to adjust various settings of closed caption.

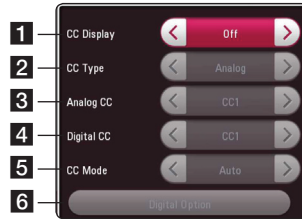

### 1 [CC Display]

Turns on or off this function.

### [CC Type]

Selects the closed caption type between [Analog] and [Digital].

- 2 [Analog] : Select this when you play some video files that support [Analog] CC type. [Digital] : Select this when you play Online content or some video files that support [Digital] CC type.

### [Analog CC]

(When [CC Type] is selected to [Analog])

- 3 Displays the audio portion of a movie as text on the screen. CC1 is the most common mode in use.

### [Digital CC]

(When [CC Type] is selected to [Digital])

- 4 The language option of the online content can be selected here. (but language option will be supported fully or partially according to contents)

### [CC Mode]

(When [CC Type] is selected to [Digital])

- 5 Selects the closed caption mode between [Custom] and [Auto].

### [Digital Option]

(When [CC Mode] is selected to [Custom])

- 6 You can adjust detail settings of closed caption.

### Adjusting the [Digital Option]

When [CC Mode] is selected to [Custom], you can adjust detail settings of closed caption.

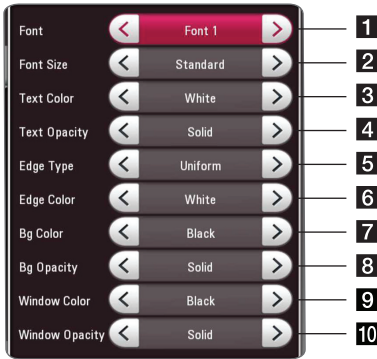

Selects a typeface for the text.

- 1 Font1 : Default / Font2 : Courier  
Font3 : TimesNewRoman / Font4 : Helvetica  
Font5 : Arial / Font6 : Casual  
Font7 : Cursive / Font8 : SmallCapital

- 2 Selects the font size.
- 3 Selects a color for the text.
- 4 Adjusts the opacity for the text color.
- 5 Selects an edge type.
- 6 Selects a color for the edges.
- 7 Selects a background color.
- 8 Adjusts the opacity for the background color.
- 9 Selects a window color.
- 10 Adjusts the opacity for the window color.

#### ! Note

- On description page, a CC logo will appear if closed captioning is supported.
- If online content include closed caption of its own, this setting may not work.
- Online content supports closed caption function, if you want to use closed caption, go to [Settings] > [OTHERS] > [Closed Caption].

## Sound Effect

You can select a sound mode that suits you and the content you are playing. Press **SOUND EFFECT** repeatedly until the desired mode appears on the front panel display or the TV screen. The displayed items for the equalizer maybe different depending on sound sources and effects.

**[Music]:** You can enjoy comfortable and natural sound.

**[Standard]:** Software with multichannel surround audio signals is played according to the way it was recorded.

**[Bass]:** Reinforce the bass sound effect from front left and right speaker and subwoofer.

**[Loudness]:** Improves bass and treble sound.

**[User EQ]:** You can adjust the sound by raising or lowering the level of specific frequency.

### Setting the [User EQ]

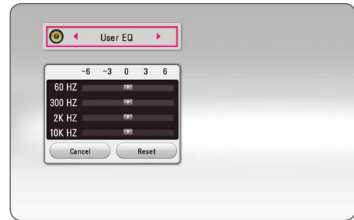

1. Use  $\wedge/\vee$  to select the desired frequency.
2. Use  $</>$  to select the desired level.

Select [Cancel] option then press **ENTER** (Ⓞ) to cancel the setting.

Select [Reset] option then press **ENTER** (Ⓞ) to reset the all adjustments.

# Home Menu Display

## Using [HOME] menu

The home menu appears when you press **HOME** (🏠). Use **▲/▼/◀/▶** to select a category and press **ENTER** (⊙).

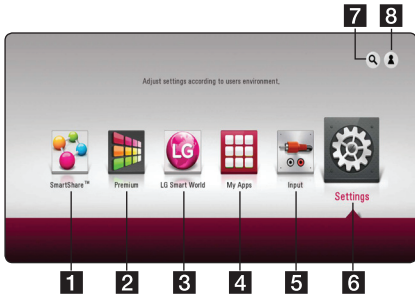

**Note**

Depending on the region, the [LG Smart World], [My Apps], [Q] and [👤] may not be available.

- 1** [SmartShare] - Displays SmartShare menu.
- 2** [Premium] - Displays the Premium home screen. (page 47)
- 3** [LG Smart World] - Displays LG Apps titles provided to the unit. (page 47)
- 4** [My Apps] - Displays the [My Apps] screen. (page 49)
- 5** [Input] - Changes input mode.
- 6** [Settings] - Adjusts the system settings.
- 7** [Q] - Searches for desired LG Apps and other content.
- 8** [👤] - Displays login menu.

## Using the SmartShare

You can play video, photo and audio content on the unit by connecting a USB device and Android device (MTP) or using home network (DLNA).

1. Press **HOME** (🏠) to display the home menu.
2. Select [SmartShare] and press **ENTER** (⊙).

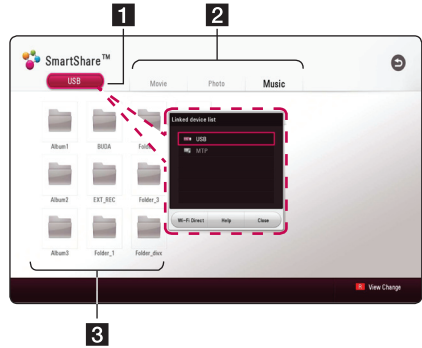

- 1** Displays all linked devices.
- 2** Displays video, photo or audio content.
- 3** Displays the file or folder on linked device.

# Playing the Linked Devices

## Playing a USB device

### MOVIE MUSIC PHOTO

This unit can play video, audio and photo files contained on a USB device.

1. Connect a USB device on the unit.

#### ! Note

You can connect a USB device more easily by using USB gender changer supplied as an accessory.

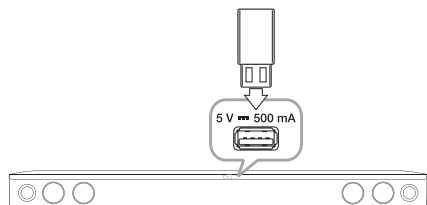

When you connect the USB device on the HOME menu, the unit plays an audio file contained in the USB storage device automatically. If the USB storage device is containing various types of files, a menu for the file type selection will appear.

File loading may take few minutes depending on the number of content stored in the USB storage device. Press **ENTER** (⊙) while [Cancel] is selected to stop loading.

2. Press **HOME** (🏠).
3. Select [SmartShare] and press **ENTER** (⊙).

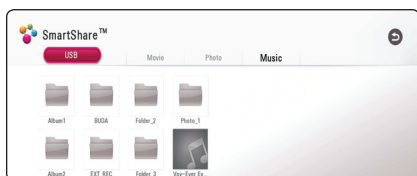

4. Select the desired linked device in the category.
5. Select [Movie], [Photo] or [Music].
6. Select a file using **▲/▼/◀/▶**, and press **▶**(Play) or **ENTER** (⊙) to play the file.

## Notes on USB device

- This unit supports USB flash drive/external HDD formatted in FAT32 and NTFS when accessing files (music, photo, movie).
- This unit can support up to 4 partitions of the USB device.
- Do not extract the USB device during operation (play, etc.).
- A USB device which requires additional program installation when you have connected it to a computer, is not supported.
- USB device: USB device that supports USB1.1 and USB2.0.
- Video, audio and photo files can be played. For details of operations on each file, refer to relevant pages.
- Regular back up is recommended to prevent data loss.
- If you use a USB extension cable, USB HUB or USB Multi-reader, the USB device may not be recognized.
- Some USB device may not work with this unit.
- Some digital cameras and mobile phones are not supported.
- USB Port of the unit cannot be connected to PC. The unit cannot be used as a storage device.



## Playing a file on Android device

This player can play video, audio and photo files contained in the Android device.

1. Connect the Android device to the unit with USB cable. Make sure that MTP is activated on Android device.

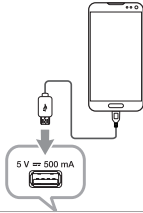

2. Press **HOME** (🏠).
3. Select [MTP] and press **ENTER** (⊙).



File loading may take few minutes depending on the number of content stored in the Android device.

4. Select [Movie], [Photo] or [Music].

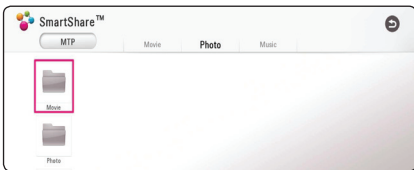

5. Select a file using **▲/▼/◀/▶**, and press **▶(Play)** or **ENTER (⊙)** to play the file.

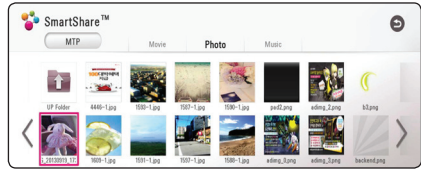

### Notes on Connecting Android device

- This unit can support only the MTP (Media Transfer Protocol) Android device.
- Do not extract the Android device during operation (play, etc.).
- Video, audio and photo files can be played. For details of playing each file type, refer to the relevant pages.
- Regular back up is recommended to prevent data loss.
- If you use a USB extension cable, USB HUB or USB Multi-reader, the Android device may not be recognized.
- Some Android devices may not work with this unit.
- When you use MTP, playing some music, photo, movie, or subtitle files may not work depending on the Android device.

## Playing a file on a network server

### MOVIE MUSIC PHOTO

This unit can play video, audio and photo files located in a DLNA server through your home network.

1. Check the network connection and settings (page 17).
2. Press **HOME** (🏠).
3. Select [SmartShare] and press **ENTER** (⊙).

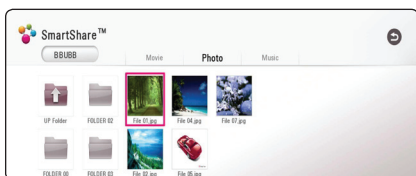

4. Select a DLNA media server in the category.
5. Select [Movie], [Photo] or [Music].
6. Select a file using **▲/▼/◀/▶**, and press **▶** (Play) or **ENTER** (⊙) to play the file.

#### ! Note

- The file requirements are described on page 56.
- Thumbnails of files with unsupported format will be displayed, but cannot be played on this unit.
- The subtitle file name and video file name have to be the same and located at the same folder.
- The playback and operating quality may be affected by your home network condition.
- You may experience connection problems depending on your server's environment.
- To set your PC as a DLNA server, install SmartShare PC Software on your PC. (page 34)

## Using Home Network Server for PC

DLNA stands for Digital Living Network Alliance, which allows users to access video, photo and audio files stored in server and enjoy them on TV via home networking.

Before connecting to PC to play a file, SmartShare PC Software (DLNA) should be installed on your PC.

### About SmartShare PC Software (DLNA)

SmartShare PC Software (DLNA) is for sharing video, audio and photo files stored on your computer to this unit as a DLNA-compatible digital media server.

### Installing SmartShare PC Software (DLNA)

Start up your computer, and insert the supplied CD-ROM disc into your computer's CD-ROM drive. An installation wizard will walk you through the quick and uncomplicated installation process. To install SmartShare PC Software (DLNA), proceed as follows:

1. Close all Microsoft Windows programs and exit any anti-virus software that may be running.
2. Insert the supplied CD-ROM disc into your computer's CD-ROM drive.
3. Click [SmartShare PC Software (DLNA)].
4. Click [Run] to start installation.
5. Click the [Next] button to start installation.
6. If you accept all conditions, click [Yes]. Installation is not possible without this agreement.
7. Follow the directions of the installation wizard displayed on the screen.
8. Click the [Exit] button to complete the installation.

**Note**

- SmartShare PC Software is not supported with Mac OS.
- The SmartShare PC Software (DLNA) is a customized software edition only for sharing files and folders to this player.
- This manual explains operations with the English version of SmartShare PC Software (DLNA) as examples. Follow the explanation referring to the actual operations of your language version.

## Sharing files and folders

On your computer, you must share the folder containing video, audio and/or photo content to play them on this unit.

This part explains the procedure for selecting the shared folders on your computer.

1. Double-click the "SmartShare" icon.
2. Click [Movie], [Photo] or [Music] icon on the center, and then click [Settings] on the top right corner of the SmartShare PC Software. The [Settings] menu appears on the screen.
3. Click [My Shared Contents] tab, and then click  icon. The [Add/Remove Shared Folders] menu appears on the screen.
4. Click the folder containing the files you want to share and then click the [OK]. The checked folder is added to the [My Shared Contents] and then click the [OK] at the bottom of the [Settings] menu.
5. Make sure that the SmartShare (DLNA) service turns on at the [Service] tab.

**Note**

- If the shared folders or files are not displayed on the unit, click the [My Shared Contents] on the [Settings] menu and click  icon.
- For more information, click [HELP] on the [Settings] menu.

## System requirements

### Minimum System

- CPU : Intel® 2.0 GHz or AMD Sempron™ 2000+ processors
- Memory : 1 GB of free RAM
- Graphics card : 64 MB video memory, minimum resolution of 1024 x 768 pixels, and 16 bit color settings
- Free Disc Space : 200 MB
- Windows® XP (Service Pack 2 or higher), Windows Vista®, Windows® 7, Windows® 8, Windows® 8.1
- Windows® Media Player® 11.0 or higher
- Network environment: 100 Mb Ethernet, WLAN

### Recommended System

- CPU : Intel® Core™ Duo or AMD Athlon™ 64X2, 1.7 GHz or better
- Memory : 2 GB of free RAM
- Graphics card : 128 MB video memory, minimum resolution of 1024 x 768 pixels, and 16 bit color settings
- Free Disk Space : 200 MB
- Windows® XP (Service Pack 2 or higher), Windows Vista®, Windows® 7, Windows® 8, Windows® 8.1
- Windows® Media Player® 11.0 or higher
- Network environment: 100 Mb Ethernet, WLAN

## General Playback

### Basic operations for video and audio content

#### To stop playback

Press ■ (Stop) during playback.

#### To pause playback

Press || (Pause) during playback.  
Press ▶ (Play) to resume playback.

#### To play frame-by-frame (Video)

Press || (Pause) during video playback.  
Press || (Pause) repeatedly to play Frame-by-Frame playback.

#### To scan forward or backward

Press ◀◀ or ▶▶ to play fast forward or fast reverse during playback.

You can change the various playback speeds by pressing ◀◀ or ▶▶ repeatedly.

#### To slow down the playing speed (Video)

While the playback is paused, press ▶▶ repeatedly to play various speeds of slow motion.

You can adjust the playing speed and check it by the symbol (||||▶ - |▶) on the screen.

#### To skip to the next/previous title/file

During playback, press ◀◀ or ▶▶ to go to the next title/file or to return to the beginning of the current title/file.

Press ◀◀ twice briefly to step back to the previous title/file.

In the file list menu of a server, there may have many types of content in a folder together. In this case, press ◀◀ or ▶▶ to go to the previous or next content with same type.

### Basic operations for photo content

#### To play a slide show

Press ▶ (Play) to start slide show.

#### To stop a slide show

Press ■ (Stop) while slide show.

#### To pause a slide show

Press || (Pause) while slide show.  
Press ▶ (Play) to re-start the slide show.

#### To skip to the next/previous photo

While viewing a photo in full screen, press < or > to go to the previous or next photo.

### Resume playback

#### MOVIE MUSIC

The unit records the point where you pressed the ■ (Stop) depending on a file.

If "||■ (Resume Stop)" appears on the screen briefly, press ▶ (Play) to resume playback (from the scene point).

If you press ■ (Stop) twice, "■(Complete Stop)" appears on the screen. The unit will clear the stopped point.

#### ! Note

The resume point may be cleared when a button is pressed (for example ⏻ (Power)).

## On-Screen Display

You can display and adjust various information and settings about the content.

### To control video playback

#### MOVIE

You can control playback and set options while watching videos.

During playback, press **INFO/MENU** (□).

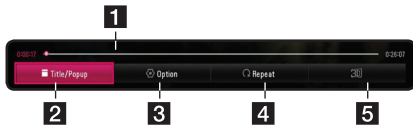

- 1 Progress bar** - Displays the current position and total playing time.
- 2 [Title/Popup]** - Displays the title or the pop-up menu, if available.
- 3 [Option]** - Displays playback information.
- 4 [Repeat]** - Repeats a desired section or sequence. (page 39)
- 5 [3D]** - Adjusts the 3D setting. (page 43)

### Displaying content information on-screen

#### MOVIE

1. During playback, press **INFO/MENU** (□).
2. Select an [Option] using **</>**, and press **ENTER** (⊙).

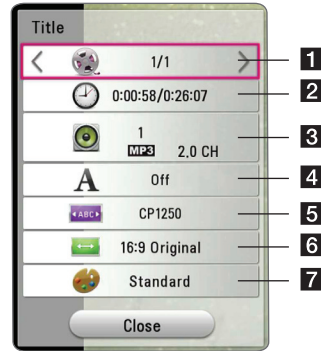

- 1 Title** – Current title number/total number of titles
- 2 Time** – Elapsed playing time/total playback time
- 3 Audio** – Selected audio language or channel
- 4 Subtitle** – Selected subtitle.
- 5 Code Page** – Selected subtitle code.
- 6 TV Aspect Ratio** – Selected TV aspect ratio
- 7 Picture Mode** – Selected picture mode

#### ! Note

- If no button is pressed for a few seconds, the on-screen display disappears.
- A title number cannot be selected on some files.
- Available items may differ depending on titles.

## To control photo view

Controls playback and sets options while viewing pictures in full screen.

You can control playback and set options while viewing pictures in full screen.

While viewing pictures, press **INFO/MENU** (□).



- 1 [Slideshow]** - Starts or pause slide show.
- 2 [Music]** - Select the background music for the slide show (page 42).
- 3 [Option]** - Displays slide show options.
- 4 [Rotate]** - Rotates the photo clockwise.
- 5 [Zoom]** - Displays the [Zoom] menu.

## Setting the slide show option

You can use various options during viewing a photo in full screen.

1. While viewing pictures, press **INFO/MENU** (□).
2. Select an [Option] using **</>**, and press **ENTER** (⊙).

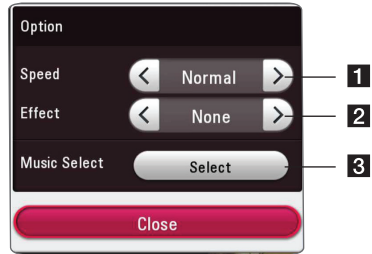

- 1 [Speed]** - Use **</>** to select a delaying speed between photos in a slide show.
- 2 [Effect]** - Use **</>** to select a transition effect between photos in a slide show.
- 3 [Music Select]** - Select the background music for the slide show (page 42).

## Advanced Playback

### Repeat playback

#### MUSIC MOVIE

##### Video files

During playback, press **REPEAT** (↺↻) to select a desired repeat mode.

**A-B** – Selected portion will be repeated continually.

**Title** – The current title will be played back repeatedly.

**All** – All the titles or files will be played back repeatedly.

**Off** – Returns to normal playback.

To return to normal playback, press **CLEAR**.

##### Audio files

During playback, press **REPEAT** (↺↻) repeatedly to select a desired repeat mode.

1 – The current file will be played back repeatedly.

A – All the files will be played back repeatedly.

A ↻ – All the files will be played back repeatedly in random order.

↻ – The files will be played back in random order.

To return to normal playback, press **CLEAR**.

#### ! Note

This function may not work on some titles.

### Repeating a specific portion

#### MOVIE

This unit can repeat a portion you have selected.

1. During playback, press **REPEAT** (↺↻).
2. Select [A-B] and press **ENTER** (⊙).
3. Press **ENTER** (⊙) at the beginning of the portion you wish to repeat.

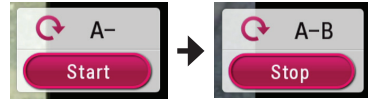

4. Press **ENTER** (⊙) at the end of the portion. Your selected portion will be repeated continually.
5. To return to normal playback, press **CLEAR**.

#### ! Note

- You cannot select a portion less than 3 seconds.
- This function may not work on some title.

### Playing from selected time

#### MOVIE

1. During playback, press **INFO/MENU** (□).
2. Select an [Option] using </>, and press **ENTER** (⊙).
3. Select the [Time] option and then input the required start time in hours, minutes, and seconds from left to right.  
For example, to find a scene at 2 hours, 10 minutes, and 20 seconds, enter "21020".  
Press </> to skip the playback 60 seconds forward or backward.
4. Press **ENTER** (⊙) to start playback from selected time.

#### ! Note

- This function may not work on some titles.
- This function may not work depending on the file type and ability of the DLNA server.

## Selecting a subtitle language

### MOVIE

1. During playback, press **INFO/MENU** (□).
2. Select an [Option] using **</>**, and press **ENTER** (⊙).
3. Use **^/∨** to select the [Subtitle] option.
4. Use **</>** to select desired subtitle language.  
By pressing **ENTER** (⊙), you can set various subtitle options.
5. Press **BACK** (↶) to exit the On-Screen display.

#### ! Note

You can select the [Subtitle] option on the On-Screen display directly by pressing **SUBTITLE** button.

## Hearing a different audio

### MOVIE

1. During playback, press **INFO/MENU** (□).
2. Select an [Option] using **</>**, and press **ENTER** (⊙).
3. Use **^/∨** to select the [Audio] option.
4. Use **</>** to select desired audio language or audio channel.

#### ! Note

Immediately after you have switched sound, there may be a temporary discrepancy between the display and actual sound.

## Changing the TV Aspect Ratio

### MOVIE

You can change the TV aspect ratio setting during playback.

1. During playback, press **INFO/MENU** (□).
2. Select an [Option] using **</>**, and press **ENTER** (⊙).
3. Use **^/∨** to select the [TV Aspect Ratio] option.
4. Use **</>** to select desired option.
5. Press **BACK** (↶) to exit the On-Screen display.

#### ! Note

Even if you change the value of the [TV Aspect Ratio] option in On-Screen display, the [TV Aspect Ratio] option in the [Settings] menu is not changed.

## Changing Subtitle Code Page

### MOVIE

If the subtitle is displayed in broken letter, you can change the subtitle code page to view the subtitle file properly.

1. During playback, press **INFO/MENU** (□).
2. Select an [Option] using **</>**, and press **ENTER** (⊙).
3. Use **^/∨** to select the [Code Page] option.
4. Use **</>** to select desired code option.

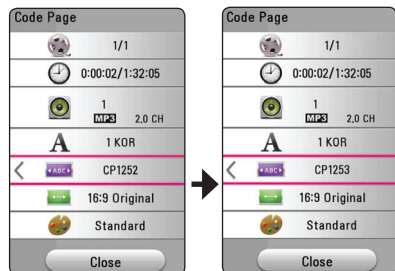

5. Press **BACK** (↶) to exit the On-Screen display.



## Changing the Picture Mode

### MOVIE

You can change the [Picture mode] option during playback.

1. During playback, press **INFO/MENU** (□).
2. Select an [Option] using **</>**, and press **ENTER** (⊙).
3. Use **^/v** to select the [Picture Mode] option.
4. Use **</>** to select desired option.
5. Press **BACK** (⏪) to exit the On-Screen display.

### Setting the [User setting] option

1. During playback, press **INFO/MENU** (□).
2. Select an [Option] using **</>**, and press **ENTER** (⊙).
3. Use **^/v** to select the [Picture Mode] option.
4. Use **</>** to select the [User setting] option, and press **ENTER** (⊙).

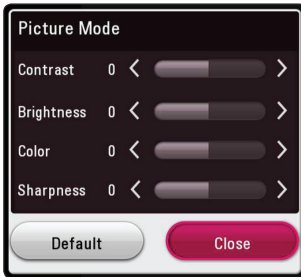

5. Use **^/v/</>** to adjust the [Picture Mode] options.

Select [Default] option then press **ENTER** (⊙) to reset the all video adjustments.

6. Use **^/v/</>** to select the [Close] option, and press **ENTER** (⊙) to finish setting.

## Viewing content information

### MOVIE

The unit can display the content information.

1. Select a file using **^/v/</>**.
2. Press **INFO/MENU** (□) to display the option menu.

The file information appears on the screen.

During video playback, you can display the file information by pressing **POP UP**.

### ! Note

The information displayed on the screen may not correct comparing actual content information.

## Changing content list view

### MOVIE MUSIC PHOTO

On the [SmartShare] menu, you can change the content list view.

Press red (R) colored button repeatedly.

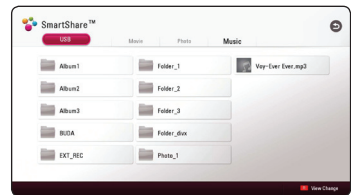
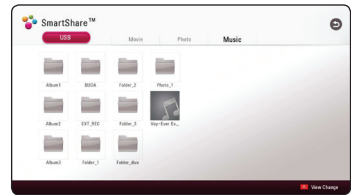

## Selecting a subtitle file

### MOVIE

If the subtitle file name is different from the video file name, you need to select the subtitle file on the [Movie] menu before playing the movie.

1. Use  $\wedge/\vee/$  to select the subtitle file you wish to play in the [Movie] menu.
2. Press **ENTER** (⊙).

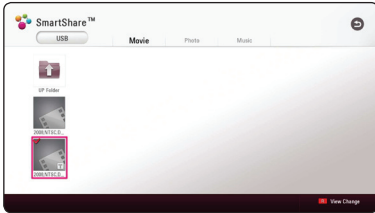

Press **ENTER** (⊙) again to deselect the subtitle file. Selected subtitle file will be displayed when you play the video file.

### ! Note

- If you press ■ (Stop) during playback, the subtitle selection is cancelled.
- This function is not available for playing file on a server via home network.

## Listening to music during slide show

### PHOTO

You can display photo files while listening to audio files.

1. While viewing a photo in full screen, press **INFO/MENU** (⏏) to display the option menu.
2. Select an [Option] using  $\wedge/\vee$ , and press **ENTER** (⊙).
3. Use  $\wedge/\vee$  to select [Music Select] option, and press **ENTER** (⊙) to display the [Music Select] menu.
4. Use  $\wedge/\vee$  to select a device, and press **ENTER** (⊙).

Available device may differ depending on the location of the current photo file.

Photo location	Available Device
USB	USB
MTP	MTP
DLNA server	DLNA server

5. Use  $\wedge/\vee$  to select a file or a folder you wish to play.



Select  $\square$  and press **ENTER** (⊙) to display the upper directory.

### ! Note

When selecting audio file from a server, folder selection is not available. Only file selection is available.

6. Use  $\triangleright$  to select [OK], and press **ENTER** (⊙) to complete music selection.

## Setting the [3D] option

### MOVIE

This function allows you to play 3D content in case of file encoded in 3D.

1. During playback, press **INFO/MENU** (□).
2. Select [3D] using **</>**, and press **ENTER** (⊙)

#### ! Note

If the subtitle is displayed abnormally, set the TV's 3D option to off and the unit's 3D option to on.

## Advanced Features

### Wi-Fi Direct™

#### Connecting to a Wi-Fi Direct™ certified device

##### MOVIE MUSIC PHOTO

This unit can play movie, music and photo files located in a Wi-Fi Direct™ certified device. The Wi-Fi Direct™ technology make the unit to be directly connected to a Wi-Fi Direct™ certified device without connecting to a network device such as an access point.

#### On Wi-Fi Direct™ certified device

1. Turn on the Wi-Fi Direct™ certified device and run its Wi-Fi Direct function.

2. Run DLNA application on the device.

#### On your unit

3. Select [NETWORK] option in the [Settings] menu then press **ENTER** (⊙).
4. Select [Wi-Fi Direct] option, and press **ENTER** (⊙).

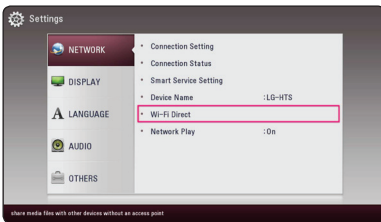

5. Select a Wi-Fi Direct™ device on the list using  $\wedge / \vee / < / >$ , and press **ENTER** (⊙).

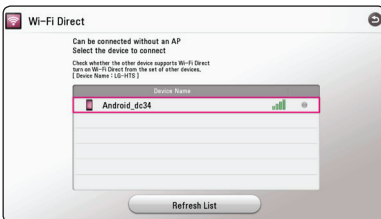

Wi-Fi Direct™ connection will be proceeded. follow the procedure on the screen.

If you want to rescan available Wi-Fi Direct™ device, select the [Refresh List] and press **ENTER** (⊙).

To select a server from the device list, files or folders must be shared by DLNA server from the connected Wi-Fi Direct™ device.

6. Select [Movie], [Photo] or [Music] using  $\wedge / \vee / < / >$ , and press **ENTER** (⊙).

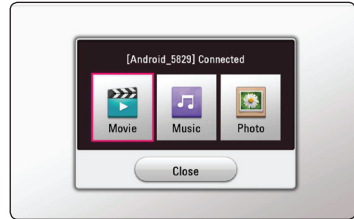

7. Select a file using  $\wedge / \vee / < / >$ , and press **ENTER** (⊙) to play the file.

#### ! Note

- For the purpose of the better transmission, placing the unit from the Wi-Fi Direct™ certified server as close as possible.
- This unit can connect only 1 device at a time. Multiple connection is not available.
- If you try to connect wireless network while a device is connected by Wi-Fi Direct™ function, Wi-Fi Direct™ connection will be force disconnected.
- If this unit and a Wi-Fi Direct™ device are connected to the different local area network, Wi-Fi Direct™ connection may not available.
- If a Wi-Fi Direct™ certified device is not in Wi-Fi direct standby mode, this product cannot find the device.
- When you connect a Wi-Fi Direct™ certified device to your unit, PIN network connection is not supported.

## LG AV Remote

You can control this player with your iPhone or Android phone via your home network. This player and your phone must be connected to your wireless network device such as access point. Visit "Apple iTunes" or "Google Android Market (Google Play Store)" for detailed information of "LG AV Remote".

## Private Sound Mode

By downloading "LG AV Remote" application on your smart phone or tablet, you can connect your headsets, and enjoy the sound from your player on your smart devices.

This feature transmits video signal to TV through HDMI and audio signal to smart phone or tablet through Wi-Fi. For more detailed information, please refer to "LG AV Remote" application.

## Using Bluetooth technology

### About Bluetooth

**Bluetooth®** is wireless communication technology for short range connection.

The sound may be interrupted when the connection interfered by the other electronic wave or you connect the Bluetooth in the other rooms.

Connecting individual devices under **Bluetooth®** wireless technology does not incur any charges. A mobile phone with **Bluetooth®** wireless technology can be operated via the Cascade if the connection was made via **Bluetooth®** wireless technology.

Available Devices : Mobile phone, MP3, Laptop, PDA.

### Bluetooth Profiles

In order to use Bluetooth wireless technology, devices must be able to interpret certain profiles. This unit is compatible with following profile.

A2DP (Advanced Audio Distribution Profile)

## Listening to music stored on the Bluetooth devices

### Pairing your unit and Bluetooth device

Before you start the pairing procedure, make sure the Bluetooth feature is turned on in to your Bluetooth device. Refer to your Bluetooth device's user guide. Once a pairing operation is performed, it does not need to be performed again.

1. Select the Bluetooth function by using the **FUNCTION** (←).  
Appears "BT READY" in display window.
2. Operate the Bluetooth device and perform the pairing operation. When searching for this unit with the Bluetooth device, a list of the devices found may appear in the Bluetooth device display depending on the type of Bluetooth device. Your unit appears as "LG-HTS".
3. When this unit successfully paired with your Bluetooth device, Bluetooth LED of this unit lights up and "BTPAIED" appears in the display window.

#### ! Note

Depending on the Bluetooth device type, some device have a different pairing way. Enter the PIN code (0000) as needed.

4. Listen to music.  
To play a music stored on your Bluetooth device, refer to your Bluetooth device's user guide.

#### ! Note

- When using *Bluetooth*® technology, you have to make a connection between the unit and the Bluetooth device as close as possible and keep the distance. However it may not work well in the case below :
  - There is a obstacle between the unit and the Bluetooth device.
  - There is a device using same frequency with *Bluetooth*® technology such as a medical equipment, a microwave or a wireless LAN device.
- You should connect your Bluetooth device to this unit again when you restart it.
- When you select Bluetooth function again after changing to other functions, Bluetooth connection may be disconnected. You should reconnect the bluetooth device to use this function.
- The sound may be interrupted when the connection interfered by the other electronic wave.
- You cannot control the Bluetooth device with this unit.
- Pairing is limited one Bluetooth device per one unit and multi-pairing is not supported.
- Depending on the type of the device, you may not be able to use the Bluetooth function.
- You can enjoy wireless system using phone, MP3, Notebook, etc..
- The more distance between the unit and the Bluetooth device, the lower the sound quality becomes.
- Bluetooth connection will be disconnected when the unit is turned off or the Bluetooth device gets far from the unit.
- When Bluetooth connection is disconnected, connect the Bluetooth device to the unit again.
- When not connected the Bluetooth, "BT READY" appears on the display window.

## Using the Premium

You can use various content services via Internet with the Premium feature.

1. Check the network connection and settings (page 17).
2. Press **HOME** (🏠).
3. Select the [Premium] using  $\langle / \rangle$ , and press **ENTER** (⊙).



4. Select an online service using  $\wedge / \vee / \langle / \rangle$ , and press **ENTER** (⊙).

### ! Note

- For detailed information of each service, contact to the content provider or visit support link of the service.
- The content of Premium services and service related information, including user interface, is subject to changes. Please refer to the web site of each service for most up-to-date information.
- Using Premium features with wireless network connection may result in improper streaming speed by interference from household devices that are using radio frequencies.
- For the first time to access [Premium] or [LG Smart World] feature, current country setting appears.
- If you want to change the country setting, go to [Settings] > [NETWORK] > [Smart Service Setting] > [Country Setting]. Select [Manual] and press **ENTER** (⊙) on [Country Setting] menu.

## Using the LG Smart World

You can use the LG application services on this unit via Internet. You can easily find and download various applications from LG Smart World.

1. Check the network connection and settings (page 17).
2. Press **HOME** (🏠).
3. Select the [LG Smart World], and press **ENTER** (⊙).



4. Select a category using  $\langle / \rangle$ , and press **ENTER** (⊙).
5. Use  $\wedge / \vee / \langle / \rangle$  to select an application, and press **ENTER** (⊙) to display the information.
6. Press **ENTER** (⊙) while [Install] icon is highlighted. The application will be installed to the unit.  
To install an application to the unit, user needs to sign in. Refer to page 48 for more information of signing in.
7. Press yellow (Y) colored button to display the [My Apps] screen.
8. Select the installed application and press **ENTER** (⊙) to execute it.

### ! Note

- Depending on the region, the [LG Smart World], [My Apps], [Q] and [👤] may not be available.
- To install a paid application, you need to be a paid member. Visit [www.lgappstv.com](http://www.lgappstv.com) for more information.

## Signing in

To use the [LG Smart World] feature, you need to sign in with your account.

1. On the [LG Smart World] or [My Apps] screen, press red **(R)** colored button.
2. Fill the [ID] and [Password] field using the virtual keyboard.

If you do not have an account, press red **(R)** colored button to register.

3. Use **^/V/</>** to select [OK], and press **ENTER (⊙)** to sign in with your account.

If you select the [Auto Sign In] check box, your ID and password are remembered and automatically signed in without entering them.

### ! Note

- If you want to sign in with other account, press red **(R)** colored button on [LG Smart World] or [My Apps] screen, and select [Change User] option.
- To view the information of your account and applications, press red **(R)** colored button on [LG Smart World] or [My Apps] screen, and select [Account Setting] option.

## Searching online content

If you are having difficulties finding specific content from online services, you can use the all-in-one search function by entering keywords in the search menu.

1. Press **HOME (⏠)**.
2. Select the **[Q]** icon on the home menu using **^/V/</>**, and press **ENTER (⊙)**.

The search menu appears on the screen with virtual keyboard.

3. Use **^/V/</>** to select letters then press **ENTER (⊙)** to confirm your selection on the virtual keyboard.
4. When you finish entering the keyword, select [OK] and press **ENTER (⊙)** to display search result.
5. Use **^/V/</>** to select a desired content, and press **ENTER (⊙)** to move to the selected content directly.

### ! Note

- Depending on the region, the [LG Smart World], [My Apps], **[Q]** and **[A]** may not be available.
- The search function does not search content in every online services. It works only in certain online services.



## Using the My Apps Menu

You can move or delete an installed application in the [My Apps] menu.

1. Press **HOME** (🏠).
2. Select the [My Apps], and press **ENTER** (⊙).



### Move an application

1. Select an application, and press green (G) colored button to display the options.
2. Use **^/V** to select [Move], and press **ENTER** (⊙).
3. Use **^/V/</>** to select a position you want to move to, and press **ENTER** (⊙).

### Delete an application

1. Select an application, and press green (G) colored button to display the options.
2. Use **^/V** to select [Delete], and press **ENTER** (⊙).
3. Use **</>** to select [Yes], and press **ENTER** (⊙) to confirm.



#### Note

Depending on the region, the [LG Smart World], [My Apps], [🔍] and [👤] may not be available.

# Troubleshooting

## General

Symptom	Cause & Solution
The Power does not turned on.	<ul style="list-style-type: none"> <li>Plug the power cord into the wall outlet securely.</li> </ul>
The connected USB storage device is not recognized.	<ul style="list-style-type: none"> <li>Try using different USB cable, some USB cables may not support enough current for normal USB operation.</li> <li>If you use a USB extension cable or USB HUB, the USB devices may not be recognized.</li> <li>A USB device which requires additional program installation when you have connected it to a computer is not supported.</li> <li>This unit supports only USB Flash Drive and USB External HDD with FAT32 or NTFS format.</li> </ul>
Cannot play video, photo or audio files.	<ul style="list-style-type: none"> <li>The files are not recorded in a format that the unit can play.</li> <li>The unit does not support the codec of the video file.</li> </ul>
The remote control does not work properly.	<ul style="list-style-type: none"> <li>The remote control is not pointed at the remote sensor of the unit.</li> <li>The remote control is too far from the unit.</li> <li>There is an obstacle in the path of the remote control and the unit.</li> <li>The batteries in the remote control are exhausted.</li> </ul>
The unit is plugged in, but the power will not turn on or off.	<p>You can reset the unit as follows.</p> <ul style="list-style-type: none"> <li>Unplug the power cord, wait at least five seconds, and then plug it in again.</li> </ul>
The unit is not operating normally.	

## Network

Symptom	Cause & Solution
Streaming video services (such as YouTube™, etc.) are often stopped or “buffer” during playback.	<ul style="list-style-type: none"> <li>Your broadband service speed may not be fast enough to stream video services. Contact your Internet Service Provider (ISP) and increase the broadband speed is recommended.</li> </ul>
Media servers are not displayed on the device list.	<ul style="list-style-type: none"> <li>The firewall or anti-virus software on your media server is running. Turn off the firewall or anti-virus software running on your media server.</li> <li>The unit is not connected to the local area network that your media server is connected.</li> </ul>
Cannot connect the unit to the access point or wireless LAN router.	<ul style="list-style-type: none"> <li>The wireless communication may be interrupted from household devices that are using radio frequencies. Move the unit away from them.</li> </ul>
Access point is not displayed on the “Access point name” list.	<ul style="list-style-type: none"> <li>The access point or wireless LAN router may not broadcast its SSID. Set your access point to broadcast its SSID through your computer.</li> <li>Your network device such as access point may not set with available frequency range and channel that this unit can support. Try setting the frequency range and channel on the network device setting.</li> </ul>

## Picture

Symptom	Cause & Solution
There is no picture.	<ul style="list-style-type: none"> <li>Select the appropriate video input mode on the TV so the picture from the unit appears on the TV screen.</li> <li>Connect the video connection securely.</li> <li>Check the [HDMI Color Setting] in the [Settings] menu is set to the appropriate item that conforms to your video connection.</li> <li>Your TV may not support the resolution you have set on the unit. Change the resolution that your TV accepts.</li> <li>The unit's HDMI OUT jack is connected to a DVI device that does not support copyright protection.</li> </ul>
Picture noise appears	<ul style="list-style-type: none"> <li>You are playing a file recorded in a colour system that is different from your TV.</li> <li>Set the resolution which your TV accepts.</li> </ul>

## Sound

Symptom	Cause & Solution
There is no sound or the sound is distorted.	<ul style="list-style-type: none"> <li>The unit is in scan, slow motion, or pause mode.</li> <li>The sound volume is low.</li> <li>Check the wireless speaker connection. (page 13)</li> </ul>

## Customer Support

You can update the unit using the latest software to enhance the products operation and/or add new features. To obtain the latest software for this unit (if updates have been made), please visit <http://www.lg.com> or contact LG Electronics customer care center.

## Open Source Software Notice

To obtain the corresponding source code under GPL, LGPL and other open source licenses, please visit <http://opensource.lge.com>. All referred license terms, warranty disclaimers and copyright notices are available to download with the source code.

## Controlling a TV with the Supplied Remote Control

You can control your TV using the buttons below.

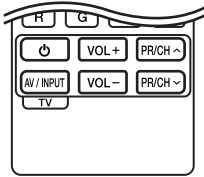

By pressing	You can
⏻ (TV POWER)	Turn the TV on or off.
AV/INPUT	Switch the TV's input source between the TV and other input sources.
VOL +/-	Adjust the volume of the TV
PR/CH ▲/▼	Scan up or down through memorized channels.

### ! Note

Depending on the unit being connected, you may not be able to control your TV using some of the buttons.

## Setting up the remote to control your TV

You can operate your TV with the supplied remote control.

If your TV is listed in the table below, set the appropriate manufacturer code.

1. While holding down ⏻ (TV POWER) button, and press the manufacturer code for your TV with the numerical buttons (see the table below).

Manufacturer	Code number
LG	1(Default), 2
Zenith	1, 3, 4
GoldStar	1, 2
Samsung	6, 7
Sony	8, 9
Hitachi	4

2. Release the ⏻ (TV POWER) button to complete setting.

Depending on your TV, some or all buttons may not function on the TV, even after entering the correct manufacturer code. When you replace the batteries of the remote, the code number you have set may be reset to the default setting. Set the appropriate code number again.

# Network Software Update

## Network update notification

From time to time, performance improvements and/or additional features or services may be made available to units that are connected to a broadband home network. If there is new software available and the unit is connected to a broadband home network, the unit will inform you about the update as follows.

### Option 1:

1. The update menu will appear on the screen when you turn on the unit.
2. Use **</>** to select a desired option and then press **ENTER** (⊙).

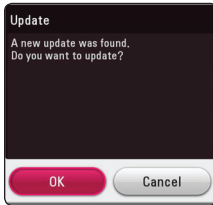

<b>[OK]</b>	Starts the software update.
<b>[Cancel]</b>	Exits the update menu and the home menu appears.

### Option 2:

If the software update is available from the update server, the "Update" icon appears in the Home menu. Press blue (B) colored button to start the update procedure.

## Software update

You can update the unit using the latest software to enhance the products operation and/or add new features. You can update the software by connecting the unit directly to the software update server.

### ! Note

- Before updating the software in your unit, remove USB Device from the unit.
- Before updating the software in your unit, turn the unit off and then turn it back on.
- **During the software update procedure, do not turn off the unit or disconnect AC power, or do not press any button.**
- If you cancel the update, turn off the power and turn it on for stable performance.
- This unit cannot be updated to previous software version.

1. Check the network connection and settings (page 17).
2. Select [Software] option in the [Settings] menu then press **ENTER** (⊙).
3. Select [Update] option, and press **ENTER** (⊙).

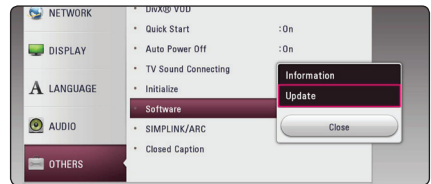

The unit will check for the newest update.

### ! Note

- Pressing **ENTER** (⊙) while checking for the update will end the process.
- If there is no update available, the Message, "No update is found," appears. Press **ENTER** (⊙) to return to the [Home Menu].

4. If newer version exists, the message "A new update was found. The update takes a few minutes. Do you want to update?" appears.
5. Select [OK] to start update. (Selecting [Cancel] will end the update.)
6. The unit starts downloading the newest update from the server. (Downloading will take several minutes depending on your home network condition)
7. To update software the next time, the software update procedure has to be started from the beginning again.)

**Caution**

Do not turn off the power during the software update.

8. When update is completed, the power will be turned off automatically in a few seconds.
9. Turn the power back on. The system now operates with the new version.

**Note**

The Software Update function may not work properly depending on your internet environment. In this case, you can obtain the latest software from the authorized LG Electronics Service Center then update your unit. Refer to "Customer Support" on page 52.

## Additional Information

### File requirement

#### Video files

File Location	File Extension	Codec Format	Audio Format	Subtitle
USB	“.avi”, “.divx”, “.mpg”, “.mpeg”, “.mkv”, “.mp4”, “.asf”, “.wmv”, “.m4v” (DRM free), “.vob”, “.3gp”, “.mov”, “.trp”, “.m2t”, “.mpe”, “.m1v”, “.m2v”, “.wm”, “.flv”, “.ts”, “.dat”	DIVX 3.11, DIVX4, DIVX5. DIVX6 (standard playback only), XVID, MPEG1 SS, H.264/ MPEG-4 AVC, MPEG2 PS, MPEG2 TS, VC-1 SM (WMV3)	Dolby Digital, DTS, MP3, WMA, AAC, AC3	SubRip (.srt / .txt), SAMI (.smi), SubStation Alpha (.ssa/.txt), MicroDVD (.sub/.txt), VobSub (.sub), SubViewer 1.0 (.sub), SubViewer 2.0 (.sub/.txt), TMPlayer (.txt), DVD Subtitle System (.txt)
DLNA	“.avi”, “.divx”, “.mpg”, “.mpeg”, “.mkv”, “.mp4”, “.asf”, “.wmv”, “.m4v” (DRM free), “.mov”, “.mpe”, “.m1v”, “.m2v”, “.flv”, “.ts”, “.dat”	DIVX 3.11, DIVX4, DIVX5. DIVX6 (standard playback only), XVID, MPEG1 SS, H.264/ MPEG-4 AVC, MPEG2 PS, MPEG2 TS, VC-1 SM (WMV3)	Dolby Digital, DTS, MP3, WMA, AAC, AC3	SubRip (.srt / .txt), SAMI (.smi), SubStation Alpha (.ssa/.txt), MicroDVD (.sub/.txt), SubViewer 1.0 (.sub), SubViewer 2.0 (.sub/.txt), TMPlayer (.txt), DVD Subtitle System (.txt)

#### Audio files

File Location	File Extension	Sampling Frequency	Bitrate	Note
USB	“.mp3”, “.wma”, “.wav”, “.m4a” (DRM free), “.flac”, “.ogg”, “.aiff”	within 32 - 48 kHz (WMA), within 16 - 48 kHz (MP3)	within 32 - 192 kbps (WMA), within 32 - 320 kbps (MP3)	Some wav files are not supported on this unit.
DLNA	“.mp3”, “.wma”, “.wav”, “.m4a” (DRM free), “.flac”, “.ogg”	within 32 - 48 kHz (WMA), within 16 - 48 kHz (MP3)	within 32 - 192 kbps (WMA), within 32 - 320 kbps (MP3)	Some wav files are not supported on this unit.

#### Photo files

File Location	File Extension	Recommended Size	Note
USB, DLNA	“.jpg”, “.jpeg”, “.png”, “.gif”, “.mpo”, “.jps”	Less than 4,000 x 3,000 x 24 bit/pixel Less than 3,000 x 3,000 x 32 bit/pixel	Progressive and lossless compression photo image files are not supported.



**! Note**

- The file name is limited to 180 characters.
- Maximum files/Folder: Less than 2000 (total number of files and folders)
- Depending on the size and number of the files, it may take several minutes to read the content on the media.
- File compatibility may differ depending on the server.
- Because the compatibility on DLNA server are tested on the DLNA server (SmartShare PC Software) environment, file requirements and playback functions may differ depending on media servers.
- The file requirements on page 56 are not always compatible. There may have some restrictions by file features and media server's ability.
- Playing video subtitle files is only available by using a DLNA media server created with the SmartShare PC Software supplied with this unit.
- The files from removable media such as USB drive etc. on your media server may not be shared properly.
- This unit cannot support the ID3 Tag embedded MP3 file.
- The total playback time of audio file indicated on the screen may not correct for VBR files.
- HD video files contained on the USB 1.0/1.1 may not played properly. USB 2.0 are recommended to play back HD video files.
- This unit supports H.264/MPEG-4 AVC profile Main, High at Level 4.1. A file with higher level may not be supported.
- This unit does not support files that are recorded with GMC\*<sup>1</sup> or Qpel\*<sup>2</sup>.

\*1 GMC – Global Motion Compensation

\*2 Qpel – Quarter pixel

**! Note**

- A "avi" file which is encoded "WMV 9 codec" is not supported.
- This unit supports UTF-8 files even it contains Unicode subtitle content. This unit can not support the pure Unicode subtitle files.
- Depending on the types of file or ways of recording, it may not play back.
- To be playback a video file, video file name and Subtitle file name must be the same.
- When you play a video file with a extension such as ".ts", ".m2ts", ".mts", ".tp", ".Trp" or ".m2t", your unit may not support subtitle files.
- The total playback time of audio file indicated on the screen may not correct for VBR files.
- Video / Audio codec compatibility may differ depending on video file.

## About DLNA

This Player is a DLNA Certified digital media player that can display and play video, photo and audio content from your DLNA-compatible digital media server (PC and Consumer Electronics).

The Digital Living Network Alliance (DLNA) is a cross-industry organization of consumer electronics, computing industry and mobile device companies. Digital Living provides consumers with easy sharing of digital media through your home network.

The DLNA certification logo makes it easy to find products that comply with the DLNA Interoperability Guidelines. This unit complies with DLNA Interoperability Guidelines v1.5.

When a PC running DLNA server software or other DLNA compatible device is connected to this player, some setting changes of software or other devices may be required. Please refer to the operating instructions for the software or device for more information.

## Certain system requirements

For high definition video playback:

- High definition display that has HDMI input jack.
- HDMI or HDCP capable DVI input on your display device is required for some content (as specified by disc authors).

## Audio Output Specifications

Jack/Setting Source	HDMI OUT		
	PCM	DTS Re-encode <sup>*3</sup>	Auto <sup>*1 *2</sup>
<b>Dolby Digital</b>	PCM 5.1ch	DTS	Dolby Digital
<b>Dolby Digital Plus</b>	PCM 5.1ch	DTS	Dolby Digital Plus
<b>Dolby TrueHD</b>	PCM 5.1ch	DTS	Dolby TrueHD
<b>DTS</b>	PCM 2ch	DTS	DTS
<b>DTS-HD</b>	PCM 2ch	DTS	DTS-HD
<b>Linear PCM 2ch</b>	PCM 2ch	DTS	Linear PCM 2ch
<b>Linear PCM 5.1ch</b>	PCM 5.1ch	DTS	Linear PCM 5.1ch
<b>Linear PCM 7.1ch</b>	PCM 7.1ch	DTS	Linear PCM 7.1ch

\*1 The secondary and interactive audio may not be included in the output bitstream if [Digital Output] option is set to [Auto]. (Except LPCM Codec : the output always include interactive and secondary audio.)

\*2 This unit automatically selects the HDMI audio according to the decoding capability of the connected HDMI device even though [Digital Output] option is set to [Auto].

\*3 If the [Digital Output] option is set to [DTS re-encode], the audio output is limited to 48 kHz and 5.1Ch.

- If the audio format of the digital output does not match the capabilities of your receiver, the receiver will produce a strong, distorted sound or no sound at all.
- Multi-channel Digital Surround Sound via digital connection can only be obtained if your receiver is equipped with a Digital Multi-channel decoder.
- This setting is not available on the input signal from an external device.

## Trademarks and Licenses



The terms HDMI and HDMI High-Definition Multimedia Interface, and the HDMI logo are trademarks or registered trademarks of HDMI Licensing LLC in the United States and other countries.



Manufactured under license from Dolby Laboratories. Dolby and the double-D symbol are trademarks of Dolby Laboratories.



For DTS patents, see <http://patents.dts.com>. Manufactured under license from DTS Licensing Limited. DTS, the Symbol, & DTS and the Symbol together are registered trademarks, and DTS 2.0 Channel is a trademark of DTS, Inc. © DTS, Inc. All Rights Reserved.



DivX Certified® to play DivX® video up to HD 1080p, including premium content.

DivX®, DivX Certified® and associated logos are trademarks of Rovi Corporation or its subsidiaries and are used under license.

Covered by one or more of the following U.S. patents: 7,295,673; 7,460,668; 7,515,710; 7,519,274



DLNA®, the DLNA Logo and DLNA CERTIFIED® are trademarks, service marks, or certification marks of the Digital Living Network Alliance.



The Wi-Fi CERTIFIED Logo is a certification mark of the Wi-Fi Alliance.



The Wi-Fi Protected Setup Mark is a trademark of the Wi-Fi Alliance.



**Bluetooth**® wireless technology is a system which allows radio contact between electronic. Connecting individual devices under **Bluetooth**® wireless technology does not incur any charges. A mobile phone with **Bluetooth**® wireless technology can be operated via the Cascade if the connection was made via **Bluetooth**® wireless technology.

The **Bluetooth**® word mark and logos are owned by the **Bluetooth**® SIG, Inc. and any use of such marks by LG Electronics is under license.

Other trademarks and trade names are those of their respective owners.

## Cinavia Notice

This product uses Cinavia technology to limit the use of unauthorized copies of some commercially-produced film and videos and their soundtracks. When a prohibited use of an unauthorized copy is detected, a message will be displayed and playback or copying will be interrupted.

More information about Cinavia technology is provided at the Cinavia Online Consumer Information Center at <http://www.cinavia.com>. To request additional information about Cinavia by mail, send a postcard with your mailing address to: Cinavia Consumer Information Center, P.O. Box 86851, San Diego, CA, 92138, USA.

This product incorporates proprietary technology under license from Verance Corporation and is protected by U.S. Patent 7,369,677 and other U.S. and worldwide patents issued and pending as well as copyright and trade secret protection for certain aspects of such technology. Cinavia is a trademark of Verance Corporation. Copyright 2004-2012 Verance Corporation. All rights reserved by Verance. Reverse engineering or disassembly is prohibited.

# Specifications

General	
AC adaptor requirements	100 - 240 V ~ 50 / 60 Hz / 25 V $\overline{\text{---}}$ 2 A
Power consumption	30 W
Dimensions (W x H x D)	1 038 mm x 71 mm x 56 mm (40.9" x 2.8" x 2.2") (With foot)
Net Weight (Approx.)	2.45 kg (5.4 lbs)
Operating temperature	5 °C to 35 °C (41 °F to 95 °F)
Operating humidity	5 % to 90 %

Inputs/Outputs	
HDMI OUT (Video/Audio)	19 pin (Type A, HDMI™ Connector) x 1
DIGITAL OPTICAL IN (Audio)	3 V (p-p), Optical jack x 1

Amplifier	
Total	320 W
Front	40 W x 2 (8 $\Omega$ at 1 kHz)
Surround	40 W x 2 (8 $\Omega$ at 1 kHz)
Subwoofer	160 W (3 $\Omega$ at 70 Hz)
THD	10 %

Wireless subwoofer	
Power requirements	120 V ~ 60 Hz
Power consumption	40 W
Type	1 Way 1 speaker
Impedance	3 $\Omega$
Rated input power	160 W
Max. input power	320 W
External dimensions (WxHxD)	170 mm x 360 mm x 316 mm (6.7" x 14.1" x 12.4")
Net Weight	5.55 kg (12.1 lbs)

System	
Signal system	Standard NTSC color TV system
LAN port	Ethernet jack x 1, 10BASE-T / 100BASE-TX
Wireless LAN (internal antenna)	IEEE 802.11b/g/n (2.4 GHz band)
Bus Power Supply (USB)	DC 5 V $\overline{\text{---}}$ 500 mA

- Design and specifications are subject to change without notice.

## Maintenance

### Handling the unit

#### When shipping the unit

Please save the original shipping carton and packing materials. If you need to ship the unit, for maximum protection, re-pack the unit as it was originally packed at the factory.

#### Cleaning the unit

To clean the player, use a soft, dry cloth. If the surfaces are extremely dirty, use a soft cloth lightly moistened with a mild detergent solution. Do not use strong solvents such as alcohol, benzine, or thinner, as these might damage the surface of the unit.

#### Keeping the exterior surfaces clean

- Do not use volatile liquids such as insecticide spray near the unit.
- Wiping with strong pressure may damage the surface.
- Do not leave rubber or plastic products in contact with the unit for a long period of time.

#### Maintaining the unit

The unit is a high-tech, precision device. If the optical pick-up lens and disc drive parts are dirty or worn, the picture quality could be diminished. For details, please contact your nearest authorized service center.

## Important Information relating to Network Services

All information, data, documents, communications, downloads, files, text, images, photographs, graphics, videos, webcasts, publications, tools, resources, software, code, programs, applets, widgets, applications, products and other content ("Content") and all services and offerings ("Services") provided or made available by or through any third party (each a "Service Provider") is the sole responsibility of the Service Provider from whom it originated.

The availability of and access to Content and Services furnished by the Service Provider through the LGE Device are subject to change at any time, without prior notice, including, but not limited to the suspension, removal or cessation of all or any part of the Content or Services.

Should you have any inquiry or problem related to the Content or Services, you may refer to the Service Provider's website for the most up-to-date information. LGE is neither responsible nor liable for customer service related to the Content and Services. Any question or request for service relating to the Content or Services should be made directly to the respective Content and Service Providers.

Please note that LGE is not responsible for any Content or Services provided by the Service Provider or any changes to, removal of, or cessation of such Content or Services and does not warrant or guaranty the availability of or access to such Content or Services.

