



ENGLISH

OWNER'S MANUAL

SoundPlate™

Please read this manual carefully before operating your set and retain it for future reference.

LAP240



www.lg.com
Printed in China

Safety Information



CAUTION: TO REDUCE THE RISK OF ELECTRIC SHOCK DO NOT REMOVE COVER (OR BACK) NO USER-SERVICEABLE PARTS INSIDE REFER SERVICING TO QUALIFIED SERVICE PERSONNEL.



This lightning flash with arrowhead symbol within an equilateral triangle is intended to alert the user to the presence of uninsulated dangerous voltage within the product's enclosure that may be of sufficient magnitude to constitute a risk of electric shock to persons.



The exclamation point within an equilateral triangle is intended to alert the user to the presence of important operating and maintenance (servicing) instructions in the literature accompanying the product.

WARNING: This product contains chemicals known to the State of California to cause cancer and birth defects or other reproductive harm. ***Wash hands after handling.***

WARNING: TO PREVENT FIRE OR ELECTRIC SHOCK HAZARD, DO NOT EXPOSE THIS PRODUCT TO RAIN OR MOISTURE.

CAUTION: The apparatus shall not be exposed to water (dripping or splashing) and no objects filled with liquids, such as vases, shall be placed on the apparatus.

WARNING: Do not install this equipment in a confined space such as a book case or similar unit.

CAUTION: Do not block any ventilation openings. Install in accordance with the manufacturer's instructions.

Slots and openings in the cabinet are provided for ventilation and to ensure reliable operation of the product and to protect it from over heating. The openings shall be never be blocked by placing the product on a bed, sofa, rug or other similar surface. This product shall not be placed in a built-in installation such as a bookcase or rack unless proper ventilation is provided or the manufacturer's instruction has been adhered to.

CAUTION concerning the Power Cord

Most appliances recommend they be placed upon a dedicated circuit;

That is, a single outlet circuit which powers only that appliance and has no additional outlets or branch circuits. Check the specification page of this owner's manual to be certain. Do not overload wall outlets. Overloaded wall outlets, loose or damaged wall outlets, extension cords, frayed power cords, or damaged or cracked wire insulation are dangerous. Any of these conditions could result in electric shock or fire. Periodically examine the cord of your appliance, and if its appearance indicates damage or deterioration, unplug it, discontinue use of the appliance, and have the cord replaced with an exact replacement part by an authorized service centre. Protect the power cord from physical or mechanical abuse, such as being twisted, kinked, pinched, closed in a door, or walked upon. Pay particular attention to plugs, wall outlets, and the point where the cord exits the appliance. To disconnect power from the mains, pull out the mains cord plug. When installing the product, ensure that the plug is easily accessible.

NOTICE: For Product Identification and Compliance/Safety labeling information please refer to Main label on the bottom of unit.

This device is equipped with a portable battery or accumulator.

Safety way to remove the battery or the battery from the equipment: Remove the old battery or battery pack, follow the steps in reverse order than the assembly. To prevent contamination of the environment and bring on possible threat to human and animal health, the old battery or the battery put it in the appropriate container at designated collection points. Do not dispose of batteries or battery together with other waste. It is recommended that you use local, free reimbursement systems batteries and accumulators. The battery shall not be exposed to excessive heat such as sunshine, fire or the like.

IMPORTANT SAFETY INSTRUCTIONS

1. Read these instructions.
2. Keep these instructions.
3. Heed all warnings.
4. Follow all instructions.
5. Do not use this apparatus near water.
6. Clean only with dry cloth.
7. Do not block any ventilation openings. Install in accordance with the manufacturer's instructions.
8. Do not install near any heat sources such as radiators, heat registers, stoves, or other apparatus (including amplifiers) that produce heat.
9. Do not defeat the safety purpose of the polarized or grounding-type plug. A polarized plug has two blades with one wider than the other. A grounding type plug has two blades and a third grounding prong. The wide blade or the third prong are provided for your safety. If the provided plug does not fit into your outlet, consult an electrician for replacement of the obsolete outlet.
10. Protect the power cord from being walked on or pinched particularly at plugs, convenience receptacles, and the point where they exit from the apparatus.
11. Only use attachments/accessories specified by the manufacturer.
12. Use only with the cart, stand, tripod, bracket, or table specified by the manufacturer, or sold with the apparatus. When a cart is used, use caution when moving the cart/apparatus combination to avoid injury from tip-over.



13. Unplug this apparatus during lightning storms or when unused for long periods of time.
14. Refer all servicing to qualified service personnel. Servicing is required when the apparatus has been damaged in any way, such as power-supply cord or plug is damaged, liquid has been spilled or objects have fallen into the apparatus, the apparatus has been exposed to rain or moisture, does not operate normally, or has been dropped.

FCC Compliance Statement

This device complies with part 15 of the FCC rules. Operation is subject to the following two conditions:

- (1) This device may not cause harmful interference, and
- (2) This device must accept any interference received, including interference that may cause undesired operation.

NOTE: This equipment has been tested and found to comply with the limits for a Class B digital device, pursuant to Part 15 of the FCC Rules. These limits are designed to provide reasonable protection against harmful interference in a residential installation. This equipment generates, uses, and can radiate radio frequency energy and, if not installed and used in accordance with the instructions, may cause harmful interference to radio communications. However, there is no guarantee that interference will not occur in a particular installation. If this equipment does cause harmful interference to radio or television reception, which can be determined by turning the equipment off and on, the user is encouraged to try to correct the interference by one or more of the following measures:

- Reorient or relocate the receiving antenna.
- Increase the separation between the equipment and receiver.
- Connect the equipment into an outlet on a circuit different from that to which the receiver is connected.
- Consult the dealer or an experienced radio/TV technician for help.

CAUTION : Any changes or modifications not expressly approved by the party responsible for compliance could void the user's authority to operate this equipment.

FCC WARNING: This equipment may generate or use radio frequency energy. changes or modifications to this equipment may cause harmful interference unless the modifications are expressly approved in the instruction manual. The user could lose the authority to operate this equipment if an unauthorized change or modification is made.

FCC RF Radiation Exposure Statement : This equipment complies with FCC radiation exposure limits set forth for an uncontrolled environment. This equipment should be installed and operated with minimum distance 20 cm between the radiator and your body. End users must follow the specific operating instructions for satisfying RF exposure compliance. This transmitter must not be co-located or operating in conjunction with any other antenna or transmitter.

CAUTION: Regulations of the FCC and FAA prohibit airborne operation of radio-frequency wireless devices because their signals could interfere with critical aircraft instruments.

Responsible Party :

LG Electronics USA, Inc. 1000 Sylvan Avenue
Englewood Cliffs, NJ 07632
TEL. : +1-800-243-0000

Table of Contents

1 Getting Started

- 2 Safety Information
- 6 Unique features
- 6 Introduction
- 6 Accessories
- 7 Front panel
- 7 Rear panel
- 8 Remote control
- 10 Setting up the unit

2 Operating

- 13 Basic operations
 - 13 – Optical input operation
 - 13 – LG Sound Sync
 - 14 – AUTO POWER On/Off
 - 15 – Auto function change
- 16 Using Bluetooth technology
 - 16 – Listening to music stored on the Bluetooth devices
- 17 Using Bluetooth App
 - 17 – Install "LG Bluetooth Remote" App onto Your Bluetooth Device
 - 18 – Activate Bluetooth with "LG Bluetooth Remote" App
- 19 Setting sound effect

3 Troubleshooting

- 20 Troubleshooting

4 Appendix

- 21 Trademarks and licenses
- 22 Specifications
- 23 Maintenance
 - 23 – Handling the unit

1

2

3

4

Unique features

LG Sound Sync

Controls volume level of this unit by the remote control of your LG TV that is compatible with LG Sound Sync.

Bluetooth

Enjoys music from bluetooth device with simple connection.

LG Bluetooth Remote

"LG Bluetooth Remote" is an App designed to let you take control of some of LG's latest Audio devices.

Introduction

Symbols used in this manual

! Note

Indicates special notes and operating features.

! Caution

Indicates cautions for preventing possible damages from abuse.

Accessories

Please check and identify the supplied accessories.

Designs and specifications of the accessories are subject to change without prior notice.

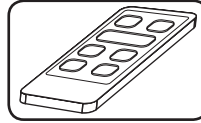

Remote Control (1)

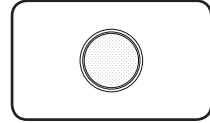

Battery (1)

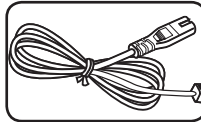

Power cord (1)

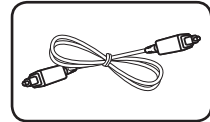

Optical cable (1)

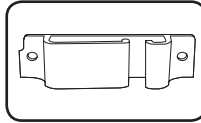

Cable holder (1)

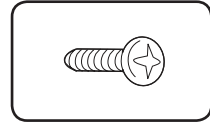

Screw (2)

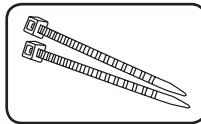

Cable ties for arranging cables (2)

Front panel

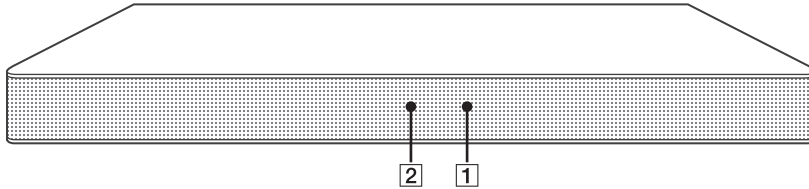

- 1 Remote sensor
- 2 LED indicator

You can check the current state of the unit by the color LED on it. Refer to the table below.

LED Color	Red	Orange	Green	White
LED State				
Off	Disconnected power cord			
On	Standby	Bluetooth paired	Optical function selected	LG sound sync (LG TV) paired
Blink (Twice rapidly)	Sound effect (Standard) is selected.	-	Sound effect (Music) is selected.	Sound effect (Cinema) is selected.
Blink (Twice per second)	Booting	Bluetooth ready	-	LG sound sync (LG TV) ready
Blink (Once per second)	Mute	-	-	-

Rear panel

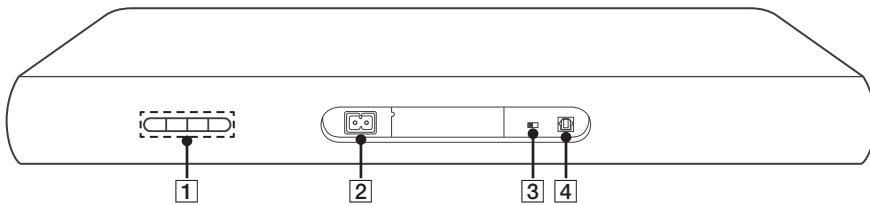

- 1 $\text{⏻} / \text{I}$ (Standby/On)
 $\text{+} / \text{-}$ (Volume)
 Adjusts speaker volume.
F (Function)
 Press it repeatedly to select other function.
- 2 AC power input
- 3 **AUTO POWER ON/OFF**
 Turns on or off AUTO POWER function.
- 4 Optical input

Remote control

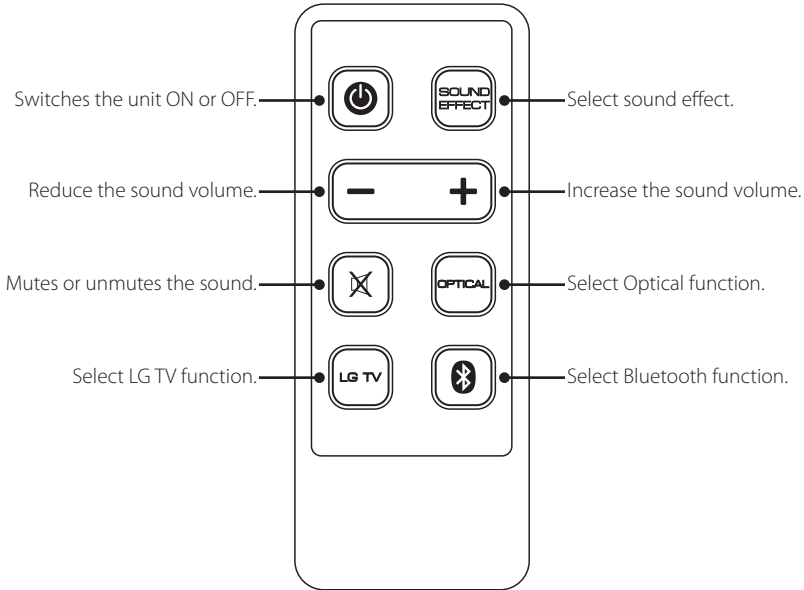

! Note

- Once the unit is shut down to standby, please wait several seconds before trying to use remote again.
- When you press any button on the remote control, the red LED on the main unit blinks twice. (Except (Power), **SOUND EFFECT**)
- The red LED on Unit will be lit if the volume level is adjusted between minimum to maximum.
- The color LED that indicates the current function is lit up.
- The red LED blinks twice rapidly when the sound effect (Standard) is selected.
- The green LED blinks twice rapidly when the sound effect (Music) is selected.
- The white LED blinks twice rapidly when the sound effect (Cinema) is selected.

Battery installation



Caution

Do not open the battery cover by using your finger. Or else, your nail could break.

1. Turn the battery cover counterclockwise by using a coin. Then remove the battery cover.

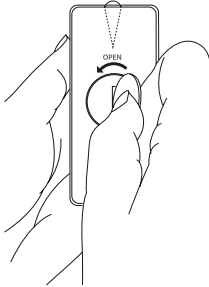

2. Insert and fix the battery with the minus (-) facing in the same direction as the minus (-) on the battery compartment.

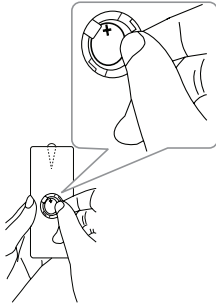

3. Put the battery cover on the remote control and turn it clockwise to close.

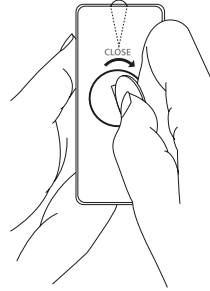

Warning

- DO NOT INGEST BATTERY. CHEMICAL BURN HAZARD.
- The battery used in this device may present a fire or chemical burn hazard if mistreated. Do not recharge, disassemble, incinerate, or heat above 100 °C (212 °F). Replace the battery part no. CR2025 only. Use of another battery may present a risk of fire or explosion. Dispose of used battery. Keep battery away from children. Do not disassemble or dispose of in fire.
- [The remote control supplied with] This product contains a coin/button cell battery. If the coin/button cell battery is swallowed, it can cause severe internal burns in just 2 hours and can lead to death. Keep new and used batteries away from children. If the battery compartment does not close securely, stop using the product and keep it away from children. If you think batteries might have been swallowed or placed inside any part of the body, seek immediate medical attention.

Setting up the unit

This unit is designed to be positioned under your TV.

Before setting up this system with your TV, make sure your TV's specifications.

- **Weight**

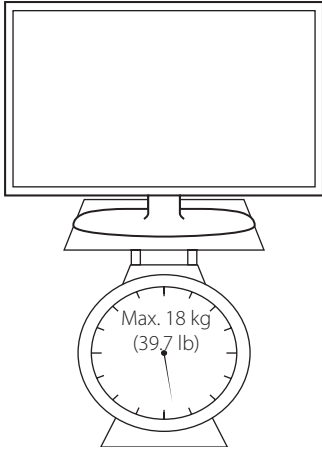

- **Size of the base**

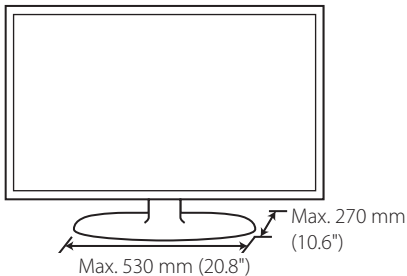

⚠ Caution

- Do not try to set up this unit alone. It may need at least 2 persons to lift your TV. Otherwise it may result in a personal injury and/or property damages.
- Do not connect a CRT type TV to this unit. Because this unit contains magnetic parts, color irregularity may occur on the TV screen.
- Do not put the other objects except a TV or a monitor on the unit.
- The unit must be set up on a stable and horizontal surface.
- Do not put any other object between the unit and the supporting furniture when you set up the unit.

! Recommendation

It is recommended to set up the unit on a sufficiently firm and horizontal surface.

1. Remove the protection caps for woofer from the bottom of this unit.

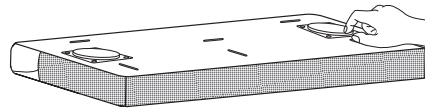

2. Place the unit on the position where you want to place your TV.

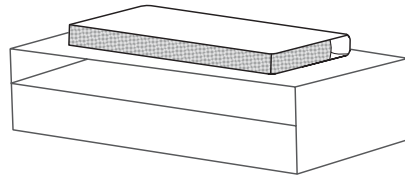

2. Connect the optical cable and the power cord to the unit.

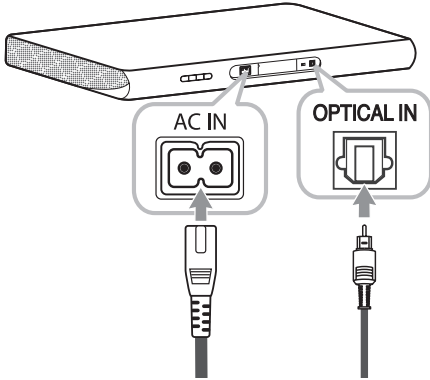

3. Connect another end of optical cable connecting the unit to your TV.

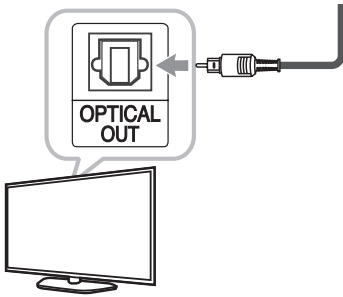

! Note
You can arrange the cables of the unit.

1. Fix the cable holder with screws.

2. Arrange the cables as the below.

4. Place your TV on the centre of the unit.

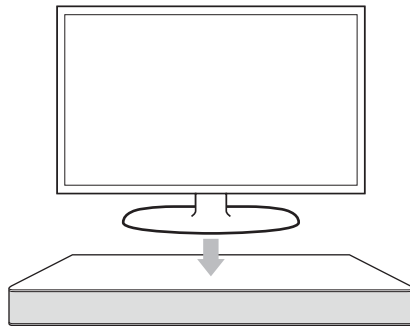

5. Plug in the power cord of the unit.



Caution

- Do not place your TV on the edge of this unit. Otherwise it may result in a personal injury and/or property damages.



- If your TV is over recommended weight (max 18 kg (39.7 lb)) or has a Base larger in area than the Unit do NOT place TV on the Unit.

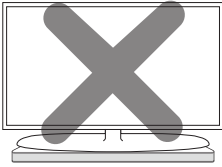

- In this case, it is recommended to place this system in another location such as on the shelf under the TV.

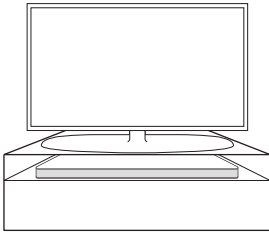

How to Affix the Ferrite Core (Optional)

You may need to attach Ferrite core in order to reduce or eliminate any electrical interference.

1. Open

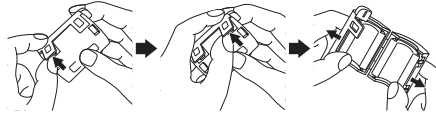

2. Wind (Once)

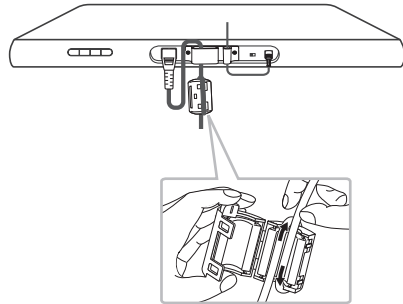

3. Close

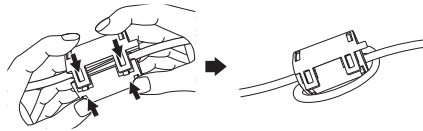

Basic operations

Optical input operation

! Note

Before operating this Unit it is advised to turn OFF TV speaker Sound as it may create sound differences between the 2 products running simultaneously.

Refer to TV menu/Specifications and select from below methods :

- Mute your TV.
- Select [Off] on the TV sound setup menu not to output the sound through the TV.
- Select [Optical output] on the TV sound setup menu to listen to the sound through this unit.

1. Connect your TV to the unit by using an optical cable. (Refer to the pages 10 - 11.)
2. Turn on the unit by pressing  (Power) on the remote control.
3. Select OPTICAL function by using **OPTICAL** on the remote control.

Green LED on the unit is lit up and you can listen to the TV's sound.

! Note

- Set up the sound output of TV to listen to the sound through this unit :
TV setting menu → [Sound] → [TV Sound output] → [External speaker (Optical)]
- Details of TV setting menu vary depending on the manufacturers or models of your TV.

LG Sound Sync



You can control some functions of this unit by your TV's remote control with LG Sound Sync. It is compatible with the LG TV that is supported LG Sound Sync. Make sure of the LG Sound Sync logo on your TV.

Controllable function by LG TV's remote control :
Volume up/down, mute

Refer to the TV's instruction manual for the details of LG Sound Sync.

Make one of the following connections, depending on the capabilities of your equipment.

! Note

- You can also use the remote control of this unit while using LG Sound Sync. If you use TV's remote control again, the unit synchronizes with the TV.
- When the connections failed, make sure of the condition of the TV and power of it.
- Make sure of the condition of this unit and the connection in the cases below when using LG Sound Sync.
 - Turned off the unit.
 - Changing the function to the others.
 - Disconnecting the optical cable.
 - Disconnecting the wireless connection caused by interference or a distance.
- The amount of time to turn off this unit is different depending on your TV when you set AUTO POWER function to ON.
- Volume controls differ slightly depending on what you use among the supplied remote control, LG TV's remote control or "LG Bluetooth Remote" app.

With wired connection

1. Connect your LG TV to the unit by using an optical cable. (Refer to the pages 10 - 11.)
2. Set up the sound output of TV to listen to the sound through this unit :
TV setting menu → [Sound] → [TV Sound output] → [LG Sound Sync (Optical)]
3. Turn on the unit by pressing  (Power) on the remote control.
4. Select OPTICAL function by using **OPTICAL** on the remote control.
Green LED on the unit is lit up and you can listen to the TV's sound.

With wireless connection

1. Turn on the unit by pressing  (Power) on the remote control.
2. Select LG TV function by using **LG TV** on the remote control. Then white LED on the unit starts to blink.
3. Set up the sound output of TV to listen to the sound through this unit :
TV setting menu → [Sound] → [TV Sound output] → [LG Sound Sync (Wireless)]
When connection is completed normally between this unit and your TV, white LED on the unit is lit up.

! Note

- If you turned off the unit directly by pressing  (Power), LG Sound Sync (Wireless) will be disconnected. To use this function again, you should reconnect the TV and the unit.
- Details of TV setting menu vary depending on the manufacturers or models of your TV.
- The device with **Bluetooth®** wireless technology will be disconnected, if Sound Sync function is selected. "LG Bluetooth Remote" app you've already connected is disconnected either.

AUTO POWER On/Off

This unit automatically turns on by an input source : Optical, LG TV or Bluetooth.

When you turn on your TV or an external device connected to this unit, this unit recognizes the input signal and select the suitable function. You can hear the sound from your device.

If you try to connect your Bluetooth device, this unit turns on and ready to pair. Connect your Bluetooth device and play your music.

You can turn on or off AUTO POWER function by using **AUTO POWER ON/OFF** switch on the rear panel of the unit.

! Note

- After the unit is turned on by AUTO POWER function, it will be automatically turned off if there is no signal for a certain period of time from the TV connected by LG Sound Sync (Optical/Wireless).
- After the unit is turned on by AUTO POWER function, it will be automatically turned off if there is no signal for a certain period of time from the external device.
- AUTO POWER function is initially turned on.
- If you turned off the unit directly, it cannot be turned on automatically by AUTO POWER function. However the unit can be turned on by AUTO POWER function when optical signal comes in after 5 seconds of no signal.
- Depending on the connected device, this function may not operate.
- When booting this unit on LG TV function, it takes about 25 seconds to turn it on and the red LED is blinking twice per second. During that time, you cannot control this unit except turn it off.
- If you used Bluetooth or LG TV function before turning off this unit, the unit keeps the current function when Bluetooth or LG TV signals comes in.
Besides, if you used optical function, this unit turns on Bluetooth function when LG TV signal comes in.

Auto power down

This unit will turn itself off to save electric consumption in the case were main unit is not connected to external device and is not used for 20 minutes.

Auto function change

This unit recognizes Bluetooth or optical signals and changes suitable function automatically.

When optical signal comes in

When you turn on the external device connected to this unit by an optical cable, this unit change the function to optical. You can hear the sound from your device.

When you try to connect Bluetooth device

When you try to connect your Bluetooth device to this unit, Bluetooth function is selected. Play your music on the Bluetooth device.

Note

- To change to optical function, it needs 5 seconds of no signal.
- If you are using LG TV function, this unit does not react to the Bluetooth connection.

Using Bluetooth technology

About Bluetooth

Bluetooth is wireless communication technology for short range connection.

The sound may be interrupted when there is interference by the other electronic waves which run on same frequency or if you connect bluetooth devices in the other rooms nearby.

Connecting individual devices under **Bluetooth®** wireless technology does not incur any charges. A mobile phone with **Bluetooth®** wireless technology can be operated via the Cascade if the connection was made via **Bluetooth®** wireless technology.

Available Devices : Mobile phone, MP3, Laptop, PDA etc.

Bluetooth profiles

In order to use **Bluetooth®** wireless technology, devices must be able to interpret certain profiles. This unit is compatible with following profile.

A2DP (Advanced Audio Distribution Profile)

Listening to music stored on the Bluetooth devices

Pairing this unit and Bluetooth device

Before you start the pairing procedure, make sure the Bluetooth feature is turned on in to your Bluetooth device. Refer to your Bluetooth device's user guide. Once a pairing operation is performed, it does not need to be performed again.

1. Select the Bluetooth function by using  on the remote control. Then the orange LED on the unit starts to blink.
2. Operate the Bluetooth device and perform the pairing operation. When searching for this unit with the Bluetooth device, a list of the devices found may appear in the Bluetooth device display depending on the type of Bluetooth device. Your unit appears as "LG SOUND PLATE (XX:XX)".

Note

- XX:XX means the last four digits of BT address. For example, if your unit has a BT address such as 9C:02:98:4A:F7:08, you will see "LG SOUND PLATE (F7:08)" on your Bluetooth device.
- Depending on the Bluetooth device type, some device have a different pairing way. Enter the PIN code (0000) as needed.

3. The orange LED is lit up when this unit successfully paired with your Bluetooth device.
4. Listen to music.
To play a music stored on your Bluetooth device, refer to your Bluetooth device's user guide.

! Note

- When using **Bluetooth®** technology, you have to make a connection between the unit and the bluetooth device as close as possible and keep the distance. However it may not work well in the case below :
 - There is a obstacle between the unit and the bluetooth device.
 - There is a device using same frequency with **Bluetooth®** technology such as a medical equipment, a microwave or a wireless LAN device.
- This unit supports Bluetooth auto pairing. However it does not operate in the case below :
 - When you restart this unit.
 - When you return to Bluetooth function after using LG TV function.
- The sound may be interrupted when the connection interfered by the other electronic wave.
- You cannot control the Bluetooth device with this unit.
- Pairing is limited one Bluetooth device per one unit and multi-pairing is not supported.
- Depending on the type of the device, you may not be able to use the Bluetooth function.
- You can enjoy wireless system using phone, MP3, Notebook, etc..
- The more distant between the unit and the bluetooth device, the lower the sound quality becomes.
- Bluetooth connection will be disconnected when the unit is turned off or the bluetooth device gets far from the unit.
- When Bluetooth connection is disconnected, connect the bluetooth device to the unit again.
- When not connected the Bluetooth, orange LED is blinking.

Using Bluetooth App

! Note

Only Android OS is available to use "LG Bluetooth remote" app with this unit.

About "LG Bluetooth Remote" App

"LG Bluetooth Remote" app brings a suite of new features to this unit.

To enjoy more features, you are recommended to download and install free "LG Bluetooth Remote" app.

Install "LG Bluetooth Remote" App onto Your Bluetooth Device

There are two ways to install" LG Bluetooth Remote" App onto Your Bluetooth Device.

Install "LG Bluetooth Remote" App through QR code

1. Install "LG Bluetooth Remote" app through QR code. Use the scanning software to scan the QR code.



2. Tap an icon for installation.
3. Tap an icon for downloading.

! Note

- Make sure that your Bluetooth device is connected to the Internet.
- Make sure that your Bluetooth device has a scanning software application. If you don't have one, download one from "Google Android Market (Google Play Store)".

Install "LG Bluetooth Remote" App through "Google Android Market (Google Play Store)"

1. Tap the "Google Android Market (Google Play Store)" icon.
2. In the search bar, type in the "LG Bluetooth Remote" and search it.
3. In the search result list, find and tap "LG Bluetooth Remote" to start downloading Bluetooth app.
4. Tap an icon for installation.
5. Tap an icon for downloading.

! Note

- Make sure that your Bluetooth device is connected to the Internet.
- Make sure that your Bluetooth device is equipped with "Google Android Market (Google Play Store)".

Activate Bluetooth with "LG Bluetooth Remote" App

"LG Bluetooth Remote" app helps to connect your bluetooth device to this unit.

1. Tap "LG Bluetooth Remote" app icon on the home screen to open "LG Bluetooth Remote" app, and go to the main menu.
2. Tap [Setting] and select the unit you want.
3. If you want to get more information to operate, tap [Setting] and [Help].

! Note

- "LG Bluetooth Remote" app will be available in the software version as follow;
 - Android O/S : Ver 2.3.3 (or later)
- This unit does not support the multi-pairing. If this unit is already connected with other Bluetooth device, disconnect that device and then try again.
- If you use "LG Bluetooth Remote" app for operation, there would be some differences between "LG Bluetooth Remote" app and the supplied remote control. Use the supplied remote control as necessary.
- Depending on the Bluetooth device, "LG Bluetooth Remote" app may not work.
- After connection of "LG Bluetooth Remote" app, music may be output from your device. In this case, try connecting procedure again.
- If you operate the other applications or change the settings on your Bluetooth device while using "LG Bluetooth Remote" app, "LG Bluetooth Remote" app may operate abnormally.
- When "LG Bluetooth Remote" app operate abnormally, check your Bluetooth device and the connection of "LG Bluetooth Remote" app and then try to connect again.
- Depending on the smart phone's operating system, you have some differences for "LG Bluetooth Remote" operation.
- If you select Bluetooth function after "LG Bluetooth Remote" app has been disconnected, this unit and your Bluetooth device will be paired automatically but you cannot control this unit by "LG Bluetooth Remote" app. To use "LG Bluetooth Remote" app, reconnect the app.
- Even though Bluetooth connection will be disconnected, you can use "LG Bluetooth Remote" app when you change the function to the others except LG TV function.

Setting sound effect

This system has a number of pre-set surround sound fields. You can select a desired sound mode by using **SOUND EFFECT**. A color LED that indicates the sound effect you select will blink rapidly twice.

The displayed items for the equalizer may be different depending on sound sources and effects.

Sound effect	LED blinking	Description
Standard	Red	You can enjoy the sound without equalizer effect.
Music	Green	You can enjoy comfortable and natural sound.
Cinema	White	You can enjoy more immersive and cinematic surround sound.

Note

- In some of surround modes, some speakers, there's no sound or low sound. It depends on the mode of surround and the source of audio, it is not defective.
- You may need to reset the surround mode, after switching the input, sometimes even after the sound file changed.

Troubleshooting

3

Troubleshooting

PROBLEM	CAUSE & CORRECTION
No Power	<ul style="list-style-type: none"> The power cord is unplugged. Plug in the power cord. Check the condition by operating other electronic devices.
No sound	<ul style="list-style-type: none"> Incorrect input source is selected. Check the input source and select the correct input source. The mute function is activated. Press  or adjust the volume level to cancel the mute function. When you are using connection with a external device (set top box, Bluetooth device etc.), adjust volume level of the device.
The remote control does not work properly.	<ul style="list-style-type: none"> The remote control is too far from the unit. Operate the remote control within about 7 m. There is an obstacle in the path of the remote control and the unit. Remove the obstacle. The battery in the remote control is exhausted. Replace the battery with new one.
The AUTO POWER on/off function does not work.	<ul style="list-style-type: none"> Check connection of the external device such as TV, DVD/Blu-Ray player or Bluetooth device. Depending on the connected device, this function may not operate. Check the status of AUTO POWER ON/OFF switch on the rear panel of the unit.
LG Sound Sync does not work.	<ul style="list-style-type: none"> Check whether your LG TV supports LG Sound Sync. Check connection of LG Sound Sync (Optical or wireless). Check sound setting of your TV and this unit.
When you feel the output sound of the unit is low.	<p>Check the details below and adjust the unit according to them.</p> <ul style="list-style-type: none"> With the unit connected with TV, change the AUDIO DIGITAL OUT setting on TV Setup Menu from [PCM] to [AUTO] or [BITSTREAM]. With the unit connected with Player, change the AUDIO DIGITAL OUT setting on Player Setup Menu from [PCM] to [PRIMARY PASS-THROUGH] or [BITSTREAM]. Change Audio DRC setting on Player setup menu to [OFF] state.
There is a noise on the periphery of the unit.	<p>Depending on the type of the furniture where the unit is placed, you might hear a slight noise from the furniture due to the dual subwoofers built within the product.</p> <ul style="list-style-type: none"> Check the supporting furniture whether it is sufficiently firm and horizontal. However, if you still hear a noise, place a tablecloth between the unit and the surface.

Trademarks and licenses



Manufactured under license from Dolby Laboratories. Dolby and the double-D symbol are trademarks of Dolby Laboratories.



For DTS patents, see <http://patents.dts.com>. Manufactured under license from DTS Licensing Limited. DTS, the Symbol, & DTS and the Symbol together are registered trademarks, and DTS 2.0 Channel is a trademark of DTS, Inc. © DTS, Inc. All Rights Reserved.



Bluetooth® wireless technology is a system which allows radio contact between electronic devices.

Connecting individual devices under *Bluetooth*® wireless technology does not incur any charges. A mobile phone with *Bluetooth*® wireless technology can be operated via the Cascade if the connection was made via *Bluetooth*® wireless technology.

The *Bluetooth*® word mark and logos are owned by the *Bluetooth*® SIG, Inc. and any use of such marks by LG Electronics is under license.

Other trademarks and trade names are those of their respective owners.

Specifications

General	
Power requirements	120 V ~ 60 Hz
Power consumption	25 W
Dimensions (W x H x D)	(560 x 54.5 x 320) mm (22" x 2.1" x 12.6") (With foot)
Net Weight (Approx.)	4.4 kg (9.7 lb)
Operating temperature	5 °C to 35 °C (41 °F to 95 °F)
Operating humidity	5 % to 90 %

Inputs	
DIGITAL IN (OPTICAL IN)	3.3 V (p-p), Optical jack
Available Digital Input Audio Sampling Frequency	32 kHz, 44.1 kHz, 48 kHz, 96 kHz

Amplifier	
Total output	100 W
Stereo mode	20 W x 2 (at 1 kHz, 8 Ω)
Surround mode	20 W x 2 (at 1 kHz, 8 Ω)
Built-In subwoofer	20 W (at 100 Hz, 8 Ω)
THD	0.1 %

- Designs and specifications are subject to change without prior notice.

Maintenance

Handling the unit

When shipping the unit

Please save the original shipping carton and packing materials. If you need to ship the unit, for maximum protection, re-pack the unit as it was originally packed at the factory.

Keeping the exterior surfaces clean

- Do not use volatile liquids such as insecticide spray near the unit.
- Wiping with strong pressure may damage the surface.
- Do not leave rubber or plastic products in contact with the unit for a long period of time.

Cleaning the unit

To clean the player, use a soft, dry cloth. If the surfaces are extremely dirty, use a soft cloth lightly moistened with a mild detergent solution. Do not use strong solvents such as alcohol, benzine, or thinner, as these might damage the surface of the unit.



LG Customer Information Center

1-800-243-0000	USA, Consumer
1-888-865-3026	USA, Commercial

Register your product Online!

www.lg.com