



OWNER'S MANUAL REFRIGERATOR- FREEZER

Please read this owner's manual thoroughly before operating and keep it handy for reference at all times.



MFL68266704

www.lg.com



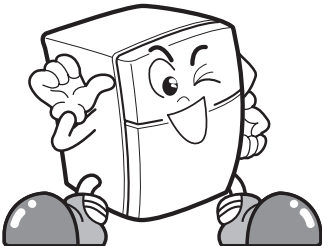

CONTENTS

IMPORTANT SAFETY INFORMATION	3
INSTALLATION	11
INNER PARTS	12
OPERATIONS	13
Starting	
Before Setting The Temperature	
Door Alarm	
Self Test	
Controls For Refrigerator Compartment	
Controls For Freezer Compartment	
Ice Making	
Vegetable Drawer	
Defrosting	
Deodorizer	
SUGGESTIONS ON FOOD STORAGE	16
CLEANING	17
SMART DIAGNOSIS	18
GENERAL INFORMATION	19
⚠ WARNING	20
BEFORE CALLING FOR SERVICE	21



IMPORTANT SAFETY INFORMATION

WARNING

-  Keep ventilation openings, in the appliance enclosure or in the built-in structure, clear of obstruction.
-  Do not use mechanical devices or other means to accelerate the defrosting process, other than those recommended by the manufacturer.
-  Do not damage the refrigerant circuit.
-  Do not use electrical appliances inside the food storage compartments of the appliance, unless they are of the type recommended by the manufacturer.
-  The refrigerant and insulation blowing gas used in the appliance require special disposal procedures. When disposal, please consult with service agent or a similarly qualified person.



This appliance contains a small amount of isobutane refrigerant (R600a), natural gas with high environmental compatibility, but it is also combustible. When transporting and installing the appliance, care should be taken to ensure that no parts of the refrigerating

circuit are damaged.

Refrigerant squirting out of the pipes could ignite or cause an eye injury. If a leak is detected, avoid any naked flames or potential sources of ignition and air the room in which the appliance is standing for several minutes.

In order to avoid the creation of a flammable gas air mixture if a leak in the refrigerating circuit occurs, the size of the room in which the appliance may be sited depends on the amount of refrigerant used. The room must be 1m² in size for every 8g of R600a refrigerant inside the appliance. The amount of refrigerant in your particular appliance is shown on the identification plate inside the appliance.

Never start up an appliance showing any signs of damage. If in doubt, consult your dealer.

IMPORTANT SAFETY INFORMATION

BASIC SAFETY PRECAUTIONS

This guide contains many important safety messages. Always read and obey all safety messages.



This is the safety alert symbol. It alerts you to safety messages that inform you of hazards that can kill or hurt you or others or cause damage to the product. All safety messages will be preceded by the safety alert symbol and the hazard signal word WARNING, or CAUTION. These words mean:



WARNING

You can be killed or seriously injured if you don't follow instructions.



CAUTION

Indicates an imminently hazardous situation which, if not avoided, may result in minor or moderate injury, or product damage only.

All safety messages will identify the hazard, tell you how to reduce the chance of injury, and tell you what can happen if the instructions are not followed.



WARNING

To reduce the risk of fire, electric shock, or injury to persons when using your product, basic safety precautions should be followed, including the following.

Read all instructions before using this appliance.

1. When connecting the power

The dedicated outlet should be used.

- Using several devices at one outlet may cause fire.
- The electric leakage breaker may damage food and the dispenser may be leaked.

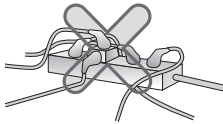

Do not allow the power plug to face upward or to be squeezed at the back of the refrigerator.

Water may be flown into or the plug may be damaged, which causes fire or electric shock.

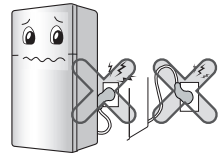

Prevent the power cord from being squeezed or imprinted if the refrigerator is pushed in after the power plug is extracted during the installation.

It becomes the cause of fire or electric shock.

Do not allow the power cord bent or pressed by the heavy object to be damaged.

It may damage the power cord to cause fire or electric shock.



IMPORTANT SAFETY INFORMATION

1. When connecting the power

Do not extend or modify the length of the power plug.

It causes electric shock or fire by the electric damage of the power cord or others.



Unplug the power plug when cleaning, handling or replacing the interior lamp of the refrigerator.

- It may cause electric shock or injury.
- When replacing the interior lamp of the refrigerator, make sure that the rubber ring for preventing the electric spark within the socket is not taken off.

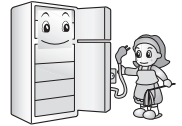

Pull out the power plug not by grasping the cord but the plug of its end.

It may cause electric shock or short circuit to fire.



Remove water or dust from the power plug and insert it with the ends of the pins securely connected.

Dust, water or unstable connection may fire or electric shock.

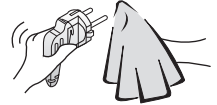

Do not pull out the cord or touch the power plug with wet hands.

It may cause electric shock or injury.

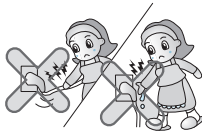

Wait for 5 minutes or longer when reconnecting the plug.

It may cause the operation of the freezer to fail.



Make sure of grounding.

The incorrect grounding may cause breakdown and electric shock.

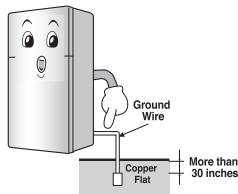

When the power cord or the power plug is damaged or the holes of the outlet are loosed, do not use them.

It may cause electric shock or short circuit to make fire.

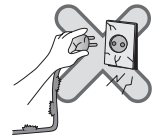

Be sure to use grounded exclusive proper voltage consent for the power plug.
Be sure to use grounded extension consents when extension consents are used.

It becomes the cause of fire.

Make sure to ground for safety.

Do not ground to gas pipe, plastic water pipe, or telephone line.

If there is no ground in the power outlet in the customer's house, separately ground to Compressor base.

IMPORTANT SAFETY INFORMATION

2. When using the refrigerator

Do not place the heavy object or the dangerous object (container with liquid) on the refrigerator.

It may be dropped to cause injury, fire or electric shock when opening or closing the door.



Do not cling to the door or the shelves of the door or the cool chamber.

It may make the refrigerator fall down or damage the hands. Especially, do not allow the children to do the above.



Prevent children from entering the product.

It may endanger the life of a child if the child enters the refrigerator.

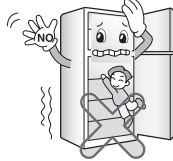

Do not place flower vase, cup, cosmetics, medicine or any container with water on the refrigerator.

It may cause fire, electric shock or injury by dropping down.



Opening and closing the door of the refrigerator vigorously may cause the stored food in the refrigerator basket to fall by shock and hurt the foot, so take precautions.

Do not use or store inflammable materials ether, benzene, alcohol, medicine, LP gas, spray or cosmetics near or in the refrigerator.

It may cause explosion or fire.

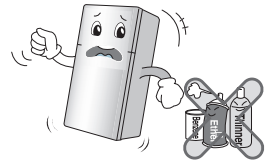

Do not install the refrigerator in the wet place or the place which water or rain splashes.

Deterioration of insulation of electric parts may cause electric leakage.



Do not store the medicine or the academic materials at the refrigerator.

When the material with the strict temperature control is stored, it may be deteriorated or it may make an unexpected reaction to cause any risk.

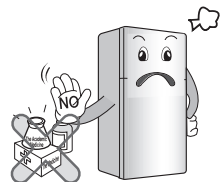

IMPORTANT SAFETY INFORMATION

2. When using the refrigerator

Do not use drier to dry the inside, nor light a candle to remove odor.

It may cause explosion or fire.

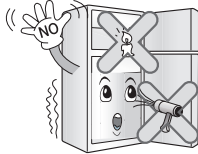

Install in places away from the fire such as the place where flammable gas is leaked.

It may cause fire.

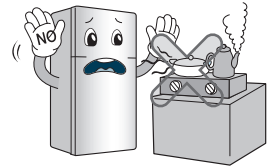

Do not use the combustible spray near the refrigerator.

It may cause fire.

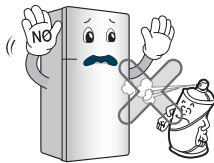

Use the submerged refrigerator after checking it.

It may cause electric shock or fire.

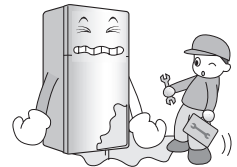

In case of thunder and lightning, or not in use for a long period of time, detach the power plug.

There is a danger of electric shock or fire.

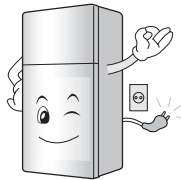

This appliance is not intended for use by persons (including children) with reduced physical, sensory or mental capabilities, or lack of experience and knowledge, unless they have been given supervision or instruction concerning use of the appliance by a person responsible for their safety.

Children should be supervised to ensure that they do not play with the appliance.

When gas is leaked, do not touch the refrigerator or the outlet and ventilate the room immediately.

- The explosion by spark may cause fire or burn.
- Because this refrigerator uses natural gas (isobutene, R600a) as the environment-friendly refrigerant, even a small amount (80~90g) is combustible. When the gas is leaked by the severe damage during delivering, installing or using the refrigerator, any spark may cause fire or burn.

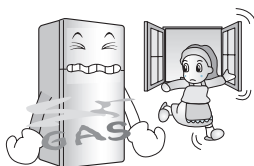

Do not spray water at the outside or the inside of the refrigerator or do not clean it with benzene or thinner.

Deterioration of insulation of electric parts may cause electric shock or fire.

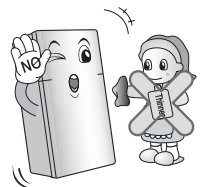

Do not store explosive substances such as aerosol cans with a flammable propellant in this appliance.

IMPORTANT SAFETY INFORMATION

2. When using the refrigerator

Do not allow any person except the qualified engineer to disassemble, repair or alter the refrigerator.

It may cause injury, electric shock or fire.

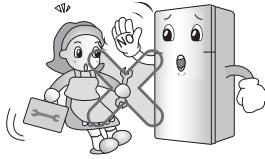

When any strange smell or smoke is detected from the refrigerator, disconnect the power plug immediately and contact to the service center.

It may cause fire.

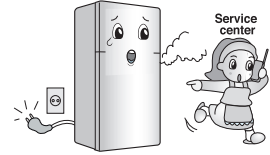

When disposing the refrigerator, remove the packing materials from the door.

It may cause to lock out the child.



Do not use the refrigerator for non-domestic purpose (storing medicine or testing material, using at the ship, etc.).

It may cause an unexpected risk such as fire, electric shock, deterioration of stored material or chemical reaction.

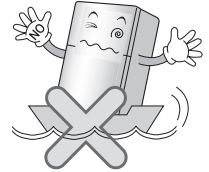

Install the refrigerator on the solid and level floor.

Installing it on the unstable place may cause death by falling down the refrigerator when opening or closing the door.

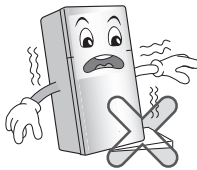

What to do with your old refrigerator.

Your refrigerator contains liquids (refrigerant, lubricant) made of recyclable materials. All these materials must be sent to a recycling waste disposal site as they can be reused after a specific recycling process. Contact local authorities.

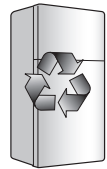

Do not insert the hands or the metal stick into the exit of cool air, the cover, the bottom of the refrigerator, the heatproof grill (exhaust hole) at the backside.

It may cause electric shock or injury.

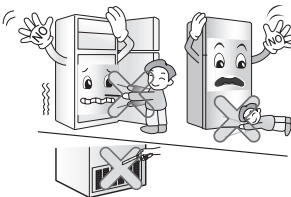

Completely empty inside before taking out the container from the door.

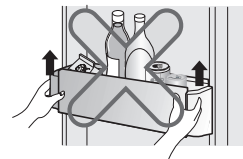

IMPORTANT SAFETY INFORMATION

2. When using the refrigerator

Do not remove the cover on the back.

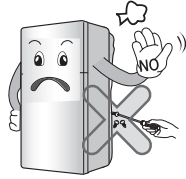

Place all the components in the right places before connecting the power.

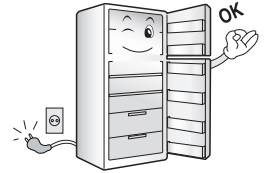

Do not use an Adapter.



Never leave lit candles or incense on the fridge, at risk of causing fire or product damage.



⚠ CAUTION

Violating this direction may cause injury or damage house or furniture. Always be careful, please.

Do not touch food or containers at the freezer with wet hands.

It may cause frostbite.

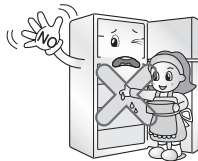

Do not place the food in disorder inside the refrigerator.

The food may fall during opening and closing the door of the refrigerator and hurt people.

Do not put bottle in the freezer.

It may freeze the contents to break the bottle to cause injury.



Do not insert the hands into the bottom of the refrigerator.

The iron plate of the bottom may cause injury.



Carry the refrigerator with the handle bar at the bottom of the front and the top of the rear.

Otherwise, your hands may be slipped to cause injury.

Because the product is heavy, carrying it alone may hurt people or accidents may occur.

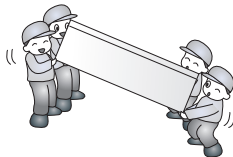

Because opening or closing the door or the home bar of the refrigerator may cause injury to the person around it, be careful, please.

Opening or closing the door may cause feet or hands to be caught in the chink in door or the child to be get hurt by the corner.

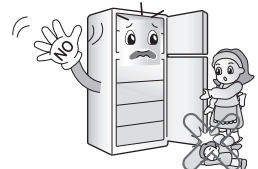

IMPORTANT SAFETY INFORMATION

Do not put any living animal in the refrigerator.

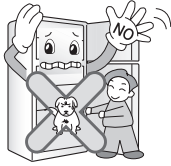

When the power cord is damaged, let a technician to replace it to remove the danger of an accident.

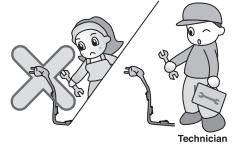

Do not use products such as grinding sponge, brush, iron, or even special products to clean stainless steel, soap products such as alcohol, kerosene, gasoline, wax, or solvent, or strong chemicals such as chlorine, detergent, or vinegar, for the purpose of gloss. These products may damage the protective lacquer, and they may cause risk or stain on the surface of the refrigerator.

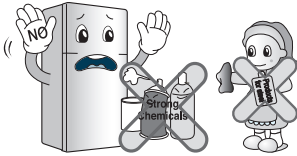

Do not lean on the doors. Hinges may deregulate themselves, harming seal cooler and compromising performance.

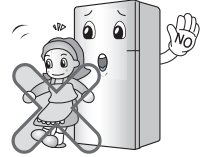

Avoid the contact of oil or fat on the plastic parts. They may cause damage.

! WARNING

Please do not use a dishwasher to clean the lower drawers; the high temperature may cause damage to the baskets which make them unusable.

THIS REFRIGERATOR IS MANUFACTURED WITH GREAT CARE, AND UTILIZES THE LATEST IN TECHNOLOGY.

WE ARE CONFIDENT THAT YOU WILL BE FULLY SATISFIED WITH IT'S PERFORMANCE AND RELIABILITY.

BEFORE YOU START YOUR REFRIGERATOR, PLEASE READ THIS BOOKLET CAREFULLY. IT PROVIDES EXACT INSTRUCTIONS FOR INSTALLATION, OPERATION AND MAINTENANCE, AND ALSO SUPPLIES SOME USEFUL HINTS.

INSTALLATION

1. Select a good location.
Place your refrigerator where it is easy to use.
2. Avoid placing the unit near heat sources, direct sunlight or moisture.
3. To ensure proper air circulation around the fridge -freezer, please maintain sufficient space on both the sides as well as top and maintain at least 2 inches (5 cm) from the rear wall.
4. Don't install this appliance below 5 °C. It may cause the debasement of the refrigerator.
5. To avoid vibrations, the unit must be level.
If required, adjust the leveling screws to compensate for unevenness of the floor. The front should be slightly higher than the rear to aid in door closing.
Leveling screws can be turned easily by tipping the cabinet slightly.
Turn the leveling screws clockwise(➡) to raise the unit, counterclockwise(⬅) to lower it.

NEXT

1. Clean your refrigerator thoroughly and wipe off all dust accumulated during shipping.
2. Install accessories such as ice cube box, etc., in their proper places. They are packed together to prevent possible damage during shipment.
3. You have a model with bar-type handle, assemble the handle according to instruction card.
4. Connect the power supply cord (or plug) to the outlet. Don't double up with other appliances on the same outlet.
5. Prior to storing food, leave your refrigerator on for 2 or 3 hours.
Check the flow of cold air in the freezer compartment to ensure proper cooling.
Your refrigerator is now ready for use.

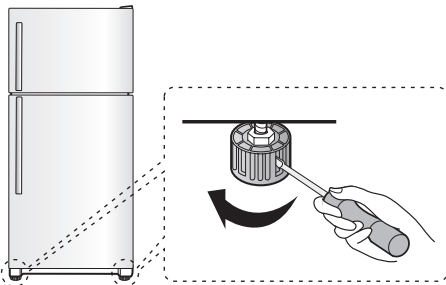

INNER PARTS

FREEZER COMPARTMENT

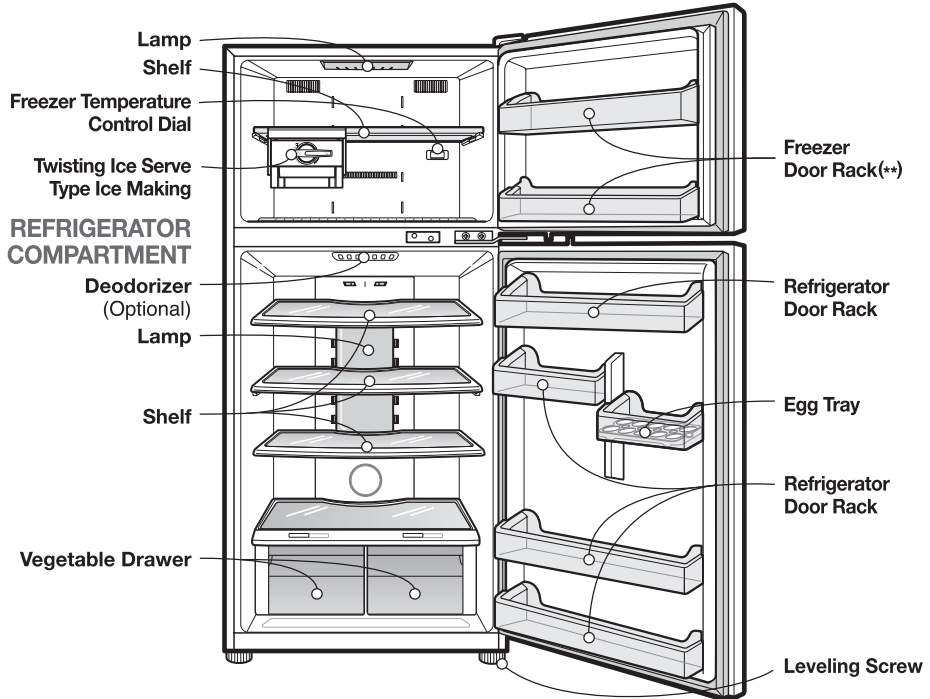

NOTE

- This guide covers several different models. The refrigerator you have purchased may have some or all of the features shown above.
- To keep a position of inner parts like as racks, drawers and shelves supplied by manufacturer is the most efficient usage for energy saving.

SUGGESTION FOR ENERGY SAVING

- Please do not keep the door open for a long time, close door in the shortest time.
- Too much food are not advised to be put in. Enough space should be kept for cool air circulating freely.
- Do not set the temperature of refrigerator lower than needed. Do not put the food near the temperature sensor.
- Allow hot food to cool prior to storing. Placing hot food in the fridge-freezer could spoil other food, and lead to higher electric bills.
- Do not block air vents with food. Smooth circulation of cold air keeps fridge-freezer temperature even.
- Do not open the door frequently. Opening the door lets warm air enter the fridge-freezer, and cause temperature to rise.

OPERATIONS

STARTING

When your refrigerator is first installed, allow it 2-3 hours to stabilize at normal operating temperatures prior to filling it with fresh or frozen foods.

If operation is interrupted, wait 5 minutes before restarting.

BEFORE SETTING THE TEMPERATURE

- The temperature of the refrigerator is kept constant regardless of changes in room temperature. It is recommended that, once set, the temperature settings (the controls for the refrigerator and freezer compartments) not be changed unless necessary.
- This refrigerator has one temperature control button for the refrigerator compartment and one temperature control dial for the freezer compartment.
- The default setting of the temperature control button for the refrigerator compartment is '3°C'.
- The default setting of the temperature control dial for the freezer compartment is '5'.
- This refrigerator has a temperature sensor in the refrigerator compartment. It will start and stop the compressor automatically as needed.

DOOR ALARM

When the door of the refrigerator or the freezer is open for 1 minute, an alarm will sound three times. If the door remains open, the alarm will repeat every 30 seconds.

SELF TEST

- Your refrigerator contains a built in diagnostic capability. If it develops a malfunction in certain areas, it will display an error code to assist the repair technician. While an error code is displayed, other control and display functions will not operate.
- If an error code is displayed, contact a service center. Do not disconnect the power cord from the outlet.

CONTROLS FOR REFRIGERATOR COMPARTMENT

The default setting of the temperature control button for the refrigerator compartment is NORMAL.

To control the fridge temperature, press the FRIDGE TEMP CONTROL button.

When the button is pressed, the LEDs light.

The temperature is set in 7 steps, from MIN to MAX.

- You can select the desired setting point seven steps, from '0°C' to '6°C'.

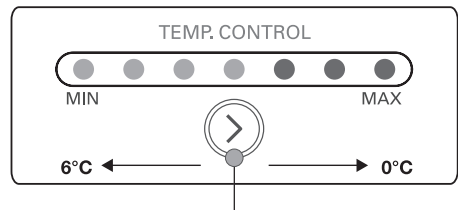

Fridge Temp Control Button

OPERATIONS

CONTROLS FOR FREEZER COMPARTMENT

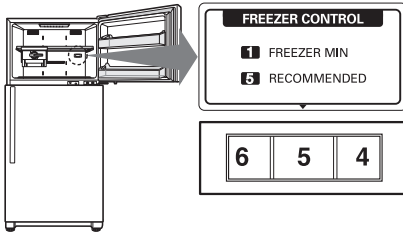

- To lower the temperature in the freezer, turn the knob right and set to a higher number.
To raise the temperature in the freezer, turn the knob left and set to a smaller number.
- Over freezing at **6 ~ 8** is a function that maintain a low temperature in the freezer. But, Refrigerator's cooling speed will be slowed down. Once using **6 ~ 8** levels, return the knob to recommended position in normal time.

ICE MAKING

Twisting Ice Serve Type

- To make ice cubes, fill the ice tray with water and insert in its position.
- To remove ice cubes, hold the lever of the tray and pull turn gently. Then, ice cubes drop in to the ice cube box.

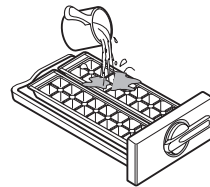
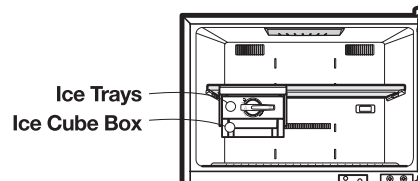

NOTE You can disassemble the Ice Maker to secure space in the freezer.

- **Twisting Ice Serve Type:** Remove 1 and 2.

1. Ice Tray
2. Ice Cube Box.

- WARNING**
- Do not use anything other than water.
 - Fill the water up to the marked line.

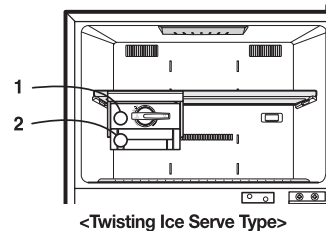

VEGETABLE DRAWER

How to use

- Vegetable drawer can be used through the control of knob.
- Check the position of knob prior to store the food.
- Do not locate the knob on the middle point.

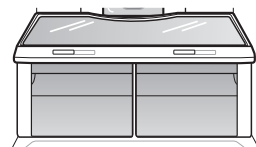

OPERATIONS

DEFROSTING

- Defrosting takes place automatically.
- The defrosted water flows down to the evaporating tray which located in the lower back side of the refrigerator and is evaporated automatically.

DEODORIZER (OPTIONAL)

- Unpleasant odor of food in fresh food compartment is deodorized with no harm to you and the food.

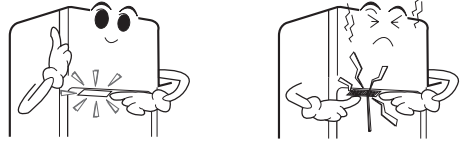

How to use

- As Deodorizer is located in cooling air inlet for circulating air in fresh food compartment, there is no need for any handling.
- Do not prick the cooling air inlet with a sharp tip because Deodorizer may be damaged.
- When storing food with a strong odor, wrap it or store it in a container with a lid because odor may be passed on to other foods.

Re-Using of Deodorizer

- Used some length and the odor is strong, Deodorizer can be revived and re-used.
- Separate Deodorizer in ceiling of refrigerator compartment, using hair drier to remove moisture or malodor and oxidize under sunlight to decomposing malodor by ultraviolet.

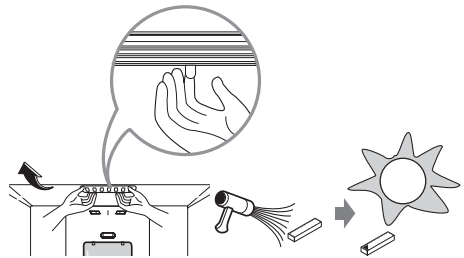

SUGGESTIONS ON FOOD STORAGE

STORING FOOD

- Store fresh food in the refrigerator compartment. How food is frozen and thawed is an important factor in maintaining its freshness and flavor.
- Do not store food which goes bad easily at low temperatures, such as bananas, pineapples, and melons.
- Allow hot food to cool prior to storing. Placing hot food in the refrigerator could spoil other food, and lead to higher electric bills!
- When storing the food, cover it with vinyl wrap or store in a container with a lid. This prevents moisture from evaporating, and helps food to keep its taste and nutrients.
- Do not block air vents with food. Smooth circulation of chilled air keeps refrigerator temperatures even.
- Do not open the door frequently. Opening the door lets warm air enter the refrigerator, and cause temperatures to rise.

FREEZER COMPARTMENT

- Do not store bottles in the freezer compartment - they may break when frozen.
- Do not refreeze food that has been thawed. This causes loss of taste and nutrition.
- When storing frozen food like ice cream for a long period, place it on the freezer shelf, not in the door rack.
- Two stars section **
 - Two stars section means the space stored at $-12^{\circ}\text{C} \sim -18^{\circ}\text{C}$.
 - Freezer foods for short-terms storage.

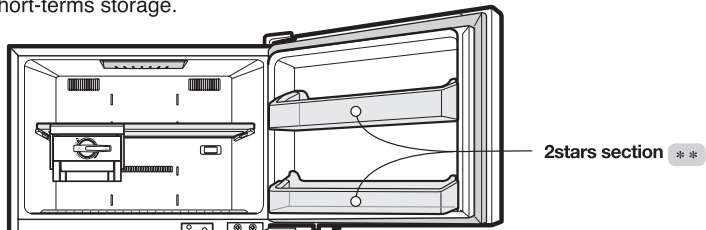

REFRIGERATOR COMPARTMENT

- Avoid placing moist food on deep interior refrigerator shelves, it could freeze upon direct contact with chilled air. To avoid this it is better to store food in the covered container.
- It is desirable to store moist food (especially vegetable and fruit) in the vegetable storage compartment. If it is necessary to store on a shelf of the refrigerator, put it close to the door away from the back wall of the refrigerator to avoid being frozen by the cool circulating in the refrigerator.
- Always clean food prior to refrigeration. Vegetables and fruits should be washed and wiped, and packed food should be wiped clean, to prevent adjacent food from spoiling.
- When storing eggs in their storage rack, ensure that they are fresh, and always store them in a up-right position, which keeps them fresh longer.

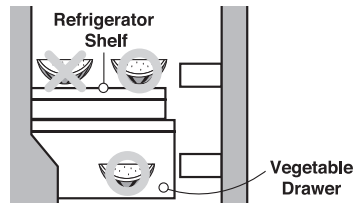

CLEANING

It is important that your refrigerator be kept clean to prevent undesirable odors. Spilled food should be wiped up immediately, since it may acidify and stain plastic surfaces if allowed to settle.

Never use metallic scouring pads, brushes, coarse abrasive cleaners or strong alkaline solutions on any surface.

Before you clean, however, remember that damp objects will stick or adhere to extremely cold surfaces. Do not touch frozen surfaces with wet or damp hands.

EXTERIOR - Use a lukewarm solution of mild soap or dish washable solution to clean the durable finish of your refrigerator. Wipe with a clean, damp cloth and then dry.

INTERIOR - Regular cleaning of the interior and interior parts is recommended. Use a lukewarm solution of mild soap or dish washable solution to clean the durable finish of your refrigerator. Wipe with a clean, damp cloth and then dry.

INTERIOR PARTS - Wash compartment shelves, door racks, storage trays and magnetic door seals etc. Use a lukewarm solution of mild soap or dish washable solution to clean the durable finish of your refrigerator. Wipe with a clean, damp cloth and then dry.

WARNING

Always remove power cord from the wall outlet prior to cleaning in the vicinity of electrical parts (lamps, switches, controls, etc.).

Wipe up excess moisture with a sponge or cloth to prevent water or liquid from getting into any electrical part and causing electric shock. Do not use flammable or toxic cleaning liquids.

- Caution for Cleaning Not in use : Surface active agent, Car wax, Anticorrosive, All sorts of oil, Gasoline, Acids, Wax.
- Usable Detergent Vegetable dish washable solution, Soapy water
- When careless using, it can occur a color change.

SMART DIAGNOSIS (Only for applied models)

Smart diagnosis function is... 

Use the function to contact the service center and receive precise diagnosis when the refrigerator malfunctions or fails. Use it only to connect to the consultant and do not use it in normal times.

How to use the function

1. Open the fridge (lower) door.
2. Press the refrigerator door open detection switch 5 times as in the figure to make the light inside the chamber blink.
(The locations of the door open detection switches of each model may be different, so refer to the following figure to check the location.)

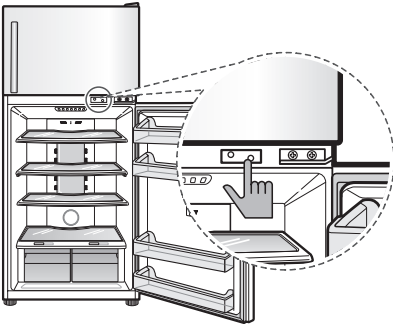
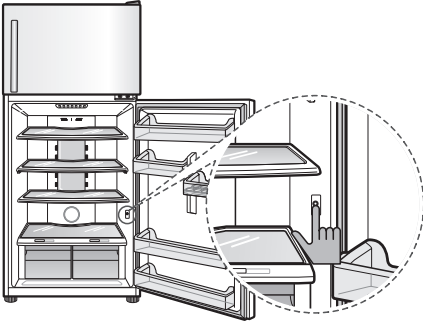

3. Open the freezer (upper) door and place the phone near the speaker hole at the top right.

Check if the speaking side(microphone) of the telephone is toward the speaker hole.

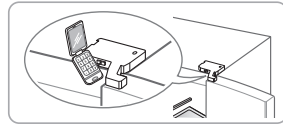

4. Do not take away the telephone while data is being transmitted.

During the data transmission for smart diagnosis, wait with the telephone placed near the speaker hole at the top right side.

CAUTION

The transmission sound may be irritating.
Do not take away the telephone until the sound stops for good diagnosis.

5. After the completion of the data transmission, listen to the explanation of the consultant about the result of the smart diagnosis.

When the data transmission is completed, along with the display of the data transmission completion, the refrigerator will be automatically turned off and on a few seconds later.

Listen to the explanation of the consultant about the result of the analyzed diagnosis and follow the instructions.

Be aware!

- Difference of the regional call qualities may have influence on the function.
- If you use home phone, better communication performance will enable much better service.
- Smart diagnosis data transmission may not be fluent due to call quality problem, and in such case, smart diagnosis service may be difficult.

GENERAL INFORMATION

VACATION TIME

During average length vacations, you will probably find it best to leave the refrigerator in operation. Place freezable items in freezer for longer life. When you plan to be away for an extended period, remove all food, disconnect the power cord, clean the interior thoroughly, and leave each door OPEN to prevent odor formation.

POWER FAILURE

Most power failures are corrected in an hour or two and will not affect your refrigerator temperatures. However, you should minimize the number of door openings while the power is off. During power failures of longer duration, place a block of dry ice on top of your frozen packages.

IF YOU MOVE

Remove or securely fasten down all loose items inside the refrigerator. To avoid damaging the leveling screw(s), turn them all the way into the base.

APPLIANCE USAGE RANGE

This appliance is intended to be used in household and similar applications such as

- staff kitchen areas in shops, offices and other working environments;
- farm houses and by clients in hotels, motels and other residential type environments;
- bed and breakfast type environments;
- catering and similar non-retail applications.

ANTI-CONDENSATION PIPE

The outside wall of the refrigerator cabinet may sometimes get warm, especially just after installation.

Don't be alarmed. This is due to the anti-condensation pipe, which pumps hot refrigerant to prevent "sweating" on the outer cabinet wall.

Anti-Condensation Pipe

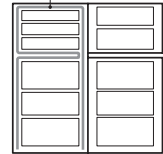

⚠ CAUTION

Electrical Shock Hazard

Before replacing a burned-out light bulb, either unplug the refrigerator or turn off power at the circuit breaker or fuse box.

NOTE: Moving the control to the OFF position does not remove power to the light circuit.

WARNING

DO NOT USE AN EXTENSION CORD

If possible, connect the refrigerator to its own individual electrical outlet to prevent it and other appliances or household lights from causing an overload that could cause a power outage.

ACCESSIBILITY OF SUPPLY PLUG

The refrigerator-freezer should be so positioned that the supply plug is accessible for quick disconnection when accident happens.

SUPPLY CORD REPLACEMENT

If the supply cord is damaged, it must be replaced by the manufacturer or its service agent or a similarly qualified person in order to avoid a hazard.

VERY DANGEROUS ATTRACTION

An empty refrigerator can be a dangerous attraction to children. Remove either gaskets, latches, lids or the entire door from your unused appliance, or take some other action to make it harmless.

ABOUT GROUNDING (EARTHING)

In the event of an electric short circuit, grounding (earthing) reduces the risk of electric shock by providing an escape wire for the electric current.

In order to prevent possible electric shock, this appliance must be grounded.

Improper use of the grounding plug can result in an electric shock. Consult a qualified electrician or service person if the grounding instructions are not completely understood, or if you have doubts on whether the appliance is properly grounded.

DO NOT MODIFY OR EXTEND THE POWER CORD LENGTH.

It will cause electric shock or fire.

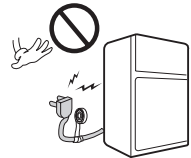

This appliance must be grounded (earthed).

DON'T WAIT! DO IT NOW!

Do not store inflammable materials, explosives or chemicals in the refrigerator.

BEFORE CALLING FOR SERVICE

SERVICE CALLS CAN OFTEN BE AVOIDED!

IF YOU FEEL YOUR REFRIGERATOR IS NOT OPERATING PROPERLY, CHECK THESE POSSIBLE CAUSES FIRST :

PROBLEM	POSSIBLE CAUSES
REFRIGERATOR DOES NOT OPERATE	<ul style="list-style-type: none">● Has a house fuse blown or circuit breaker tripped?● Has the power cord plug been removed or loosened from the electrical wall outlet?
REFRIGERATOR OR FREEZER COMPARTMENT TEMPERATURE TOO WARM	<ul style="list-style-type: none">● Temperature control not set on proper position.● Appliance is placed close to wall or heat source.● Warm weather-frequent door openings.● Door left open for a long time.● Large amount of foods are kept in the refrigerator.
ABNORMAL NOISE(S)	<ul style="list-style-type: none">● Refrigerator is installed in a weak or uneven place, or leveling screw needs adjusting.● Unnecessary objects placed in the back side of the refrigerator.
REFRIGERATOR HAS ODOR	<ul style="list-style-type: none">● Foods with strong odors should be tightly covered or wrapped.● Interior needs cleaning.
DEW FORMS ON THE CABINET SURFACE	<ul style="list-style-type: none">● Not unusual during periods of high humidity.● Door may have been left ajar.



For any Suggestion, Opinion & Complaints,
Within UAE please Call 800 54 (LG)

Out side UAE please contact to our local dealer or
log into www.lg.com

LG Customer Information Center