



ENGLISH

FRANÇAIS

OWNER'S MANUAL

# Micro Hi-Fi System

Please read this manual carefully before operating your set and retain it for future reference.

CM2640 (CM2640, CMS2640F)



[www.lg.com](http://www.lg.com)

# Safety Information



**CAUTION:** TO REDUCE THE RISK OF ELECTRIC SHOCK DO NOT REMOVE COVER (OR BACK) NO USER-SERVICEABLE PARTS INSIDE REFER SERVICING TO QUALIFIED SERVICE PERSONNEL.



This lightning flash with arrowhead symbol within an equilateral triangle is intended to alert the user to the presence of uninsulated dangerous voltage within the product's enclosure that may be of sufficient magnitude to constitute a risk of electric shock to persons.



The exclamation point within an equilateral triangle is intended to alert the user to the presence of important operating and maintenance (servicing) instructions in the literature accompanying the product.

**WARNING:** TO PREVENT FIRE OR ELECTRIC SHOCK HAZARD, DO NOT EXPOSE THIS PRODUCT TO RAIN OR MOISTURE.

**WARNING:** Do not install this equipment in a confined space such as a book case or similar unit.

**CAUTION:** Do not block any ventilation openings. Install in accordance with the manufacturer's instructions.

Slots and openings in the cabinet are provided for ventilation and to ensure reliable operation of the product and to protect it from over heating. The openings shall be never be blocked by placing the product on a bed, sofa, rug or other similar surface. This product shall not be placed in a built-in installation such as a bookcase or rack unless proper ventilation is provided or the manufacturer's instruction has been adhered to.

**CAUTION:** This product employs a Laser System. To ensure proper use of this product, please read this owner's manual carefully and retain it for future reference. Shall the unit require maintenance, contact an authorized service center. Use of controls, adjustments or the performance of procedures other than those specified herein may result in hazardous radiation exposure. To prevent direct exposure to laser beam, do not try to open the enclosure.

### CAUTION concerning the Power Cord

Most appliances recommend they be placed upon a dedicated circuit;

That is, a single outlet circuit which powers only that appliance and has no additional outlets or branch circuits. Check the specification page of this owner's manual to be certain. Do not overload wall outlets. Overloaded wall outlets, loose or damaged wall outlets, extension cords, frayed power cords, or damaged or cracked wire insulation are dangerous. Any of these conditions could result in electric shock or fire. Periodically examine the cord of your appliance, and if its appearance indicates damage or deterioration, unplug it, discontinue use of the appliance, and have the cord replaced with an exact replacement part by an authorized service center. Protect the power cord from physical or mechanical abuse, such as being twisted, kinked, pinched, closed in a door, or walked upon. Pay particular attention to plugs, wall outlets, and the point where the cord exits the appliance. To disconnect power from the mains, pull out the mains cord plug. When installing the product, ensure that the plug is easily accessible.

This device is equipped with a portable battery or accumulator.

**Safety way to remove the battery or the battery from the equipment:** Remove the old battery or battery pack, follow the steps in reverse order than the assembly. To prevent contamination of the environment and bring on possible threat to human and animal health, the old battery or the battery put it in the appropriate container at designated collection points. Do not dispose of batteries or battery together with other waste. It is recommended that you use local, free reimbursement systems batteries and accumulators. The battery shall not be exposed to excessive heat such as sunshine, fire or the like.

**CAUTION:** The apparatus shall not be exposed to water (dripping or splashing) and no objects filled with liquids, such as vases, shall be placed on the apparatus.

# Table of Contents

## 1 Getting Started

---

- 2 Safety Information
- 6 Unique Features
- 6 Accessories
- 7 Playable file Requirement
- 7 – Music file requirement
- 8 Front Panel
- 10 Rear Panel
- 11 Remote Control

## 2 Connecting

---

- 12 Connecting to speakers
- 12 – Attaching the speakers to the unit
- 12 Antenna Connection
- 13 Optional Equipment Connection
- 13 – USB Connection
- 13 – PORT. IN Connection
- 14 – PHONES Connection

## 3 Operating

---

- 15 Basic Operations
- 15 – CD/USB Operations
- 15 – Android device Operation
- 18 Using a Bluetooth wireless technology
- 18 – Listening to music of a Bluetooth device
- 20 Using Bluetooth App
- 20 – About “LG Bluetooth Remote” App
- 20 – Install “LG Bluetooth Remote” App onto Your Bluetooth Device
- 21 – Activate Bluetooth with “LG Bluetooth Remote” App
- 22 Radio Operations
- 22 Listening to the radio
- 22 – Improving poor FM reception
- 22 – Presetting the Radio Stations
- 22 – Deleting all the saved stations
- 23 Other Operations
- 23 – Programmed Playback
- 23 – Displaying file information
- 23 – Turn off the sound temporarily
- 23 – DEMO
- 24 – Selecting a folder and an MP3/WMA/FLAC file
- 24 – Deleting an MP3/WMA/FLAC file
- 25 Sound adjustment
- 25 – Setting the sound mode
- 25 Setting the Clock
- 25 – Setting the Clock through “LG Bluetooth Remote” App
- 26 – Using your player as an alarm clock
- 26 – Sleep Timer Setting
- 26 – Dimmer
- 26 – Auto Power Down
- 27 Advanced Operation
- 27 – Recording on USB
- 27 – To select recording bit rate and speed

## 4 Troubleshooting

---

28 Troubleshooting

## 5 Appendix

---

- 29 Trademarks and Licenses
- 30 Specifications
- 31 Maintenance
  - 31 – Notes on Discs
  - 31 – Handling the Unit

1

2

3

4

5

1

Getting Started

## Unique Features

### Bluetooth®

Listens to music stored on your bluetooth device.

### Portable In

Listens to music from your portable device. (MP3, Notebook, etc)

### Connect to Android device

Enjoys music from Android device with simple connection.

### USB Direct Recording

Records music to your USB device.

### LG Bluetooth Remote

LG Bluetooth Remote is an App designed to let you take control of some of LG's latest Audio devices. Refer to the page 20-21.

## Accessories

Please check and identify the supplied accessories.

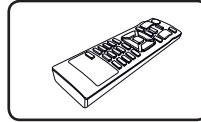

Remote Control (1)

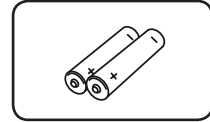

Battery (2)

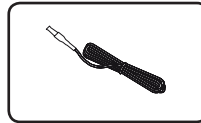

FM Antenna (1)

# Playable file Requirement

## Music file requirement

MP3/ WMA/FLAC file compatibility with this unit is limited as follows :

- Sampling frequency :  
MP3 : within 8 to 48 kHz  
WMA : within 8 to 48 kHz  
FLAC : within 8 to 96 kHz(USB),  
within 8 to 48 kHz(CD)
- Bit rate : within 8 to 320 kbps (MP3),  
40 to 192 kbps (WMA)
- Maximum files : Under 999
- File extensions : ".mp3"/ ".wma"/ ".flac"
- CD-ROM file format : ISO9660/ JOLIET
- Support channel(FLAC) : Up to 2 channel
- Support output bit/sample (FLAC) : 16bit
- bps(FLAC) : Up to 2.5Mbps

The DTS is not supported. In case of DTS audio format, audio is not output.

You have to set the disc format option to [Mastered] in order to make the discs compatible with the LG players when formatting rewritable discs. When setting the option to Live File System, you cannot use it on LG players. (Mastered/ Live File System : Disc format system for Windows Vista)

## Compatible USB Devices

- MP3 Player : Flash type MP3 player.
- USB Flash Drive :  
Devices that support USB2.0 or USB1.1.
- The USB function of this unit does not support all USB devices.

## USB device requirement

- Devices which require additional program installation when you have connected it to a computer, are not supported.
- Do not extract the USB device while in operation.
- For a large capacity USB, it may take longer than a few minutes to be searched.
- To prevent data loss, back up all data.
- If you use a USB extension cable or USB hub, the USB device is not recognized.
- Using NTFS file system is not supported. (Only FAT(16/ 32) file system is supported.)
- This unit is not supported when the total number of files is 1 000 or more.
- External HDD, Card readers, Locked devices, or hard type USB devices, mobile phone are not supported.
- USB port of the unit cannot be connected to PC. The unit cannot be used as a storage device.
- Some USB may not work with this unit.
- In power on state, you can charge your Android device via USB port.

# Front Panel

1

Getting Started

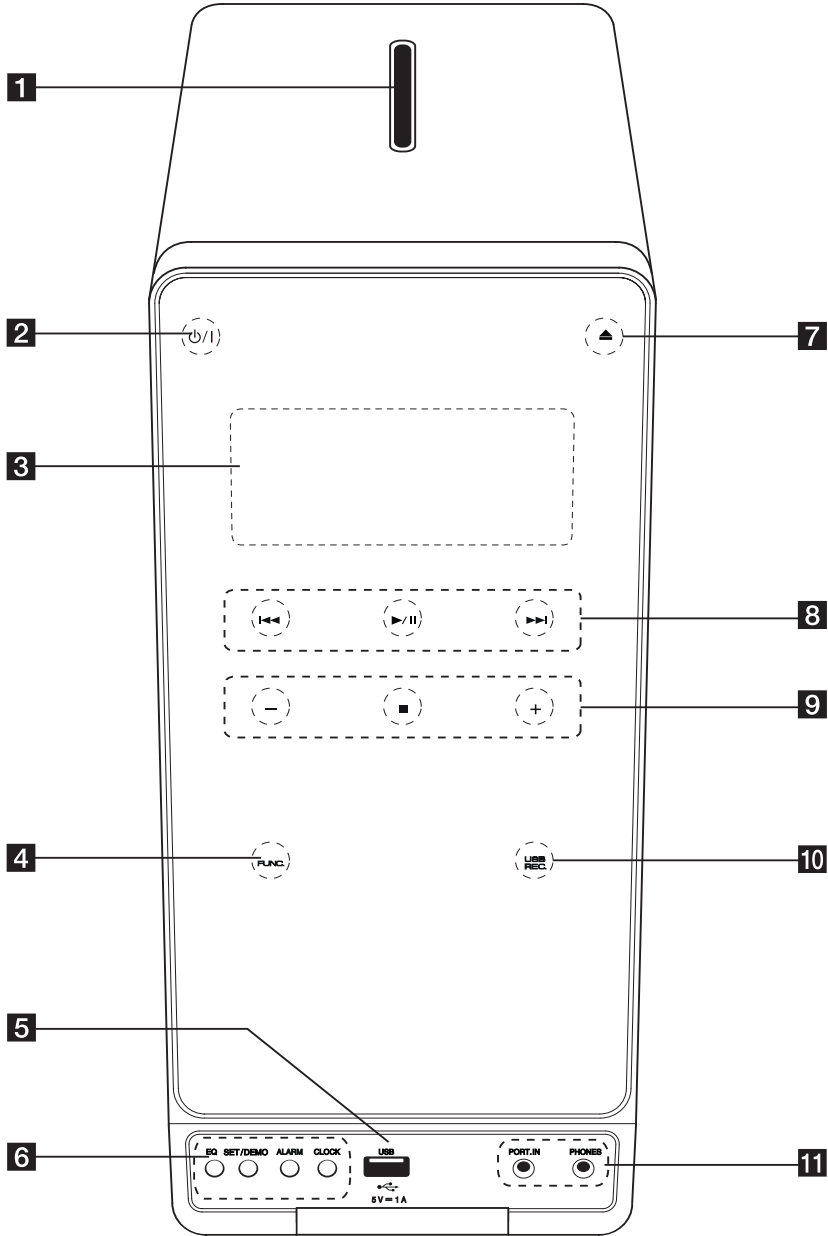



- 1** **Disc Slot**  
Insert a disc in the disc slot with the label side left.
- 2** **⏻ / I (POWER)**  
Switches the unit ON or OFF.
- 3** **Display window**  
Shows the current status of the unit.
- 4** **FUNC. (FUNCTION)**  
Changes the input source or function.
- 5** **USB Port**  
Connects an USB device.
- 6** **EQ**  
Chooses sound impressions.  
**SET/DEMO**  
- Confirms the setting.  
- Show DEMO.  
**ALARM**  
With the ALARM function you can turn CD, USB play and TUNER reception on at a desired time.  
**CLOCK**  
For setting the clock and checking the time.
- 7** **⏏ (OPEN/CLOSE)**  
Ejects or insert the disc from slot loader.
- 8** **⏮/⏭ (Skip/Search):**  
Goes to next or previous file/track.  
Searches backward or forward (Press and hold)  
Tunes in the desired radio station.  
**▶/⏸ (PLAY / PAUSE)**  
Starts playback.  
Pauses playback temporarily, press again to exit pause mode.  
Selects stereo/mono in FM mode.
- 9** **+ / - (VOLUME)**  
Adjusts speaker volume.  
**■ (STOP)**  
Stops playback.
- 10** **USB REC.**  
Recoding to USB.
- 11** **PORT. IN**  
Connects to a portable player with audio outputs.  
**PHONES**  
Listens to music with your headphone.(3.5 mm)

 **Caution**

Precautions in using the touch buttons

- Use the touch buttons with clean and dry hands.  
- In a humid environment, wipe out any moisture on the touch buttons before using.
- Do not press the touch buttons hard to make it work.  
- If you apply too much strength, it can damage the sensor of the touch buttons.
- Touch the button that you want to work in order to operate the function correctly.
- Be careful not to have any conductive material such as metallic object on the touch buttons. It can cause malfunctions.

1

Getting Started

# Rear Panel

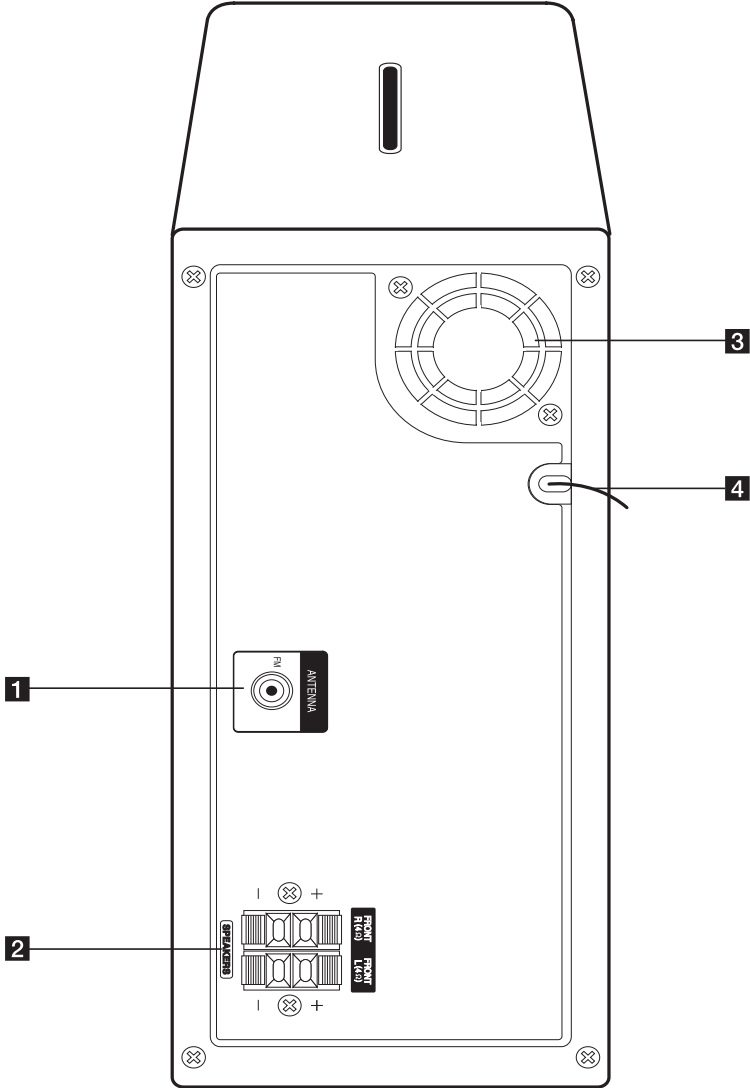

- 1 ANTENNA (FM)**  
Connects the FM wired antenna.
- 2 SPEAKERS** terminal

- 3** Cooling fan
- 4** Power cord

## Remote Control

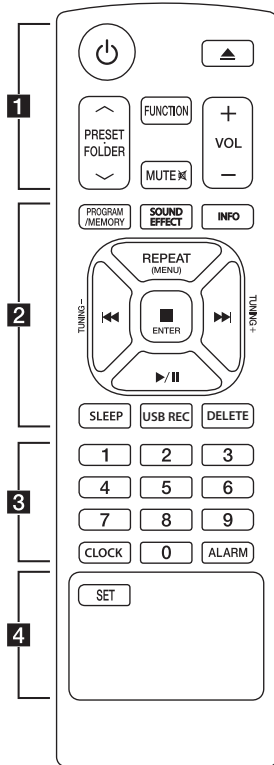

### Battery Installation

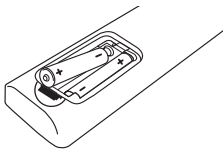

Remove the battery cover on the rear of the Remote Control, and insert two (size AAA) batteries with **+** and **-** matched correctly

..... **1** .....

**⏻ (Power)**: Switches the unit ON or OFF.

**⏏ (Open/Close)**: Ejects the disc from slot loader.

**PRESET FOLDER  $\wedge$  /  $\vee$** :

- Searches for a folder of MP3/WMA/FLAC files. When a CD/USB containing MP3/WMA/FLAC files in several folders is being played, press PRESET FOLDER  $\wedge$  /  $\vee$  to select the folder you want to play.
- Chooses a preset number for a radio station.

**FUNCTION**: Selects the function and input source.

**MUTE  $\times$** : Mutes the sound.

**VOL  $+$  /  $-$** : Adjusts speaker volume.

..... **2** .....

**PROGRAM/MEMORY**:

- Stores radio stations.
- Creates a playlist you want to listen to.

**SOUND EFFECT**: Chooses sound impressions.

**INFO**: Sees information about your music. MP3 files often come with ID3 tags. The tag gives the Title, Artist, Album or Time information.

**REPEAT (MENU)**: Listens to your tracks/files repeatedly or randomly.

**⏮ / ⏭ (Skip/Search)**:

- Skips Fast backward or Forward.
- Searches for a section within a track/file.

**TUNING  $-$  /  $+$** :

Selects the radio stations.

..... **3** .....

**ENTER**:

- Stops playback or recording.
- Cancels DELETE function.

**▶ / ⏸ (Play/Pause)**:

- Starts or pauses playback.

**SLEEP**: Sets the system to turn off automatically at a specified time. (Dimmer: The display window will be darkened by half.)

**USB REC**: Starts recording

**DELETE**: Deletes MP3/WMA/FLAC files. (USB only)

..... **4** .....

**0 to 9 numerical buttons**:

Selects numbered tracks, files, or preset number.

**CLOCK**: Sets a clock and checks a time.

**ALARM**: Uses your player as an alarm clock.

..... **4** .....

**SET**

Confirms the setting.

## Connecting to speakers

2

Connecting

### Attaching the speakers to the unit

To connect the cable to the unit, press each plastic finger pad to open the connection terminals on the unit. Insert the wire and release the finger pad.

Connect the black stripe of each wire to the terminals marked - (minus) and the other end to the terminals marked + (plus).

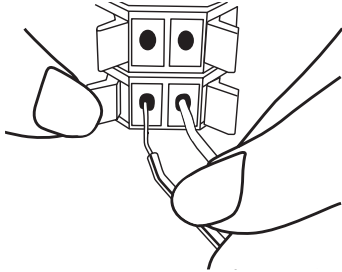

#### ! Caution

The speakers contain magnet parts, so color irregularity may occur on the TV screen or PC monitor screen. Please use the speakers far away from either TV screen or PC monitor.

## Antenna Connection

Connect the supplied FM antenna for listening to the radio.

Connect the FM wire antenna to the FM antenna connector.

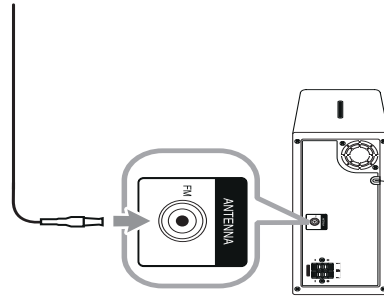

#### ! Note

Be sure to fully extend the FM wire antenna.

## Optional Equipment Connection

### USB Connection

Connect the USB port of USB Memory to the USB port on the unit.

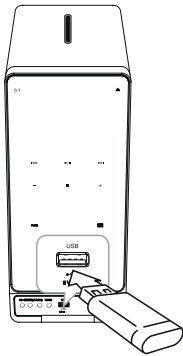

#### ! Note

Removing the USB Device from the unit

1. Choose a different function/mode or press **□** on the unit or **■ENTER** on the remote control.
2. Remove the USB device from the unit.

### PORT. IN Connection

The unit can be used to play the music from many types of external device. (Portable cable is not supplied as an accessory with this unit.)

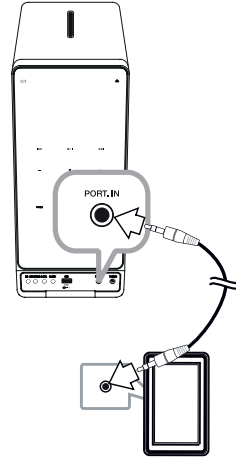

1. Connect the portable player to the **PORT. IN** connector of the unit.
2. Turn the power on by pressing **⏻/I**.
3. Select the PORTABLE function by pressing **FUNC.** on the unit or **FUNCTION** on the remote control.
4. Turn on the portable player or external device and start it playing.

## PHONES Connection

Connect a pair of stereo headphones ( $\varnothing$  3.5 mm phone plug) to PHONES jack on the unit for private listening. (Headphones are not supplied as an accessory with this unit.)

2

Connecting

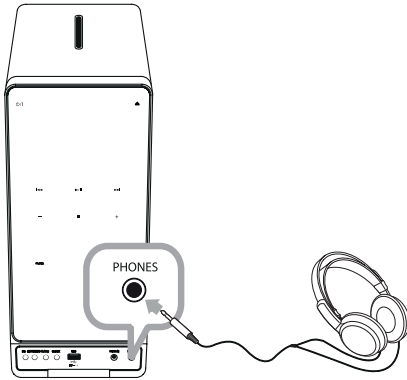

**Note**

You can't hear any sound from speakers, while the headphones plug is inserted in the PHONES jack.

# Basic Operations

## CD/USB Operations

1. Insert a disc by pressing ▲ or connect the USB device to the USB port.
2. Select the CD or USB function by pressing Press **FUNC.** on the unit or **FUNCTION** on the remote control.
3. Select a track/file you want to play by pressing ◀◀/▶▶ on the unit or the remote control.

To	Do this
Stop	Press ■ on the unit or ■ENTER on the remote control.
Playback	Press ▶/II.
Pause	During playback, Press ▶/II.
Skipping to the next/previous track/ file	During playback, press ▶▶ to go to the next track/file.
	Playing less than 2 seconds, press ◀◀ to go to the previous track/ file. Playing after 3 seconds, press ◀◀ to go to the beginning of the track/ file.
Searching for a section within a track/ file	Press and hold ◀◀/▶▶ during playback and release it at the point you want to listen to.
Searching for a section within a folder	Press <b>PRESET FOLDER</b> ▲/▼ on the remote control.
Playing repeatedly or randomly	Press <b>REPEAT(MENU)</b> on the remote control repeatedly, the display window will be changed in the following order, RPT1 -> RPT DIR (only MP3/WMA/FLAC) -> RPT ALL -> RANDOM -> OFF

**Note**

Music CDs or CD-R/CD-RW in music CD format can be only played.(12 cm disc)

## Android device Operation

You can enjoy the sound from your Android device through USB port. For details about Android device, refer to the Android device User Guide.

To stream audio from your Android device through this unit, you need :

- With Android operation system : Ver 4.1(or later) and AOA 2.0 (or later)
- With a micro USB cable

**Note**

It is possible that certain devices may not support or be compliant with the AOA2.0 USB audio standard, resulting in the device freezing or rebooting after being connected and detached from the speaker system.

If you experience this problem, please contact your device manufacturer. Your device may need to be updated with the latest Jellybean software and or the correct AOA2.0 USB audio standard.

You can recommended to remove the case for your Android device (Ver 4.1 or later) before you connect your Android device to USB port using a cable.

\*About AOA (Android Open Accessory) 2.0 version ;  
Audio output from Android device to the Accessory and HID (Human Interface Device)

1. Connect Android device to the USB port by using the Android device's cable.

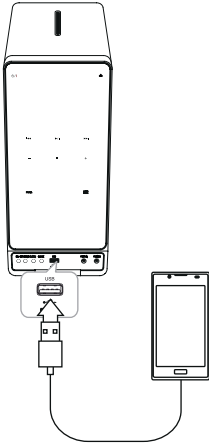

2. Press **FUNC.** on the unit or **FUNCTION** on the remote control to select USB function.
3. If your unit is connected firmly, 'ANDROID' will appear in the display window. You can operate your Android device through an Android device's display by using the remote control and controlling your Android device.

To	Do this
Play	Press ►/II.
Pause	During playback, press ►/II.
Skip	During playback, press ◀◀/▶▶ to go to the next file or to return to the beginning of the current file. During playback, press ◀◀ twice briefly to step back to the previous file.

When you selects USB function, you can see messages as follows;

Message	Cause
USB	Your device is not supported by AOA 2.0(Only charging)
Number of files	This unit recognizes your USB.
ANDROID	This unit recognizes your Android device supported by AOA 2.0 as known device.
NO USB	Any device is not connected to USB port. This unit recognizes your Android device as an unknown device.

**Note**

Depending on the type of device, Message will appear in other way.



### ! Note

- If the connection has an error, check these problems as follows;
  - Your Android device is not connected firmly.
  - This unit recognizes your Android device as an unknown device.
  - Your Android device is not booted.
  - Check the settings method of USB connection for Android devices. Some Android devices in the state of charge you can not work AOA.
- In case of no sound from this unit, adjust the volume of your Android device.
- The charging time may vary depending on your Android device.
- Some Android devices may not be charged.
- You may not control your Android device from this unit due to malfunction of Android device.
- Depending on your Android device's software version, it may not be possible to control your Android device from this unit. We recommend installing the latest software version.
- If your Android device does not support AOA (Android Open Accessory) 2.0 version, this unit can only charge your Android device even though Android device has OS 4.1 (or later).
- If you use an application, make a call, or send and receive SMS text message, etc. on Android device, disconnect it from this unit and then use it.
- Disconnect your device from USB port in case of malfunction, although the device's O/S is ver 4.1 (or later).
- Android devices are disconnected during playback, even though Android devices may continue to play.

### ! Note

- USB connection method may appear on the Android device when connecting this unit.
- Unplug the power cable or removing Android device from the unit can cause this unit may malfunction during operating the unit after connecting the Android device to the unit.
- Operate the Android devices after Android device is connected to this unit.
- In the case of some Android devices when you connect the unit and the unit may cause malfunction.
- AOA may not operate smoothly, depending on the settings on Android devices.
- This unit might not recognize Android devices properly when connected or disconnected to the device. Also, Android devices may stop or not operate normally. In this case, reboot the Android device or disconnect it from the unit and try again.

## Using a Bluetooth wireless technology

### About Bluetooth

**Bluetooth®** is wireless communication technology for short range connection.

The sound may be interrupted when the connection is interfered by the other electronic wave or you connect the bluetooth in the other rooms.

Connecting individual devices under **Bluetooth®** wireless technology does not incur any charges. A mobile phone with **Bluetooth®** wireless technology can be operated via the Cascade if the connection was made via **Bluetooth®** wireless technology.  
Available Devices : Mobile phone, MP3, Laptop, PDA.

### Bluetooth Profiles

In order to use **Bluetooth** wireless technology, devices must be able to interpret certain profiles. This unit is compatible with following profile.

A2DP (Advanced Audio Distribution Profile)

## Listening to music of a Bluetooth device

Before you start the pairing procedure, make sure the Bluetooth feature is turned on in to your Bluetooth device. Refer to your Bluetooth device's user guide. Once a pairing operation is performed, it does not need to be performed again.

1. Select the Bluetooth function by using the Press **FUNC.** on the unit or **FUNCTION** on the remote control. "BT READY" appears in the display window.
2. Operate the Bluetooth device and perform the pairing operation. When searching for this unit with the Bluetooth device, a list of the devices found may appear in the Bluetooth device display depending on the type of Bluetooth device. Your unit displays as "LG MICRO(XX:XX)".

#### ! Note

XX:XX means the last four digits of BT address. For example, if your unit has a BT address such as 9C:02:98:4A:F7:08, you will see "LG MICRO (F7:08)" on your Bluetooth device.

3. Enter the PIN code.  
PIN code : 0000
4. When this unit is successfully paired with your Bluetooth device, "BT PAIRED" appears in the display window.

#### ! Note

Depending on the Bluetooth device type, some devices have a different pairing way.

5. Listening to music.  
To play a music stored on your Bluetooth device, refer to your Bluetooth device's user guide. According to your Bluetooth device's volume level, the volume level of Bluetooth will be adjusted.

#### ! Note

- Sound from the main set can be distorted if you raise the volume of Bluetooth device up to two-thirds or more.
- When you use the Bluetooth function, adjust the volume of a Bluetooth device to a proper level to listen to.

**Note**

- When using Bluetooth® technology, you have to make a connection between the unit and the bluetooth device as close as possible and keep the distance. However it may not work well in the case below :
  - There is a obstacle between the unit and the bluetooth device.
  - There is a device using same frequency with **Bluetooth®** technology such as a medical equipment, a microwave or a wireless LAN device.
- You should connect your Bluetooth device to this unit again when you restart it.
- The sound may be interrupted when the connection interfered by the other electronic wave.
- You cannot control the Bluetooth device with this unit.
- Pairing is limited one Bluetooth device per one unit and multi-pairing is not supported.
- Depending on the type of the device, you may not be able to use the Bluetooth function.
- You can enjoy wireless system using phone, MP3, Notebook, etc..
- When not connected the Bluetooth, "BLUETOOTH" and "BT READY" appears on the control panel.
- When someone stands and interrupts communication between Bluetooth device and the player, the connection will be disconnected.
- The more distant between the unit and the bluetooth device, the lower the sound quality becomes.
- When Bluetooth connection is disconnected, connect the bluetooth device to the unit again.
- Bluetooth connection will be disconnected when the unit is turned off or the bluetooth device gets far from the unit.
- After your device is connected to the unit via Bluetooth, the function switches to BT automatically. But while recording, it doesn't switch to BT.

## Using Bluetooth App

### ! Note

Only Android OS is available to use "LG Bluetooth Remote" app with this unit.

### About "LG Bluetooth Remote" App

"LG Bluetooth Remote" app brings a suite of new features to this unit.

To enjoy more features, you are recommended to download and install free "LG Bluetooth Remote" app.

### Install "LG Bluetooth Remote" App onto Your Bluetooth Device

There are two ways to install "LG Bluetooth Remote" App onto Your Bluetooth Device.

#### Install "LG Bluetooth Remote" App through QR code

1. Install "LG Bluetooth Remote" app through QR code. Use the scanning software to scan the QR code.



2. Tap an icon for installation.
3. Tap an icon for downloading.

### ! Note

- Make sure that your Bluetooth device is connected to the Internet.
- Make sure that your Bluetooth device has a scanning software application. If you don't have one, download one from "Google Android Market (Google Play Store)".

### Install "LG Bluetooth Remote" App through "Google Android Market (Google Play Store)"

1. Tap the "Google Android Market (Google Play Store)" icon.
2. In the search bar, type in the "LG Bluetooth Remote" and search it.
3. In the search result list, find and tap "LG Bluetooth Remote" to start downloading Bluetooth app.
4. Tap an icon for installation.
5. Tap an icon for downloading.

### ! Note

- Make sure that your Bluetooth device is connected to the Internet.
- Make sure that your Bluetooth device is equipped with "Google Android Market (Google Play Store)".

## Activate Bluetooth with “LG Bluetooth Remote” App

“LG Bluetooth Remote” app helps to connect your bluetooth device to this unit.

1. Tap “LG Bluetooth Remote” app icon on the home screen to open “LG Bluetooth Remote” app, and go to the main menu.
2. Tap [Setting] and select the unit you want.
3. If you want to get more information to operate, tap [Setting] and [Help].

### Note

- “LG Bluetooth Remote” app will be available in the software version as follow;
  - Android O/S : Ver 2.3.3 (or later)
- This unit does not support the multi-pairing. If this unit is already connected with other Bluetooth device, disconnect that device and then try again.
- If you use “LG Bluetooth Remote” app for operation, there would be some differences between “LG Bluetooth Remote” app and the supplied remote control. Use the supplied remote control as necessary.
- Depending on the Bluetooth device, “LG Bluetooth Remote” app may not work.
- The connection you’ve made may be disconnected if you select other application or change the setting of the connected device via “LG Bluetooth Remote” app. In such a case, please check the connection status.
- After connection of “LG Bluetooth Remote” app, music may be output from your device. In this case, try connecting procedure again.

## Radio Operations

### Listening to the radio

1. Press **FUNCTION** or **FUNC.** until FM appears in the display window.  
The last received station is tuned in.
2. Auto tuning : Press and hold **◀◀/▶▶** on the unit or **TUNING -/+** on the remote control for about 2 seconds until the frequency indication starts changing, then release. Scanning stops when the unit tunes in a station.  
Manual tuning : Press **◀◀/▶▶** on the unit or **TUNING -/+** on the remote control repeatedly.
3. Adjust the volume by pressing **VOL+/-**.

### Improving poor FM reception

Press **▶/II**. This will change the tuner from stereo to mono. Then the reception will be better than before.

### Presetting the Radio Stations

You can preset 50 stations for FM.  
Before tuning, make sure to turn down the volume.

1. Press **FUNCTION** or **FUNC.** until FM appears in the display window.
2. Select the desired frequency by pressing **◀◀/▶▶** on the unit or **TUNING -/+** on the remote control.
3. Press **PROGRAM/MEMORY** on the remote control. A preset number will blink in the display window.
4. Press **PRESET FOLDER ^/V** on the remote control to select the preset number you want.
5. Press **PROGRAM/MEMORY**. The station is stored.
6. Repeat steps 2 to 5 to store other stations.
7. To listen a preset station, press **PRESET FOLDER ^/V**.

### Deleting all the saved stations

1. Press and hold **PROGRAM/MEMORY** on the remote control for two seconds. "ERASE ALL" will blink on the display window.
2. Press **PROGRAM/MEMORY** to erase all saved radio stations.

## Other Operations

### Programmed Playback

The program function enables you to store your favorite files from any disc or USB device.

A program can contain 20 tracks/files.

1. Insert a CD or connect USB and wait for it to be loaded.
2. Press **PROGRAM/MEMORY** on the remote control in stop state.
3. Press **◀◀/▶▶** to select a next track/file.
4. Press **PROGRAM/MEMORY** again to save and select a next track/file.
5. Press **▶/||** to play the programmed music tracks/files.
6. To clear your selection, press **■ENTER** twice in a row.

#### ! Note

The programs are also cleared when the disc or USB device is removed, the unit is powered off or the function is switched to others.

### Displaying file information

While playing an MP3 file containing file information, you can display the information by pressing **INFO** on the remote control.

### Turn off the sound temporarily

Press **MUTE**  on the remote control to mute your sound.

You can mute the sound in order, for example, to answer the telephone. the mute symbol "M" will appear in the display window.

To cancel mute function, press **MUTE**  again or adjust volume level by pressing **VOL+** / **-**.

### DEMO

In power off state, press **SET/DEMO** on the unit once. The unit will power on and display the each of functions in the display window. To cancel DEMO function, press **SET/DEMO** again.

#### ! Note

- While DEMO, this unit will keep DEMO status even if you unplug the power cord connection.
- You can enjoy other functions during the DEMO. Then the DEMO will pause to temporary.
  - Without input key in 10 sec, the DEMO will play back automatically.

## Selecting a folder and an MP3/WMA/FLAC file

1. **PRESET FOLDER**  $\wedge$ /**V** on the remote control repeatedly until a desired folder appears.
2. Press **▶/||** to play it. The first file of folder will be played. (During playback, if you selecting a folder you want, this step is not necessary.)

### Note

- CD / USB Folders/Files are recognized as below.

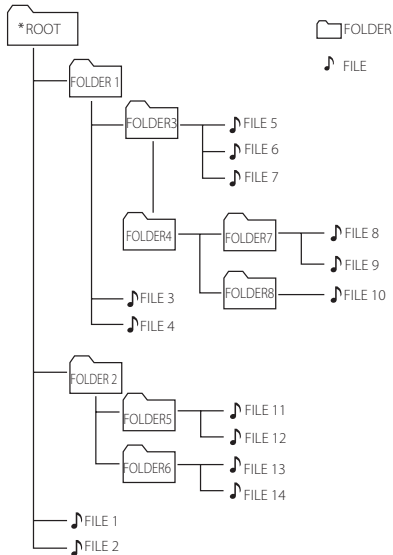

- If there is no file in a folder, the folder will not appear
- Folders will be presented as the following order;  
ROOT  $\rightarrow$  FOLDER1  $\rightarrow$  FOLDER3  $\rightarrow$  FOLDER7  $\rightarrow$  FOLDER8  $\rightarrow$  FOLDER5  $\rightarrow$  FOLDER6
- File will be played from  $\wedge$  file No.1 to  $\wedge$  file No.14 one by on.
- Files and folders will be presented in order recorded and may be presented differently according to the record circumstances.
- \*ROOT : the first screen you can see when a computer recognize the CD/USB is "ROOT".

## Deleting an MP3/WMA/FLAC file

You can delete file, folder or format by pressing **DELETE** on the remote control. This function is supported only in stop state. (USB only)

1. -Select the file you want to delete by using **◀◀/▶▶**. And press **DELETE**.

-Select the folder you want to delete by pressing **PRESET FOLDER**  $\wedge$ /**V** on the remote control. Then press **DELETE**.

-Press and hold **DELETE** to format the USB device.

Or

Press **DELETE** repeatedly while searching a file.

The display window will be changed in the following order.

- DEL FILE? : Deletes file
- DEL FOLDER : Deletes folder
- FORMAT? : Formats USB

2. To delete file/folder or format, press **▶/||**.
3. If you want to exit the current mode, Press  $\blacksquare$  on the unit or **ENTER** on the remote control.

### Caution

- Do not extract the USB device during operation. (play, delete, etc.)
- Regular back up is recommended to prevent data loss.
- The delete function may not be supported according to the USB state. (lock, etc.)



## Sound adjustment

### Setting the sound mode

This system has a number of pre-set surround sound fields. You can select a desired sound mode by using **EQ** on the unit or **SOUND EFFECT** on the remote control.

The displayed items for the Equalizer may be different depending on sound sources and effects.

On Display	Description
NATURAL	You can enjoy comfortable and natural sound.
AUTO EQ	Sets the sound equalizer on the mode that is the most similar to the genre which is included in the MP3 ID3 tag of song files.
POP CLASSIC JAZZ ROCK	This program lends an enthusiastic atmosphere to the sound, giving you the feeling you are at an actual rock, pop, jazz or classic concert.
MP3 -- OPT	This function is optimized for compressible MP3 file. It improves the treble sound.
BASS BLAST	Reinforces the treble, bass and surround sound effect.
LOUDNESS	Improves the bass and treble sound.
BYPASS	You can enjoy the sound without equalizer effect.

#### Note

Maybe you need to reset the sound mode, after switching the input, sometimes even after the sound track/file is changed.

## Setting the Clock

1. Turn the unit on.
2. Press and hold **CLOCK**.
3. Select time mode by pressing **◀◀/▶▶** on the remote control.
  - AM 12:00 (for an AM and PM display) or 0:00 (for a 24 hour display)
4. Press **SET/DEMO** on the unit or **SET** on the remote control to confirm your selection.
5. Select the hours by pressing **◀◀/▶▶** on the remote control.
6. Press **SET/DEMO** on the unit or **SET** on the remote control.
7. Select the minutes by pressing **◀◀/▶▶** on the remote control.
8. Press **SET/DEMO** on the unit or **SET** on the remote control.

### Setting the Clock through "LG Bluetooth Remote" App

Install "LG Bluetooth Remote" app on your Android device. (see page 20 - 21)

Your unit's clock will be automatically synchronized with your device by activating Bluetooth connection through "LG Bluetooth Remote" app.

## Using your player as an alarm clock

1. Turn the unit on.
2. Press and hold **ALARM**.
3. Press **◀◀/▶▶** on the remote control to change the hours and minutes and Press **SET/ DEMO** on the unit or **SET** on the remote control to save.
4. Press **◀◀/▶▶** on the unit to select function and press **SET** to save.
5. Press **◀◀/▶▶** on the remote control to change the volume and Press **SET/DEMO** on the unit or **SET** on the remote control to save. The clock icon "⌚" shows that the alarm is set.

### ! Note

- If you set the clock time, you can check the time by pressing **CLOCK** even when the player is turned off.
- If you set the clock time and alarm, you can check the alarm icon "⌚" by pressing **CLOCK** even when the player is turned off.
- If you set the clock time and alarm, you can check the alarm icon "⌚" and setting information by pressing **ALARM** even when the unit is turned off.
- Press **ALARM**, you can select a **ALARM** on / off mode.
- If the alarm rings with USB cable connected to USB port, the function switches to tuner function. (Depending on the type of device, this may not be available.)

## Sleep Timer Setting

Press **SLEEP** repeatedly to select delay time between 10 and 180 minutes. After delay time, the unit will turn off. (You can see the following order, 180 -> 150 -> 120 -> 90 -> 80 -> 70 -> 60 -> 50 -> 40 -> 30 -> 20 -> 10)

To cancel the sleep function, press **SLEEP** repeatedly until the display window get bright.

### ! Note

- Press **SLEEP**. The remaining time appears in the display window.
- Sleep function will work after dimmer function.

## Dimmer

Press **SLEEP** once. The display window will be darkened by half. To cancel it, press **SLEEP** repeatedly until the display window get bright.

## Auto Power Down

This unit will power off itself to save electric consumption in the case main unit is not connected to external device and is not used for 20 minutes.

This unit will power off after six hours when connected to a device using an analog input.

# Advanced Operation

## Recording on USB

You can record a various sound source to USB. (CD, PORTABLE, FM)

1. Connect the USB device to the unit.
2. Select a function by pressing **FUNCTION** or **FUNC.**  
 One track/file recording - You can record a track/ a file on USB while playing the file you want.  
 All tracks/files recording - You can record tracks/ files on USB in stop state.  
 Program list recording - After making program list, you can record it on USB.  
 (Refer to the page 23)
3. Start the recording by pressing **USB REC.** on the unit or **USB REC** on the remote control.
4. To stop recording, press **■ENTER.**

## Pausing recording

During recording, press **USB REC.** on the unit or **USB REC** on the remote control to pause recording. Press it again to restart recording. (Only Radio/ Portable function)

## To select recording bit rate and speed

1. Press **USB REC.** on the unit or **USB REC** on the remote control. for longer than 3 seconds.
2. Use **◀◀/▶▶** to select the bit rate.
3. Press **USB REC.** on the unit or **USB REC** on the remote control. again to select the recording speed.
4. Press **◀◀/▶▶** to select a desired recording speed. (Audio CD Only)

### X1 SPEED

- You can listen to music while recording it.

### X2 SPEED

- You can just record the music file.

5. Press **USB REC.** on the unit or **USB REC** on the remote control. to finish the setting.

## ! Note

- It is not supported to record music stored on bluetooth device.
- You can check the recording percentage rate for the USB record on the display window during the recording. (MP3/WMA/FLAC CD Only)
- During recording MP3/WMA/FLAC, there is no sound.
- When you stop recording during playback, the file that has been recorded at that time will be stored. (Except for MP3/WMA/FLAC files)
- Do not remove the USB device or turn off the unit during USB recording. If not, an incomplete file may be made and not deleted on PC.
- If USB recording does not work, the message like "NO USB", "ERROR(USB ERR)", "FULL(USB FULL)", "NO SUPPORT" or "NO REC" is displayed on the display window.
- Multi card reader device, External HDD, mobile phone can not be used for USB recording.
- A file is recorded by about 512 Mbyte when you record for a long term.
- You may not store more than 999 files.
- It'll be stored as follows.

AUDIO CD	MP3/WMA/FLAC	The other source*
<ul style="list-style-type: none"> <li>■ CD_REC</li> <li>├ TRK_001</li> <li>├ TRK_002</li> <li>├ ⋮</li> </ul>	<ul style="list-style-type: none"> <li>■ FILE_REC</li> <li>├ ABC(File name)</li> <li>├ DEF(File name)</li> <li>├ ⋮</li> </ul>	<ul style="list-style-type: none"> <li>■ EXT_REC</li> <li>├ AUDIO_001</li> <li>├ AUDIO_002</li> <li>├ ⋮</li> </ul>

\* : FM, PORTABLE and the like.

The making of unauthorized copies of copy-protected material, including computer programs, files, broadcasts and sound recordings, may be an infringement of copyrights and constitute a criminal offense. This equipment should not be used for such purposes.

**Be responsible  
Respect copyrights**

## Troubleshooting

Problem	Correction
No Power.	<ul style="list-style-type: none"> <li>• Plug in the power cord.</li> <li>• Check the condition by operating other electronic devices.</li> </ul>
No sound.	<ul style="list-style-type: none"> <li>• Press <b>FUNCTION</b> or <b>FUNC.</b> and check the selected function.</li> <li>• If not, connect speaker cables correctly. Speaker cables connected correctly.</li> </ul>
The unit does not start playback.	<ul style="list-style-type: none"> <li>• Insert a playable disc.</li> <li>• Clean the disc. (Refer to the 31 page)</li> <li>• Insert the disc with the label or printed side facing upward.</li> </ul>
Radio stations cannot be tuned in properly.	<ul style="list-style-type: none"> <li>• Connect the antenna securely.</li> <li>• Tune to the station manually.</li> <li>• Preset some radio stations, see page 22 for details.</li> </ul>
Android device does not work.	<ul style="list-style-type: none"> <li>• Check whether your device's O/S is ver 4.1 (or later) or AOA 2.0 (or later).</li> <li>• Connect your Android device using USB cable firmly.</li> </ul>
The remote control does not work properly.	<ul style="list-style-type: none"> <li>• Operate the remote control within about 7 m.</li> <li>• Remove the obstacle in the path of the remote control and the unit.</li> <li>• Replace the batteries with new ones.</li> </ul>
Clock is not displayed.	Connect your Bluetooth device to your unit through "LG Bluetooth Remote" app for time sync.

## Trademarks and Licenses

---



*Bluetooth*® wireless technology is a system which allows radio contact between electronic devices.

Connecting individual devices under *Bluetooth*® wireless technology does not incur any charges.

A mobile phone with *Bluetooth*® wireless technology can be operated via the Cascade if the connection was made via *Bluetooth*® wireless technology.

The *Bluetooth*® word mark and logos are owned by the *Bluetooth*® SIG, Inc. and any use of such marks by LG Electronics is under license.

Other trademarks and trade names are those of their respective owners.

---

## Specifications

General	
Power supply	Refer to the main label.
Power consumption	Refer to the main label.
Dimensions (W x H x D)	(135 x 295 x 315) mm
Net Weight (Approx.)	3.7 kg
Operating temperature	5 °C to 35 °C (41 °F to 95 °F)
Operating humidity	5 % to 90 %
Bus Power Supply	5 V  1 A

Inputs	
PORT. IN	0.5 Vrms (3.5 mm stereo jack)

Tuner	
FM Tuning Range	87.5 MHz to 108.0 MHz or 87.50 MHz to 108.00 MHz

Amplifier	
Stereo mode	80 W + 80 W
T.H.D	10 %

CD	
Frequency Response	30 to 20000 Hz
Signal-to-noise ratio	80 dB
Dynamic range	80 dB

Speakers	
Type	3 Way 4 Speaker
Impedance	4 Ω
Rated Input Power	80 W
Max. Input Power	160 W
Net Dimensions (W x H x D)	(126 x 295 x 315) mm
Weight (1EA)	3.62 kg

- Design and specifications are subject to change without notice.

## Maintenance

### Notes on Discs

#### Handling Discs

Never stick paper or tape on the disc.

#### Storing Discs

After playing, store the disc in its case. Do not expose the disc to direct sunlight or sources of heat and never leave it in a parked car exposed to direct sunlight.

#### Cleaning Discs

Do not use strong solvents such as alcohol, benzene, thinner, commercially available cleaners, or anti-static spray intended for older vinyl records.

## Handling the Unit

### When shipping the unit

Please save the original shipping carton and packing materials. If you need to ship the unit, for maximum protection, re-pack the unit as it was originally packed at the factory.

### Keeping the exterior surfaces clean

Do not use volatile liquids such as insecticide spray near the unit.

Wiping with strong pressure may damage the surface.

Do not leave rubber or plastic products in contact with the unit for a long period of time.

### Cleaning the unit

To clean the player, use a soft, dry cloth. If the surfaces are extremely dirty, use a soft cloth lightly moistened with a mild detergent solution. Do not use strong solvents such as alcohol, benzene, or thinner, as these might damage the surface of the unit.

### Maintaining the Unit

The unit is a high-tech, precision device. If the optical pick-up lens and disc drive parts are dirty or worn, the picture quality could be diminished. For details, please contact your nearest authorized service center.

