



**LG**

Life's Good

ENGLISH

OWNER'S MANUAL

# REFRIGERATOR- FREEZER

**Please read carefully the manual instruction and safety caution  
before operating your refrigerator and retain it for future reference**



# Table of Contents

Introduction	Important Safety Instruction	3
	Identification of Parts	10
Installation	Installation	11
	Starting	11
Operation	Temperature Control	12
	Hygiene Fresh	13
	Express Freezing	13
	Eco Friendly	14
	Self Test	14
	Door Alarm	14
	Lock	14
	On/Off	14
	Ice Making	15
	Defrosting	15
	Water Dispenser	16
	Sliding Shelf	17
	Pull Out Tray	18
Lamp Replacement	18	
Suggestion On Food storage	Storing Food	19
	Suggestion for energy saving	19
Care and Maintenance	General Information	20
	Cleaning	21
	Smart Diagnosis™	22
	Trouble Shooting	23
	It is normal...	25

## Important Safety Instruction

Keep ventilation openings, in the appliance enclosure or in the built-in structure, clear of obstruction.

Do not use mechanical devices or other means to accelerate the defrosting process, other than those recommended by the manufacturer.

Do not damage the sealed system or any piping in or within the refrigerator.

Do not use electrical appliances inside the food storage compartments of the appliance, unless they are of the type recommended by the manufacturer.

The refrigerant and insulation blowing gas used in the appliance require special disposal procedures. When disposal, please consult with service agent or a similarly qualified person.



This appliance contains a small amount of isobutane refrigerant (R600a), natural gas with high environmental compatibility, but it is also combustible. When transporting and installing the appliance, care should be taken to ensure that no parts of the refrigerating circuit are damaged. Refrigerant squirting out of the pipes could ignite or cause an eye injury. If a leak is detected, avoid any naked flames or potential sources of ignition and air the room in which the appliance is standing for several minutes.

In order to avoid the creation of a flammable gas air mixture if a leak in the refrigerating circuit occurs, the size of the room in which the appliance may be sited depends on the amount of refrigerant used. The room must be 1m<sup>2</sup> in size for every 8g of R600a refrigerant inside the appliance. The amount of refrigerant in your particular appliance is shown on the identification plate inside the appliance. Never start up an appliance showing any signs of damage. If in doubt, consult your dealer.

**This guide contains many important safety messages.  
Always read and obey all safety messages.**



This is the safety alert symbol. It alerts you to safety messages that inform you of hazards that can cause death or serious injury you or others or cause damage to the product. All safety messages will be preceded by the safety alert symbol and the hazard signal word WARNING, or CAUTION. These words mean:



**WARNING** Death, or serious injury can occur if you don't follow instructions.



**CAUTION** Indicates an imminently hazardous situation which, if not avoided, may result in minor or moderate injury, or product damage only.

All safety messages will identify the hazard, tell you how to reduce the chance of injury, and tell you what can happen if the instructions are not followed.

## WARNING

To reduce the risk of fire, electric shock, or injury to persons when using your product, basic safety precautions should be followed, including the following.

Read all instructions before using this appliance.

### 1. When connecting the power

**A dedicated outlet should be used.**

- Using several devices at one outlet may cause fire.
- If unit is connected to an earth leakage breaker it may trip resulting in spoiled food. This could occur due to power supply circumstances, and may not necessarily mean a refrigerator malfunction.

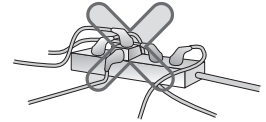

**Do not allow the power plug to face upward or to be crushed at the back of the refrigerator.**

If the cord is crushed behind the refrigerator it may damage the cable resulting in fire. An upward facing plug may pull loose under the weight of the cord resulting in electrical failure causing fire or the refrigerator turning off and spoiling food.

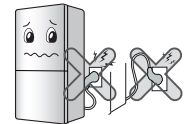

**Prevent the power cord from being crushed or kinked if the refrigerator is pushed in after the power plug is extracted during the installation.**

**When moving your appliance away from the wall, be careful not to roll over the power cord or to damage it in any way.**

Crushed or kinked cables can become the cause of fire or electric shock.

**Do not allow heavy objects to kink or crush the power cord.**

**It may damage the power cord and become a cause of fire or electric shock.**



**Do not extend or modify the length of the power plug.**

This may become the cause of fire or electric shock.



**Unplug the power plug when cleaning, handling or replacing the interior lamp of the refrigerator.**

**If the interior lighting is LED type, then it cannot be changed by the user. Please call an authorised Service provider or the manufacturer.**



- Not doing so may cause electric shock or injury.

**Do not pull out the cord or touch the power plug with wet hands.**

It may cause electric shock or injury.

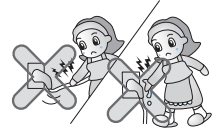

**Remove water or dust from the power plug and insert it with the ends of the pins securely connected.**

Dust, water or an unstable connection may cause fire or electric shock.

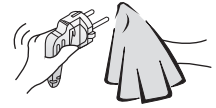

**Unplug the power cord from the power outlet for cleaning or other requirements.**

Not doing so may cause electric shock or injury.

**Do not disconnect by pulling on the cord. Always disconnect by grasping and pulling on the plug top.**

Pulling on the cable may damage the cable resulting in electric shock or fire.



**Make sure of grounding.**

**Consult a qualified electrician or service person if the grounding instructions are not completely understood, or if you have doubts on whether the appliance is properly grounded.**

Incorrect grounding may lead to electric shock in the event of a breakdown.

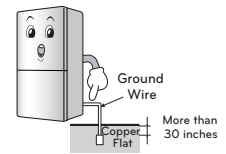

**Always have unit grounded in accordance with local regulations.**

**Be sure to use a properly grounded extension lead if an extension lead must be used.**

If incorrectly grounded it may become the cause of a fire.

**When the power cord or the power plug is damaged or the power outlet is loose or damaged, do not plug the power cord into the power outlet.**

Doing so may cause electric shock or be the cause of a fire.

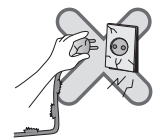

**If the mains plug is removed from the wall outlet for any reason, wait for 5 minutes or longer before reconnecting the plug.**

Not doing so may cause the operation of the refrigerator to fail.



**If the supply cord is damaged, it must be replaced by the manufacturer or its service agent or a similarly qualified person in order to avoid a hazard.**

## 2. When using the refrigerator

**Do not place heavy objects or liquid filled objects on the top of the refrigerator.**

Heavy objects may fall when opening and closing doors resulting in injury. Liquid filled objects may leak or fall and break resulting in injury, or electric shock.



**Do not install the refrigerator in a damp or wet environment.**

Moisture may penetrate electrical components resulting in fire or electric shock.



**This refrigerator is intended for normal domestic indoor use. It must not be used outdoors, or any sheltered outdoor area, direct sunlight, or stored in an out door location that is exposed to any weathering conditions.**

**Do not lean on or hang from the doors or shelves of the refrigerator.**

This will damage the doors and shelves of the refrigerator or cause it to topple over resulting in death, or serious injury and damage. Always supervise children when they are near the refrigerator.



**Never Allow children to enter or play inside the compartments of the product.**

It may endanger the life of a child if the child enters the refrigerator.

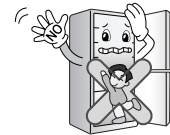

**Take care when opening and closing the refrigerator doors. Vigorous opening or closing may cause the contents to fall out resulting in injury or damage.**

**It is normal for the Freezer door to open if the refrigerator door is closed with excessive force.**

**Do not store or use Inflammable materials in or around the refrigerator.**

It may cause an explosion or fire.

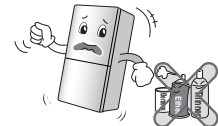

**Do not use or place heated or flame based scented products (Such as scented candles or incense burners) in or on the fridge to deodorise.**

It may cause an explosion or fire.



**Do not store medical supplies, temperature critical medicines, or scientific materials in the refrigerator.**

If materials with strict temperature restrictions are stored they may deteriorate or react undesirably resulting in possible harm or risk.



**Do not use any combustible spray near the refrigerator.**

It may cause an explosion or fire.



**Install in places away from the heat sources such as fireplaces, heaters and ovens. Pay particular attention to avoid locating near gas related products.**

Not doing so may become the cause of an explosion or fire.



**Do not place flower vases, cups, cosmetics, medicine or any container with water on the refrigerator.**

They may fall, leak or spill resulting in possible electric shock or fire.



**In case of a heavy electrical storm or if unit is not to be used for a long period of time, disconnect the power plug.**

There is a possibility of electrical damage. This may lead to an electric shock or fire.

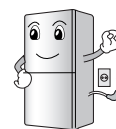

**DO NOT use a damaged unit until it has been certified safe by a licensed electrician or similarly qualified person.**

It may cause an electric shock or fire.

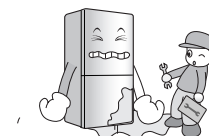

**If a gas leak is detected, do not touch the refrigerator or the outlet and ventilate the room immediately.**

- Any spark may result in an explosion or fire.
- Because this refrigerator uses natural gas (isobutene, R600a) as the environment-friendly refrigerant, even a small amount is combustible. If a gas leak occurs due to severe damage during delivery, installation or a sealed system malfunction, a spark may cause a fire.

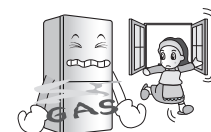



**Do not spray water on either the inside or outside of the refrigerator. Do not use alcohol or mineral based cleaners on the refrigerator (such as Benzene or Thinners).**

These may deteriorate or penetrate the insulation or electrical components resulting in possible electric shock, fire or damage to refrigerator.

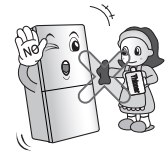

**When any strange smell or smoke is detected from the refrigerator, disconnect the power plug immediately and contact to the service center.**

Continuing to run unit may result in damage or fire.

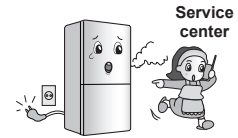

**Do not allow any person except a qualified engineer to disassemble, repair the refrigerator.**

It may cause injury, electric shock or fire.

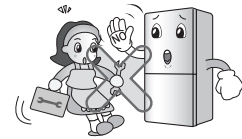

**Do not use the fridge-freezer for non-domestic purposes (storing medicine or testing material, or for use in a mobile application or for commercial purposes.)**

It may cause an unexpected risk such as fire, electric shock, deterioration of stored material or chemical reaction.

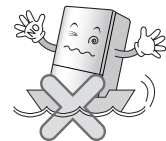

**When disposing the refrigerator, remove the door seals from the refrigerator but leave the shelves in place so that children may not easily climb inside.**

Failure to do so may cause a child to become trapped inside.



**This appliance is not intended for use by persons (including children) with reduced physical, sensory or mental capabilities, or lack of experience and knowledge, unless they have been given supervision or instruction concerning use of the appliance by a person responsible for their safety.**

**Children should be supervised to ensure that they do not play with the appliance.**

**Install the refrigerator on a solid and level floor.**

Installing it in an unstable place may cause death or serious injury by the refrigerator falling over when opening or closing the door.



**Do not insert hands or a metal object into the exit of cool air, the cover, the bottom of the refrigerator, the heatproof grill (exhaust hole) at the back.**

It may cause electric shock or injury.

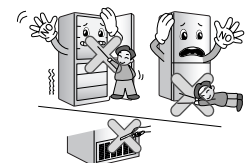

**Ensure that all foods and containers are stored or stacked in a stable manner.**

A container may fall during opening and closing of the door of the refrigerator and cause injury or breakages.

**Do not put filled bottles in the freezer.**

This will freeze the contents and break the bottle possibly resulting in injury.



**Do not insert hands into the bottom of the refrigerator.**

The iron plate at the bottom may cause injury.



**Carry the fridge-freezer with the handles at the bottom of the front and the top of the rear.**

Otherwise, your hands may slip possibly resulting in injury or product damage. Because the product is heavy, carrying it will require more than one person in order to avoid any possible injury.

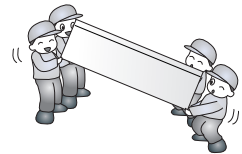

**Opening and closing the door of the refrigerator vigorously may cause the stored food in the refrigerator door baskets to fall and break and cause injury so take care when opening and closing the doors.**

## Identification of Parts

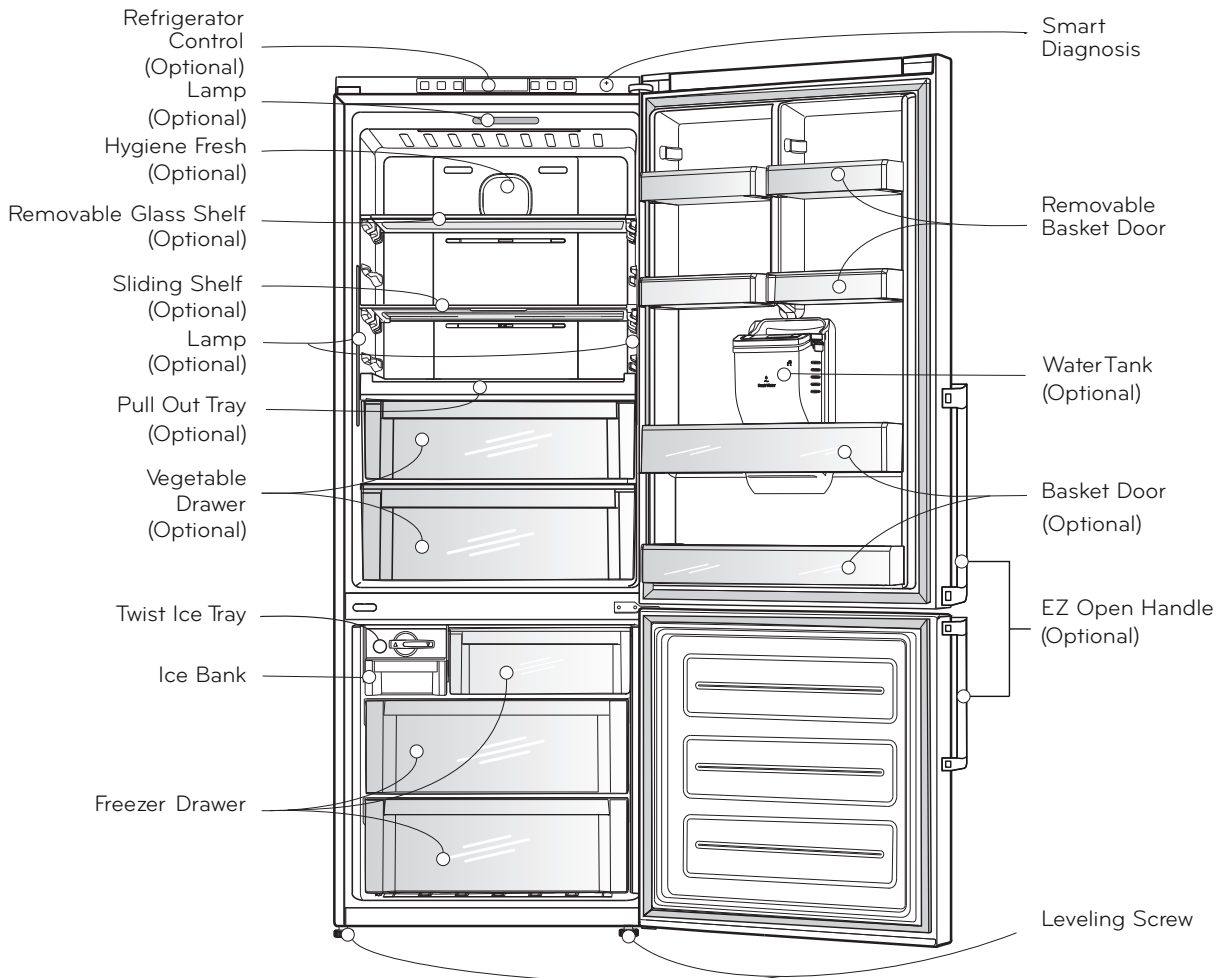

### Note

If you find some parts missing from your unit, they may be parts only used in other models.

## Installation

1. Select a good location.  
Place your fridge-freezer where it is easy to use.
2. Avoid placing the unit near heat sources, direct sunlight or moisture.  
Do not place in any outdoor sheltered location or where it can be exposed to environmental conditions.
3. To ensure proper air circulation around the fridge-freezer, please maintain sufficient space on both the sides as well as top and maintain at least 2 inches (5 cm) from the rear wall.

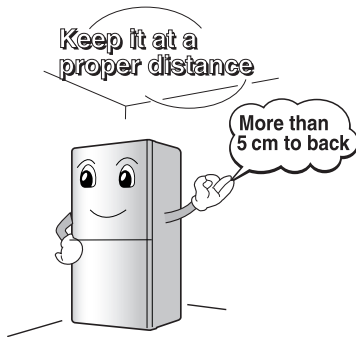

4. To avoid vibration, the unit must be leveled.  
If required, adjust the leveling screws to compensate for the uneven floor.  
The front should be slightly higher than the rear to aid in door closing.  
Leveling screws can be turned easily by tipping the cabinet slightly.  
Turn the leveling screws counterclockwise (↺) to raise the unit, clockwise (↻) to lower it.
5. Clean your fridge-freezer thoroughly and wipe off all dust which may have accumulated during shipping.
6. Install accessories such as ice cube box, etc., in their proper places. They are packed together to prevent possible damage during shipment.
7. Connect the power supply cord (or plug) to the outlet. Don't double up with other appliances on the same outlet.

## Appliance usage range

This appliance is intended to be used in household and similar applications such as:

- staff kitchen areas, offices and other domestic type environments.
- hotels, motels and other residential type environments;
- bed and breakfast type environments;

## Starting

When your refrigerator is installed, allow it 3-4 hours to stabilize at normal operating temperature prior to filling it with fresh or frozen foods.

If power plug is disconnected, allow 5 minutes delay before restarting.

Your refrigerator is now ready for use.

## Note

**Do not move refrigerator while the refrigerator is operating.**

Compressor may emit a temporary rattling noise. (This is normal and will not impact on the performance or the life of the compressor.

The rattling will stop, if the rattling sound does not stop after 1 minute, turn off the power, wait 5 minutes and then turn back on again.

## Climate class

The appliance is designed to operate at the limited range of ambient temperature, depending on climate zones. Do not use the appliance if the temperature out of the allowable limit. Climate class of your appliance is indicated on the label with technical description inside the fridge compartment

Class	Symbol	Ambient temperature range °C
Extended temperate	SN	+10 ~ +32
Temperate	N	+16 ~ +32
Subtropical	ST	+16 ~ +38
Tropical	T	+16 ~ +43

## Temperature Control

Your refrigerator has controls that let you regulate the temperature in the refrigerator and freezer compartments.

### Display Panel For Temperature Control

Adjusting the temperatures and functions

< Exterior Type >

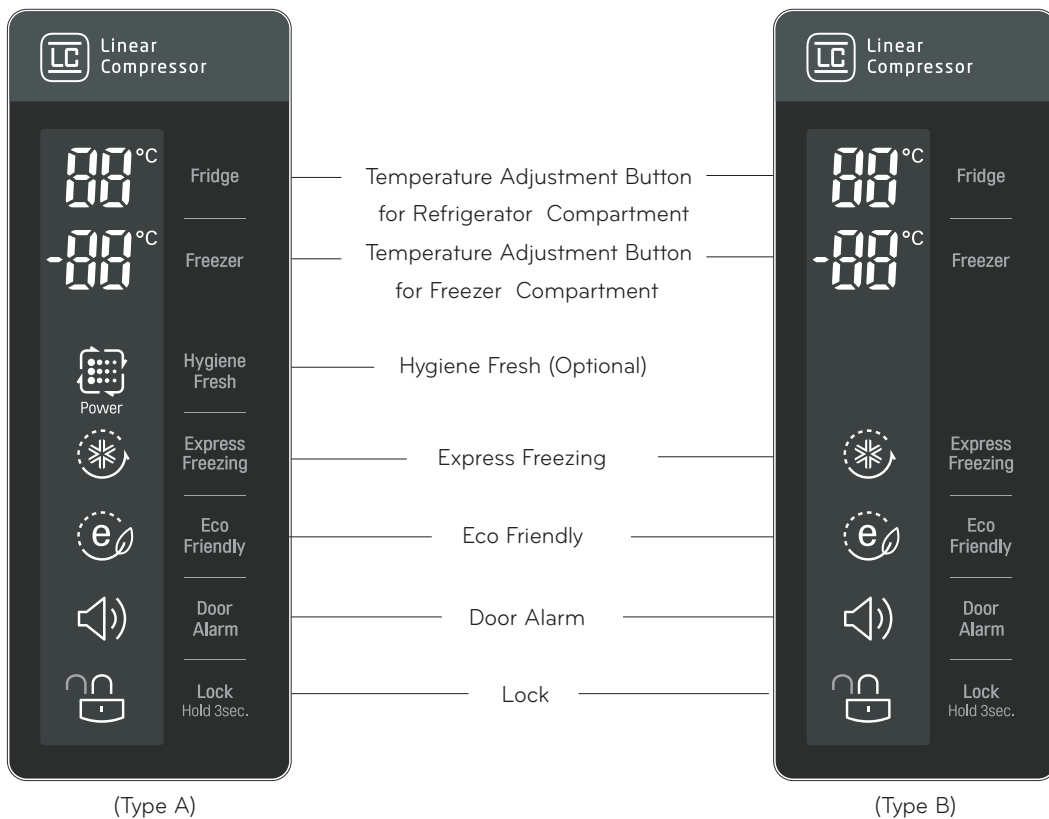

< Interior Type >

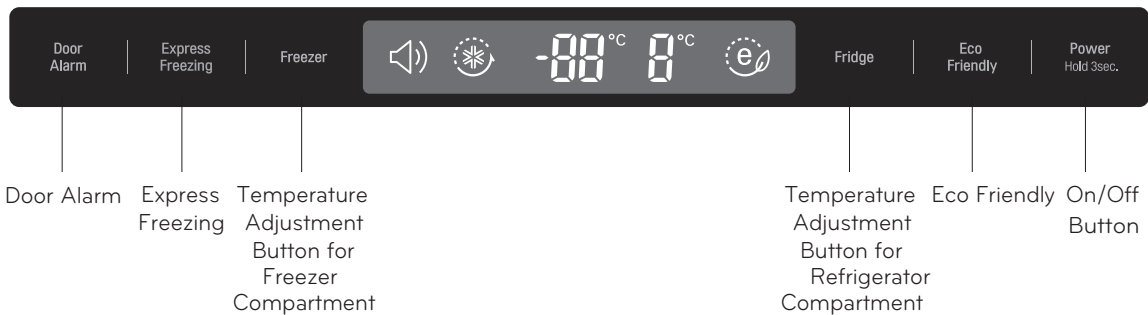

**Note**

See detailed button description on page 13~14

## How to adjust the temperature in the refrigerator compartment

- The initial target temperature of the refrigerator and freezer Compartment is 3°C and -20°C respectively.  
You can now adjust the target temperature of the compartments as you wish.

< Exterior Type >



< Interior Type >



### Refrigerator

When the button is pressed, the temperature of the refrigerator is 3°C ▶ 2°C ▶ 1°C ▶ 7°C ▶ 6°C ▶ 5°C ▶ 4°C ▶ 3°C sequentially.

### Freezer

When the button is pressed, the temperature of the freezer is -20°C ▶ -21°C ▶ -22°C ▶ -23°C ▶ -15°C ▶ -16°C ▶ -17°C ▶ -18°C ▶ -19°C ▶ -20°C sequentially.

### Note

The actual inner temperature varies depending on the food status, as the indicated setting temperature is a target temperature, not actual temperature within refrigerator. Refrigeration temperature stability may fluctuate initially. Please adjust temperature as above after using refrigerator for minimum 2~3 days.

## Hygiene Fresh (Optional)



- The Hygiene Fresh function has three modes, Auto (default mode when icon is lit up) Power mode (when icon and Power are lit up) and Off (icon is not lit up). Power mode can be engage by pressing the Hygiene Fresh touch control respectively

Auto>Power>Off>Auto...

Power mode will resume back to Auto mode after 4 hours.

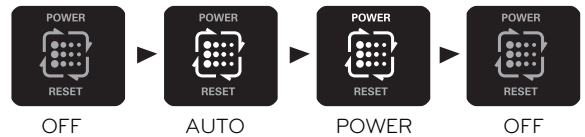

## Express Freezing.

- Select this function for prompt freezing.
- This function is used when you want to freeze the foods quickly. Press the Express Freezing button once, and then the quick freeze operation starts and the Express Freezing lamp will be on.
- The Express Freezing operation takes about 24 hrs. When its operation ends, it automatically returns to the previous temperature setting. If you want to stop the quick freeze operation manually, press the Express Freezing button once more, the lamp goes out, and the Express Freezing operation stops and the refrigerator returns to the previous temperature setting.

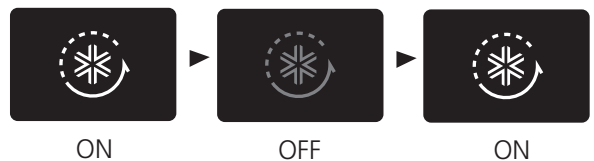

- The Express Freezing indicator remains on after the Express Freezing function is selected.

## Eco Friendly

- This function makes the refrigerator work in a power saving mode which is useful for when you are away on holiday, by reducing energy consumption.

Pressing 'ECO FRIENDLY' starts the operation and turns the lamp on and pressing it again stops the operation.

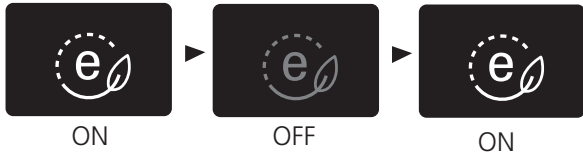

### Note

When the Eco Friendly mode is "ON", the Refrigerator, Freezer temperature buttons and Express Freezing function will not operate. To cancel the Eco Friendly mode, press the Eco Friendly button off so that the other buttons work and the refrigerator returns to the previous temperature setting.

## Self Test

- This function automatically detects certain malfunctions when the refrigerator is in use.
- When a malfunction occurs, the temperature display locks out and cannot be changed. Do not turn off the power. Call your nearest service provider so that they can diagnose the display indicators. If the power is turned off the error message will be reset and may be difficult to properly diagnose.

## Door Alarm

- When the doors of the refrigerator are opened for longer than 1 minute, the alarm sounds repeatedly every 30 seconds until the door is closed. Please contact with the local service center if the alarm continues to sound even after closing the door.
- The door alarm can be muted by pressing the Alarm button.



## Lock

### < Exterior Type >

- Pressing this button stops the operation of other buttons.
- "Locking" or "Un-Locking" is repeated whenever pressing the LOCK button. (For "Locking" press the "LOCK" button for 3 secs. For "Un-Locking" press the "LOCK" button for 3 secs.)
- When 'LOCK' is activated, all other buttons will not respond. The lock function does not stop the water dispensing operation on models fitted with a water dispenser.

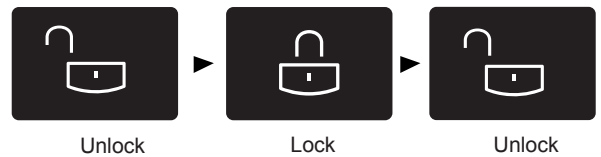

## On/Off

- Pressing this button turns the refrigerator power ON or OFF. In the OFF mode, the unit will stop cooling and the interior lights will not turn on when the door is opened.
- ON or OFF is repeated whenever pressing the ON/OFF button. (For "OFF" press the "ON/OFF" button for 3~7 secs. For "ON" press the "ON/OFF" button for 1 sec.)

### Note

This button does not isolate the mains power from the refrigerator.

## Ice Making

- Take out the twist ice maker, fill it up and put it back to it's original location.

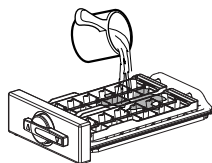
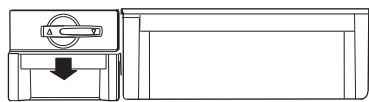

- Ice is dropped into the ice storage bin by rotating the Ice separation handle on the ice making compartment.



- You can make ice or use this space as a storage space for Frozen food. Removing (1) (Twist ice maker) as shown in the picture.

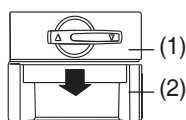

### Note

- Rotating the ice separation handle before ice is fully frozen may cause the remaining water to drop into the ice storage bin and lump the ice together.
- Never pour water into the ice storage bin for the intension of freezing it as it can break the ice storage bin.
- When the ice storage bin is full, it is designed for the ice to fall to the bottom in case is overfilled . Be careful not to overfill the storage bin.
- Gently remove the ice storage bin when accessing ice so that the slide stopper is not broken.

## Defrosting

- Defrosting takes place automatically.
- The defrosting water flows down to the evaporating tray and is evaporated automatically.

## How to separate the vegetable drawer

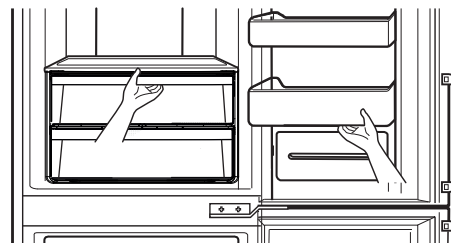

- Remove the lower basket from the door by lifting it up.  
Pull the drawer until it stops and while slightly lifting it up, pull it further to remove it completely.



## Water Dispenser (Optional)

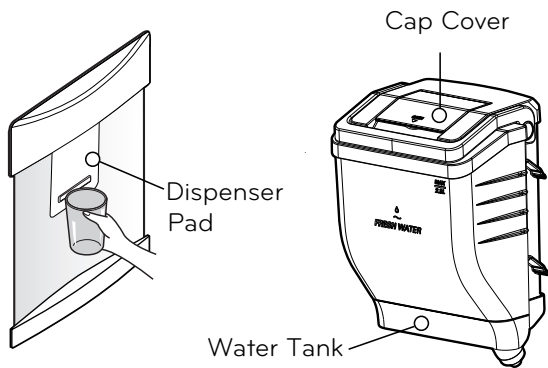

### Filling of WATER TANK

#### How to Remove the Water Tank

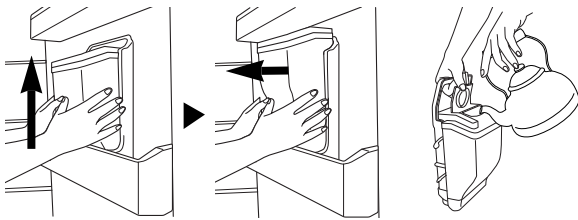

- Refitting is done in reverse to removal
- Be careful not to press on the dispensing valve.
- When refitting the tank to the door, ensure that it is properly secured in its place.

1. Pull out the water tank.  
Then open the cap cover.
2. Up to 2.3 liters of water can be added.
3. Only fill with drinkable water. Never fill with any other liquid other than water. Never pour hot water into the tank.

### Drinking

1. Press the dispenser pad with a cup or glass.
2. Water will be dispensed for as long as the pad is pressed.
3. To minimise any spillage, slowly remove the cup or glass from the dispenser pad.
4. In the event of accidental spillages, wipe up any water from the dispenser area with a soft cloth.

### ⚠ CAUTION

Filling the water tank with beverages other than drinking water may cause the dispenser to malfunction.

### ⚠ WARNING

Fill with drinkable water only.  
Do not fill the water tank with any other beverages. It must be filled with drinkable water only.  
Never fill with hot or warm water.

### Note

When dispensing problems occur, re-install the waterbottle securely.  
The dispenser pad should be firmly pressed when dispensing water.

## Sliding Shelf (Optional)

You can slide the sliding shelf in if you need to accommodate taller containers or products on the shelf underneath.

### Note

Remove all items from the rear half shelf and the front sliding shelf.

1. Slightly lift up the front of the sliding shelf and slide it inward.
2. The rear half shelf will raise to allow the front to slide in under it, or it can be lifted manually toward the rear wall to allow easier sliding of the front sliding shelf.
3. You can simply pull out the sliding shelf in reverse procedure to return it to the extended position.

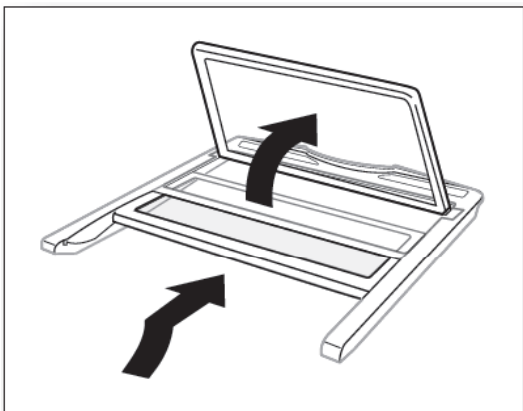

### ⚠ CAUTION

Caution should be taken when adjusting the shelf as it can fall out if not handled correctly.

### ⚠ CAUTION

Do not lift up the rear half shelf and keep it in the lifted position. Tall items are not to be stored at the rear of the shelf.

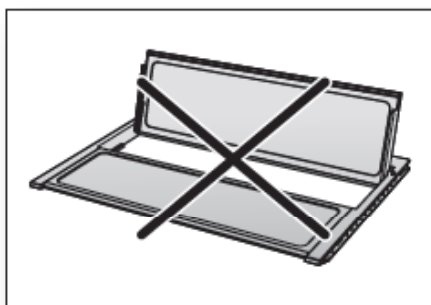

## How to remove the rear half shelf.

Slide the front sliding shelf in under the rear half shelf. Then lift the rear half shelf up to remove it.

### Note

Make sure the rear half shelf and the front sliding shelf are securely restored to the shelf position before placing items upon it

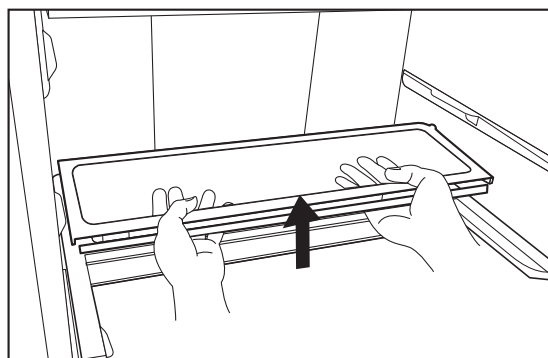
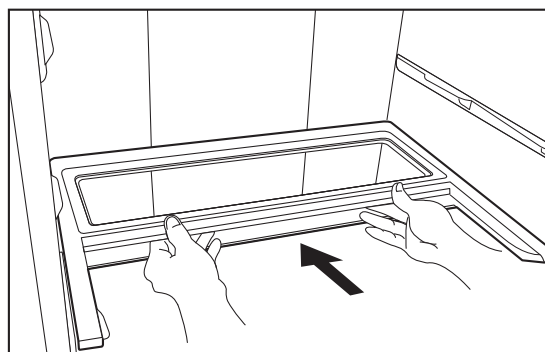

## Pull Out Tray (Optional)

The pull out tray offers easy access to items stored at the rear of the tray by sliding it out closer to you.

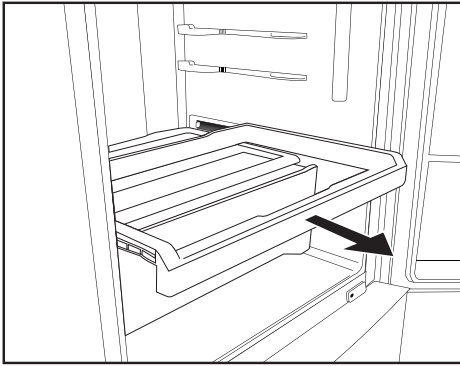

### ⚠ CAUTION

Please do not hold the bottom of the tray when slide the tray in, as it could catch your hand.

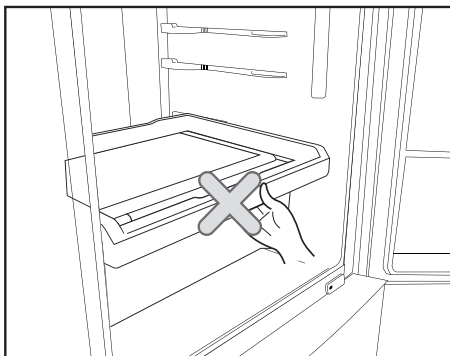
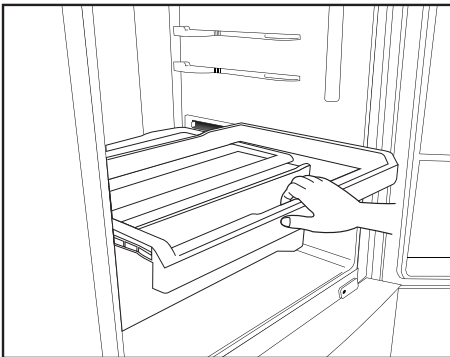

## How to remove the Pull Out Tray

Fully extend the Pull-Out-Tray and lift the front then pull it out slowly.

### Note

Before removing the pull out Tray, remove the second lowest door basket from the refrigerator door.

### Note

Apply caution when pulling out the tray so that items do not fall off. Remove all food items from on the tray first before removing it.

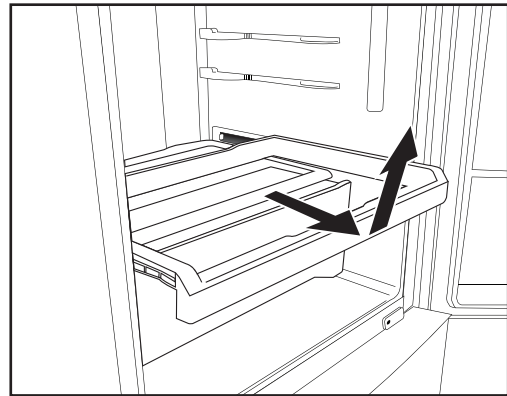

## Lamp Replacement

### Note

This product uses LED Lamps which can not be replaced by the user. Please contact an authorized service center for LED lamp service or replacement.

## Storing Food

### ⚠ CAUTION

- Do not store food which spoils easily at low temperature, such as banana, and melon.
- Allow hot food to cool prior to storing. Placing hot food in the refrigerator could spoil other food, and lead to higher electricity bills.
- When storing the food, use a container with a lid. This prevents moisture from evaporating, and helps food to keep its taste and nutrients.
- Do not block air vents with food. Smooth circulation of cold air keeps refrigerator temperature even.
- Do not open the door frequently. Opening the door lets warm air enter the refrigerator, and cause temperature to rise.
- Never keep too many foods in the door baskets, as this may stop the door from fully closing.
- Do not store bottles in the freezer compartment- they may break when frozen and cause injury.
- Do not refreeze food that has been thawed. This causes loss of taste and nutrition.
- Do not store pharmaceutical products, scientific materials or other temperature sensitive products in the refrigerator.  
Products that require strict temperature controls must not be stored in the refrigerator.
- If you want to quick freeze new food, place it in the middle drawer of freezer compartment, and then press the Express Freezing button.
- To ensure good air circulation in the appliance, push in the freezer drawers all the way.

## Suggestion for energy saving

- Please do not keep the door open for a long period of time.
- Do not over load the shelves and drawers with food as this will compromise the air flow and cause the refrigerator to run for longer periods.
- Do not set the temperature of refrigerator lower than needed. Do not put the food near the temperature sensor. Keep a distance of at least 5cm from the sensors.
- Allow hot food to cool prior to storing. Placing hot food in the refrigerator could spoil other food, and lead to higher electricity bills.
- Do not block air vents with food. Smooth circulation of cold air keeps refrigerator temperatures even.
- Do not open the door frequently. Opening the door lets warm air enter the refrigerator, and cause internal temperatures to rise.
- Arrange food items so that frequently used items are placed toward the front of the shelves or drawers.

## General Information

### Vacation time

---

- During average length vacations, you will probably find it best to leave the refrigerator in operation. Place freezable items in freezer for longer life. When you plan not to use the appliance, remove all food, disconnect the power cord, clean the interior thoroughly, and leave each door OPEN to prevent odor formation.

### Power Failure

---

- A 1 to 2 hour power failure will not significantly disrupt the internal temperature. Try to avoid opening and closing the door too frequently so that the temperatures remain as stable as possible until the power is restored.

### If You Move

---

- Take out all food from the refrigerator and firmly fix loose items with tape.
- Turn the leveling screws until they stop before moving the refrigerator. Otherwise they may scratch the floor and cause the refrigerator not to move.

### Anti Condensation Pipe

---

- The Anti-Condensation pipe is installed around the front side of refrigerator and freezer, as well as on the partition between refrigerator compartment and freezer compartment to prevent dew and condensation.

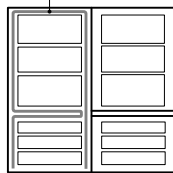

- Especially after installation or when ambient temperatures are high, the refrigerator may feel hot on the front and side surfaces, which is quite normal.

## Cleaning

### Before Cleaning

Be sure to unplug the power before cleaning or vacuuming any exterior surface or covers.

### Exterior

Clean the outside of the refrigerator with a soft cloth soaked with warm water or mild dishwashing detergent. If you use a detergent, be sure to wipe it with a clean wet cloth.

### Interior

Same as above.

### After Cleaning

Check that the power cord is not damaged, power plug has not overheated, and that the power plug is properly inserted into the outlet.

### ⚠ WARNING

Be sure to dry the appliance with a cloth after wiping it with water.  
Do not use abrasive, petroleum, benzene, thinner, hydrochloride acid, boiling water, rough brushes or scourers, etc, as they may damage parts of the refrigerator.

### Water Dispenser Drip Tray

Wipe moisture from around the door part and the drip tray using a clean cloth.

### Water Dispenser

Wipe moisture from the dispenser area and on the dispenser pad using a cloth.

### Separating the Water Tank lid from the water tank.

1. Remove the Water Tank from the door (refer to page 16). Lift up the release lever and release the 2 side clips on the Tank lid.
2. The water tank can be washed when removed from the refrigerator by using neutral cleansing agents. Rinse thoroughly before refitting and refilling.

### Cleaning the Water Tank and filling lid

The water tank lid and filling cap should be cleaned periodically after being removed from the water tank. A small brush such as a toothbrush can be used to clean the grooved part of the filling cap.

### ⚠ CAUTION

Ensure that the Water Tank lid is securely fitted to the Water Tank before filling it through the fill hole.

## Smart Diagnosis™

(Optional)

Should you experience any problems with your refrigerator, it has the capability of transmitting data via your telephone to the LG service center. This gives you the capability of speaking directly to our trained specialists. The specialist records the data transmitted from your machine and uses it to analyze the issue, providing a fast and effective diagnosis.

If you experience problems with your refrigerator, call to the LG service center.

Only use the Smart Diagnosis feature when instructed to do so by the LG call center agent. The transmission sounds that you will hear are normal and sound similar to a fax machine.

Smart Diagnosis cannot be activated unless your refrigerator is connected to power.

If your refrigerator is unable to turn on, then troubleshooting must be done without using Smart Diagnosis.

First, call to the LG service center. Only use the Smart Diagnosis feature when instructed to do so by the LG call center agent.

1. Open the refrigerator door.



3 sec.

2. Press and Hold the 'Freezer' button for 3 seconds.



### Note

If the door has been opened for over one minute, you must close the door and start again from step 1.

3. Following the instructions of the operator, hold the phone's microphone close to the icon «SmartDiagnosis».

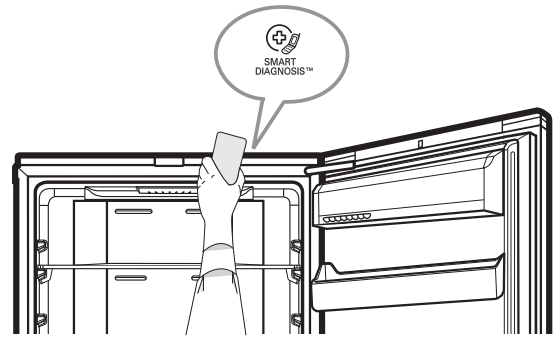

4. Hold the phone in the position until the end of the sound data transfer.

5. Keep the phone in place until the tone transmission has finished. This takes about 3 to 6 seconds

Resume your conversation with the consultant, who will then be able to assist you in using the information transmitted for analysis.

### Note

- For best results, do not move the phone while the tones are being transmitted.
- If the call center agent is not able to get an accurate recording of the data, you may be asked to try again.
- Call quality differences by region may affect the function.
- Use the home telephone land line for better communication strength and signal clarity.
- Poor signal quality may result in poor data transmission from your phone to the machine, which could cause Smart Diagnosis to not work properly.

## Trouble Shooting

Before calling for service, check this list. It may save you both time and expense. This list includes common occurrences that are not the result of defective workmanship or materials in this appliance.

Problem	Possible Causes
<b>Refrigerator does not operate</b>	<ul style="list-style-type: none"> <li>• Power plug may be unplugged from the power outlet. Plug it in securely.</li> <li>• House fuse has blown or circuit breaker has tripped. Check and/or replace fuse and reset circuit breaker.</li> <li>• Power cut. Check house lights and other appliances.</li> </ul>
<b>Refrigerator or Freezer Compartment Temperature too warm</b>	<ul style="list-style-type: none"> <li>• Temperature control not set on proper position. Refer to Temperature Control section.</li> <li>• Appliance is placed close to a heat source.</li> <li>• Warm weather-frequent door openings.</li> <li>• Door left open for a long time.</li> <li>• Package holding door open or blocking air duct in freezer compartment.</li> </ul>
<b>Vibration or Rattling or Abnormal Noise</b>	<ul style="list-style-type: none"> <li>• The floor on which the refrigerator is installed may be uneven or the refrigerator may be unstable. Make it even by rotating the leveling feet.</li> <li>• Unnecessary objects placed in the back side of the refrigerator.</li> </ul>
<b>Frost or Ice Crystals on frozen Food</b>	<ul style="list-style-type: none"> <li>• Door may have been left ajar or package holding door open.</li> <li>• Too frequent or too long door openings.</li> <li>• Frost within food packaging can be normal.</li> </ul>
<b>Moisture forms on Cabinet Surface</b>	<ul style="list-style-type: none"> <li>• This phenomenon is likely to occur in a wet or humid environment. Wipe it with a dry towel.</li> </ul>
<b>Moisture collects inside</b>	<ul style="list-style-type: none"> <li>• Too frequent or too long door openings.</li> <li>• In humid weather, air carries moisture into refrigerator when doors are opened.</li> </ul>
<b>Refrigerator has odor</b>	<ul style="list-style-type: none"> <li>• Foods with strong odors should be tightly covered or wrapped.</li> <li>• Check for spoiled food.</li> <li>• Interior needs cleaning. Refer to CLEANING section.</li> </ul>



### **Door not closing properly**

- Food package is keeping door open.  
Move packages that keep door from closing.
- Refrigerator is not level.  
Adjust the leveling feet.
- The floor on which the refrigerator is installed may be uneven or the refrigerator may be unstable.  
Slightly raise the front side of the refrigerator by turning the leveling feet clockwise.

### **Interior light does not work**

- No power at outlet.
- If the LED lamp does not function, you must contact an authorised service provider or the manufacturer.

### **No water dispensing**

- Water level is too low in Water Tank.  
Fill the Water Tank with water. (Approx. 2.3 Lt capacity)

## It is normal...

The following occurrences are normal.

	Occurrence	Solution
<b>Noise</b>	When you hear "Tak" or "Took" sound	This is the sound of various parts expanding/contracting or various control devices operating depending on the temperature change within the refrigerator.
	When you hear "Deureureuk~", "Dulkuk" or "Woong" sound	This is the compressor or fan operating when the operation of the refrigerator is starting or ending. This is the same phenomenon of the sound generated when starting or turning off the engine of a car.
	When you hear "Kureureuk" sound of water flowing	This is the sound of refrigerant changing the condition in the freezer/refrigerator. When the liquid changes to gas, you will hear the sound of water flowing and when gas changes to liquid, you will hear the "Kureureuk" sound.
	When you hear the sound of wind such as "Shoo~" or "Shik" right after you close the door	This is the sound generated when the internal pressure is temporarily lowered when the warm air entered through the refrigerator or freezer is rapidly cooled.
	When you hear a vibrating sound	If the refrigerator is installed on wooden floor or wooden wall, or if the refrigerator is not leveled properly, the sound can be loud from the vibration.
	When you hear a loud sound after installing the product for the first time	When you operate the refrigerator for the first time, the refrigerator will operate at high speed to cool fast and the sound can seem louder. When the internal temperature falls below a certain level, the noise will subside.
<b>Door open</b>	When the door is slightly opened after closing the door	Depending on the force or speed of closing the refrigerator or freezer door, the door can open slightly and then close again. Be careful not to close the door too hard.
<b>Icing/ Dew drops</b>	When there is icing or dew drops formed on the inner or outer side of the refrigerator	When warm external air flows into the cool inner surface of the refrigerator, icing/dew drops can be formed. Especially, this will happen more easily when you open and close the refrigerator door more frequently. Also if the humidity of the installed location is high or during the rainy season or on a rainy day, condensation can form on the outer side of the refrigerator. This is a natural phenomenon that occurs during the humid weather. Wipe the condensation with a dry cloth.
<b>Temperature</b>	When the front side of the refrigerator is warm	Heat pipes are installed around the front part of the refrigerator and on the divider of the freezer and refrigerator to prevent condensation from forming. The refrigerator may feel warmer after the installation or during summer, this is not a malfunction and is a normal occurrence.



