



OWNER'S MANUAL

SXS

REFRIGERATOR

Please read this guide thoroughly before operating and keep it handy for reference at all times.

Table of contents

Introduction	Entry	4
	Important safety instruction	4
	Important safety instruction	5
	Identification of parts	13
Installation	Where to install	14
	Method to remove protection film (Feature not available in all countries)	14
	No Plumbing Ice & Water (Feature not available in all countries)	15
	Door removal	16
	Door replacement	17
	When the freezer door is lower than the refrigerator door	18
	When the refrigerator door is lower than the freezer door	18
Operation	Starting	19
	Adjusting the temperatures and functions	19
	Refreshment center (Feature not available in all countries)	24
	Shelf	25
	Egg box (Feature not available in all countries)	25
	Deodorizer (Feature not available in all countries)	26
	Freezer compartment	26
Suggestion on food storage	Location of foods	27
	Storing foods	28
Care and maintenance	How to dismantle parts	29
	General information	31
	Cleaning	31
	Trouble shooting	32
	It is normal...	37
	Smart Diagnosis (Applicable to some models only)	38

Entry

The model and serial numbers are found either on the inner case or the back, or the lower RHS outer cabinet, written on a label. These numbers are unique to this unit and not available to others. You should record requested information here and retain this guide as a permanent record of your purchase. Staple your receipt here.

Date of purchase : _____
 Dealer purchased from : _____
 Dealer address : _____
 Dealer phone no. : _____
 Model no. : _____
 Serial no. : _____

Important safety instruction

Before it is used, this refrigerator must be properly installed and located in accordance with the installation instructions in this document.

When moving your appliance away from the wall, be careful not to roll over the power cord or to damage it in any way.

After your refrigerator is in operation, do not touch the cold surfaces in the freezer compartment, particularly when your hands are damp or wet. Skin could adhere to these extremely cold surfaces.

Unplug the power cord from the power outlet for cleaning or other requirements. Never touch it with wet hands because you can get an electric shock or be hurt.

Never place glass products in the freezer because they may be broken due to expansion when their contents are frozen.

Never allow your hands within the ice storage bin of the automatic ice maker. You could be hurt by the operation of the automatic ice maker.

The appliance is not intended for use by young children or infirm persons without supervision.

If possible, connect the refrigerator to its own individual electrical outlet to prevent it and other appliances or household lights from causing an overload that could cause a power outage.

The refrigerator-freezer should be so positioned that the supply plug is accessible for quick disconnection should an accident happen .

If the supply cord is damaged, it must be replaced by the manufacturer or its service agent or a similarly qualified person in order to avoid a hazard.



Don't use an extension cord

**Accessibility of Supply Plug
Supply Cord Replacement**

Important safety instruction

BASIC SAFETY PRECAUTIONS

This guide contains many important safety messages. Always read and obey all safety messages.

 This is the safety alert symbol. It alerts you to safety messages that inform you of hazards that can cause death or serious personal injury or cause damage to the product. All safety messages will be preceded by the safety alert symbol and the hazard signal word DANGER, WARNING, or CAUTION. These words mean:

 **DANGER** Death, or serious injury can occur if you don't follow instructions.

 **WARNING** Death, or serious injury can occur if you don't follow instructions.

 **CAUTION** Indicates an imminently hazardous situation which, if not avoided, may result in minor or moderate injury, or product damage only.

All safety messages will identify the hazard, tell you how to reduce the chance of injury, and tell you what can happen if the instructions are not followed.

WARNING

To reduce the risk of fire, electric shock, or injury to persons when using your product, basic safety precautions should be followed, including the following. Read all instructions before using this appliance.

1. When connecting the power

A dedicated outlet should be used.

- Using several devices at one outlet may cause fire.
- If unit is connected to an earth leakage breaker it may trip resulting in spoiled food. This could occur due to power supply circumstances, and may not necessarily mean a refrigerator malfunction.

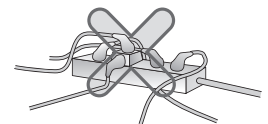

Do not allow the power plug to face upward or to be crushed at the back of the refrigerator.

If the cord is crushed behind the refrigerator it may damage the cable resulting in fire. An upward facing plug may pull loose under the weight of the cord resulting in electrical failure causing fire or the fridge turning off and spoiling food.

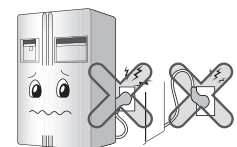

Do not allow the power cord to be bent or crushed by heavy objects.

It may damage the power cord and cause fire or electric shock.



Do not extend or modify the length of the power plug.

It can cause electric shock or fire from incorrect installation or unsafe connection.

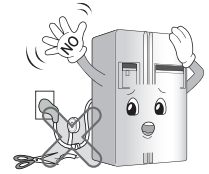

Unplug the power plug when cleaning, handling or replacing the interior lamp of the refrigerator.

- Not doing so may cause electric shock or injury.
- When replacing the interior lamp of the refrigerator, make sure that the insulating rubber ring within the socket is not taken off.

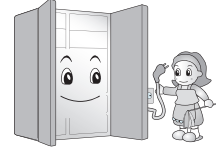

Do not pull out the cord or touch the power plug with wet hands.

- It may cause electric shock or injury.

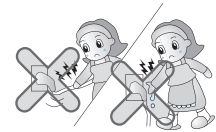

Remove water or dust from the power plug and insert it with the ends of the pins securely connected.

Dust, water or an unstable connection may cause fire or electric shock.

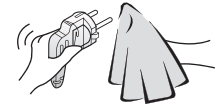

Make sure of grounding.

Consult a qualified electrician or service person if the grounding instructions are not completely understood, or if you have doubts on whether the appliance is properly grounded.

The incorrect grounding may cause breakdown and electric shock.

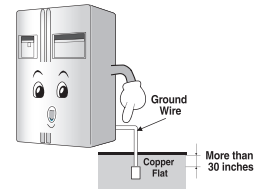

When the power cord or the power plug is damaged or the power outlet is loose or damaged, do not plug the power cord into the power outlet.

Doing so may cause electric shock or be the cause of a fire.

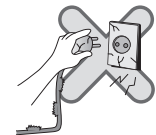

Unplug the power cord from the power outlet for cleaning or other requirements.

Not doing so may cause electric shock or injury.

2. When using the refrigerator

Do not place dangerous items, or heavy objects (including containers with liquid) on the refrigerator.

They may fall or spill and cause injury, fire or electric shock when opening or closing the door.



Do not install the Refrigerator in a wet place or any outdoor sheltered environment where it can be exposed to rain or moisture.

Doing this can cause corrosion and rust as well as electrical hazards.

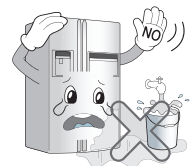

Do not lean on or hang from the doors or shelves of the refrigerator.

This will damage the doors and shelves of the refrigerator or cause it to topple over resulting in serious injury and damage. Always supervise children when they are near the refrigerator.

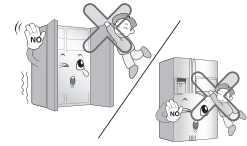

This refrigerator is intended for normal domestic indoor use. It must not be used outdoors, or stored in an out door location that is exposed to any weathering conditions.

Do not use or store inflammable materials such as chemicals, solvents, benzene, alcohol, medicine, LP gas, spray or cosmetics near or in the refrigerator.

It may cause explosion or fire.

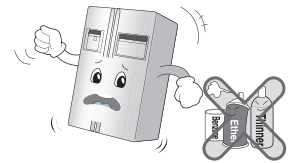

Do not use any heating or drying appliances inside the refrigerator, or use lit candles to remove odours.

It may cause explosion or fire.



Do not insert hands into the ice bucket or the ice dispenser. (only for the model with the dispenser).

It may cause injury while operating the icemaker.



Do not store medical supplies, temperature critical medicines, or scientific materials in the refrigerator.

If materials with strict temperature restrictions are stored they may deteriorate or react undesirably resulting in possible harm or risk.

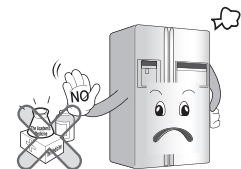

Do not use the combustible spray near the refrigerator.

Do not store explosive substances such as aerosol cans with a flammable propellant in this appliance.

It may cause fire.

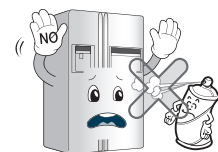

Install in places away from the heat sources such as fireplaces, heaters and ovens. Pay particular attention to avoid locating near gas related products.

Not doing so may become the cause of an explosion or fire.

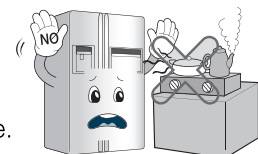

Supply the refrigerator with drinkable water only (only for the model with the dispenser).

A health risk could occur if connected to non drinkable water.

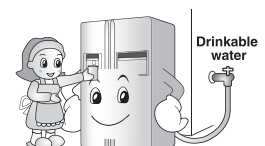

Do not place flower vases, cups, cosmetics, medicine or any container with water on the refrigerator.

They may fall, leak or spill resulting in possible electric shock or fire.

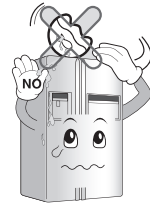

If the refrigerator has been exposed to any water submersion, it must not be used until it has been checked and certified by a licenced Electrician.

It may cause electric shock or fire.

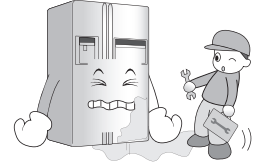

If a gas leak is detected, do not touch the refrigerator or the outlet and ventilate the room immediately.

- Any spark may result in an explosion or fire.
- Because this refrigerator uses natural gas (isobutene, R600a) as the environment-friendly refrigerant, even a small amount (80~90g) is combustible. If a gas leak occurs due to severe damage during delivery, installation or a sealed system malfunction, a spark may cause a fire. (Only for the model with the R600a.)

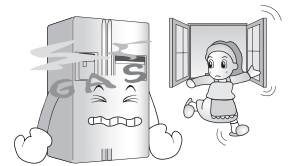

Do not move refrigerator while the compressor is operating.

Compressor may occur a temporary rattling noise. (This is normal and will not impact on the performance or the life of the compressor. The rattling will stop after the refrigerator comes to a rest.)

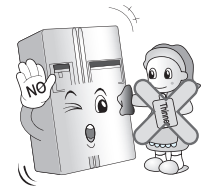

Do not spray water on the outside or the inside of the refrigerator, and do not clean it with harsh chemicals or solvents such as thinners or benzene.

Doing so can cause a fire, electric shock, malfunction. It can also damage the refrigerators finish.

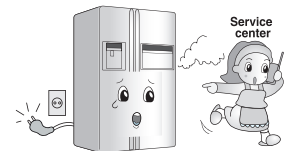

When any burning smell or smoke is detected from the refrigerator, disconnect the power plug immediately and contact the manufacturer or an authorised service provider.

Although some smells and odors can be normal, no risks should be taken.

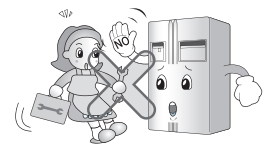

Do not allow any person except a qualified engineer to disassemble, repair or alter the refrigerator.

It may cause injury, electric shock ,malfunction or fire.

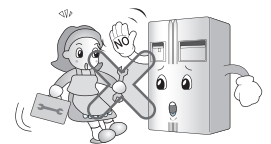

This refrigerator must not be used for any Commercial retail purpose or mobile applications. It has been designed for normal Domestic,indoor use only.

Applications outside of its intended purpose may cause malfunctions,breakages, electrical shock, fire, and loss of its stored contents.

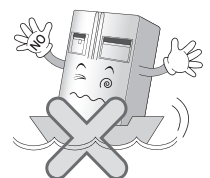

When disposing the refrigerator, remove the doors but leave the shelves in place so that children may not easily climb inside.

This can prevent injury or death.



Install the refrigerator on a solid and level floor.

Installing it in an unstable place may cause death by the refrigerator falling over when opening or closing the door.

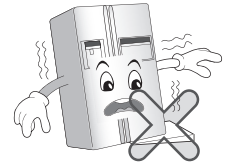

Do not insert hands or any objects or instruments into the bottom of the refrigerator, or the heatproof grill (exhaust vents) at the rear side of the cabinet.

It may cause electric shock or injury.

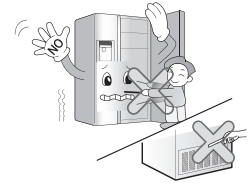

When disposing the refrigerator, contact your local City Council.

Your local Council can offer disposal options and advise the best method of disposal.



CAUTION

Violating these instructions may cause injury or damage to your home or its contents. Always be careful, please.

Do not touch food or containers in the freezer with wet hands.

This may cause frostbite.

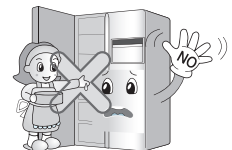

Do not dispense ice into thin crystal or ceramic ware.

It could break the glass, cup or ceramic ware and cause injury.

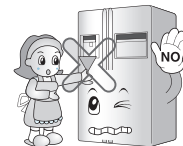

If the electricity is removed (e.g. Power failure) for an extended period of time, remove ice from ice bucket. (only for the model with the dispenser).

A Long term power failure may cause the ice in the ice bucket to melt and drip water onto the floor causing damage.



If the mains plug is removed from the wall outlet for any reason, wait for 5 minutes or longer before reconnecting the plug.

Not doing so may cause the operation of the refrigerator to fail.

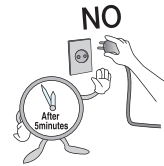

Do not put filled bottles in the freezer.

This will freeze the contents and break the bottle possibly resulting in injury.



Pull out the power plug by grasping the plug, not the cord.

Not doing so can cause electric shock, short circuit or fire.



Do not install the refrigerator in a wet place or outdoors in any sheltered area where the unit can be exposed to any weathering conditions.

Weathering conditions, water or moisture will cause corrosion, rust and electrical hazards.

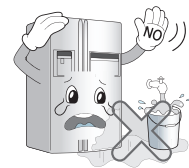

Do not insert hands into the bottom of the refrigerator.

The iron plate of the bottom may cause injury.



Carry the fridge-freezer with the handles at the bottom of the front and the top of the rear.

Otherwise, your hands may slip possibly resulting in injury or product damage. Because the product is heavy, carrying it will require more than one person in order to avoid any possible injury.

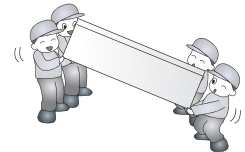

Care should be taken when opening or closing the doors to prevent injury to anyone who may be too close to the doors.

Children may be hurt by the handle or lower corners of the door when it is opened if they are too close.

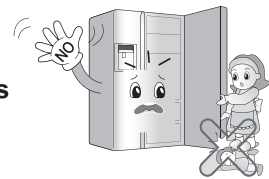

Do not put any living animals or non edible plants in the refrigerator.

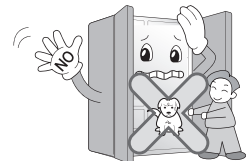

Ensure that all foods and containers are stored or stacked in a stable manner.

The container may fall during opening and closing of the door of the refrigerator and cause injury or breakages.

WARNING

1. When connecting the power

Prevent the power cord from being crushed or imprinted when the refrigerator is pushed in after the power plug is connected during the installation.

When moving your appliance away from the wall, be careful not to roll over or damage the power cord.

It can be the cause of fire or electric shock.

Only connect the refrigerator to an approved outlet with the correct specified supply voltage.

It can be the cause of fire.

If the supply cord is damaged, it must be replaced by the manufacturer or its service agent or a similarly qualified person in order to avoid any hazard.

2. When using the refrigerator,

Do not damage the sealed system or any piping in or within the refrigerator.

Never Allow children to enter or play inside the compartments of the product.

It may endanger the life of a child if the child enters the refrigerator.

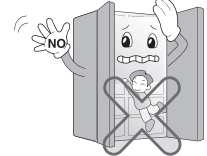

Take care when opening and closing the refrigerator doors. Vigorous opening or closing may cause the contents to topple out resulting in injury or damage.

It is normal for the Freezer door to open if the refrigerator door is closed with excessive force.

Do not use the home bar door as a resting table, or put heavy things on the Home Bar door.

(Only for the models with the Home Bar)

Heavy Items will cause damage to the door and possible injury.

It is recommended that the refrigerator be disconnected during severe electrical storms or if not in use for long periods.

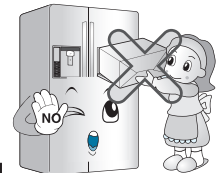

Power surges from electrical storms can seriously damage the refrigerator's electrical components. If the refrigerator is not used for long periods, storage measures should be taken to avoid odours and vermin contamination.

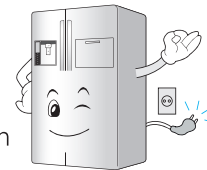

CAUTION

Do not insert the hands into the ice bucket or the ice dispenser.

Operating the ice maker incorrectly may cause injury.

Do not remove the external cover of the water and ice dispenser.

(Only for the models with automatic ice maker)

The mechanical and electrical parts of the icemaker may cause injury or an electrical shock hazard.



Arrange food and items appropriately inside the refrigerator.

The food may fall during opening and closing of the doors causing both damage to the unit or injury to persons.

 **CAUTION**





This appliance is not intended for use by persons (including children) with reduced physical, sensory or mental capabilities, or lack of experience and knowledge, unless they have been given supervision or instruction concerning use of the appliance by a person responsible for their safety.

Children should be supervised to ensure that they do not play with the appliance.

 **WARNING**

If LED lamp is damaged, it should be replaced by the service center instead of on your own.

 **WARNING**

-  Keep ventilation openings, in the appliance enclosure or in the built-in structure, clear of obstruction.
-  Do not use mechanical devices or other means to accelerate the defrosting process, other than those recommended by the manufacturer.
-  Do not damage the refrigerant circuit.
-  Do not use electrical appliances inside the food storage compartments of the appliance, unless they are of the type recommended by the manufacturer.
-  The refrigerant and insulation blowing gas used in the appliance require special disposal procedures. When disposing, please consult with service agent or a similarly qualified person.



This appliance contains a small amount of isobutane refrigerant (R600a), natural gas with high environmental compatibility, but it is also combustible. When transporting and installing the appliance, care should be taken to ensure that no parts of the refrigerating circuit are damaged. Refrigerant leaking out of the pipes could ignite or cause an eye injury. If a leak is detected, avoid any naked flames or potential sources of ignition and air the room in which the appliance is standing for several minutes.

In order to avoid the creation of a flammable gas air mixture if a leak in the refrigerating circuit occurs, the size of the room in which the appliance may be sited depends on the amount of refrigerant used. The room must be 1m² in size for every 8g of R600a refrigerant inside the appliance. The amount of refrigerant in your particular appliance is shown on the identification plate inside the appliance. Never start up an appliance showing any signs of damage. If in doubt, consult your dealer.

Child entrapment warning

! WARNING : Risk of child entrapment.
 Before you throw away your old refrigerator or freezer:
 Take off the doors but leave the shelves in place so that children may not easily climb inside.
 The appliance is not intended for use by young children or infirm persons without supervision.
 Young children should be supervised to ensure that they do not play with the appliance.

Don't store

Don't store or use gasoline , solvents or other flammable vapor and liquids in the vicinity of this or any other appliance.

Grounding (Earthing)

In the event of an electric short circuit, grounding (earthing) reduces the risk of electric shock by providing an escape wire for the electric current.
 In order to prevent possible electric shock, this appliance must be grounded
 improper use of the grounding plug can result in an electric shock. Consult a qualified electrician or service person if the grounding instructions are not completely understood, or if you have doubts on whether the appliance is properly grounded.

Identification of parts

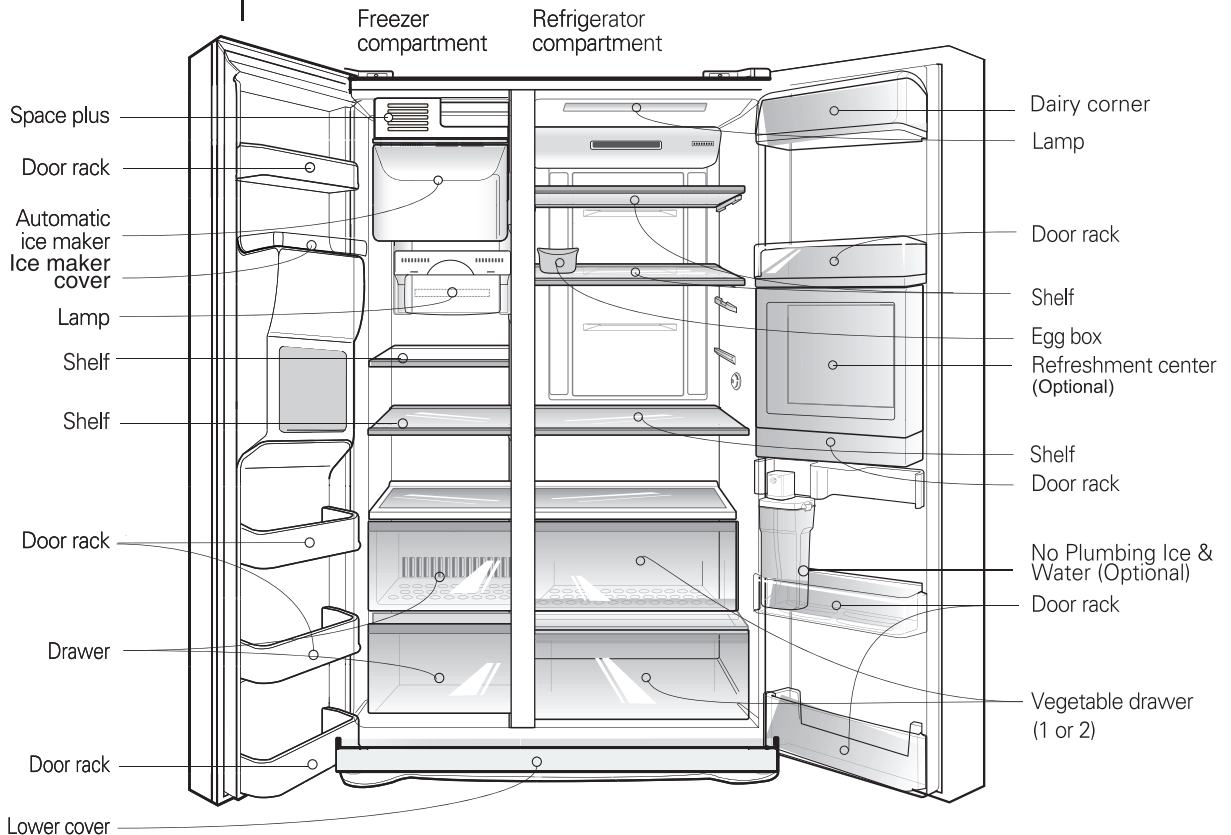

NOTE
 • Parts, features, and options vary by model. Your model may not include every option.

Select a good location

Where to Install

1. Place your appliance where it is easy to use.
2. Avoid placing the unit near heat sources, direct sunlight or moisture.
3. To ensure proper air circulation around the fridge-freezer, please maintain sufficient space on both the sides as well as top and maintain at least 2 inches (5 cm) from the rear wall.
4. To avoid vibrations, the appliance must be leveled.
5. Don't install the appliance in environments below 5°C. It may affect the performance.
6. This appliance is intended to be used in household and similar applications such as staff kitchen areas in shops, offices and other working environments; farm houses and by clients in hotels, motels and other residential type environments; bed and breakfast type environments; catering and similar non-retail applications.

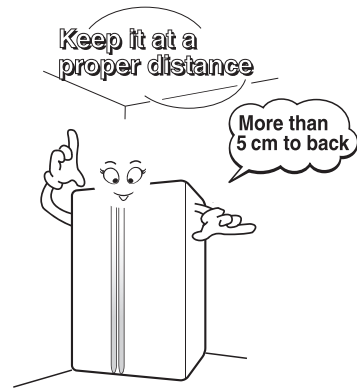

Disposal of the old appliance

This appliance contains fluid (refrigerant, lubricant) and is made of parts and materials which are reusable and/or recyclable.

All the important materials should be sent to a waste material collection center, or call your local City Council for collection or disposal advice.

The other functions

No Plumbing Ice & Water (Applicable to some models only)

You can use the Automatic ice maker and Water Dispenser function without having to connect an external water pipe to the refrigerator. The refrigerator uses an internal water tank located on the refrigerator door to supply water for these functions.

To remove the water tank:

Turn the locking dial to the "OPEN" position as shown in Fig.(1). Then hold and pull the cap of the water tank in the direction of the arrow in Fig.(2) to release the water tank. the water tank can now be lifted carefully out of the door basket for filling or cleaning.

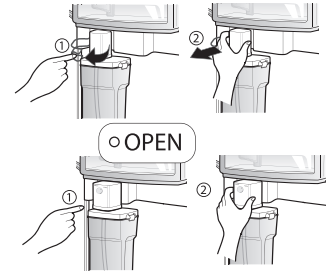

To fill the water tank

Lift up the clamps on both sides to open the water tank cover, and then fill the tank. Pour water up to the marked line (3ℓ). When the tank is full, close the tank cover and lock the clamps on both sides. The water tank can also be filled from the removable fill cap located on the water tank lid.

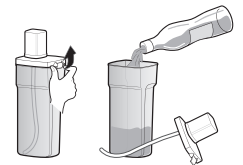

To refit the water tank:

Place the filled water tank back into the door basket and align the pick up nozzle to the water pipe spigot as shown in Fig (3). Firmly push the tank so that the water pick up nozzle locates into the spigot. Fig (4). Then turn the locking dial to the "CLOSED" position. The pump motor will then automatically operate when this is done so that the water line is purged of any air.

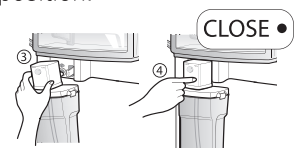

NOTE: If the tank is not inserted correctly, water will leak from the pick up nozzle onto the door basket. Always wait 15 seconds after dispensing water before attempting to remove the water bottle for filling or cleaning.

To cleaning the filter:

Please clean the filter mesh in the water tank after using for 1 week.

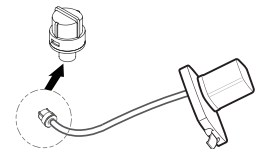

NOTE

- When assembling or disassembling the water tank, be careful not to apply excessive force as it can damage the water tank.
- If there is no water in the water tank, you will not be able to use the Auto Ice Maker function and Water Dispenser function.
- Using other liquid besides water can cause problems to the pump. When the water in the water tank is low, the size of the ice cubes may become smaller.
- It's a good idea to clean out the water initially before filling it with water and placing it into position.
- The method of using the Dispenser and Ice Maker is the same as other common Dispenser models.
- Because the water tank can get heavy, don't let children use or hold the water tank, especially with one hand.
- As the ice maker uses water from the water tank, you may hear the water pump operating 8~10 times per day.

WARNING

Door removal

Electric Shock Hazard

Disconnect electrical supply to refrigerator before install. Failure to do so could result in death or serious injury.

If your access door is too narrow for the refrigerator to pass through, remove the refrigerator door and pass the refrigerator laterally.

The door handles can be removed if only marginal clearances are required to allow the refrigerator to pass through a narrow door.

Remove the lower cover by lifting upward and then pull up the feed water tube while pressing area ① shown in the figure to the right.

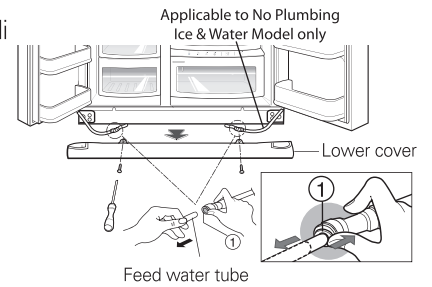

NOTE

If the tube end is deformed or abraded, cut that part away.

1) Removing the hinge cover by loosening the screws. Separate all connection wires except for the earth line after.

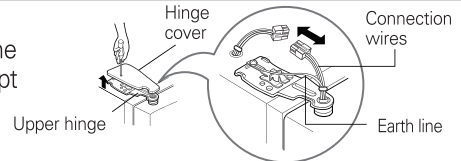

2) Remove the keeper by rotating it counter clockwise (①) and then lifting the upper hinge up (②).

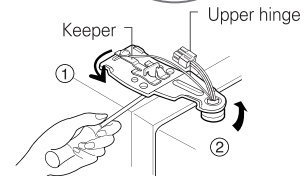

CAUTION

When removing the upper hinge, be careful that the door does not fall forwards.

3) Remove the freezer compartment door by lifting it upward. This time, the door should be lifted enough for the feed water pipe tube to be completely pulled out.



NOTE

Move the refrigerator compartment door passing through the access door and lay it down, but be careful not to damage the feed water pipe tube.

1) Loosen the hinge cover screws and remove the cover. Remove connection wire, if any, except for the earth line.

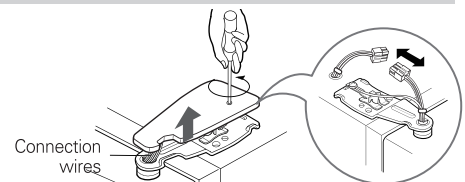

2) Remove keeper by rotating it clockwise (①) and then remove the upper hinge by lifting it up (②).

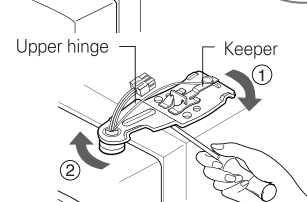

3) Remove the refrigerator compartment door by lifting it up.

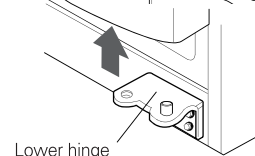

Remove lower cover and then feed water tube

Remove the freezer compartment door

Remove the refrigerator door

Pass the refrigerator

Pass the refrigerator laterally through the access door as shown in the right figure.

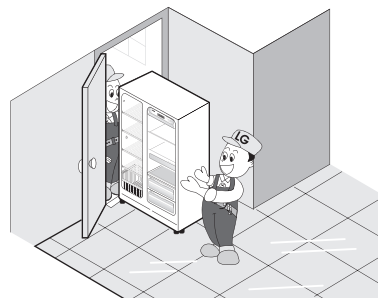

Door replacement

Mount them in the reverse sequence of removal after they pass through the access door.

When the freezer door is lower than the refrigerator door

Insert the transparent sheet supplied with the product when the freezer door is lower than the refrigerator door.

- Separate the door with the lower height, use the (+) type screwdriver to unscrew the screw at the bottom hinge as shown at Figure ①, insert the transparent sheet between the bottom hinge and the bottom bracket, and then fix it with the screw as shown at Figure ②.
- Insert more transparent sheets enough to align the height. (4 sheets are supplied in total.)

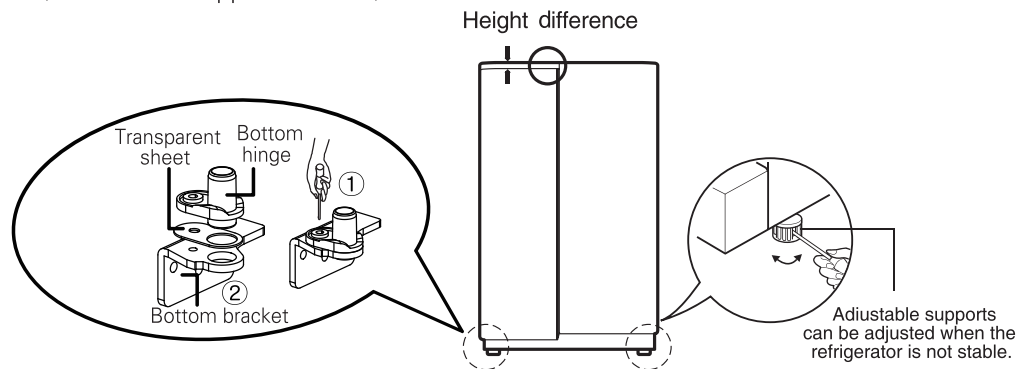

When the refrigerator door is lower than the freezer door

Insert the transparent sheet supplied with the product when the freezer door is lower than the refrigerator door.

- Separate the door with the lower height, use the (+) type screwdriver to unscrew the screw at the bottom hinge as shown at Figure ①, insert the transparent sheet between the bottom hinge and the bottom bracket, and then fix it with the screw as shown at Figure ②.
- Insert more transparent sheets enough to align the height. (4 sheets are supplied in total.)

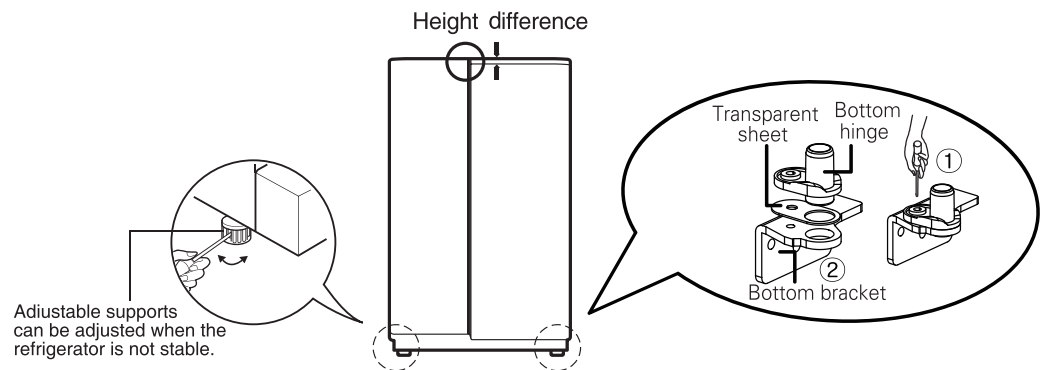

CAUTION

After leveling the door height

Next

Do not over adjust to level the height. The hinge pin may fall out. (Adjustable range of height is a maximum of 2" (5 cm))

The refrigerator doors will close smoothly by heightening the front side by adjusting the height adjusting screw. If the doors do not close correctly, performance may be affected.

1. Wipe off all dust accumulated during shipping and clean your appliance thoroughly.
2. Install accessories such as the ice cube box, and any covers, etc., in their proper places. They are packed together to prevent possible damage during shipping.
3. Connect the power supply cord (or plug) to the outlet. Don't double up with other appliances on the same outlet.

Starting

When your refrigerator is first installed, allow it to stabilize at normal operating temperatures for 3-4 hours prior to filling it with fresh or frozen foods. If operation is interrupted, wait 5 minutes before restarting.

Adjusting the temperatures and functions

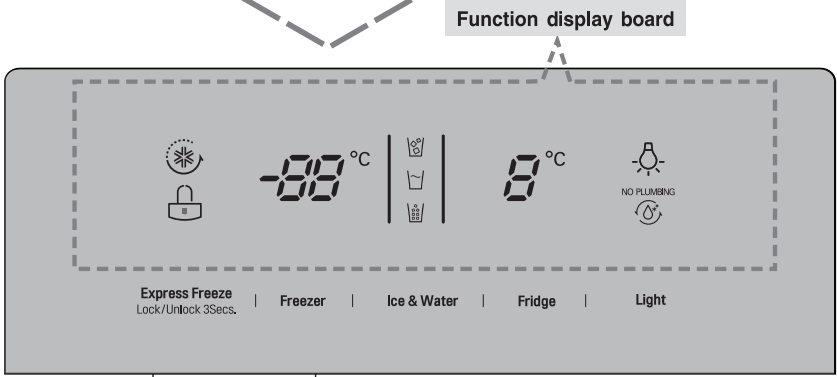
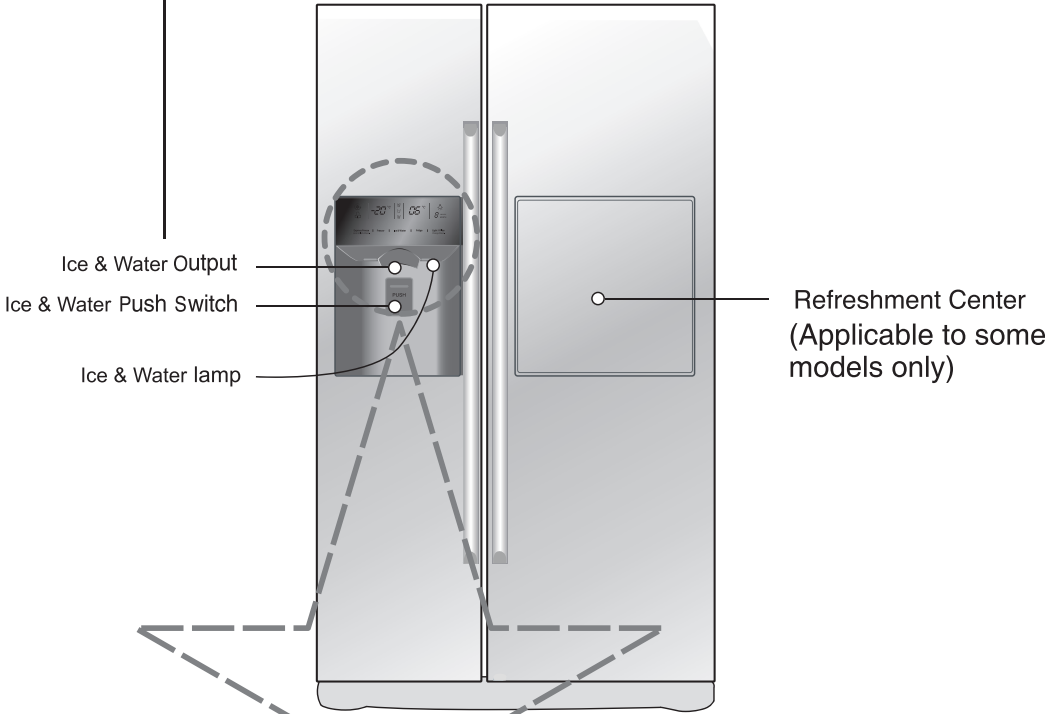

Display Power Saving Mode

NOTE
• Your model may not include every option.

Display Power Saving Mode

This function places the display into power saving mode until the next time the door is opened. Press the Express Freeze and Freezer buttons simultaneously and hold them for 5 seconds until the chimes sound. All LED light will then turn ON, then OFF. When the power saving mode is activated, the display will remain off until the next time the door is opened. Then, it will come on whenever a door is opened or a button is pressed and remain on for 20 seconds after the last door opening or button selection. To deactivate the power saving mode, press the Express Freeze and Freezer buttons simultaneously and hold them for 5 seconds until the chimes sound.

You can adjust temperature of the freezer room and refrigerator room.

How to adjust the temperature in the freezer compartment

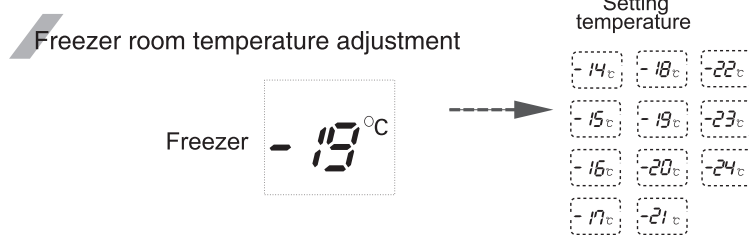

※ Whenever pressing ^{Freezer} button, setting is repeated in the order of (-19°C → -20°C → ... → -24°C → -14°C → ... → -19°C).

How to adjust the temperature in the refrigerator compartment

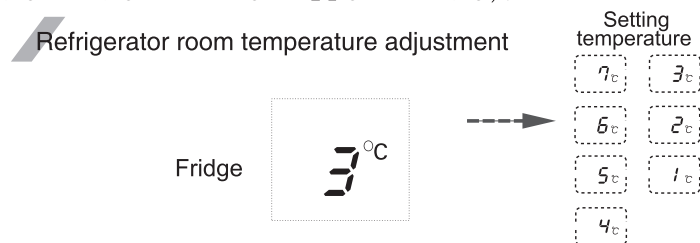

※ Whenever pressing ^{Fridge} button, setting is repeated in the order of (3°C → 2°C → ... → 1°C → 7°C → ... → 3°C).

NOTE:

- The actual inner temperature varies depending on the food status, as the indicated temperature is a target temperature, not actual temperature within refrigerator.
- The refrigerator temperature will take 1~2 days to stabilize after initial installation, therefore it is recommended to adjust temperature as above after using refrigerator for minimum 1~2 days.

Express freezer

Please select this function for express freezer.

- "on" and "off" is repeated whenever pressing "Express Freeze" Lock/Unlock 3Secs. button.
- The Express Freeze display will illuminate when selected.
- If the Express Freeze is "ON", press the button again to turn it off, or it will automatically turn off after the Express Freeze function has completed.

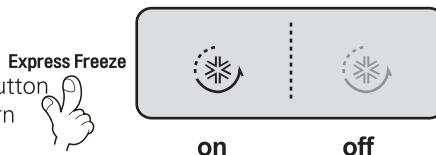

Child Lock

When engaged, the lock function prevents other display settings from being changed.

NOTE: It does not stop water or Ice from dispensing.

- Locking or Release is repeated whenever the button is held pressed for more than 3 seconds
- When you use the "Express Freeze" Lock/Unlock 3Secs. button, you cannot select or change any other setting until you unlock the unit. If any button is pressed while the Child Lock is engaged, the  will flash 3 times to indicate the locked condition.

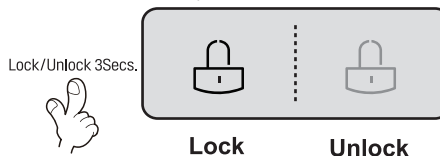

No Plumbing

- This indication is just printing, it can not be operating.



Dispenser use selection

You can select water or ice.

- * You can select water, crushed ice, or cubed ice by pressing the **Ice & Water** button.
- * To dispense water or ice, use a glass or cup and press against the dispenser trigger lever.
 - The Ice duct will remain open for 5 seconds after ice stops dispensing, and a soft motor noise will be heard when it closes.
 - **Reference :** To receive all the dispensed water and ice, please wait for 2~3 seconds before completely removing glass or cup after releasing the dispenser trigger lever.

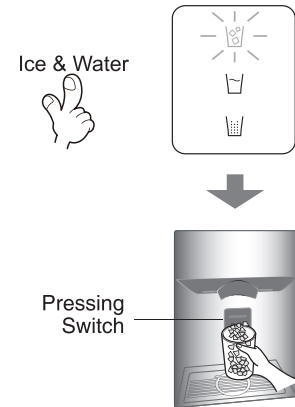

Automatic ice maker

- The icemaker can automatically make 8 pieces of ice cubes at any one time, approximately 16~64 pieces per day. However these quantities may vary according to certain conditions. E.g. the duration and amount of times the refrigerator door is opened.
- The Ice making proceeds ceases automatically when the ice storage bin is full.
- If you choose not to use the automatic ice making function, repositioned the icemaker selection switch to the off position or the on position for reselection. Note: The manual selection function is only applicable to some models only.

NOTE

It is normal that a noise is produced when ice made is dropped into the ice storage bin.

Ice maker cover (Optional)

When you use the ice maker, please remove the cover from door and keep it in the door basket or other place.

When you don't use the ice maker, please put on the cover and turn off the ice maker by the switch, then remove all the ice in the bucket ice.

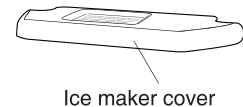

When ice maker does not operate smoothly

Ice is lumped together

- When ice is lumped together, take the ice lumps out of the ice storage bin, break them into small pieces, and then place them into the ice storage bin again.

* Lumped ice can also result if the freezer set temperature is too warm.

It can also cause the ice dispensing to temporarily stop if the thermal protection within dispensing motor is activated. Should this occur, allow at least one hour before trying to dispense ice after removing any lumped cubes.

Power failure

- During a prolonged power failure, the ice in the storage bin may melt and flow into the freezer compartment or leak from the dispenser funnel. Should this begin to occur, remove the ice storage bin and empty out all the ice. It should then be dried with a soft cloth along with any other leakage and refitted into the freezer.

The unit is newly installed

- It takes about 12 hours for a newly installed refrigerator to make ice in the freezer compartment, provided that the conditions are favourable.

The other functions

Door open warning

- Three beeps will sound at 30 second intervals if either of the refrigerator doors remain open or are not completely closed after 1 minute.
- Please contact your service provider if the 3 warning beeps continue to sound even after closing the doors.

Diagnosis (failure detection) function

- The inbuilt diagnostic function automatically detects certain faults during the refrigerators operation.
- If a fault is detected during operation, the display cannot be changed by pressing any button. The display will then show an Error indication and the refrigerator will continue to operate at a predetermined setting. Should an error be displayed, do not turn off the refrigerator as it will increase the time it takes for the Serviceman to diagnose any possible fault.

CAUTION

Throw away the first 20 pieces of ice and discard the first 7 glasses of water first dispensed after the refrigerator is installed .

The first ice and water may include particles or odor from the feed water pipe or feed water tank .This is necessary in case that the refrigerator has not been used for a long time.

Keep children away from the dispenser.

Be careful that food items and packaging do not block the entrance of the ice passage.

If foods are placed at the entrance of ice passage, ice may not be dispensed. The ice passage may also be covered with ice powder if crushed ice is used only. Remove any powdered ice accumulated within the ice passage.

Never store beverage cans or other foods in ice storage bin for the purpose of rapid cooling.

Such actions may damage the automatic ice maker.

Never use thin crystal glass or crockery to collect ice.

Such glasses or containers may be broken.

Put ice first into a glass before filling it with water or other beverages.

Never place your hands or other tools on ice outlet.

Doing so may cause a part breakage or hand injury.

Ice cubes in the icemaker may often require leveling as they may pile up near the ice detection arm which allows the icemaker to perceive that the icebin is full and will then stop making ice.

If discolored ice is dispensed, immediately contact service center, stopping use.

Never use deep or narrow glasses to catch dispensing ice.

Ice may be jammed in ice passage and, thus, the icemaker can malfunction.

Keep the glass at a proper distance from ice outlet.

A glass too close to the outlet may hinder ice from coming out.

If power is cut for long time, please remove the ice in ice storage bin.

When power is cut for long time , the ice in ice storage bin may melt and the melted water may flow out of the freezer and damage the floor. Please remove all ice from the icebin during a prolonged power failure, or when on holiday.

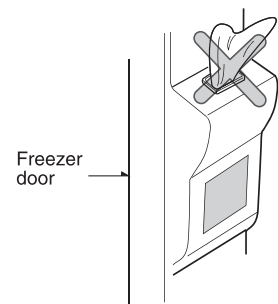

Refreshment center (Feature not available in all countries)

How to use the Home Bar

1. Press the top central part of the Home Bar door until you hear the "Click" sound.

- The home bar allows you to save energy by not having to open the refrigerator door every time.

- It also allows convenience of access to frequently used bottles or containers without opening the refrigerator door.

- When closing the Home Bar door, press until you hear the "Click" sound.

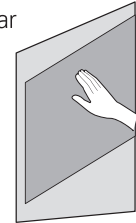

Press until you hear the "Click" sound

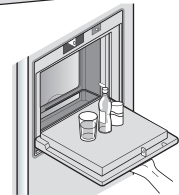

2. Use the opened Home Bar door as a convenient support board for bottles and glasses only.

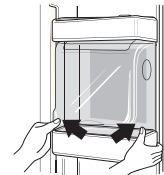

How to disassemble the fridge Home Bar cover

First separate the upper door basket of the Home Bar (①) and then pull up the Home Bar cover (②).



Precaution

1. Do not use the Home Bar with the Home Bar cover removed.

- If the cover is taken out, the Home Bar function cannot work safely or efficiently.



2. Be careful not to damage the Home Bar door when opened or closed.

- Do not allow children to swing, or hang from the opened HomeBar door. Do not place heavy objects or apply excessive pressure onto the open Home Bar door when using it as a support board.

- Do not use the support board as a cutting board or use sharp tools on the support board to prevent any scratches.

- Clean any spillages from the Home Bar door before closing it.

- Failing to follow these instructions can cause damage to the unit and injury to persons especially children.

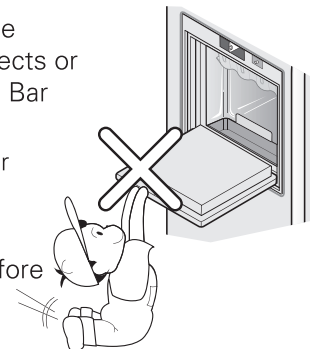

Shelf

How to use

You can store side dish or refrigerated food on the shelf with sufficient space in between the containers.



How to disassemble

1. Lift up the back side of the shelf ①

2. Pull out the shelf ②

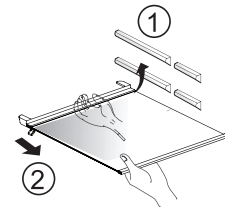

Egg box (Applicable to some models only)

You can move the egg box to wherever you want.

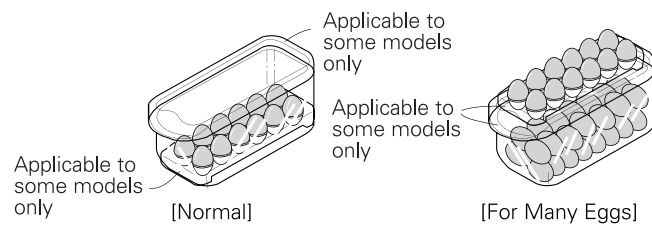

! CAUTION

- Never use the egg box as an ice storage bin. It can be broken.
- Never store the egg box in the freezer compartment or fresh compartment.

Deodorizer (Applicable to some models only)

This system efficiently absorbs strong odors by using the optical catalyst. This system does not have any effect on stored food. The deodorizer should be replaced when it is no longer able to filter odors effectively.

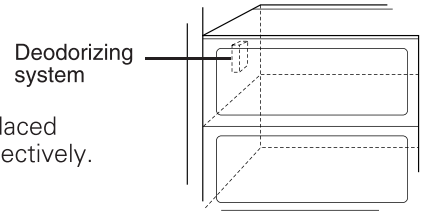

How to use the deodorizing system

- The deodorizer is already installed into the return air guide of the refrigerator located in the rear left corner behind the top crisper draw.
- Please use closed containers to store food with pungent odors. Otherwise, this odor can be absorbed by other food in the compartment.

Freezer Compartment

If a large quantity of food is to be placed in the freezer compartment.

- The drawer of freezer compartment can be taken out of the appliance and the food can be stacked directly on the shelf & bottom of freezer compartment .

- The Freezer compartment also provides shelves to maximise the food storage capacity. The drawers should be used when storing items with high moisture content.

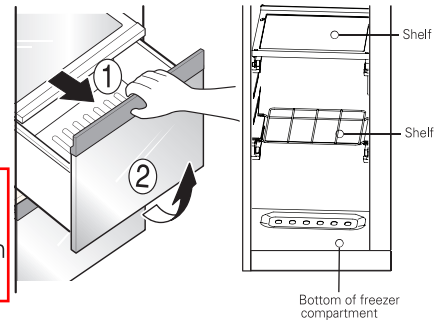

Location of foods

(Refer to identification of parts)

Freezer compartment shelf

Store various frozen foods such as meat, fish, ice cream, frozen snacks, etc..

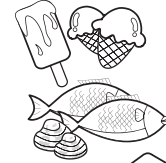

Freezer compartment door rack

- Store small packed frozen food.
- Temperature is likely to increase as door opens. So, do not store long-term food such ice cream, etc..



Freezer compartment drawer

- Store meat, fish, chicken, etc.. after wrapping them with thin foil.
- Store dry.

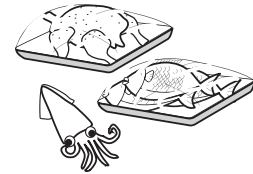

Milk product corner

Store milk products such as butter, cheese, etc..



Egg box

Place this egg box in the proper location.



Refreshment center

Store foods of frequent use such as beverage, etc..



Refrigerator compartment shelf

Store side dishes or other foods at a proper distance.

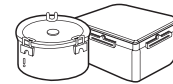

Refrigerator compartment door rack

Store small packed food or beverages such as milk, juice, beer, etc..



Vegetable drawer

Store vegetable, fruits, meat to thaw, raw fish, etc..



Storing foods

Freezer compartment

- Store fresh food in the refrigerator compartment. How food is frozen and thawed is an important factor in maintaining its freshness and flavor.
- Do not store food which goes bad easily at low temperatures, such as bananas, and melons.
- Allow hot food to cool prior to storing, placing hot food in the refrigerator could spoil other food, and lead to higher energy consumption.
- When storing the food, cover it with vinyl wrap or store in a container with a lid. This prevents moisture from evaporating, and helps food to keep its taste and nutrients.
- Do not block air vents with food. Smooth circulation of chilled air keeps refrigerator temperatures even.
- Do not open the door frequently. Opening the door lets warm air enter the refrigerator, and cause temperatures to rise.
- Never keep too much food in door rack because they may push against by inner racks so that the door cannot be fully closed.
- Do not store bottles in the freezer compartment - they may break when frozen.
- Do not refreeze food that has been thawed. This causes loss of taste and nutrient.
- When storing frozen food like ice cream for a long period, place it on the freezer shelf, not in the door basket.
- Do not touch cold foods or containers- especially made of metal , with wet hands or place glass products in the freezer compartment.



CAUTION

- Frostbite or personal injury can occur when frozen foods or internal freezer parts are touched with bare hands.

Refrigerator compartment

- Avoid placing moist food in top refrigerator shelves, it could freezing by direct contact with chilled air.
- Always clean food prior to refrigeration. Vegetables and fruits should be washed and wiped, and packed food should be wiped, to prevent adjacent food from spoiling.
- When storing eggs in their storage rack or box, ensure that they are fresh, and always store them in an upright position, which keeps them fresh longer.

NOTE

- If you keep the refrigerator in a hot and humid place, frequent opening of the door or storing a lot of vegetables in it may cause condensation to form which has no effect on its performance. Remove any dew or condensation with a soft dust free cloth.

How to dismantle parts

NOTE

- Dismantling is done in the reverse sequence of assembly.
Be sure to unplug the power plug before dismantling and assembly.
Never apply severe force to dismantle parts. Parts may be damaged.

Freezer compartment shelf

To remove a shelf, push the shelf to the left ②, lift the left part of the shelf a bit ①, lift the right part up ③, and take it out.

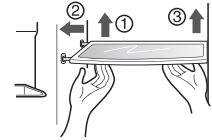

Door rack and support

Lift the door rack holding both sides ① and pull it out to ② direction.

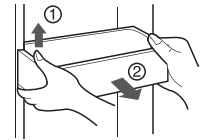

Space plus

Lift the space plus ① and pull it out to ② direction.

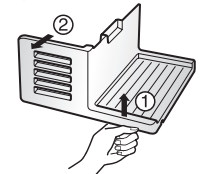

Ice storage bin

Hold the ice storage bin as shown in the right figure and pull it out ② while slightly lifting it ①.

- It is recommended not to dismantle the ice storage bin unless it is necessary.
- Be sure to use both hands when removing the ice storage bin, so as not to drop it on the floor.
- If the ice storage bin does not fit well, slightly rotate the rotating device.

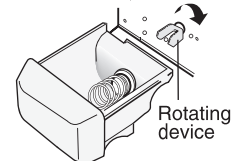

After dispenser is used

The water collector has no self-draining function. It should be cleaned regularly.

First take out the water collector cover. Press the cover where PUSH marked ① to lift the water collector cover up. Take out the water collector cover as shown in picture ②.

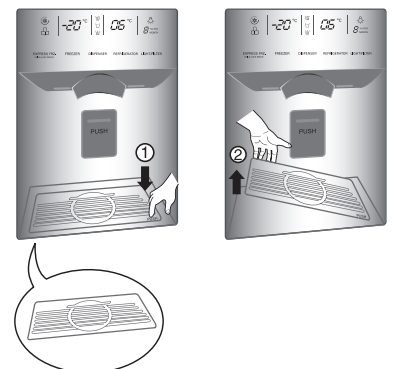

Refreshment center

- Separate the door rack ① to upward.
- Separate cover of the refreshment center ② to upward.
- The door rack ③ can be removed by pulling it upwards.

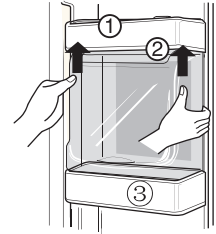

NOTE

Be sure to remove parts from the refrigerator door when removing the vegetable compartment, snack drawer and refreshment center cover.

Vegetable compartment cover

- To remove the vegetable compartment cover, pull out the vegetable compartment to the front (①), lift the back part of the vegetable compartment cover as shown by (②), and take it out.

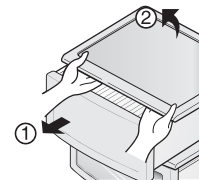

Ice Maker

- Turn off the Ice maker switch (off) after removing the **Space plus**, if you are on a long term vacation or do not wish to use the ice making function. Turn the Ice maker switch back to the on position to resume ice making. Allow a further 24hrs for ice to be made.

General information

Vacation time

During average length vacations, you will probably find it best to leave the refrigerator in operation. Place freezable items in freezer for longer life.

When you plan not to operate, remove all food, disconnect the power cord, clean the interior thoroughly, and leave each door OPEN to prevent odor formation.

Power failure

Most power failures that are corrected in an hour or two will not affect your refrigerator temperatures.

However, you should minimize the number of door openings while the power is off.

If you move

Remove or securely fasten down all loose items inside the refrigerator.

To avoid damaging the height adjusting screws, turn them all the way into the base.

Anti condensation pipe

The outside wall of the refrigerator cabinet may sometimes get warm, especially just after installation.

Don't be alarmed. This is due to the anti-condensation pipe, which pumps hot refrigerator to prevent "sweating" on the outer cabinet wall.

Cleaning

It is important that your refrigerator be kept clean to prevent undesirable odors. Spilled food should be wiped up immediately, since it may acidify and stain plastic surfaces if allowed to settle.

Exterior

Use a lukewarm solution of mild soap or detergent to clean the durable finish of your refrigerator.

Wipe with a clean damp cloth and then dry.

For products with a stainless steel exterior, use a clean sponge or soft cloth and a mild detergent in warm water. Do not use abrasive or harsh cleaners. Dry thoroughly with a Soft cloth. Do not use appliance wax, bleach, or other products containing chlorine on stainless steel.

Interior

Regular cleaning is recommended. Wash all compartments with a baking soda solution or a mild detergent and warm water. Rinse and dry.

After cleaning

Please verify that the power cord is not damaged, power plug is not overheated, and that the power plug is well inserted into the power outlet.

WARNING

Always remove power cord from the wall outlet prior to cleaning in the vicinity of electrical parts (lamps, switches, controls, etc.).

Wipe up excess moisture with a sponge or cloth to prevent water or liquid from getting into any electrical part and causing an electric shock.

Never use metallic scouring pads, brushes, coarse abrasive cleaners, strong alkaline solutions, flammable or toxic cleaning liquids on any surface.

Do not touch frozen surfaces with wet or damp hands, because damp object will stick or adhere to extremely cold surfaces.

Trouble shooting

Before calling for service, review this list. It may save you both time and expense. This list includes common occurrences that are not the result of defective workmanship or materials in this appliance.

Occurrence	Possible cause	Solution
Runing of refrigerator		
Refrigerator compressor does not run.	Refrigerator control is off.	Set refrigerator control. See setting the controls.
	Refrigerator is in defrost cycle.	This is normal for a fully automatic defrosting refrigerator. The defrost cycle occurs periodically.
	Plug at wall outlet is disconnected.	Make sure plug is tightly pushed into outlet.
	Power outage. Check house lights.	Call your local Energy provider
Refrigerator runs too often or too long	Refrigerator is larger than the previous one you owned.	This is normal. Larger, more efficient units run longer in these conditions.
	Room or outside weather is hot.	It is normal for the refrigerator to work longer under these conditions.
	Refrigerator has recently been disconnected for a period of time.	It takes some hours for the refrigerator to cool down completely.
	Large amounts of warm or hot food may have been stored recently.	Warm food will cause the refrigerator to run longer until the desired temperature is reached.
	Doors are opened too frequently or too long.	Warm air entering the refrigerator causes it to run longer. Open the door less often.
	Refrigerator or freezer door may be slightly open.	Make sure the refrigerator is level. Keep food and containers from blocking door. See problem section. OPENING/CLOSING of doors.
	Refrigerator control is set too cold.	Set the refrigerator control to a warmer setting until the refrigerator temperature is satisfactory.
	Refrigerator or freezer gasket is dirty, worn, cracked, or poorly fitted.	Clean or change gasket. Leaks in the door seal will cause refrigerator to run longer in order to maintain desired temperatures.
Sensors are keeping the refrigerator at a constant temperature.	This is normal. Refrigerator goes on and off to keep the temperature constant.	

Occurrence	Possible cause	Solution
Refrigerator compressor does not run.	Sensors are keeping the refrigerator at a constant temperature.	This is normal. The refrigerator goes on and off to keep the temperature constant.
Temperatures are too cold		
Temperature in the freezer is too cold but the refrigerator temperature is satisfactory.	Freezer control is set too cold	Set the freezer control to a warmer setting until the freezer temperature is satisfactory.
Temperature in the refrigerator is too cold and the freezer temperature is satisfactory.	Refrigerator control is set too cold.	Set the refrigerator control to a warmer setting
Food stored in drawers freezes.	Refrigerator control is set too cold.	See above solution.
Meat stored in fresh meat drawer freezes.	Meat should be stored at a temperature just below the freezing point of water (32°F, 0°C) for maximum fresh storage time.	It is normal for ice crystals to form due to the moisture content of meat.
Temperatures are too warm		
Temperatures in the refrigerator or freezer are too warm.	Freezer control is set too warm.	Set the freezer or refrigerator control to a colder setting until the freezer or refrigerator temperature is satisfactory.
	Refrigerator control is set too warm. Refrigerator control has some effect on freezer temperature.	Set the freezer or refrigerator control to a colder setting until the freezer or refrigerator temperature is satisfactory.
	Doors are opened too frequently or too long.	Warm air enters the refrigerator/ freezer whenever the door is opened. Open the door less often.
	Door is slightly open.	Close the door completely.
	Large amounts of warm or hot food may have been stored recently.	Wait until the refrigerator or freezer has a chance to reach its selected temperature.
	Refrigerator has recently been disconnected for a period of time.	A refrigerator requires some hours to cool down completely.
Temperature in the refrigerator is too warm but the freezer temperature is satisfactory.	Refrigerator control is set too warm.	Set the refrigerator control to a colder setting.

Occurrence	Possible cause	Solution
Sound and noise		
Louder sound levels when refrigerator is on.	Today's refrigerators have increased storage capacity and maintain more even temperatures.	It is normal for sound levels to be higher, provided that the performance is not compromised.
Louder sound levels when compressor comes on.	Refrigerator operates at higher pressures during the start of the ON cycle.	This is normal. The sound will level off as the refrigerator continues to run.
Vibrating or rattling noise.	Floor is uneven or weak. Refrigerator rocks on the floor when it is moved slightly.	Be sure floor is level and solid and can adequately support refrigerator.
	Items placed on the top of the refrigerator are vibrating.	Remove items.
	Dishes are vibrating on the shelves in the refrigerator.	It is normal for dishes to vibrate slightly. Move dishes slightly. Make sure refrigerator is level and firmly set on floor.
	Refrigerator is touching wall or cabinets.	Move refrigerator so that it does not touch the wall or refrigerator.
Water/Moisture /Ice inside refrigerator		
Moisture collects on the inside walls of the refrigerator.	The weather is hot and humid which increases the rate of frost buildup and internal sweating.	This is normal.
	Door is slightly open.	See problem section opening/closing of doors.
	Door is opened too often or too long.	Open the door less often.
Water/Moisture /Ice outside refrigerator		
Moisture forms on the outside of the refrigerator or between doors.	Weather is humid.	This is normal in humid weather. When humidity is lower, the moisture should disappear.
	Door is slightly open, causing cold air from the inside the refrigerator to meet warm air from the outside.	This time, close the door completely.

Occurrence	Possible cause	Solution
Odors in refrigerator		
	Interior needs to be cleaned.	Clean interior with sponge,warm water and baking soda.
	Food with strong odor is in the refrigerator.	Deodorizer needs to be cleaned or replaced
	Some containers and wrapping materials produce odors.	Use a different container or brand of wrapping materials.
Opening/Closing of doors/Drawers		
Door(s) will not close.	Food package is keeping door open.	Move packages that keep door from closing.
Door(s) will not close.	Door was closed too hard, causing other door to open slightly.	Close both doors gently.
	Refrigerator is not level. It rocks on the floor when it is moved slightly.	Adjust the height adjusting screw.
	Floor is uneven or weak. Refrigerator rocks on the floor when it is moved slightly.	Be sure floor is level and can adequately support refrigerator. Contact carpenter to correct sagging or sloping floor.
	Refrigerator is touching wall or cabinets.	Move refrigerator..
Drawers are difficult to move.	Food is touching shelf on top of the drawer	Keep less food in drawer.
	Track that drawer slides on is dirty.	Clean drawer and track.
Dispenser		
Dispenser will not dispense ice	Ice storage bin is empty.	When the first supply of ice is dropped into the bin, the dispenser should operate.
	Freezer temperature is set too warm.	Turn the freezer control to a higher setting so that ice cubes will be made. When the first supply of ice is made, the dispenser should operate.
	Household water line valve is not open.	Open household water line valve and allow sufficient time for ice to be made. When ice is made, dispenser should operate.
	Refrigerator or freezer door is not closed.	Be sure both doors are closed.
	Dispenser motor may have thermally cut out and temporarily stopped.	Wait 1 hour before attempting to dispense ice again,Check ice bin for any lumped ice.

Occurrence	Possible cause	Solution
Dispenser will not dispense ice.	Ice has melted and frozen around auger due to infrequent use, temperature fluctuations and/or power outages	Remove ice storage bin, and thaw and the contents. Clean bin, wipe dry and replace in proper position. When new ice is made, dispenser should operate.
Ice dispenser is jammed.	Ice cubes are jammed between the ice maker arm and back of the bin.	Remove the ice cubes that are jamming the dispenser.
	Ice cubes are frozen together.	Use the dispenser often so that cubes do not freeze together.
	Ice cubes that have been purchased or made in some other way have been used in the dispenser.	Only the ice cubes made by the ice maker should be used with the dispenser.
Dispenser will not dispense water.	Water bottle is low or empty.	refill water bottle with potable water.
	Refrigerator or freezer door is not closed.	Be sure both doors are closed.
Water has an odd taste and/or odor.	Water has been in the tank for too long.	Draw and discard 7 glasses of water to freshen the supply. Draw and discard an additional 7 glasses to completely rinse out tank.
	Unit not properly connected to cold water line.	Connect unit to cold water line which supplies water to kitchen tap.
Sound of ice dropping	This sound is normally made when automatically made ice is dropped into ice storage bin. Noise may vary according to refrigerator's location, however this is normal.	
Sound of water supply	This sound is normally made when the auto ice maker is supplied with water after dropping the ice it has made. This is called "harvesting".	
Other	Please thoroughly read 'Automatic ice maker and dispenser' in this manual.	
Not making enough ice	Water tank may be low or empty.	Re refill the water tank.
	Freezer set temperature is too warm.	Makesure the freezer set temperature is cold than - 18°C. (-19°C,-20°C,-21°C,-22°C,-23°C)
	Ice requirement is greater than ice production.	Please refer to page 21 for ice making quantity and operation.

It is Normal...

The following occurrences are normal.

	Occurrence	Solution
Noise	When you hear "Tak" or "Took" sound	This is the sound of various parts expanding/contracting or various control devices operating depending on the temperature change within the refrigerator.
	When you hear "Deureureuk~", "Dulkuk" or "Woong" sound	This is the compressor or fan operating when the operation of the refrigerator is starting or ending. This is the same phenomenon of the sound generated when starting or turning off the engine of a car.
	When you hear "Kureureuk" sound of water flowing	This is the sound of refrigerant changing the condition in the freezer/fridge. When the liquid changes to gas, you will hear the sound of water flowing and when gas changes to liquid, you will hear the "Kureureuk" sound.
	When you hear the sound of wind such as "Shoo~" or "Shik" right after you close the door	This is the sound generated when the internal pressure is temporarily lowered when the warm air entered through the fridge or freezer is cooled fast.
	When you hear the vibrating sound	If the refrigerator is installed on wooden floor or wooden wall, or if the refrigerator is not leveled properly, the sound can be loud from the vibration.
	When you hear a loud sound after installing the product for the first time	When you operate the refrigerator for the first time, the refrigerator will operate at high speed to cool fast and the sound can seem louder. When the internal temperature falls below a certain level, the noise will subside.
Door open	When the door is slightly opened after closing the door	Depending on the force or speed of closing the fridge or freezer door, the door can open slightly but then will close. Be careful not to close the door too hard.
Icing/ Dew drops	When there is icing or condensation formed on the inner or outer side of the refrigerator	When external air flows into the cool inner surface of the refrigerator, condensation can be formed. Especially, this will happen more easily when you open and close the refrigerator door more frequently. Also if the humidity of the installed location is high or during the rainy season or on a rainy day, condensation can form on the outer side of the refrigerator. This is a natural phenomenon that occurs during humid weather. Wipe the condensation with a dry cloth.
Temperature	When the front side of the refrigerator is warm	Heat pipes are installed around the front part of the refrigerator and on the divider of the freezer and fridge to prevent condensation from forming. The refrigerator may feel warmer after the installation or during summer periods. This is quite normal.

Smart Diagnosis

(Applicable to some models only)

Should you experience any problems with your refrigerator, it has the capability of transmitting data via your telephone to the LG service center. This gives you the capability of speaking directly to our trained specialists. The specialist records the data transmitted from your machine and uses it to analyze the issue, providing a fast and effective diagnosis.

If you experience problems with your refrigerator, call to the LG service center. Only use the Smart Diagnosis feature when instructed to do so by the LG call center agent. The transmission sounds that you will hear are normal and sound similar to a fax machine.

Smart Diagnosis cannot be activated unless your refrigerator is connected to power. If your refrigerator is unable to turn on, then troubleshooting must be done without using Smart Diagnosis.

Using Smart Diagnosis

First, call to the LG service center. Only use the Smart Diagnosis feature when instructed to do so by the LG call center agent.

1. Lock the display. To lock the display, press and hold the Lock button for three seconds. (If the display has been locked for over five minutes, you must deactivate the lock and then reactivate it.)

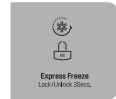

2. Open the right refrigerator door.

3. Hold the mouthpiece of your phone in front of the speaker that is located on the right hinge of the refrigerator door, when instructed to do so by the call center.



4. Press and hold the Freezer Temperature button for three seconds while continuing to hold your phone to the speaker.



5. After you hear three beeps, release the Freezer Temperature button.
6. Keep the phone in place until the tone transmission has finished. This takes about 3 seconds, and the display will count down the time. Once the countdown is over and the tones have stopped, resume your conversation with the specialist, who will then be able to assist you in using the information transmitted for analysis.

NOTE

- For best results, do not move the phone while the tones are being transmitted.
- If the call center agent is not able to get an accurate recording of the data, you may be asked to try again.
- Call quality differences by region may affect the function.
- Use the home telephone for better communication performance, resulting in better service.
- Bad call quality may result in poor data transmission from your phone to the machine, which could cause Smart Diagnosis to not work properly.

