



ENGLISH

OWNER'S MANUAL

# Micro Hi-Fi System

Please read this manual carefully before operating your set and retain it for future reference.

CM2440 (CM2440, CMS2440F)



MFL68006533

# Safety Information



**CAUTION:** TO REDUCE THE RISK OF ELECTRIC SHOCK DO NOT REMOVE COVER (OR BACK) NO USER-SERVICEABLE PARTS INSIDE REFER SERVICING TO QUALIFIED SERVICE PERSONNEL.



This lightning flash with arrowhead symbol within an equilateral triangle is intended to alert the user to the presence of uninsulated dangerous voltage within the product's enclosure that may be of sufficient magnitude to constitute a risk of electric shock to persons.



The exclamation point within an equilateral triangle is intended to alert the user to the presence of important operating and maintenance (servicing) instructions in the literature accompanying the product.

**WARNING:** TO PREVENT FIRE OR ELECTRIC SHOCK HAZARD, DO NOT EXPOSE THIS PRODUCT TO RAIN OR MOISTURE.

**WARNING:** Do not install this equipment in a confined space such as a book case or similar unit.

**CAUTION:** Do not block any ventilation openings. Install in accordance with the manufacturer's instructions.

Slots and openings in the cabinet are provided for ventilation and to ensure reliable operation of the product and to protect it from over heating. The openings shall be never be blocked by placing the product on a bed, sofa, rug or other similar surface. This product shall not be placed in a built-in installation such as a bookcase or rack unless proper ventilation is provided or the manufacturer's instruction has been adhered to.

**CAUTION:** This product employs a Laser System. To ensure proper use of this product, please read this owner's manual carefully and retain it for future reference. Shall the unit require maintenance, contact an authorized service centre. Use of controls, adjustments or the performance of procedures other than those specified herein may result in hazardous radiation exposure. To prevent direct exposure to laser beam, do not try to open the enclosure.

## CAUTION concerning the Power Cord

Most appliances recommend they be placed upon a dedicated circuit;

That is, a single outlet circuit which powers only that appliance and has no additional outlets or branch circuits. Check the specification page of this owner's manual to be certain. Do not overload wall outlets. Overloaded wall outlets, loose or damaged wall outlets, extension cords, frayed power cords, or damaged or cracked wire insulation are dangerous. Any of these conditions could result in electric shock or fire. Periodically examine the cord of your appliance, and if its appearance indicates damage or deterioration, unplug it, discontinue use of the appliance, and have the cord replaced with an exact replacement part by an authorized service centre. Protect the power cord from physical or mechanical abuse, such as being twisted, kinked, pinched, closed in a door, or walked upon. Pay particular attention to plugs, wall outlets, and the point where the cord exits the appliance. To disconnect power from the mains, pull out the mains cord plug. When installing the product, ensure that the plug is easily accessible.

This device is equipped with a portable battery or accumulator.

**Safety way to remove the battery or the battery from the equipment:** Remove the old battery or battery pack, follow the steps in reverse order than the assembly. To prevent contamination of the environment and bring on possible threat to human and animal health, the old battery or the battery put it in the appropriate container at designated collection points. Do not dispose of batteries or battery together with other waste. It is recommended that you use local, free reimbursement systems batteries and accumulators. The battery shall not be exposed to excessive heat such as sunshine, fire or the like.

**CAUTION:** The apparatus shall not be exposed to water (dripping or splashing) and no objects filled with liquids, such as vases, shall be placed on the apparatus.

#### Disposal of your old appliance



1. When this crossed-out wheeled bin symbol is attached to a product it means the product is covered by the European Directive 2002/96/EC.
2. All electrical and electronic products should be disposed of separately from the municipal waste stream via designated collection facilities appointed by the government or the local authorities.
3. The correct disposal of your old appliance will help prevent potential negative consequences for the environment and human health.
4. For more detailed information about disposal of your old appliance, please contact your city office, waste disposal service or the shop where you purchased the product.

#### **Disposal of waste batteries/accumulators**



1. When this crossed-out wheeled bin symbol is attached to batteries/accumulators of Your product it means they are covered by European Directive 2006/66/EC.
2. This symbol may be combined with chemical symbols for mercury(Hg), cadmium(Cd) or lead(Pb) if the battery Contains more that 0.0005% of mercury,0.002% of cadmium or 0.004% of lead.
3. All batteries/accumulators should be disposed separately from the municipal waste stream via designated collection facilities appointed by the government or the local authorities.
4. The correct disposal of Your old batteries/accumulators will help to prevent potential negative consequences for the environment, animal and human health.
5. For more detailed information about disposal of Your old batteries/accumulators, please contact Your city office, waste disposal service or the shop where You purchased the product.

# Table of Contents

## 1 Getting Started

---

- 2 Safety Information
- 6 Unique Features
- 6 Accessories
- 6 Playable file Requirement
  - 6 – Music file requirement
- 7 – Compatible USB Devices
- 7 – USB device requirement
- 8 Remote control
- 9 Front panel
- 10 Back panel

## 2 Connecting

---

- 11 Connecting the speakers to the unit
  - 11 – Attaching the speakers to the unit
- 11 Antenna Connection
- 12 Optional Equipment Connection
  - 12 – USB Connection
  - 12 – PORT. IN Connection

## 3 Operating

---

- 13 Basic Operations
  - 13 – CD/ USB Operations
  - 14 – Selecting a folder
  - 14 – Deleting an MP3/WMA/FLAC file
  - 15 – Android device Operation
- 16 Radio Operations
  - 16 – Listening to the radio
  - 16 – Presetting the Radio Stations
  - 17 – Deleting all the saved stations
  - 17 – Improving poor FM reception
- 17 Other Operations
  - 17 – Programmed Playback
  - 18 – Displaying file information (ID3 TAG)
  - 18 – Turn off the sound temporarily
  - 18 – Auto Power Down
- 18 Sound adjustment
  - 18 – Setting the surround mode
- 19 Setting the Clock
  - 19 – Setting the clock through "LG Bluetooth Remote" App
  - 19 – Setting the alarm
- 19 Sleep Timer Setting
- 19 Dimmer
- 20 Using Bluetooth technology
  - 20 – Listening to music stored on the Bluetooth devices
  - 21 – Using Bluetooth App

## **4 Troubleshooting**

---

23 Troubleshooting

## **5 Appendix**

---

24 Specifications  
25 Maintenance  
25 - Handling the Unit  
25 - Notes on Discs  
25 Trademarks and Licenses



## Unique Features

### Portable In

Listens to music from your portable device. (MP3, Notebook, etc)

### Bluetooth

Listens to music stored on your bluetooth device.

### LG Bluetooth Remote

You can control this unit with your Android device via Bluetooth. This unit and your device must be paired for Bluetooth. Visit "Google Android Market (Google Play Store)" to search for "LG Bluetooth Remote" app. For detailed information, refer to page 21.

## Accessories

Please check and identify the supplied accessories.

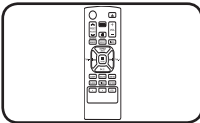

Remote Control (1)

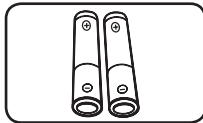

Battery (2)

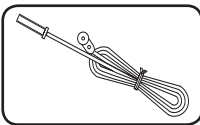

Antenna (1)

## Playable file Requirement

### Music file requirement

MP3/WMA/FLAC file compatibility with this unit is limited as follows :

- Sampling frequency :
  - MP3 : within 8 to 48 kHz
  - WMA : within 8 to 48 kHz
  - FLAC : within 8 to 48 kHz(USB), within 8 to 48 kHz(CD)
- Bit rate : within 8 to 320 kbps (MP3), 40 to 192 kbps (WMA)
- Maximum files : Under 999
- File extensions : ".mp3"/".wma"/".flac"
- CD-ROM file format : ISO9660/ JOLIET
- Support channel(FLAC) : Up to 2 channel
- Support output bit/sample (FLAC) : 16bit
- bps(FLAC) : Up to 2.5Mbps

The DTS is not supported. In case of DTS audio format, audio is not output.

You have to set the disc format option to [Mastered] in order to make the discs compatible with the LG players when formatting rewritable discs. When setting the option to Live File System, you cannot use it on LG players. (Mastered/ Live File System : Disc format system for Windows Vista)

## Compatible USB Devices

- MP3 Player : Flash type MP3 player.
- USB Flash Drive :  
Devices that support USB2.0 or USB1.1.
- The USB function of this unit does not support all USB devices.

## USB device requirement

- Devices which require additional program installation when you have connected it to a computer, are not supported.
- Do not extract the USB device while in operation.
- For a large capacity USB, it may take longer than a few minute to be searched.
- To prevent data loss, back up all data.
- If you use a USB extension cable or USB hub, the USB device is not recognized.
- Using NTFS file system is not supported. (Only FAT(16/ 32) file system is supported.)
- This unit is not supported when the total number of files is 1000 or more.
- External HDD, Card readers, Locked devices, or hard type USB devices are not supported.
- USB port of the unit cannot be connected to PC. The unit cannot be used as a storage device.
- Some USB may not work with this unit.
- In power on state, you can charge your Android device via USB port. (This is available when you select USB function.)

## Remote control

1  
Getting Started

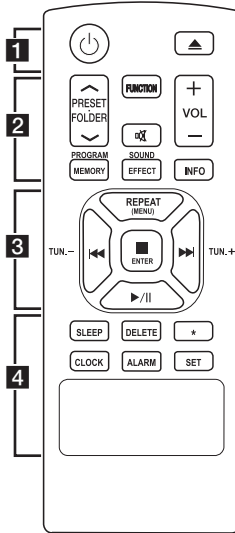

### Battery Installation

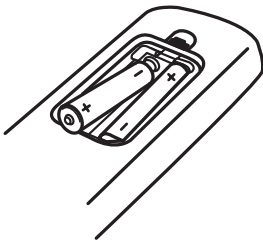

Remove the battery cover on the rear of the Remote Control, and insert two (size AAA) batteries with  $\oplus$  and  $\ominus$  matched correctly.

..... **1** .....

$\text{⏻}$  : Switches the unit ON or OFF.

$\blacktriangle$  : Opens or closes the disc tray.

..... **2** .....

**PRESET-FOLDER  $\wedge$ /V** :

- Searches for a folder of MP3/ WMA files. When a CD/ USB containing MP3/ WMA files in several folders is being played, press **PRESET-FOLDER  $\wedge$ /V** to select the folder you want to play.
- Chooses a preset number for a radio station.

**FUNCTION** : Selects the function and input source.

$\text{⏸}$  : Mutes the sound.

**VOL (Volume)  $\oplus$  /  $\ominus$**  : Adjusts speaker volume.

**PROGRAM/MEMORY** :

- Stores radio stations.
- Creates a playlist you want to listen to.

**SOUND EFFECT** : Chooses sound impressions.

**INFO** : Sees informations about your music. MP3 files often come with ID3 tags. The tag gives the Title, Artist, Album or Time information.

..... **3** .....

**REPEAT(MENU)** : Listens to your tracks/files repeatedly or randomly.

$\text{⏮}/\text{⏭}$  (Skip/Search) :

- Skips Fast backward or Forward.
- Searches for a section within a track/file.

**TUN.  $\ominus$ / $\oplus$**  : Selects the radio station.

**ENTER** :

- Stops playback or recording
- Cancels DELETE function.

$\text{▶}/\text{⏸}$  (Play/Pause) :

- Starts or pauses playback.

- Selects STEREO/MONO.

..... **4** .....

**SLEEP** : Sets the system to turn off automatically at a specified time. (Dimmer : The display window will be darkened by half.)

**DELETE** : Deletes MP3/WMA files.

**\*** : The button is not available for any function.

**CLOCK** : Sets a clock and checks a time.

**ALARM** : Uses your player as an alarm clock.

**SET** : Confirms the clock and the alarm setting.



## Front panel

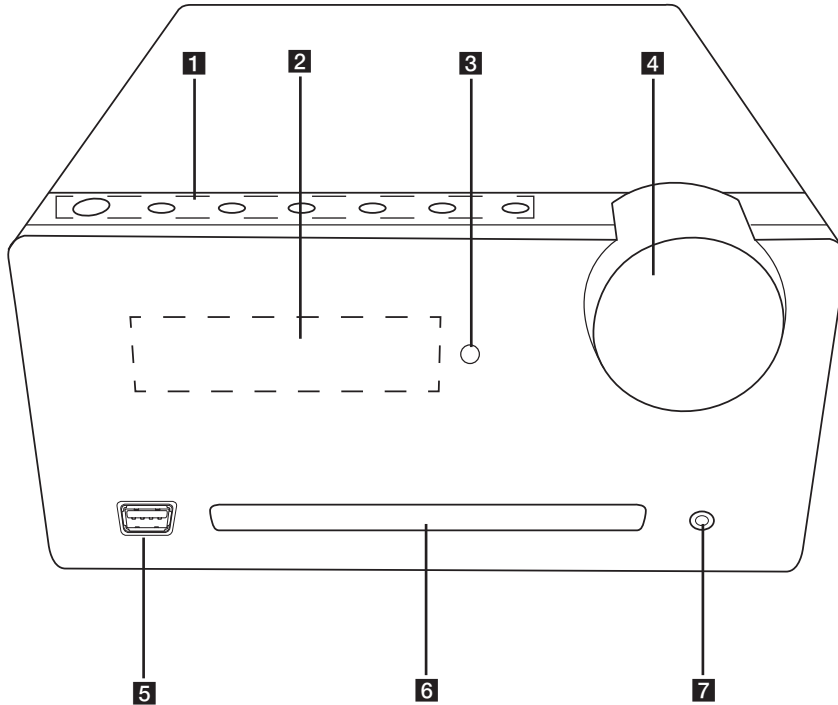

### 1 (Power ON/OFF)

#### **F** (Function)

Selects the function and input source.

#### **⏮/⏭** (skip/Search)

- Searches backward or forward.
- Skips to the previous/next track/file.

#### **TUNING-/+**

Selects the radio stations.

#### **▶||** (Play/Pause)

Starts or pauses playback.

#### **□** (stop)

- Stops playback or recording.
- Cancels DELETE function.

#### **△** (Open/Close)

Opens or closes the disc tray.

### 2 Display Window

### 3 Remote sensor

### 4 Volume Knob

Adjusts volume of speaker.

### 5 USB Port

- Plays and records the audio files by connecting the USB device.
- Plays the audio files using your USB cable for Android.

### 6 Disc tray

### 7 **PORT. IN**

Listens to music from your portable device.

## Back panel

1  
Getting Started

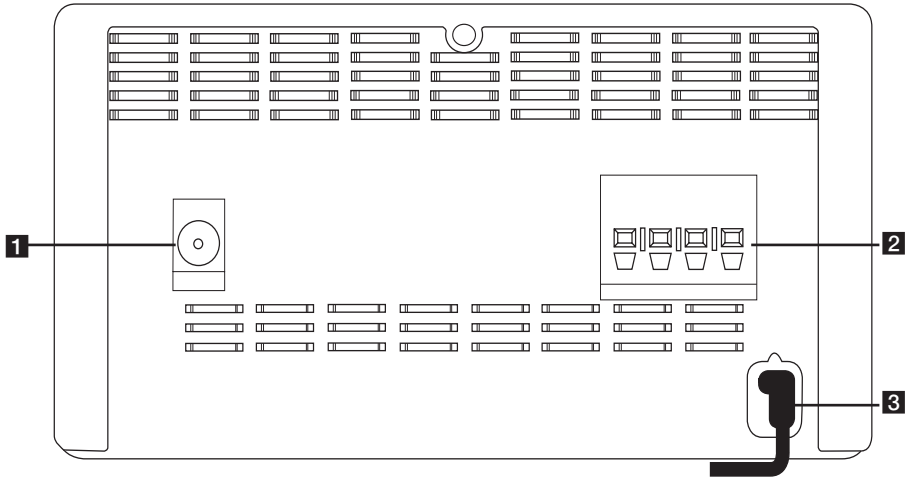

- 1** FM ANTENNA
- 2** SPEAKERS terminal
- 3** POWER IN

## Connecting the speakers to the unit

### Attaching the speakers to the unit

To connect the cable to the unit, press each plastic finger pad to open the connection terminals on the unit. Insert the wire and release the finger pad.

Connect the black stripe of each wire to the terminals marked - (minus) and the other end to the terminals marked + (plus).

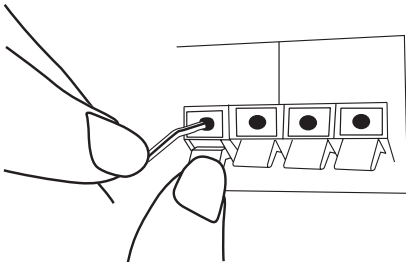

#### Caution

The speakers contain magnet parts, so color irregularity may occur on the TV screen or PC monitor screen. Please use the speakers far away from either TV screen or PC monitor.

## Antenna Connection

Connect the Antenna to the antenna port on the back of the unit. Be sure to extend the FM wire antenna fully.

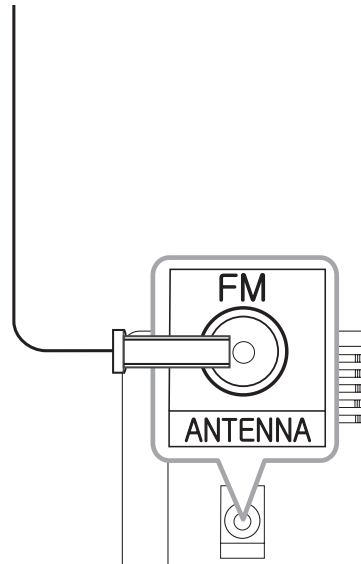

2

Connecting

## Optional Equipment Connection

2  
Connecting

### USB Connection

Connect the USB device (or MP3 player, etc.) to the USB port on the front of the unit.

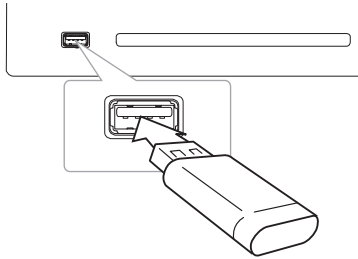

#### ! Note

Removing the USB Device from the unit :

1. Choose a different function/mode or press **ENTER** on the remote control or **ENTER** on the unit twice in a row.
2. Remove the USB device from the unit.

### PORT. IN Connection

Connect an output (earphone or line out) of portable device (MP3 or PMP etc) to the **PORT. IN** connector.

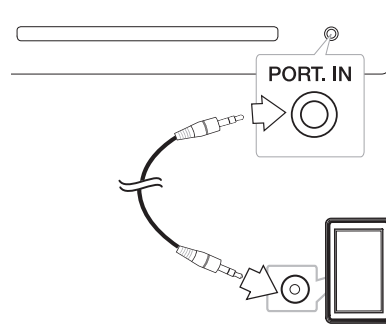

### Listening to music from your external device

This unit can be used to play the music from many types of external device.

1. Connect the external device to the **PORT. IN** connector of the unit.
2. Turn the power on by pressing **POWER** on the remote control or **POWER** on the unit.
3. Select the PORTABLE function by pressing **FUNCTION** on the remote control or **F** on the unit.
4. Turn the external device and start playing music.

## Basic Operations

When you select USB function, you can see messages as follows;

Message	Cause
CHARGE	Your device is not supported by AOA 2.0(Only charging)
Number of files	This unit recognizes your USB.
ANDROID	This unit recognizes your Android device supported by AOA 2.0 as known device.
NO USB	Any device is not connected to USB port. This unit recognizes your Android device as an unknown device.

### ! Note

Depending on the type of device, message will appear in other way.

## CD/ USB Operations

1. Insert the disc by pressing **▲** on the remote control or **△** on the unit.  
Or connect the USB device to the USB port.
2. Select the CD or USB function by pressing **FUNCTION** on the remote control or **F** on the unit.
3. Select a track/file you want to play by pressing **◀◀/▶▶** on the remote control or **|◀◀/▶▶|** on the unit.

To	Do this
Stop	Press <b>■ENTER</b> on the remote control or <b>□</b> on the unit.
Playback	Press <b>▶/  </b> on the remote control or <b>&gt;  </b> on the unit.
Pause	During playback, press <b>▶/  </b> on the remote control or <b>&gt;  </b> on the unit.
Skipping to the next/previous track/file	Press <b>◀◀/▶▶</b> on the remote control or <b> ◀◀/▶▶ </b> on the unit to skip the track/file in stop status.
	During playback, press <b>▶▶</b> on the remote control or <b>&gt;&gt; </b> on the unit to go to the next track/file.
	Playing less than 2 seconds, press <b>◀◀</b> on the remote control or <b> ◀◀</b> on the unit to go to the previous track/file. Playing after 3 seconds, press <b>◀◀</b> on the remote control or <b> ◀◀</b> on the unit to go to the beginning of the track/file.
Searching for a section within a track	Press and hold <b>◀◀/▶▶</b> on the remote control or <b> ◀◀/▶▶ </b> on the unit during playback and release it at the point you want to listen to.
Playing repeatedly or randomly	Press <b>REPEAT(MENU)</b> on the remote control repeatedly, the display changes in the following order. RPT1 -> RPT DIR (only MP3/WMA/FLAC) -> RPT ALL -> RANDOM -> OFF

### ! Note

If you play a scratched disc, there are some noise and the unit cannot read the disc.

## Selecting a folder

1. Press **PRESET-FOLDER**  $\wedge/V$  on the remote control repeatedly until a desired folder appears.
2. Press **▶/||** on the remote control or **>||** on the unit to play it. The first file of folder will play.

### ! Note

- USB and CD Folders/Files are recognized as below.

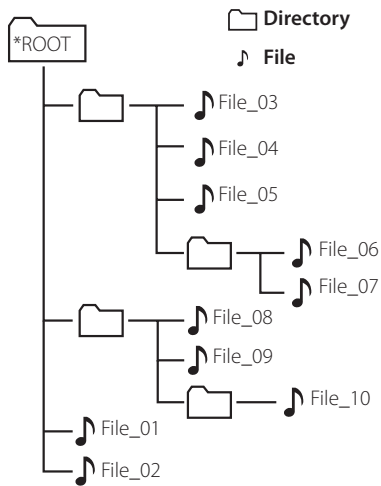

- Files and folders will be presented in order recorded and may be presented differently according to the record circumstances.
- \*ROOT : the first screen you can see when a computer recognize the USB is "ROOT"
- Folders will be presented as the following order;  
FAT(USB), CD : FILE\_01 -> FILE\_02 -> FILE\_03  
-> FILE\_04 -> FILE\_05 -> **FILE\_06** ->  
**FILE\_07** -> **FILE\_08** -> **FILE\_09** -> FILE\_10

## Deleting an MP3/WMA/FLAC file

You can delete file, folder or format by pressing **DELETE** on the remote control. This function is supported only in stop state. (USB only)

1. -Select the file you want to delete and press **DELETE**.

-Select the folder you want to delete by pressing **PRESET-FOLDER**  $\wedge/V$  on the remote control. Then press **DELETE**.

-Press and hold **DELETE** to format the USB device.

Or

Press **DELETE** repeatedly while searching a file.

The display window will be changed in the following order.

- DEL FILE : Deletes file
- DEL DIR?: Deletes folder
- FORMAT? : Formats USB

2. To delete file/folder or format, press **▶/||** on the remote control or **>||** on the unit.
3. If you want to exit the current mode, press **■ ENTER** on the remote control or **□** on the unit

## Android device Operation

You can enjoy the sound from your Android device through USB port. For details about Android device, refer to the Android device User Guide.

To stream audio from your Android device through this unit, you need :

- With Android operation system : Ver 4.1(or later) and AOA 2.0 (or later)
- With a micro USB cable

### ! Note

- It is possible that certain devices may not support or be compliant with the AOA2.0 USB audio standard, resulting in the device freezing or rebooting after being connected and detached from the speaker system. If you experience this problem, please contact your device manufacturer. Your device may need to be updated with the latest Jellybean software and or the correct AOA2.0 USB audio standard.

\*About AOA (Android Open Accessory) 2.0 version ;  
Audio output from Android device to the Accessory and HID (Human Interface Device)

- You are recommended to remove the case for your Android device (Ver4.1 or later) before you connect your Android device to USB port using a cable.

1. Connect Android device to the USB port by using the Android device's cable.

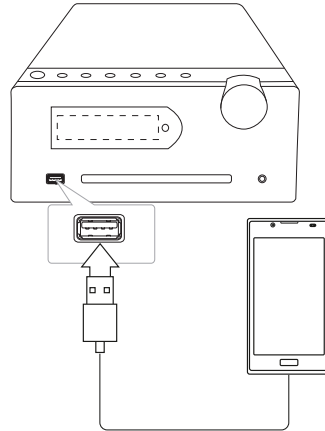

2. Press **FUNCTION** on the remote control or **F** on the unit to select USB function.
3. If your unit is connected firmly, 'ANDROID' will appear in the display window. You can operate your Android device through an Android device's display by using the remote control and controlling your Android device.

To	Do this
Play	Press >  .
Pause	During playback, press >  .
Skip	During playback, press  <</>>  to go to the next file or to return to the beginning of the current file. During playback, press  <<< twice briefly to step back to the previous file.

### ! Note

- If the connection has an error, check these problems as follows;
  - Your Android device is not connected firmly.
  - This unit recognizes your Android device as an unknown device.
  - Your Android device is not booted.
  - Check the setting of USB connection type on your Android device.
- In case of no sound from this unit, adjust the volume of your Android device.
- The charging time may vary depending on your Android device.
- Some Android devices may not be charged.
- You may not control your Android device from this unit due to malfunction of Android device.
- Depending on your Android device's software version, it may not be possible to control your Android device from this unit. We recommend installing the latest software version.
- If your Android device does not support AOA (Android Open Accessory) 2.0 version, this unit can only charge your Android device even though Android device has OS 4.1 (or later).

## Radio Operations

### Listening to the radio

1. Press **FUNCTION** on the remote control or **F** on the unit until TUNER appears on the display window.  
The last received station is tuned in.
2. Auto tuning : Press **TUN.-/+** on the remote control or **|<</>>|** on the unit for about 2 seconds until the existing frequency starts changing, then release. Scanning stops when the unit tunes in a station.  
Manual tuning: Press **TUN.-/+** on the remote control or **|<</>>|** on the unit repeatedly.
3. Adjust the volume by pressing **VOLUME +/-** on the remote control or rotate the Volume Knob on the unit.

### Presetting the Radio Stations

You can preset 50 stations for FM.  
Before tuning, make sure to turn down the volume.

1. Press **FUNCTION** on the remote control or **F** on the unit until TUNER appears on the display window.
2. Select the desired frequency by pressing **TUN.-/+** remote control or **|<</>>|** on the unit.
3. Press **PROGRAM/MEMORY**. A preset number will blink on the display window.
4. Press **PRESET-FOLDER ^/V** to select the preset number you want.
5. Press **PROGRAM/MEMORY**. The station is stored.
6. Repeat steps 2 to 5 to store other stations.
7. To listen a preset station, press **PRESET-FOLDER ^/V**.



## Deleting all the saved stations

1. Press and hold **PROGRAM/MEMORY** for two seconds. "CLEAR" will flash up on the display window.
2. Press **PROGRAM/MEMORY** to erase all saved radio stations.

## Improving poor FM reception

Press **▶/||** on the remote control. This will change the tuner from stereo to mono and usually improve the reception.

## Other Operations

### Programmed Playback

The program function enables you to store your favorite files from any disc or USB device.

A program can contain 20 tracks/files.

1. Insert a CD or a USB and wait for it to be ordered.
2. Press **PROGRAM/MEMORY** on the remote control in stop status.
3. Press **◀◀/▶▶** on the remote control or **|◀/▶|** on the unit to select a track/file.
4. Press **PROGRAM/MEMORY** on the remote control again to save and select a next track/file.
5. Press **▶/||** on the remote control or **>||** on the unit to play the programmed music tracks/files.
6. To clear your selection, press **■ENTER** on the remote control or **□** on the unit twice.

#### Note

The programs are also cleared when the disc or USB device is removed, the unit is powered off or the function is switched to others.

## Displaying file information (ID3 TAG)

While playing an MP3 file containing file information, you can display the information by pressing **INFO**.

## Turn off the sound temporarily

Press **MUTE** on the remote control to mute your unit. You can mute your unit, for example, to answer the telephone, the mute symbol "M" is displayed in the display window.

To cancel it, press again **MUTE** on the remote control or change the volume level.

## Auto Power Down

This unit will be off itself to save electric consumption in the case main unit is not connected to external device and is not used for 20 minutes.

So does this unit after six hours since Main unit has been connected to other device using analog input.

## Sound adjustment

### Setting the surround mode

This system has a number of pre-set surround sound fields. You can select a desired sound mode by using **SOUND EFFECT**.

The displayed items for the Equalizer may be different depending on sound sources and effects.

On Display	Description
AUTO EQ	Sets the sound equalizer on the mode that is the most similar to the genre which is included in the MP3 ID3 tag of song files
POP CLASSIC ROCK JAZZ	This program lends an enthusiastic atmosphere to the sound, giving you the feeling you are at an actual pop, classic or rock concert.
MP3 -- OPT	This function is optimized for compressible MP3 file. It improves the treble sound.
BASS BLAST (BASS)	Reinforces the treble, bass and surround sound effect.
BYPASS	You can enjoy the sound without equalizer effect.

### ! Note

Maybe you need reset the surround mode, after switching the input, sometimes even after the sound track changed.

## Setting the Clock

1. Turn the unit on.
2. Press **CLOCK** for at least 2 seconds.
3. Choose time mode by pressing **◀◀/▶▶** on the remote control or **◀◀/▶▶** on the unit.  
- AM 12:00 (for an AM and PM display)  
or 0:00 (for a 24 hour display)
4. Press **SET** to confirm your selection.
5. Select the hours by pressing **◀◀/▶▶** on the remote control or **◀◀/▶▶** on the unit
6. Press **SET** to confirm your selection.
7. Select the minutes by pressing **◀◀/▶▶** on the remote control or **◀◀/▶▶** on the unit.
8. Press **SET** to confirm your selection.
9. If you want to reset the clock, press and hold **CLOCK**. Then repeat steps 3-8.

## Setting the clock through "LG Bluetooth Remote" App

Install "LG Bluetooth Remote" app on your Android device. (refer to page 21)

Your unit's clock will be automatically synchronized with your device by activating Bluetooth connection through "LG Bluetooth Remote" app.

## Setting the alarm

You can use the unit as an alarm clock.  
You have to set the clock before setting the alarm.

1. Turn the unit on.
2. Press **ALARM**. Each of functions flashes.
3. Press **SET** when the function you want to be woken by is showing.
4. "ON TIME" will be displayed. This is your desired time to the unit turns on. Press **◀◀/▶▶** on the remote control or **◀◀/▶▶** on the unit to change the hours and minutes and press **SET** to save.
5. Press **◀◀/▶▶** on the remote control or **◀◀/▶▶** on the unit to change the volume and press **SET** to save.
6. If you want to reset the alarm, press and hold **ALARM**. Then repeat steps 3-5.

### ! Note

- Alarm function only works when the unit is turned off after setting the alarm.
- If you set the clock time and alarm, you can check the time by pressing **CLOCK** or the alarm by pressing **ALARM** even when the unit is turned off.
- If the alarm is already set, press **ALARM** once to cancel the alarm. To activate the alarm, press **ALARM** once again.
- If the clock time or the alarm is already set, press and hold **CLOCK** or **ALARM** for at least 2 seconds to reset the clock or the alarm.

## Sleep Timer Setting

Press **SLEEP** repeatedly to select delay time sequence from 180 to 10 minutes. After the delay time, the unit will be turned off.

To cancel the sleep function, press **SLEEP** repeatedly until "SLEEP 10" appears, and then press **SLEEP** once again while "SLEEP 10" is displayed.

### ! Note

- You can check the remaining time before the unit is turned off.
- Press **SLEEP**. The remaining time appears in the display window.

## Dimmer

Press **SLEEP** once. The display window will be darkened by half. To cancel it, press **SLEEP** repeatedly until dim off.

## Using Bluetooth technology

### About Bluetooth

Bluetooth is wireless communication technology for short range connection.

The sound may be interrupted when there is interference by the other electronic waves which run on same frequency or if you connect bluetooth devices in the other rooms nearby.

Connecting individual devices under **Bluetooth®** wireless technology does not incur any charges. A mobile phone with **Bluetooth®** wireless technology can be operated via the Cascade if the connection was made via **Bluetooth®** wireless technology.

Available Devices : Mobile phone, MP3, Laptop, PDA etc.

### Bluetooth profiles

In order to use **Bluetooth®** wireless technology, devices must be able to interpret certain profiles. This unit is compatible with following profile.

A2DP (Advanced Audio Distribution Profile)

## Listening to music stored on the Bluetooth devices

### Pairing this unit and Bluetooth device

Before you start the pairing procedure, make sure the Bluetooth feature is turned on in to your Bluetooth device. Refer to your Bluetooth device's user guide. Once a pairing operation is performed, it does not need to be performed again.

1. Select the BT function by using **FUNCTION** on the remote control or **F** on the unit. Then "BT READY" will be on the display window.
2. Operate the Bluetooth device and perform the pairing operation. When searching for this unit with the Bluetooth device, a list of the devices found may appear in the Bluetooth device display depending on the type of Bluetooth device. Your unit appears as "LG Micro(XX:XX)".

#### ! Note

XX:XX means the last four digits of BT address. For example, if your unit has a BT address such as 9C:02:98:4A:F7:08, you will see "LG Micro (F7:08)" on your Bluetooth device.

3. Enter the PIN code.  
PIN code : 0000

#### ! Note

Depending on the Bluetooth device type, some device have a different pairing way.

4. When this unit successfully paired with your Bluetooth device, "BT PAIR" will be on the display window
5. Listen to music.  
To play a music stored on your Bluetooth device, refer to your Bluetooth device's user guide.

#### ! Note

- Sound from the main set can be distorted if you raise the volume of Bluetooth device up to two-thirds or more.
- When you use the bluetooth function, adjust the volume of a bluetooth device to a proper level to listen to.

### ! Note

- When using **Bluetooth®** technology, you have to make a connection between the unit and the bluetooth device as close as possible and keep the distance. However it may not work well in the case below :
  - There is an obstacle between the unit and the bluetooth device.
  - There is a device using same frequency with **Bluetooth®** technology such as a medical equipment, a microwave or a wireless LAN device.
- You should connect your Bluetooth device to this unit again when you restart it.
- When you select Bluetooth function again after changing to other functions, Bluetooth connection may be disconnected. You should reconnect the bluetooth device to use this function.
- The sound may be interrupted when the connection interfered by the other electronic wave.
- You cannot control the Bluetooth device with this unit.
- Pairing is limited one Bluetooth device per one unit and multi-pairing is not supported.
- Depending on the type of the device, you may not be able to use the Bluetooth function.
- You can enjoy wireless system using phone, MP3, Notebook, etc..
- The more distant between the unit and the bluetooth device, the lower the sound quality becomes.
- Bluetooth connection will be disconnected when the unit is turned off or the bluetooth device gets far from the unit.

## Using Bluetooth App

### About “LG Bluetooth Remote” App

“LG Bluetooth Remote” app brings a suite of new features to this unit.

To enjoy more features, you are recommended to download and install free “LG Bluetooth Remote” app.

### Install “LG Bluetooth Remote” App through “Google Android Market (Google Play Store)”

1. Tap the “Google Android Market (Google Play Store)” icon.
2. In the search bar, type in the “LG Bluetooth Remote” and search it.
3. In the search result list, find and tap “LG Bluetooth Remote” to start downloading Bluetooth app.
4. Tap an icon for installation.
5. Tap an icon for downloading.

### ! Note

- Make sure that your Bluetooth device is connected to the Internet.
- Make sure that your Bluetooth device is equipped with “Google Android Market (Google Play Store)”.
- If you want to get more information, refer to explanation of BT app in “Google Android Market (Google Play Store)”.

## Activate Bluetooth with “LG Bluetooth Remote” App

“LG Bluetooth Remote” app helps to connect your bluetooth device to this unit.

1. Tap “LG Bluetooth Remote” app icon on the home screen to open “LG Bluetooth Remote” app, and go to the main menu.
2. Tap [Setting] and select the unit you want.
3. If you want to get more information to operate, tap [Setting] and [Help].

### ! Note

- BT app will be available in the software version as follow;
  - Android O/S : Ver 2.3.3 (or later)
- This unit does not support the multi-pairing. If this unit is already connected with other Bluetooth device, disconnect that device and then try again
- If you use “LG Bluetooth Remote” app for operation, there would be some differences between “LG Bluetooth Remote” app and the supplied remote control. Use the supplied remote control as necessary.
- Depending on the Bluetooth device, “LG Bluetooth Remote” app may not work.
- The connection you’ve made may be disconnected if you select other application or change the setting of the connected device via “LG Bluetooth Remote” app. In such a case, please check the connection status.
- To prevent a malfunction, you are recommended to connect only one device to this unit.
- Don’t connect your smart device by using a cable to USB port. Or else the Bluetooth connection will be disconnected.
- After connection of BT app, music may be output from your device. In this case, try connecting procedure again.

# Troubleshooting

Problem	Cause & Correction
No Power.	<ul style="list-style-type: none"> <li>• The power cord is not plugged in. Plug in the power cord.</li> <li>• Check whether electricity failed. Check the condition by operating other electronic devices.</li> </ul>
No sound.	<ul style="list-style-type: none"> <li>• Check whether you select right function. Press <b>FUNCTION</b> on the remote control or <b>F</b> on the unit. And check the selected function.</li> <li>• Speaker cables are not connect correctly. Connect the speaker cables correctly.</li> <li>• The volume is set to minimum. Use the volume knob or <b>VOLUME +/—</b> to adjust the volume.</li> </ul>
The unit does not start playback.	<ul style="list-style-type: none"> <li>• An unplayable disc is inserted. Insert a playable disc.</li> <li>• No disc is inserted. Insert a disc.</li> <li>• The disc is dirty. Clean the disc. (Refer to page 25)</li> <li>• The disc is inserted upside down. Place the disc with the label or printed side facing upwards.</li> </ul>
Radio stations cannot be tuned in properly.	<ul style="list-style-type: none"> <li>• The antenna is positioned poorly. Adjust its position.</li> <li>• The signal strength of the radio station is too weak. Tune to the station manually.</li> <li>• No stations have been preset or preset stations have been cleared (when tuning by scanning preset channels). Preset some radio stations, see page 16 for details.</li> </ul>
The remote control does not work properly.	<ul style="list-style-type: none"> <li>• The remote control is not pointed at the remote sensor of the unit. Point the remote control at the remote sensor of the unit.</li> <li>• The remote control is too far from the unit. Operate the remote control within about 16 ft (5 m).</li> <li>• There is an obstacle in the path of the remote control and the unit. Remove the obstacle.</li> <li>• The battery in the remote control is exhausted. Replace the battery with new one.</li> </ul>
Android device does not work.	<ul style="list-style-type: none"> <li>• Check whether your device's O/S is ver 4.1(or later) or AOA 2.0(or later).</li> <li>• Connect your Android device using USB cable firmly.</li> </ul>
Clock does not displayed.	<ul style="list-style-type: none"> <li>• Connect your Bluetooth device to your unit through BT app.</li> </ul>

## Specifications

General	
Power supply	Refer to the main label.
Power consumption	Refer to the main label.
Net Weight	2.2 kg
External dimensions (W x H x D)	(229 x 130 x 236) mm
Operating conditions Temperature	5 °C to 35 °C (41 °F to 95 °F)
Operating humidity	5 % to 85 %

Inputs	
PORT. IN	0.7 Vrms (3.5 mm stereo jack)

Tuner	
FM Tuning Range	87.5 MHz to 108.0 MHz or 87.50 MHz to 108.00 MHz

Amplifier	
Output Power	50W + 50 W
T.H.D	10 %

CD	
Frequency Response	40 Hz to 20 kHz
Signal-to-noise ratio	70 dB
Dynamic range	55 dB

USB	
USB Version	USB 2.0 or USB 1.1
Bus Power Supply	5 V  500 mA

Speakers	
Type	2 Way 2 Speaker
Impedance	6 Ω
Rated Input Power	50 W
Max. Input Power	100 W
Net Dimensions (WxHxD)	(150 x 251 x 150) mm
Net Weight(1EA)	1.8 kg

- Design and specifications are subject to change without notice.



## Maintenance

### Handling the Unit

#### When shipping the unit

Please save the original shipping carton and packing materials. If you need to ship the unit, for maximum protection, re-pack the unit as it was originally packed at the factory.

#### Keeping the exterior surfaces clean

Do not use volatile liquids such as insecticide spray near the unit.

Wiping with strong pressure may damage the surface.

Do not leave rubber or plastic products in contact with the unit for a long period of time.

#### Cleaning the unit

To clean the player, use a soft, dry cloth. If the surfaces are extremely dirty, use a soft cloth lightly moistened with a mild detergent solution. Do not use strong solvents such as alcohol, benzine, or thinner, as these might damage the surface of the unit.

#### Maintaining the Unit

The unit is a high-tech, precision device. If the optical pick-up lens and disc drive parts are dirty or worn, the picture quality could be diminished. For details, please contact your nearest authorized service centre.

## Notes on Discs

### Handling Discs

Never stick paper or tape on the disc.

### Storing Discs

After playing, store the disc in its case. Do not expose the disc to direct sunlight or sources of heat and never leave it in a parked car exposed to direct sunlight.

### Cleaning Discs

Do not use strong solvents such as alcohol, benzene, thinner, commercially available cleaners, or anti-static spray intended for old vinyl records.

## Trademarks and Licenses



*Bluetooth*® wireless technology is a system which allows radio contact between electronic devices.

Connecting individual devices under *Bluetooth*® wireless technology does not incur any charges. A mobile phone with *Bluetooth*® wireless technology can be operated via the Cascade if the connection was made via *Bluetooth*® wireless technology.

The *Bluetooth*® word mark and logos are owned by the *Bluetooth*® SIG, Inc. and any use of such marks by LG Electronics is under license.

Other trademarks and trade names are those of their respective owners.

	Телефон	Режим работы	Интернет
Россия	8-800-200-7676	Круглосуточно	<a href="http://www.lg.com">http://www.lg.com</a>
Беларусь	8-820-0071-1111		
Латвия	8-0200-201	9:00 - 17:00 (Пн.-Пт.)	
Литва	8-800-08-081		
Эстония	800-9990	8:00 - 21:00 (Пон.-Пят.) 8:30 - 18:30 (Суб., Нд.)	
Україна	0-800-303-000		
Казахстан	8-8000-805-805	9:00-20:00 (Пн.-Пят.) 9:00-18:00 (Суб., Вс.)	
	2255 (GSM)		
Узбекистан	8 800 120 2222	9:00 - 18:30 (Пн.- Пят.) 9:00 - 15:00 (Суб., Вс.)	
Кыргызстан	800 0071 0005	Круглосуточно	
Молдова	00-800-0071-0005 (Только для стационарных телефонов)	Круглосуточно	



Символ «не для пищевой продукции» применяется в соответствии с техническим регламентом Таможенного союза «О безопасности упаковки» 005/2011 и указывает на то, что упаковка данного продукта не предназначена для повторного использования и подлежит утилизации. Упаковку данного продукта запрещается использовать для хранения пищевой продукции.

Символ Кендік одақтың 005/2011 техникалық регламентіне сәйкес қолданылады және осы өнімнің қаптамасын екінші рет пайдалануға арналмағанын және жоюға жататынын көрсетеді. Осы өнімнің қаптамасын азық-түлік өнімдерін сақтау үшін пайдалануға тыйым салынады.



Символ «петля Мебиуса» указывает на возможность утилизации упаковки. Символ может быть дополнен обозначением материала упаковки в виде цифрового и/или буквенного обозначения.

Символ қаптаманы жою мүмкіндігін көрсетеді. Символ сандық код және/немесе әріп белгілері түріндегі қаптама материалының белгісімен толықтырылуы мүмкін.

### Российская Федерация

Импортер ООО «ЛГ Электроник Рус»

Адрес импортера: 143160 Российская Федерация, Московская область, Рузский район, сельское поселение Дороховское, 86 км. Минского шоссе, д.9

Адрес производителя : MATESTAR

Дон Гуан MATESTAR ЭЛЕКТРОНИК ЛТД. Китай, г. ДонгГуан, округ Чанг Пин, район Чен Ву Бей

Сделано в Китае

### Україна

Найменування та адреса імпортера

ПІІ 'ЛГ Електронікс Україна', Україна, 01004, м. Київ, вул. Басейна, 4 (літера А), тел.: +38 (044) 201-43-50, факс: +38 (044) 201-43-73

### Қазақстан Республикасы

Импорттаушы АҚ «ЭЛ Джи Электроник Алматы Қазақстан», 050061, Алматы қ., к. Көкөрай, 2А

Өндірушінің мекенжайы: MATESTAR

Dong Guan MATESTAR ELECTRONICS LTD. Қытай, ДонгГуан қ., ЧангПинг қаласы, ЧенВубей ауданы.

Қазақстан Республикасы территориясында тұтынушылардан келіп түскен талаптар мен ұсыныстарды қарайтын және тауарды жөндеу мен техникалық қызмет көрсететін ұжым:

АҚ «Эл Джи Электроник Алматы Қазақстан», 050061, Қазақстан Республикасы, Алматы қ., Көкөрай, 2А. Басқа сервис орталықтары жайында мағлұматты «Тұтынушыға қызмет көрсету орталығына» телефон шалу арқылы білуге болады.

Қытайда жасалған