

OWNER'S MANUAL

Mini Hi-Fi System

Please read this manual carefully before operating your set and retain it for future reference.

CM4740 (CM4740, CMS4740F, CMS4740W)

CM4640 (CM4640, CMS4740F)

CM4540 (CM4540, CMS4540F, CMS4540W)

CM4440 (CM4440, CMS4540F)

CM4340 (CM4340, CMS4340F)



MFL86006594

www.lg.com

Safety Information



CAUTION: TO REDUCE THE RISK OF ELECTRIC SHOCK DO NOT REMOVE COVER (OR BACK) NO USER-SERVICEABLE PARTS INSIDE REFER SERVICING TO QUALIFIED SERVICE PERSONNEL.



This lightning flash with arrowhead symbol within an equilateral triangle is intended to alert the user to the presence of uninsulated dangerous voltage within the product's enclosure that may be of sufficient magnitude to constitute a risk of electric shock to persons.



The exclamation point within an equilateral triangle is intended to alert the user to the presence of important operating and maintenance (servicing) instructions in the literature accompanying the product.

WARNING: TO PREVENT FIRE OR ELECTRIC SHOCK HAZARD, DO NOT EXPOSE THIS PRODUCT TO RAIN OR MOISTURE.

WARNING: Do not install this equipment in a confined space such as a book case or similar unit.

CAUTION: Do not block any ventilation openings. Install in accordance with the manufacturer's instructions.

Slots and openings in the cabinet are provided for ventilation and to ensure reliable operation of the product and to protect it from over heating. The openings shall be never be blocked by placing the product on a bed, sofa, rug or other similar surface. This product shall not be placed in a built-in installation such as a bookcase or rack unless proper ventilation is provided or the manufacturer's instruction has been adhered to.

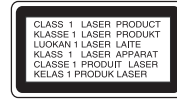

CAUTION: This product employs a Laser System. To ensure proper use of this product, please read this owner's manual carefully and retain it for future reference. Shall the unit require maintenance, contact an authorized service center. Use of controls, adjustments or the performance of procedures other than those specified herein may result in hazardous radiation exposure. To prevent direct exposure to laser beam, do not try to open the enclosure.

CAUTION concerning the Power cord

Most appliances recommend they be placed upon a dedicated circuit;

That is, a single outlet circuit which powers only that appliance and has no additional outlets or branch circuits. Check the specification page of this owner's manual to be certain. Do not overload wall outlets. Overloaded wall outlets, loose or damaged wall outlets, extension cords, frayed power cords, or damaged or cracked wire insulation are dangerous. Any of these conditions could result in electric shock or fire. Periodically examine the cord of your appliance, and if its appearance indicates damage or deterioration, unplug it, discontinue use of the appliance, and have the cord replaced with an exact replacement part by an authorized service center. Protect the power cord from physical or mechanical abuse, such as being twisted, kinked, pinched, closed in a door, or walked upon. Pay particular attention to plugs, wall outlets, and the point where the cord exits the appliance. To disconnect power from the mains, pull out the mains cord plug. When installing the product, ensure that the plug is easily accessible.

This device is equipped with a portable battery or accumulator.

Safety way to remove the battery or the battery from the equipment: Remove the old battery or battery pack, follow the steps in reverse order than the assembly. To prevent contamination of the environment and bring on possible threat to human and animal health, the old battery or the battery put it in the appropriate container at designated collection points. Do not dispose of batteries or battery together with other waste. It is recommended that you use local, free reimbursement systems batteries and accumulators. The battery shall not be exposed to excessive heat such as sunshine, fire or the like.

CAUTION: The apparatus shall not be exposed to water (dripping or splashing) and no objects filled with liquids, such as vases, shall be placed on the apparatus.

Table of Contents

1 Getting Started

- 2 Safety Information
- 6 Unique Features
- 6 Accesories
- 7 Playable file Requirement
 - 7 – Music file requirement
 - 7 – Compatible USB Devices
 - 7 – USB device requirement
- 8 Remote Control
- 9 Front Panel
- 11 Rear Panel (CM4740, CM4540)
- 12 Rear Panel (CM4640)
- 13 Rear Panel (CM4440)

2 Connecting

- 14 Connecting to speakers
 - 14 – Attaching the speakers to the unit
 - 14 – Attaching the subwoofer to the unit. (CM4740, CM4540)
- 15 Antenna Connection
- 15 Optional Equipment Connection
 - 15 – USB Connection
 - 16 – AUX IN Connection
 - 16 – PORT. IN Connection

3 Operating

- 17 Basic Operations
 - 17 – CD/USB Operations
 - 17 – Auto Play
- 18 Other Operations
 - 18 – Programmed Playback
 - 18 – Deleting Programmed list
 - 18 – Displaying file information
 - 18 – Searching for a folder
 - 18 – Deleting an MP3/WMA file
 - 19 – Turn off the sound temporarily
 - 19 – DEMO
 - 19 – AUTO DJ playback
- 20 Radio Operations
 - 20 – Listening to the radio
 - 20 – Presetting the Radio Stations
 - 20 – Deleting all the saved stations
 - 20 – Improving poor FM reception
- 21 Sound adjustment
 - 21 – Setting the surround mode
- 22 Setting the Clock
 - 22 – Setting the Clock through “LG Bluetooth Remote” App
 - 22 – Using your player as an alarm clock
 - 22 – Sleep Timer Setting
 - 22 – Dimmer
- 22 Auto power down
- 23 Advanced Operations
 - 23 – Listening to the sound from your external device
 - 23 – Recording to USB
 - 23 – To select recording bit rate and speed
 - 23 – Dubbing USB to USB
- 24 Using a Bluetooth wireless technology
 - 25 – Listening to music stored on the Bluetooth devices
 - 26 – Using Bluetooth App

4 Troubleshooting

28 Troubleshooting

5 Appendix

29 Specifications

30 Speaker specifications

31 Maintenance

31 – Handling the Unit

31 – Notes on Discs

31 Trademarks and Licenses

1

2

3

4

5

Unique Features

USB Direct Recording

Records music to your USB device.

AUTO DJ

Blends the end of one song into the beginning of another for seamless playback.

Bluetooth

Listens to music stored on your Bluetooth device.

LG Bluetooth Remote

You can control this unit with your Android device via Bluetooth. This unit and your device must be paired for Bluetooth. Visit "Google Android Market (Google Play Store)" or use the QR code shown below to search for "LG Bluetooth Remote" app. For detailed information, refer to page 26-27.



(Android OS)

Accessories

Please check and identify the supplied accessories.

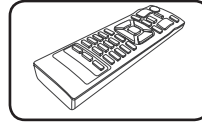

Remote Control (1)

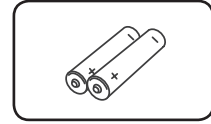

Batteries (2)

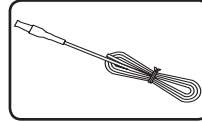

FM Antenna (1)

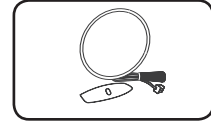

AM Antenna (1)

Playable file Requirement

Music file requirement

MP3/WMA file compatibility with this unit is limited as follows.

- Sampling frequency : within 32 to 48 kHz (MP3), within 32 to 48 kHz (WMA)
- Bit rate : within 32 to 320 kbps (MP3), 40 to 192 kbps (WMA)
- Maximum files : Under 999
- File extensions : “.mp3”/“.wma”
- CD-ROM file format : ISO 9660/JOLIET
- We recommend that you use Easy-CD Creator, which creates an ISO 9660 file system.
- You have to set the disc format option to [Mastered] in order to make the discs compatible with the LG players when formatting rewritable discs. When setting the option to Live File System, you cannot use it on LG players. (Mastered/Live File System : Disc format system for Windows Vista)

The DTS is not supported. In case of DTS audio format, audio is not output.

Compatible USB Devices

- MP3 Player : Flash type MP3 player.
- USB Flash Drive :
Devices that support USB2.0 or USB1.1.
- The USB function of this unit does not support all USB devices.

USB device requirement

- Devices which require additional program installation when you have connected it to a computer, are not supported.
- Do not extract the USB device while in operation.
- For a large capacity USB, it may take longer than a few minute to be searched.
- To prevent data loss, back up all data.
- If you use a USB extension cable or USB hub, the USB device is not recognized.
- Using NTFS file system is not supported. (Only FAT(16/32) file system is supported.)
- This unit is not supported when the total number of files is 1,000 or more.
- External HDD, Card readers, Locked devices, or hard type USB devices are not supported.
- USB port of the unit cannot be connected to PC. The unit cannot be used as a storage device.
- Some USB may not work with this unit.

Remote Control

1
Getting Started

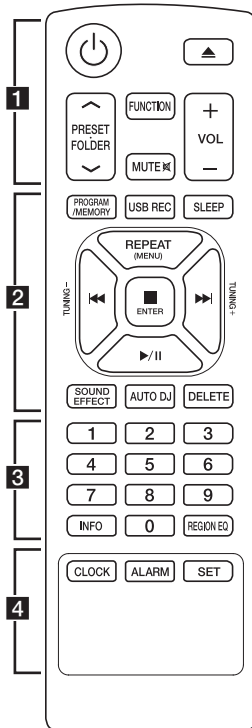

Battery Installation

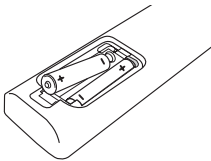

Remove the battery cover on the rear of the Remote Control, and insert two (size AAA) batteries with **+** and **-** matched correctly.

• • • • • **1** • • • • •

⏻ (Power) : Switches the unit ON or OFF.

▲ (Open/Close) : Opens and closes the disc tray.

PRESET-FOLDER **▲/▼** :

- Searches for a folder of MP3/WMA files. When a CD/USB containing MP3/WMA files in several folders is being played, press **PRESET-FOLDER ▲/▼** to select the folder you want to play.

- Chooses a preset number for a radio station.

FUNCTION : Selects the function and input source.

MUTE **⏻** : Mutes the sound.

VOL +/- : Adjusts speaker volume.

• • • • • **2** • • • • •

PROGRAM/MEMORY :

- Stores radio stations.
- Creates a playlist you want to listen to.

USB REC : USB direct recording.

SLEEP : Sets the system to turn off automatically at a specified time. (Dimmer : The display window will be darkened by half.)

REPEAT(MENU) : Listens to your tracks/files repeatedly or randomly.

⏮/⏭ (Skip/Search) :

- Skips Fast backward or Forward.
- Searches for a section within a track/file.

TUNING-/+ : Selects the radio station.

■ ENTER :

- Stops playback or recording.
- Cancels DELETE function.

▶/⏸ (Play/Pause) :

- Starts or pauses playback.
- Selects STEREO/MONO.

SOUND EFFECT : Chooses sound impressions.

AUTO DJ : Selects the AUTO DJ mode. (For more information refer to page 19)

DELETE : Deletes MP3/WMA files.

• • • • • **3** • • • • •

0 to 9 numerical buttons : Selects numbered tracks/files, or preset number.

INFO : Sees informations about your music. An MP3 file often come with ID3 tag. The tag gives the Title, Artist, Album or Time information.

REGION EQ : Chooses Local Specialization equalizer.

• • • • • **4** • • • • •

CLOCK : Sets a clock and checks a time.

ALARM : Uses your player as an alarm clock.

SET : Confirms the setting.

Front Panel

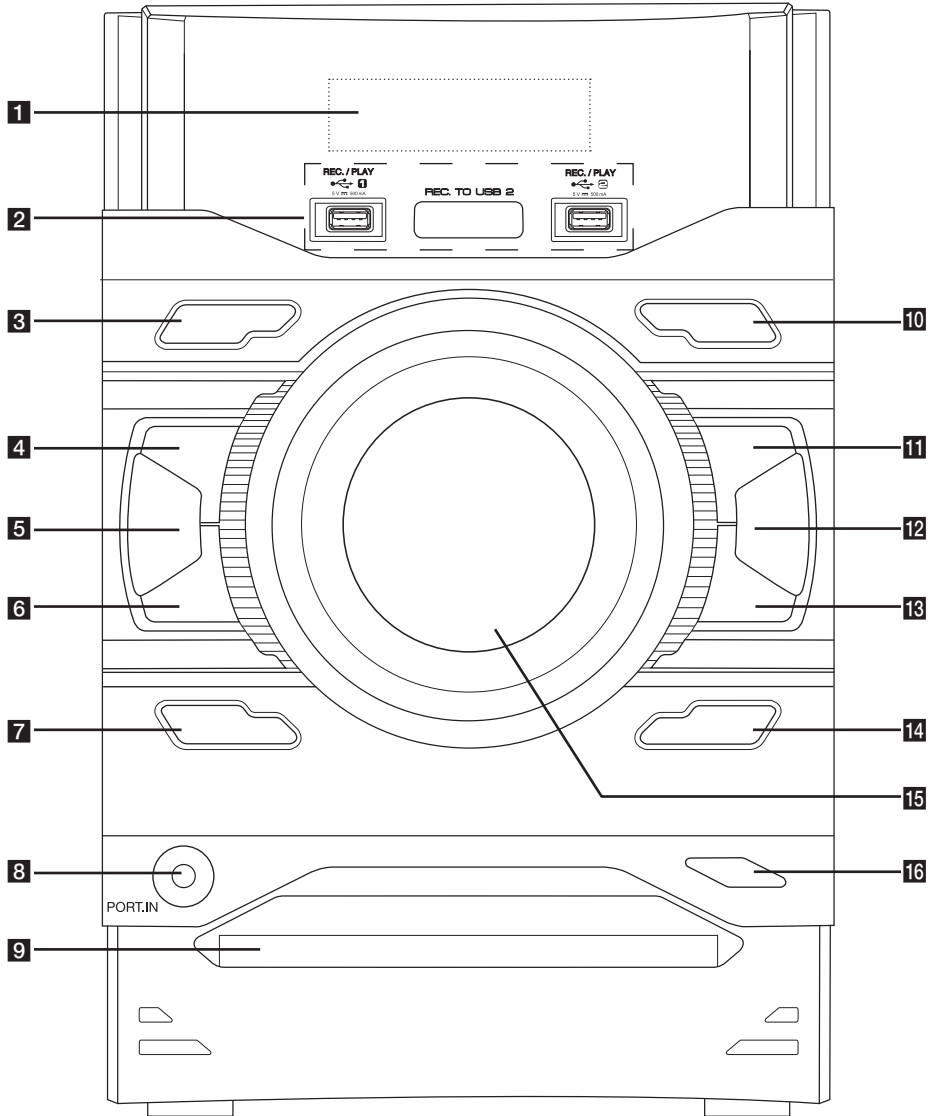

- 1** Display window
- 2** USB 1/ USB 2
Plays the audio files by connecting the USB device.
- R** **USB REC.**
Records to USB.
- 3** **⏻/⏻** (Power)
Switches the unit ON or OFF.
- 4** **⏹** (Stop)
Stops playback or recording.
- 5** **AUTO DJ**
Selects the AUTO DJ mode.
(For more informaion refer to page 19)
- 6** **⏮** (Skip/Search)
- Searches backward.
- Skips to the previous track/file.
- 7** **DEMO**
Demonstrates each of functions.
- 8** **PORT. IN**
- 9** Disc tray

- 10** **FUNCTION**
Selects the function or input source.
- 11** **>||**
ST./MO.
- Starts or pauses playback.
- Selects Stereo/Mono.
- 12** **LATIN EQ**
Chooses Local Specialization equalizer.
- 13** **>>|** (Skip/Search)
- Searches forward.
- Skips to the next track/file.
- 14** **BASS BLAST**
Selects the BASS BLAST or BYPASS sound directly.
- 15** Master Volume
Adjusts volume of speaker.
- 16** **△** (Open/Close)
Opens or closes the disc tray.

Rear Panel (CM4740, CM4540)

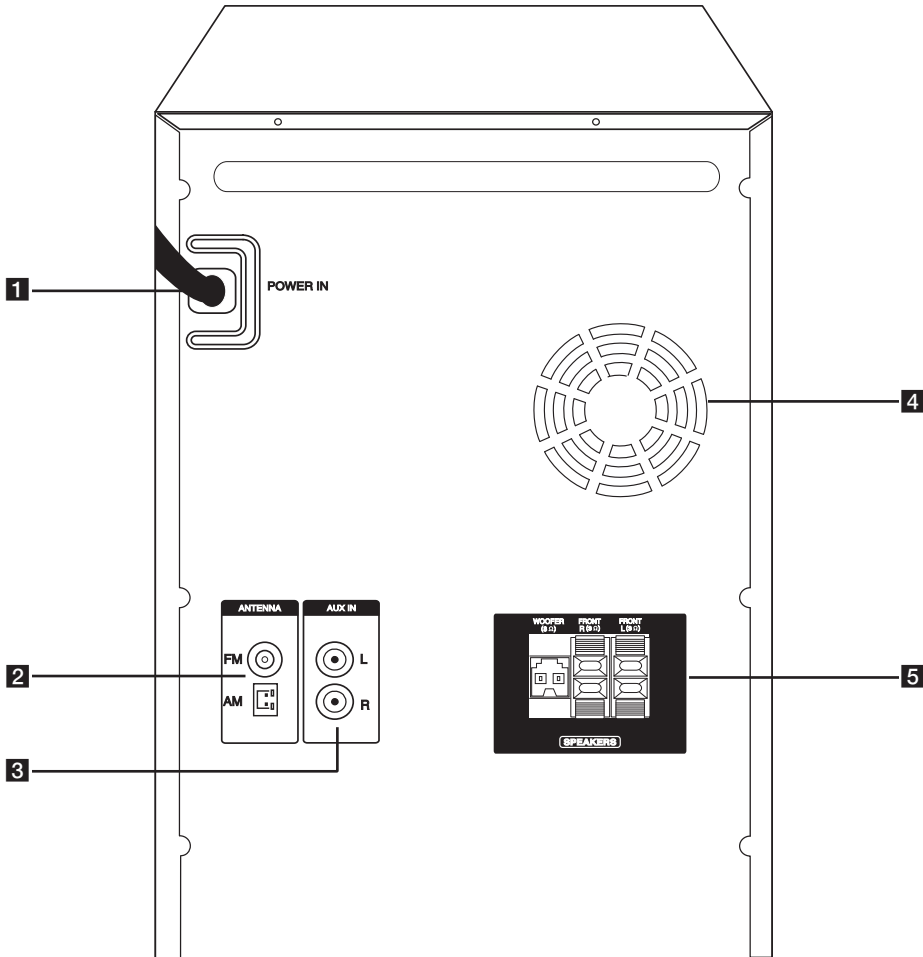

- 1** POWER IN
- 2** ANTENNA (FM/AM)
- 3** AUX IN (L/R) connectors
- 4** Cooling fan
- 5** SPEAKERS terminal/cord

1

Getting Started

1

Getting Started

Rear Panel (CM4640)

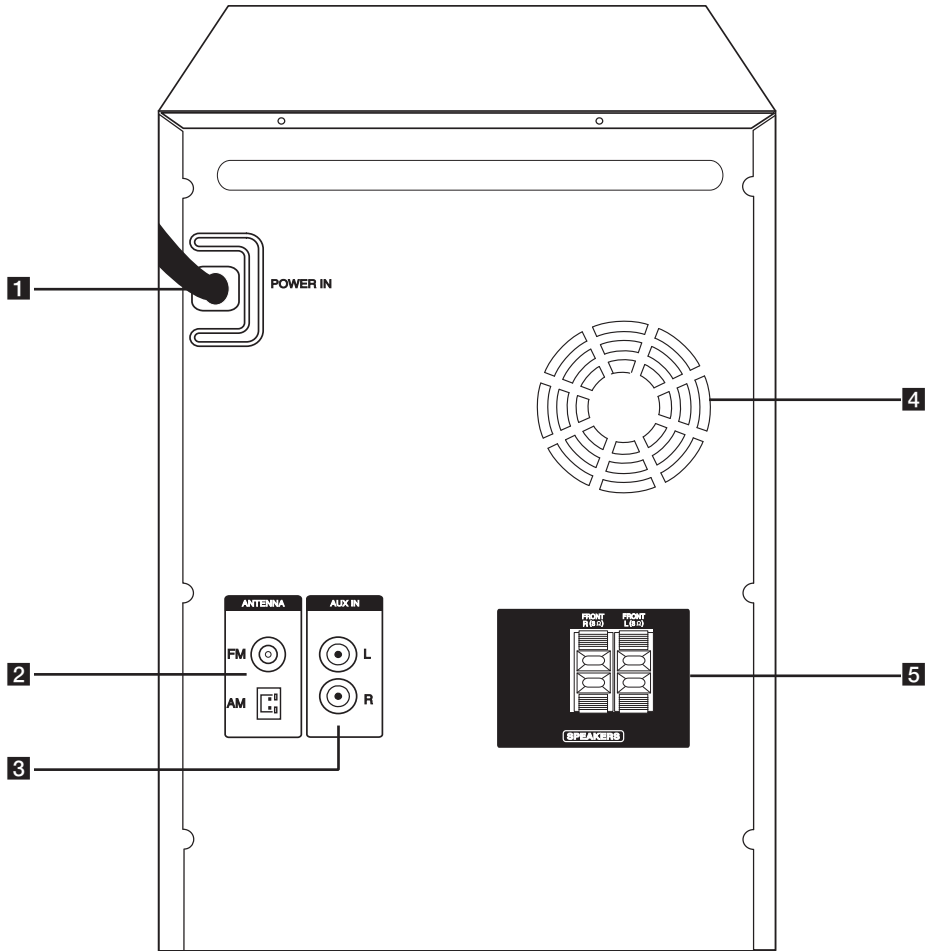

- 1** POWER IN
- 2** ANTENNA (FM/AM)
- 3** AUX IN (L/R) connectors
- 4** Cooling fan
- 5** SPEAKERS terminal

Rear Panel (CM4440, CM4340)

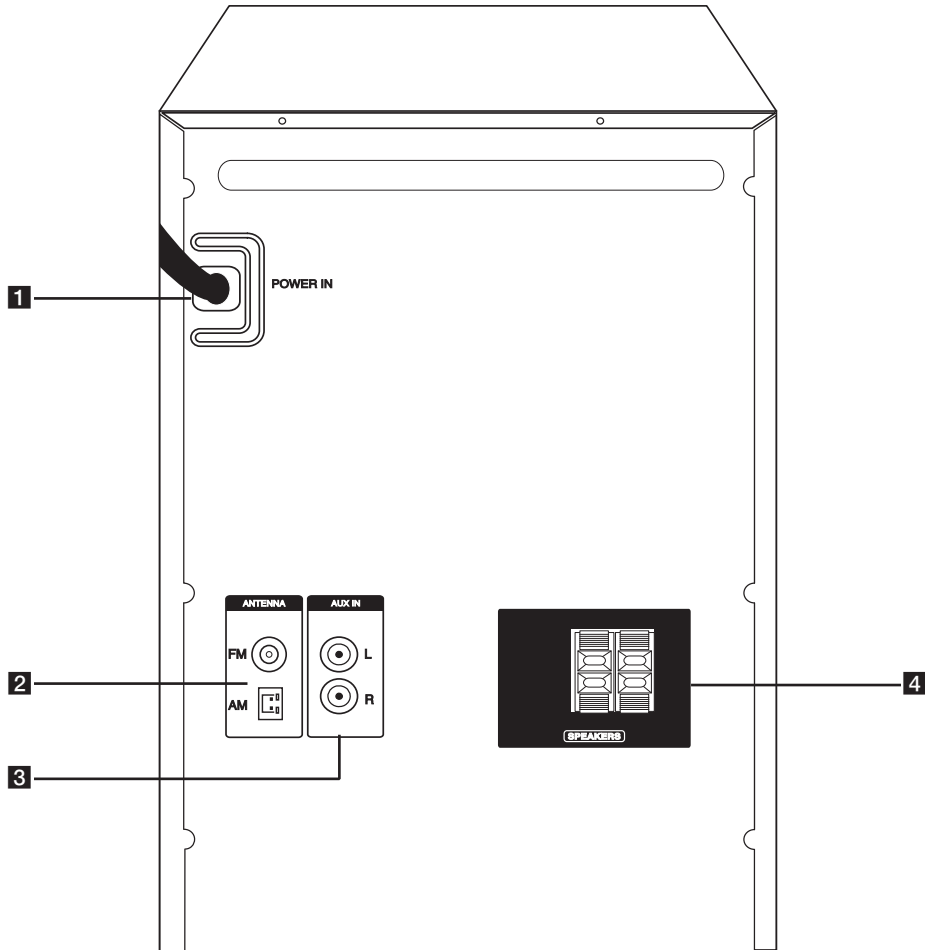

- 1** POWER IN
- 2** ANTENNA (FM/AM)
- 3** AUX IN (L/R) connectors
- 4** SPEAKERS terminal

1

Getting Started

Connecting to speakers

2

Connecting

Attaching the speakers to the unit

To connect the cable to the unit, press each plastic finger pad to open the connection terminals on the unit. Insert the wire and release the finger pad.

Connect the black stripe of each wire to the terminals marked - (minus) and the other end to the terminals marked + (plus).

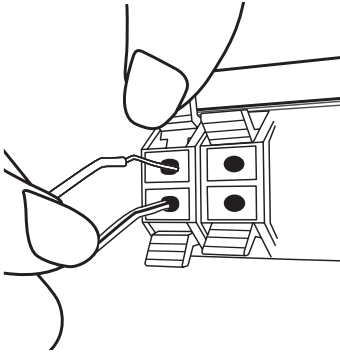

Attaching the subwoofer to the unit. (CM4740, CM4540)

Connect a woofer cord to the player.

When connecting a woofer cord to the player, insert the connector until it clicks.

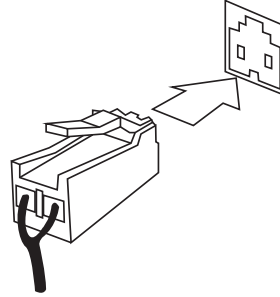

Color	Speaker
Orange	Sub woofer
Red	Front R
White	Front L

⚠ Caution

- Be careful to make sure children do not put their hands or any objects into the *speaker duct.
*Speaker duct: A hall for plentiful bass sound on speaker cabinet (enclosure)
- The speakers contain magnet parts, so color irregularity may occur on the TV screen or PC monitor screen. Please use the speakers far away from either TV screen or PC monitor.
- Do not connect any other speaker except sub woofer speaker to the sub woofer connection terminal on the rear of the unit.

Antenna Connection

Connect the supplied FM/AM antenna for listening to the radio.

Connect the antenna to the antenna port on the back of the unit. Be sure to extend the FM wire antenna fully.

Connect the AM loop antenna to the AM antenna connector.

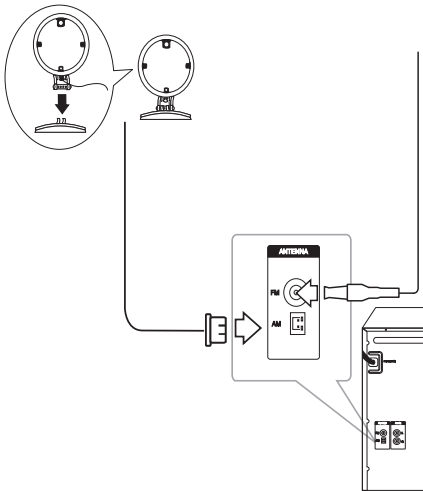

! Note

To prevent noise pickup, keep the AM Loop antenna away from the unit and other components.

Optional Equipment Connection

USB Connection

Connect the USB device (or MP3 player, etc.) to the USB port on the unit.

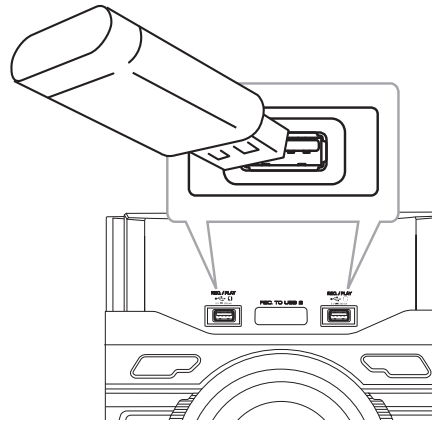

! Note

Removing the USB Device from the unit.

1. Choose a different function/mode or press **ENTER** on the remote control or **ENTER** on the unit twice in a row.
2. Remove the USB device from the unit.

AUX IN Connection

Connect an output of auxiliary device(Camcorder, TV, Player, etc) to the **AUX IN(L/R)** connector.

If your device has only one output for audio(mono), connect it to the left (white) audio jack on the unit.



Connecting

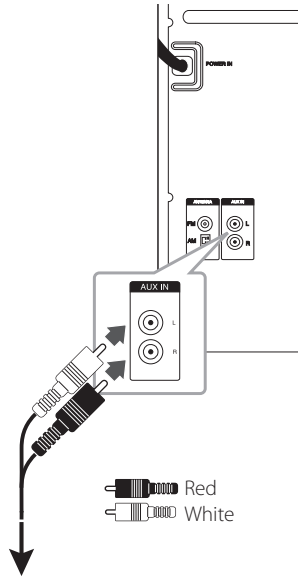

To the audio output jacks
of your component
(Camcorder, TV, Player, etc)

PORT. IN Connection

Connect an output (earphone or line out) of portable device (MP3 or PMP etc) to the **PORT. IN** connector.

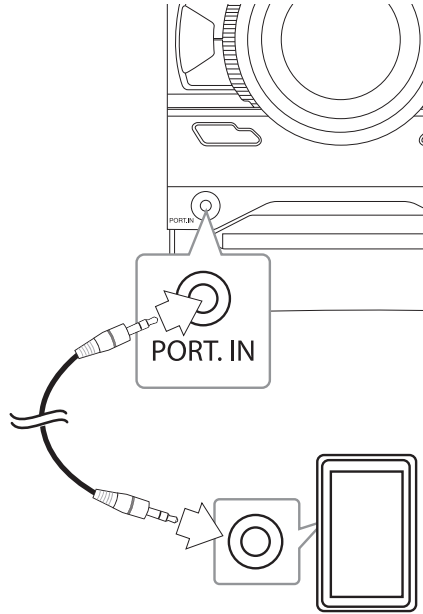

Basic Operations

CD/USB Operations

1. Insert the disc by pressing **▲** on the remote control or **△** on the unit.
Connect the USB device to the USB 1/2 port.
2. Select the CD or USB function by pressing **FUNCTION**.
3. Select a track/file you want to play by pressing **◀◀/▶▶** on the remote control or **◀◀/▶▶** on the unit.

To	Do this
Stop	Press ■ENTER on the remote control or □ on the unit..
Playback	Press ▶/ on the remote control or > on the unit.
Pause	During playback, press ▶/ on the remote control or > on the unit.
Skipping to the next/previous track/file	Press ◀◀/▶▶ on the remote control or ◀◀/▶▶ on the unit to skip the track/file in stop status. During playback, press ▶▶ on the remote control or >> on the unit to go to the next track/file. Playing less than 2 seconds, press ◀◀ on the remote control or ◀◀ on the unit to go to the previous track/file. Playing after 3 seconds, press ◀◀ on the remote control or ◀◀ on the unit to go to the beginning of the track/file..
Selecting a track/file directly	Press 0 to 9 numerical buttons on the remote control to go to the desired file or track directly.
Searching for a section within a track/file	Press and hold ◀◀/▶▶ on the remote control or ◀◀/▶▶ on the unit during playback and release it at the point you want to listen to.
Playing repeatedly or randomly	Press REPEAT(MENU) on the remote control repeatedly. Refer to the note for details about the display change.

Note

- The display changes in the following order.

USB	MP3/WMA/CD	AUDIO CD
RPT 1	RPT 1	RPT 1
RPT*DIR	RPT DIR	-
RPT ALL	RPT ALL	RPT ALL
RANDOM	RANDOM	RANDOM
OFF	OFF	OFF

*DIR : Directory

- When you play Program List, only RPT 1 and RPT ALL are available.
- Even after restarting the unit or switching one function to another, you can listen to music from the point where it's last been played.
- If you leave the disc tray open for 5minutes, it will close automatically.

Auto Play

AUDIO/MP3/WMA CD is played automatically after tray is open & closed.

Automatically switches to the CD function if tray is open & closed when there is no disc in tray.

Other Operations

Programmed Playback

The program function enables you to store your favorite files from any disc or USB device.

A program can contain 20 tracks/files for each media (CD, USB1,USB2). Possible to save a total of 60 tracks/files.

1. Press **PROGRAM/MEMORY** on the remote control in stop status.
2. Press **◀/▶** on the remote control to select a track/file.
3. Press **PROGRAM/MEMORY** to save and select a next track/file.
4. Repeat steps 2-3 to store other tracks/files. (You can modify the list by pressing **PRESET-FOLDER ▲/▼** to select the program number.)
5. Press **PROGRAM/MEMORY** once again.

To play the programmed list, press **▶/||** after you make the list.

! Nota

When making or modifying the programmed list, REPEAT mode is off.

Deleting Programmed list

Deleting function is worked only on the edit mode.

1. Press **PROGRAM/MEMORY** on the remote control in stop status.
2. Select a song by pressing **PROGRAM/MEMORY** or **PRESET-FOLDER ▲/▼** repeatedly.
3. Press **DELETE** while a song is selected.

! Note

- Programmed list is cleared in the case below.
 - Removing the disc or the USB device.
 - Deleting or recording music files in the USB device.
- Program is switched off in the case below.
 - Changing the function to the others.
 - Turning off and on the unit.
 - Operating the numeric buttons on the remote control.

Displaying file information

While playing an MP3 file containing file information, you can display the information by pressing **INFO**.

Searching for a folder

1. Press **PRESET-FOLDER ▲/▼** on the remote control repeatedly until a desired folder appears in the display window.
2. Press **▶/||** to play it. The first file of the folder will be played.

Deleting an MP3/WMA file

You can delete a file, folder or format by pressing **DELETE**. (USB only)

1. Press **DELETE** repeatedly while selecting the MP3/WMA file. This function is supported only in stop status. The display changes in the following order.
 - DEL FILE : Deletes file.
 - DEL DIR : Deletes folder.
 - FORMAT : Formats USB.
2. To delete file/folder or format, press **▶/||** on the remote control or **>||** on the unit.
3. If you want to exit the current mode, press **■ ENTER** on the remote control or press **□** on the unit.

! Caution

- Do not extract the USB device during operation.(play, delete, etc.)
- Regular back up is recommended to prevent data loss.
- The delete function may not be supported according to the USB status.

Turn off the sound temporarily

Press **MUTE**  on the remote control to mute your sound.

You can mute your unit, for example, to answer the telephone, the "MUTE" will appear in the display window.

To cancel it, press **MUTE**  again or change the volume level.

DEMO

In power off state, press **DEMO** on the unit once. The unit will power on and display the each of functions in the display window. To cancel the DEMO function, press **DEMO** once more.

Note

You can enjoy other functions during the DEMO. Then the DEMO will pause to temporary.
 - Without input key in 10 sec, the DEMO will play back automatically.



AUTO DJ playback

Auto DJ blends the end of one song into the beginning of another for seamless playback. It equalizes volume across tracks for uninterrupted playback.

Press **AUTO DJ** on the remote control or unit repeatedly, the display changes as follows.
 RANDOM (AUTO DJ RANDOM) -> RPT (AUTO DJ SEQUENTIAL) -> (AUTO DJ OFF)

Mode	Display Window	Description
OFF	- (AUTO DJ OFF)	-
RANDOM	RANDOM (AUTO DJ RANDOM)	The music is played randomly on this mode.
REPEAT	RPT (AUTO DJ SEQUENTIAL)	The music is played repeatedly on this mode.

Note

- Searching for a section within a track/file or playing repeatedly or randomly is not supported on the AUTO DJ mode.
- During AUTO DJ mode, it is not available to search file by pressing **PRESET-FOLDER**   on the remote control.
- If you move to other functions or stop the music using  on the unit (or **ENTER** on the remote control) on AUTO DJ mode, AUTO DJ will be disable.
- AUTO DJ is not supported in the music file whose length is less than 60 seconds.
- During recording, AUTO DJ is not available.
- Only AUTO DJ SEQUENTIAL is selected when played Program list.

Radio Operations

Be sure that FM/AM antenna is connected.
(Refer to page 15)

Listening to the radio

1. Press **FUNCTION** until FM or AM appears in the display window.
The last received station is tuned in.

2. Auto tuning : Press **TUNING -/+** on the remote control or **|<< / >>|** on the unit for about 2 seconds until the frequency indication starts changing, then release. scanning stops when the unit tunes in a station.

Manual tuning: Press **TUNING -/+** on the remote control or **|<< / >>|** on the unit repeatedly.

3. Adjust the volume by pressing **VOL +/-** on the remote control or by rotating volume knob on the unit repeatedly.

Presetting the Radio Stations

You can preset 50 stations for FM and AM.
Before tuning, make sure to turn down the volume.

1. Press **FUNCTION** until FM/AM appears in the display window.
2. Select the desired frequency by pressing **TUNING -/+** on the remote control or **|<< / >>|** on the unit.
3. Press **PROGRAM/MEMORY**. A preset number will blink in the display window.
4. Press **PRESET-FOLDER ^/V** to select the preset number you want.
5. Press **PROGRAM/MEMORY** on the remote control. The station is stored.
6. Repeat steps 2 to 5 to store other stations.
7. To listen to a preset station, press **PRESET-FOLDER ^/V** or **0** to **9** numerical buttons.

Deleting all the saved stations

1. Press and hold **PROGRAM/MEMORY** for two seconds. "ERASEALL" will blink in the unit display.
2. Press **PROGRAM/MEMORY** to erase all saved radio stations.

Improving poor FM reception

Press **▶/||** on the remote control or **>||** on the unit. This will change the tuner from stereo to mono. Then the reception will be better than before.

Sound adjustment

Setting the surround mode

This system has a number of pre-set surround sound fields. You can select a desired sound mode by using **SOUND EFFECT** on the remote control.

The displayed items for the Equalizer may be different depending on sound sources and effects.

On Display	Description
NATURAL	You can enjoy comfortable and natural sound.
Local Specialization equalizer	Regionally optimized sound effect. (FORRO/FUNK/ SERTANEJO/DANGDUT/ARABIC/ PERSIAN/INDIA/REGUETON/ MERENGUE/SALSA/SAMBA/ CUMBIA/AFRO)
AUTO EQ	Realizes the sound equalizer that is the most similar to the genre of which is included in the MP3 ID3 tag of song files.
POP CLASSIC JAZZ ROCK	This program lends an enthusiastic atmosphere to the sound, giving you the feeling you are at an actual rock pop, jazz or classic concert.
MP3 -- OPT	This function is optimized for compressible MP3 file. It improves the treble sound.
BASS	Reinforces the treble, bass and surround sound effect.
LOUDNESS	Improves the bass and treble sound.
FOOT BALL	You can enjoy the sound effect FOOTBALL STADIUM.
BYPASS	You can enjoy the sound without equalizer effect.

! Note

- On some speakers, sound may not be heard or heard in low sound depending on the sound mode.
- Maybe you need to reset the surround mode, after switching the input, sometimes even after the sound track changed.
- By pressing **BASS BLAST** on the unit you can directly select the BYPASS or BASS BLAST sound.
- By pressing **LATIN EQ** on the unit, you can directly select various latin equalizers.

Setting the Clock

1. Turn the unit on.
2. Press and hold **CLOCK**.
3. Select time mode by pressing **◀◀/▶▶** on the remote control.
 - AM 12:00 (for an AM and PM display) or 0:00 (for a 24 hour display)
4. Press **SET** to confirm your selection.
5. Select the hours by pressing **◀◀/▶▶** on the remote control.
6. Press **SET**.
7. Select the minutes by pressing **◀◀/▶▶** on the remote control.
8. Press **SET**.

Setting the Clock through "LG Bluetooth Remote" App

Install "LG Bluetooth Remote" app on your Android device. (see page 26-27)

Your unit's clock will be automatically synchronized with your device by activating Bluetooth connection through "LG Bluetooth Remote" app.

Using your player as an alarm clock

1. Turn the unit on.
2. Press and hold **ALARM**.
3. Press **◀◀/▶▶** on the remote control to change the hours and minutes and press **SET** to save.
4. Press **◀◀/▶▶** on the remote control to select function and press **SET** to save.
5. Press **◀◀/▶▶** on the remote control to change the volume and press **SET** to save. The clock icon "🕒" shows that the alarm

! Note

- If you set the clock time, you can check the time by pressing **CLOCK** even when the player is turned off.
- If you set the clock time and alarm, you can check the alarm icon "🕒" by pressing **CLOCK** even when the player is turned off.
- If you set the clock time and alarm, you can check the alarm icon "🕒" and setting information by pressing **ALARM** even when the unit is turned off.
- Press **ALARM**, you can select a **ALARM** on / off mode.

Sleep Timer Setting

Press **SLEEP** repeatedly to select delay time between 10 and 180 minutes. After the delay time, the unit will be turned off.

To cancel the sleep function, press **SLEEP** repeatedly until "SLEEP 10" appears, and then press **SLEEP** once again while "SLEEP 10" is displayed.

! Note

- You can check the remaining time before the unit is turned off.
- Press **SLEEP**. The remaining time appears in the display window.

Dimmer

Press **SLEEP** once. The display window will be darkened by half. To cancel it, press **SLEEP** repeatedly until dim off.

Auto power down



This unit will turn off itself to save electric consumption in the case were main unit is not connected to external device and is not used for 20 minutes.

So does this unit after six hours since Main unit has been connected to other device using analogue input.

Advanced Operations



Listening to the sound from your external device

The unit can be used to play the sound from many types of external device. (Refer to page 16)



1. Connect the external device to the **AUX IN(L/R)** or **PORT. IN** connector of the unit.
2. Turn the power on by pressing  on the remote control or  on the unit.
3. Select the **AUX** or **PORTABLE** function by pressing **FUNCTION**.
4. Turn the external device and start playing it

Recording to USB











You can record a various sound source to USB. (CD, USB, AUX, PORTABLE, FM, AM)

1. Connect the USB device to the unit.
2. Select a function by pressing **FUNCTION**.
One track/file recording - You can record to USB after playing a track/file you want.
All tracks/files recording - You can record to USB after stop.
Program list recording - After showing the programmed list, you can record it to USB. (Refer to page 18)
3. Start the recording by pressing **USB REC** on the remote control or  **USB REC.** on the unit.
-If you connect both USB1 and USB2, press **USB REC** on the remote control or  **USB REC.** on the unit when USB1 or USB2 which you want to record blinks in the display window.
4. To stop recording, press  **ENTER** on the remote control or  on the unit.

Pausing recording



During recording, press  on the remote control or  on the unit to pause recording. Press it again to restart recording.
(Only TUNER, AUX, PORTABLE)

To select recording bit rate and speed

1. Press **USB REC** on the remote control or  **USB REC.** on the unit for longer than 3 seconds.
2. Use   on the remote control or   on the unit to select the bit rate.
3. Press **USB REC** on the remote control or  **USB REC.** on the unit again to select the recording speed.
4. Press   on the remote control or   on the unit to select a desired recording speed : (AUDIO CD only)
X1 SPEED
- You can listen to music while recording it.
X2 SPEED
- You can just record the music file.
5. Press **USB REC** on the remote control or  **USB REC.** on the unit to finish the setting.

Dubbing USB to USB

You can do dubbing various sound sources in USB1 to USB2 on USB function.

1. Connect a USB device including desired sound files to USB1.
2. Connect another USB device to USB2.
3. Start the recording by pressing **USB REC** on the remote control or  **USB REC.** on the unit.
4. To stop recording, press  **ENTER** on the remote control or  on the unit.

The making of unauthorized copies of copy-protected material, including computer programs, files, broadcasts and sound recordings, may be an infringement of copyrights and constitute a criminal offense. This equipment should not be used for such purposes.

Be responsible
Respect copyrights

! Note

- It is not supported to record music stored on bluetooth device.
- You can check the recording percentage rate for the USB record on the display window during the recording. (MP3/WMA CD Only)
- During recording MP3/WMA, there is no sound.
- When you stop recording during playback, the file that has been recorded at that time will be stored. (Except MP3/WMA files)
- Do not remove the USB device or turn off the unit during USB recording. If not, an incomplete file may be made and not deleted on PC.
- If USB recording does not work, the message like "NO USB", "ERROR", "FULL" or "NO REC" is displayed on the display window.
- Multi card reader device or External HDD can not be used for USB recording.
- A file is recorded by about 512 Mbyte when you record for a long term.
- You may not store more than 999 files.
- You can not record in AUTO DJ mode.
- It'll be stored as follows.

AUDIO CD	MP3/WMA
■ CD_REC └─ TRK_001 └─ TRK_002 └─ └─ └─ └─	■ FILE_REC └─ ABC(File name) └─ DEF(File name) └─ └─ └─
The other source*	TUNER
■ OTHERS_REC └─ AUDIO_001 └─ AUDIO_002 └─ └─	■ TUNER_REC └─ AUDIO_001_87-5FM └─ AUDIO_002_520AM └─ └─

TUNER : The current recording frequency is shown.

* : AUX, PORTABLE and the like.

Using a Bluetooth wireless technology

About Bluetooth

Bluetooth® is wireless communication technology for short range connection.

The sound may be interrupted when the connection is interfered by the other electronic wave or you connect the bluetooth in the other rooms.

Connecting individual devices under **Bluetooth**® wireless technology does not incur any charges. A mobile phone with **Bluetooth**® wireless technology can be operated via the Cascade if the connection was made via **Bluetooth**® wireless technology.

Available Devices : Mobile phone, MP3, Laptop, PDA.

Bluetooth Profiles

In order to use **Bluetooth**® wireless technology, devices must be able to interpret certain profiles. This unit is compatible with following profile.

A2DP (Advanced Audio Distribution Profile)

Listening to music stored on the Bluetooth devices

Before you start the pairing procedure, make sure the Bluetooth feature is turned on in to your Bluetooth device. Refer to your Bluetooth device's user guide. Once a pairing operation is performed, it does not need to be performed again.

1. Select the Bluetooth function by using the **FUNCTION**.
"BT READY" appears on the display window.
2. Operate the Bluetooth device and perform the pairing operation. When searching for this unit with the Bluetooth device, a list of the devices found may appear in the Bluetooth device display depending on the type of Bluetooth device. Your unit appears as "LG MINI (XX:XX)".

! Note

XX:XX means the last four digits of BT address. For example, if your unit has a BT address such as 9C:02:98:4A:**F7:08**, you will see "LG MINI (**F7:08**)" on your Bluetooth device.

3. Enter the PIN code.
PIN code : 0000

! Note

Depending on the Bluetooth device type, some device have a different pairing way.

4. When this unit successfully paired with your Bluetooth device, "BT PAIR" appears in the display window.
5. Listening to music.
To play a music stored on your Bluetooth device, refer to your Bluetooth device's user guide. According to your mobile phone's volume level, the volume level of Bluetooth will be adjusted.

! Note

- Sound from the main set can be distorted if you raise the volume of Bluetooth device up to two-thirds or more.
- When you use the Bluetooth function, adjust the volume of a Bluetooth device to a proper level to listen to.

! Note

- When using *Bluetooth*® technology, you have to make a connection between the unit and the bluetooth device as close as possible and keep the distance. However it may not work well in the case below :
 - There is an obstacle between the unit and the bluetooth device.
 - There is a device using same frequency with *Bluetooth*® technology such as a medical equipment, a microwave or a wireless LAN device.
- You should connect your Bluetooth device to this unit again when you restart it.
- The sound may be interrupted when the connection interfered by the other electronic wave.
- You cannot control the Bluetooth device with this unit.
- Pairing is limited one Bluetooth device per one unit and multi-pairing is not supported.
- Depending on the type of the device, you may not be able to use the Bluetooth function.
- You can enjoy wireless system using phone, MP3, Notebook, etc..
- When not connected the Bluetooth, "BT" and "BT READY" appears on the control panel.
- When someone stands and interrupts communication between Bluetooth device and the player, the connection will be disconnected.
- The more distant between the unit and the bluetooth device, the lower the sound quality becomes.
- When Bluetooth connection is disconnected, connect the bluetooth device to the unit again.
- After your device is connected to the unit via Bluetooth, the function switches to BT automatically. But while recording, it doesn't switch to BT.

Using Bluetooth App

About "LG Bluetooth Remote" App

"LG Bluetooth Remote" app brings a suite of new features to this unit.

To enjoy more features, you are recommended to download and install free "LG Bluetooth Remote" app.

Install "LG Bluetooth Remote App" by using QR code

1. Install "LG Bluetooth Remote" app through QR code. Use the scanning software to scan the QR code.



(Android OS)

2. Tap an icon for installation.
3. Tap an icon for downloading.

! Note

- Make sure that your Bluetooth device is connected to the Internet.
- Make sure that your Bluetooth device has a scanning software application. If you don't have one, download one from "Google Android Market (Google Play Store)".

Install "LG Bluetooth Remote" App through "Google Android Market (Google Play Store)"

1. Tap the "Google Android Market (Google Play Store)" icon.
2. In the search bar, type in the "LG Bluetooth Remote" and search it.
3. In the search result list, find and tap "LG Bluetooth Remote" to start downloading Bluetooth app.
4. Tap an icon for installation.
5. Tap an icon for downloading.

! Note

- Make sure that your Bluetooth device is connected to the Internet.
- Make sure that your Bluetooth device is equipped with "Google Android Market (Google Play Store)".
- If you want to get more information, refer to explanation of BT app in "Google Android Market (Google Play Store)".

Activate Bluetooth with “LG Bluetooth Remote” App

“LG Bluetooth Remote” app helps to connect your bluetooth device to this unit.

1. Tap “LG Bluetooth Remote” app icon on the home screen to open “LG Bluetooth Remote” app, and go to the main menu.
2. Tap [Setting] and select the unit you want.
3. If you want to get more information to operate, tap [Setting] and [Help].

Note

- BT app will be available in the software version as follow;
 - Android O/S : Ver 2.3.3 (or later)
- This unit does not support the multi-pairing. If this unit is already connected with other Bluetooth device, disconnect that device and then try again
- If you use “LG Bluetooth Remote” app for operation, there would be some differences between “LG Bluetooth Remote” app and the supplied remote control. Use the supplied remote control as necessary.
- Depending on the Bluetooth device, “LG Bluetooth Remote” app may not work.
- The connection you’ve made may be disconnected if you select other application or change the setting of the connected device via “LG Bluetooth Remote” app. In such a case, please check the connection status.
- To prevent a malfunction, you are recommended to connect only one device to this unit.
- After connection of BT app, music may be output from your device. In this case, try connecting procedure again.

Troubleshooting

Problem	Cause & Correction
No Power.	<ul style="list-style-type: none"> • The power cord is not plugged in. Plug in the power cord. • Check whether electricity failed. Check the condition by operating other electronic devices.
No sound.	<ul style="list-style-type: none"> • Check whether you select right function. Press FUNCTION and check the selected function. • Speaker cables are not connected correctly. Connect speaker cables correctly.
The unit does not start playback.	<ul style="list-style-type: none"> • An unplayable disc is inserted. Insert a playable disc. • No disc is inserted. Insert a disc. • The disc is dirty. Clean the disc. (Refer to 31 page) • The disc is inserted upside down. Place the disc with the label or printed side facing upwards.
Radio stations cannot be tuned in properly.	<ul style="list-style-type: none"> • The antenna is positioned or connected poorly. Connect the antenna securely. • The signal strength of the radio station is too weak. Tune to the station manually. • No stations have been preset or preset stations have been cleared (when being tuned by scanning preset channels). Preset some radio stations, see page 20 for details.
The remote control does not work properly.	<ul style="list-style-type: none"> • The remote control is too far from the unit. Operate the remote control within about 23 ft (7 m). • There is an obstacle in the path of the remote control and the unit. Remove the obstacle. • The batteries in the remote control are exhausted. Replace the batteries with new ones.

Specifications

General					
Model	CM4740	CM4640	CM4540	CM4440	CM4340
Power requirements	Refer to the main label.				
Power consumption	Refer to the main label.				
Dimensions (W x H x D)	(206 x 308 x 284) mm				
Net Weight (Approx.)	3.1 kg	3.1 kg	3.0 kg	3.0 kg	3.0 kg
Operating temperature	5 °C to 35 °C (41 °F to 95 °F)				
Operating humidity	5 % to 90 %				
Bus Power Supply	5 V  500 mA				

Inputs	
AUX IN	2.0 Vrms (1 kHz, 0 dB), 75 Ω, RCA jack (L, R)
Port In	1.2 Vrms (3.5 mm stereo jack)

Tuner	
FM Tuning Range	87.5 to 108.0 MHz or 87.50 to 108.00 MHz
AM Tuning Range	522 to 1620 kHz, 520 to 1710 kHz or 522 to 1710 kHz

Amplifier						
Model	CM4740	CM4640	CM4540	CM4440	CM4340	
Stereo mode		270 W + 270 W (3 Ω at 1 kHz, THD 20 %)	275 W + 275 W (3 Ω at 1 kHz, THD 20 %)	200 W + 200 W (3 Ω at 1 kHz, THD 20 %)	200 W + 200 W (3 Ω at 1 kHz, THD 20 %)	110 W + 110 W (4 Ω at 1 kHz, THD 20 %)
Surround mode	Front	270 W + 270 W (3 Ω at 1 kHz, THD 20 %)	275 W + 275 W (3 Ω at 1 kHz, THD 20 %)	200 W + 200 W (3 Ω at 1 kHz, THD 20 %)	200 W + 200 W (3 Ω at 1 kHz, THD 20 %)	110 W + 110 W (4 Ω at 1 kHz, THD 20 %)
	Subwoofer	260 W (3 Ω at 60 Hz, THD 20 %)	-	200 W (3 Ω at 60 Hz, THD 20 %)	-	-

CD	
Frequency Response	100 to 20,000 Hz
Signal-to-noise ratio	75 dB
Dynamic range	75 dB

Speaker specifications

Front speaker			
Model	CMS4740F	CMS4540F	CMS4340F
Type	2 Way 2 Speaker		
Impedance	3 Ω		4 Ω
Rated Input Power	275 W	200 W	110 W
Max. Input power	550 W	400 W	220 W
Net Dimensions (W x H x D)	(300 x 358 x 265) mm	(266 x 306 x 263) mm	(200 x 306 x 200) mm
Net Weight	5.5 kg	3.1 kg	2.2 kg

Subwoofer speaker		
Model	CMS4740W	CMS4540W
Type	1 Way 1 Speaker	
Impedance	3 Ω	
Rated Input Power	260 W	200 W
Max. Input power	520 W	400 W
Net Dimensions (W x H x D)	(310 x 358 x 305) mm	(266 x 306 x 232) mm
Net Weight	5.7 kg	4.7 kg

- Design and specifications are subject to change without notice.

Maintenance

Handling the Unit

When shipping the unit

Please save the original shipping carton and packing materials. If you need to ship the unit, for maximum protection, re-pack the unit as it was originally packed at the factory.

Keeping the exterior surfaces clean

Do not use volatile liquids such as insecticide spray near the unit.

Wiping with strong pressure may damage the surface.

Do not leave rubber or plastic products in contact with the unit for a long period of time.

Cleaning the unit

To clean the player, use a soft, dry cloth. If the surfaces are extremely dirty, use a soft cloth lightly moistened with a mild detergent solution. Do not use strong solvents such as alcohol, benzine, or thinner, as these might damage the surface of the unit.

Maintaining the Unit

The unit is a high-tech, precision device. If the optical pick-up lens and disc drive parts are dirty or worn, the picture quality could be diminished. For details, please contact your nearest authorized service center.

Notes on Discs

Handling Discs

Never stick paper or tape on the disc.

Storing Discs

After playing, store the disc in its case. Do not expose the disc to direct sunlight or sources of heat and never leave it in a parked car exposed to direct sunlight.

Cleaning Discs

Do not use strong solvents such as alcohol, benzene, thinner, commercially available cleaners, or anti-static spray intended for old vinyl records.

Trademarks and Licenses



Bluetooth® wireless technology is a system which allows radio contact between electronic devices.

Connecting individual devices under *Bluetooth*® wireless technology does not incur any charges. A mobile phone with *Bluetooth*® wireless technology can be operated via the Cascade if the connection was made via *Bluetooth*® wireless technology.

The *Bluetooth*® word mark and logos are owned by the *Bluetooth*® SIG, Inc. and any use of such marks by LG Electronics is under license.

Other trademarks and trade names are those of their respective owners.

