



ENGLISH

FRANÇAIS

OWNER'S MANUAL

2.1 ch Sound Bar

Please read this manual carefully before operating your set and retain it for future reference.

NB3540 (NB3540, S34A2-D)



MFL68164329

www.lg.com



Safety Information



CAUTION: TO REDUCE THE RISK OF ELECTRIC SHOCK DO NOT REMOVE COVER (OR BACK) NO USER-SERVICEABLE PARTS INSIDE REFER SERVICING TO QUALIFIED SERVICE PERSONNEL.

This lightning flash with arrowhead symbol within an equilateral triangle is intended to alert the user to the presence of uninsulated dangerous voltage within the product's enclosure that may be of sufficient magnitude to constitute a risk of electric shock to persons.



The exclamation point within an equilateral triangle is intended to alert the user to the presence of important operating and maintenance (servicing) instructions in the literature accompanying the product.



WARNING: TO PREVENT FIRE OR ELECTRIC SHOCK HAZARD, DO NOT EXPOSE THIS PRODUCT TO RAIN OR MOISTURE.

CAUTION: The apparatus shall not be exposed to water (dripping or splashing) and no objects filled with liquids, such as vases, shall be placed on the apparatus.

WARNING: Do not install this equipment in a confined space such as a book case or similar unit.

CAUTION: Do not block any ventilation openings. Install in accordance with the manufacturer's instructions.

Slots and openings in the cabinet are provided for ventilation and to ensure reliable operation of the product and to protect it from over heating. The openings shall be never be blocked by placing the product on a bed, sofa, rug or other similar surface. This product shall not be placed in a built-in installation such as a bookcase or rack unless proper ventilation is provided or the manufacturer's instruction has been adhered to.

CAUTION concerning the Power Cord

Most appliances recommend they be placed upon a dedicated circuit;

That is, a single outlet circuit which powers only that appliance and has no additional outlets or branch circuits. Check the specification page of this owner's manual to be certain. Do not overload wall outlets. Overloaded wall outlets, loose or damaged wall outlets, extension cords, frayed power cords, or damaged or cracked wire insulation are dangerous. Any of these conditions could result in electric shock or fire. Periodically examine the cord of your appliance, and if its appearance indicates damage or deterioration, unplug it, discontinue use of the appliance, and have the cord replaced with an exact replacement part by an authorized service center. Protect the power cord from physical or mechanical abuse, such as being twisted, kinked, pinched, closed in a door, or walked upon. Pay particular attention to plugs, wall outlets, and the point where the cord exits the appliance. To disconnect power from the mains, pull out the mains cord plug. When installing the product, ensure that the plug is easily accessible.

NOTICE: For Product Identification and Compliance/Safety labeling information please refer to Main Label on the bottom of Unit.

4 Getting Started

This device is equipped with a portable battery or accumulator.

Safety way to remove the battery from the equipment: Remove the old battery or battery pack, follow the steps in reverse order than the assembly. To prevent contamination of the environment and bring on possible threat to human and animal health, the old battery or the battery put it in the appropriate container at designated collection points. Do not dispose of batteries or battery together with other waste. It is recommended that you use local, free reimbursement systems batteries and accumulators. The battery should not be exposed to excessive heat such as sunshine, fire or the like.

Table of Contents

1 Getting Started

- 3 Safety Information
- 6 Unique features
- 6 Introduction
 - 6 – Symbols used in this manual
- 6 Accessories
- 7 Remote control
- 8 Front panel
- 8 Rear panel
- 9 Installing the sound bar
- 10 Mounting the main unit on a wall

2 Connecting

- 12 Connecting the AC adapter
- 12 Wireless subwoofer connection
- 13 Connecting to your TV
 - 13 – Using an OPTICAL cable
- 14 Optional equipment connection
 - 14 – PORT. (Portable) IN connection
 - 14 – OPTICAL IN connection
 - 14 – USB connection
 - 15 – Compatible USB devices
 - 15 – USB device requirement
 - 16 – Playable file

3 Operating

- 17 Basic operations
 - 17 – USB operation
- 18 Other operations
 - 18 – DRC (Dynamic Range Control)
 - 18 – AV Sync
 - 18 – Turn off the sound temporarily
 - 18 – Displaying file and input source
 - 18 – Sleep timer setting
 - 19 – AUTO POWER On/Off
 - 19 – Auto function change
 - 20 – LG Sound Sync
- 22 Using Bluetooth technology
 - 22 – Listening to music stored on the Bluetooth devices

- 23 Using Bluetooth App
 - 23 – Install “LG Bluetooth Remote” App onto Your Bluetooth Device
- 24 – Activate Bluetooth with “LG Bluetooth Remote” App
- 25 Sound adjustment
 - 25 – Setting sound effect
 - 25 – Adjust volume level automatically
 - 25 – Adjust the woofer level settings
- 26 Controlling a TV with the supplied remote control
 - 26 – Setting up the remote to control your TV

4 Troubleshooting

- 27 Troubleshooting

5 Appendix

- 29 Trademarks and licenses
- 30 Specifications
- 31 Maintenance
 - 31 – Handling the unit

1

2

3

4

5

Unique features

Auto power down

This unit will turn off by itself for energy saving consumption.

Portable In

Listen to music from your portable device. (MP3, Notebook, etc)

Speaker (easy) setup

Listen to sound from TV, DVD or Digital device with vivid 2.1 ch mode.

LG Sound Sync

Controls volume level of this unit by the remote control of your LG TV that is compatible with LG Sound Sync.

Introduction

Symbols used in this manual

! Note

Indicates special notes and operating features.

! Caution

Indicates cautions for preventing possible damages from abuse.

Accessories

Please check and identify the supplied accessories.

Designs and specifications of the accessories are subject to change without prior notice.

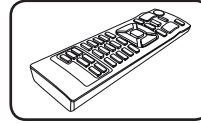

Remote control (1)

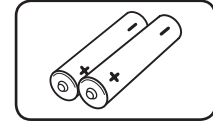

Batteries (2)

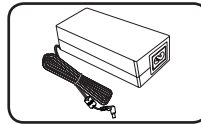

AC adapter (1)

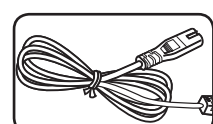

Power cord (1)

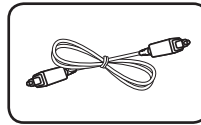

Optical cable (1)

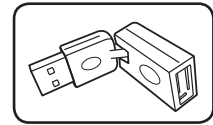

USB gender changer (1)

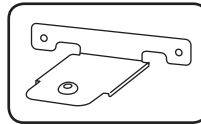

Wall bracket (2)

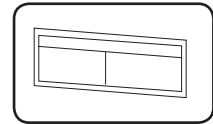

Wall bracket install guide (1)

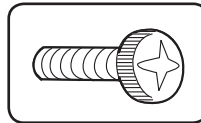

Screws (2)

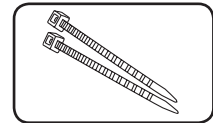

Cable ties for arranging cables (2)

Remote control

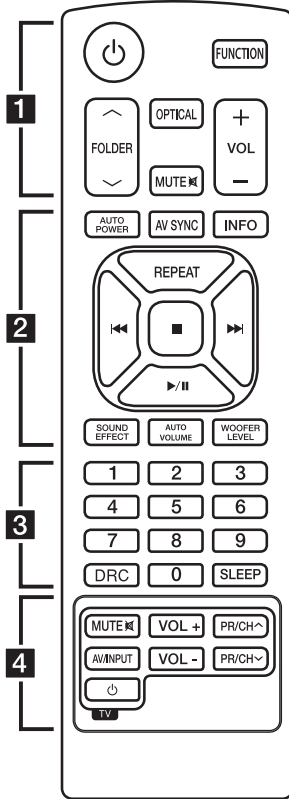

Battery Installation

Remove the battery cover on the rear of the Remote Control, and insert two R03 (size AAA) batteries with \oplus and \ominus matched correctly.

..... **1**

Power : Switches the unit ON or OFF.

FUNCTION : Selects the function and the input source.

FOLDER \wedge / \vee : Searches a folder on USB device.

OPTICAL : Changes input source to OPTICAL directly.

MUTE \boxtimes : Mutes the sound.

VOL \pm / $-$: Adjusts speaker volume.

..... **2**

AUTO POWER : Turns on or off AUTO POWER function. (Refer to the page 19.)

AV SYNC : Synchronizes the audio and video.

INFO : Displays the information of a file or an input source.

REPEAT : Listen to your files repeatedly or randomly.

◀◀ / ▶▶ (Skip/Search) :

- Skips Fast backward or Forward.

- Searches for a section within a file.

■ (Stop) : Stops playback.

▶ / || (Play/Pause) : Starts playback. / Pauses playback.

SOUND EFFECT : Selects a sound effect mode.

AUTO VOLUME : Turns on and off the AUTO VOLUME mode.

WOOFER LEVEL : Sets the sound level of woofer.

..... **3**

0 to 9 numerical buttons : Selects a file directly.

DRC : Turns on or off DRC function.

SLEEP : Sets the system to turn off automatically at a specified time.

..... **4**

TV Control buttons : See page 26.

1

Getting Started

Front panel

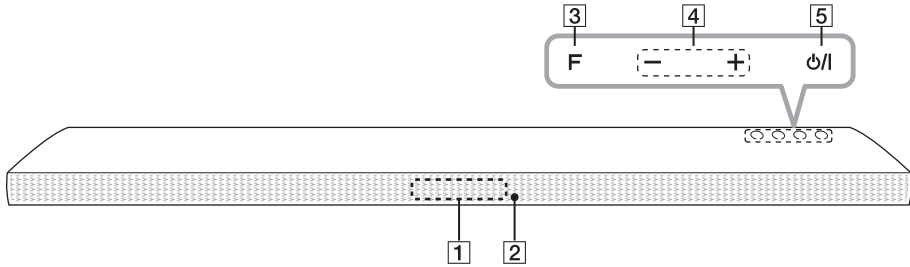

1 Display window

2 Remote sensor

Standby LED
It lights up in red on standby mode.

3 F (Function)

Selects the function and input source.

4 - / + (Volume)

Adjusts volume level.

5 ⏻ / | (Standby/On)

Rear panel

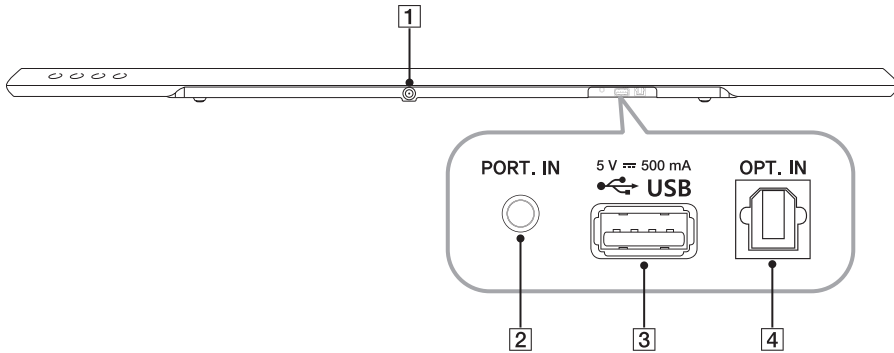

1 DC. IN 25 V $\overline{\text{=}}$ 2 A

2 PORT. IN : Portable input

3 USB port

4 OPT. IN : Optical input

Installing the sound bar

You can hear the sound by connecting the unit to the other device : TV, Blu-ray disc player, DVD player, etc.

Place the unit in front of the TV and connect it to the device you want. (Refer to pp. 13 - 15.)

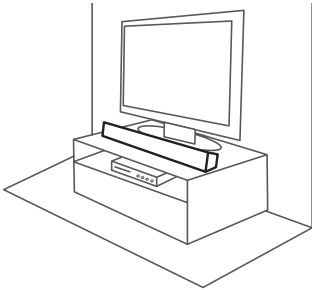

Caution

For best performance of wireless connection such as Bluetooth or wireless subwoofer, do not install the unit on Metallic furniture because wireless connection communicates through a module positioned on the bottom of the unit.

1

Getting Started

Mounting the main unit on a wall

You can mount the main unit on a wall.

Preparation materials

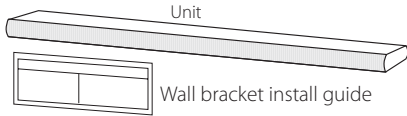

(Not supplied)

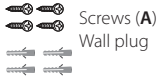

! Note

You should connect the supplied USB gender changer in advance of mounting the unit on the wall for using a USB connection.

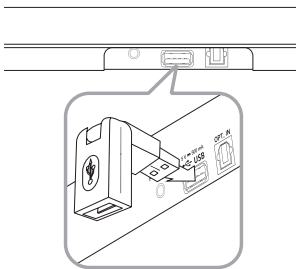

1. Match the TV's BOTTOM EDGE of Wall bracket install guide with the bottom of TV and attach to the position.

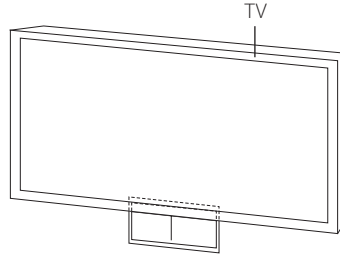

2. When you mount it on a wall (concrete), use the wall plugs. You should drill some holes. A guide sheet (Wall bracket install guide) is supplied to drill. Use the sheet to check the point to drill.

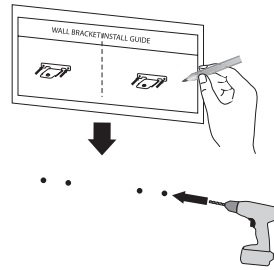

3. Remove the Wall bracket install guide.

4. Fix the brackets with screws (A) as shown in the illustration below.

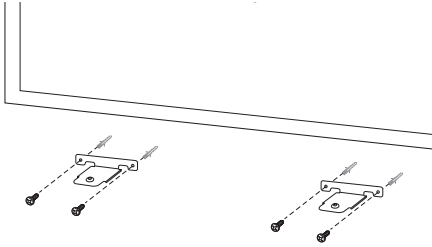

Note

Screws (A) and Wall Plugs are not supplied for mounting the unit. We recommend the Hilti (HUD-1 6 x 30) for the mounting.

5. Put the unit on the brackets to match screw holes on the bottom of the unit.

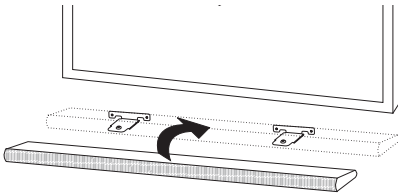

6. Fix the unit with the screws firmly.

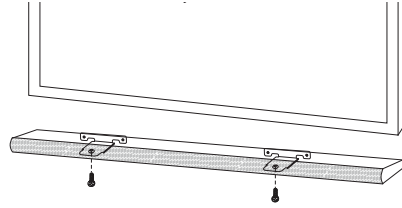

Note

To detach the unit, perform it in reverse order.

Caution

- Do not install this unit upside down. It can damage the parts of this unit or be the cause of personal injury.
- Do not hang onto the installed unit and avoid any impact to the unit.
- Secure the unit firmly to the wall so that it does not fall off. If the unit falls off, it may result in an injury or damage to the product.
- When the unit is installed on a wall, please make sure that a child does not pull any of connecting cables, as it may cause it to fall.

Connecting the AC adapter

1. Connect the supplied AC power cord to the AC adapter.
2. Connect the AC adapter cable to DC. IN adapter input.
3. Plug the AC power cord into an AC outlet.

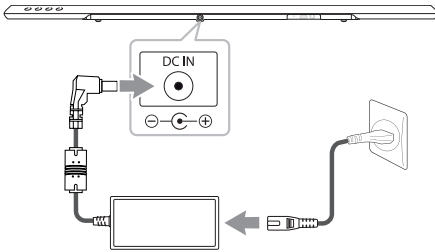

Caution

Only use the AC adapter supplied with this device. Do not use a power supply from another device or manufacturer. Using any other power cable or power supply may cause damage to the device and void your warranty.

Wireless subwoofer connection

LED indicator of wireless subwoofer

LED Color	Status
Yellow-green (Blink)	The connection is trying.
Yellow-green	The connection is completed.
Red	The wireless subwoofer is in standby mode or the connection is failed.
Off (No display)	The power cord of wireless subwoofer is disconnected.

Setting up the wireless subwoofer for the first time

1. Connect the power cord of the wireless subwoofer to the outlet.
2. Turn on the main unit : The main unit and wireless subwoofer will be automatically connected.

Manually pairing wireless subwoofer

When your connection is not completed, you can see the red LED or the blinking of yellow-green LED on the wireless subwoofer and the subwoofer does not make sound. To solve the problem, follow the below steps.

1. Adjust volume level of the main unit to minimum.
 - "VOL MIN" appears on the display window.
2. Press and hold **MUTE** (Mute) on the remote control for about 3 seconds.
 - "W RESET" appears on the display window briefly.

- If the LED of the wireless subwoofer already blinks in yellow-green continually, you can skip this step.

Press and hold **PAIRING** on the back of the wireless subwoofer for more than 5 seconds.

- The LED of the wireless subwoofer lights up alternately in red and yellow-green.
- Disconnect the power cord of the main unit and the wireless subwoofer.
 - Connect them again after the LED of the main unit and the wireless subwoofer is fully turned off.

The main unit and the wireless subwoofer will be paired automatically when you turn on the main unit.

- When the connection is completed, you can see the yellow-green LED on the subwoofer.

! Note

- It takes a few seconds (and may take longer) for the main unit and the subwoofer to communicate with each other and make sounds.
- The closer the main unit and the subwoofer, the better sound quality. It is recommended to install the main unit and the subwoofer as close as possible (within 5 m) and avoid the cases below.
 - There is an obstacle between the main unit and the subwoofer.
 - There is a device using same frequency with this wireless connection such as a medical equipment, a microwave or a wireless LAN device.

Connecting to your TV

Using an OPTICAL cable

- Connect the OPT. IN jack on the back of the unit to OPTICAL OUT jack on the TV using an OPTICAL cable.

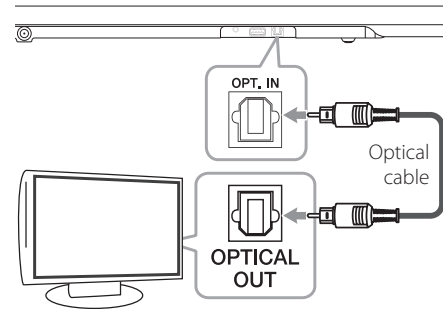

- Set the INPUT source to OPTICAL. Press repeatedly **FUNCTION** on the remote control or **F** on the unit until the function is selected.

To directly select the OPTICAL function, press **OPTICAL** on the remote control.

! Note

- You can enjoy the TV audio through the speakers of this unit. In the case of some TV models, you must select the external speaker option from the TV menu. (For details, reference your TV user manual.)
- Set up the sound output of TV to listen to the sound through this unit :
TV setting menu → [Sound] → [TV Sound output] → [External speaker (Optical)]
- Details of TV setting menu vary depending on the manufacturers or models of your TV.

Optional equipment connection

2
Connecting

PORT. (Portable) IN connection

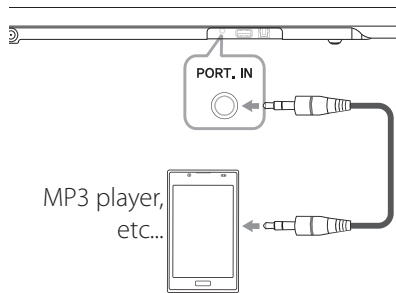

Listening to music from your portable player

The unit can be used to play the music from many types of portable players or external devices.

1. Connect the portable player to the PORT. (Portable) IN connector of the unit.
2. Turn the power on by pressing (Power).
3. Select the PORTABLE function by pressing **FUNCTION** on the remote control or **F** on the unit until the function is selected.
4. Turn on the portable player or external device and start playing it.

OPTICAL IN connection

Connect an optical output jack of external devices to the OPT. IN jack.

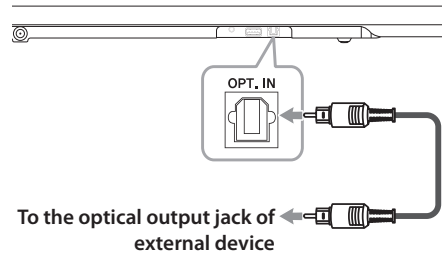

Speaker (easy) setup

Listens to sound from TV, DVD or Digital Device with 2.1 or 2 ch mode.

1. Connect the OPT. IN jack on the back of the unit to optical out jack of your TV (or digital device etc.)
2. Select the input source to OPTICAL by pressing **FUNCTION** on the remote control or **F** on the unit until the function is selected.
To directly select the OPTICAL function, press **OPTICAL** on the remote control.
3. Listen to sound with 2.1 or 2 ch speaker.
4. Press **OPTICAL** to exit from OPTICAL.
Function is returned to previous one.

USB connection

Connect USB memory device to the USB port on the back of the unit.

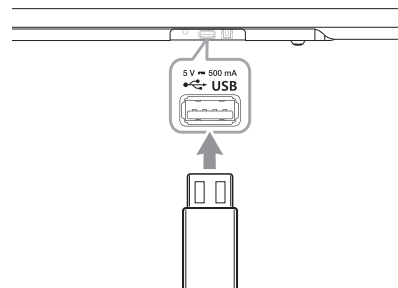

Connect a USB to the USB gender changer when the unit is mounted on the wall.

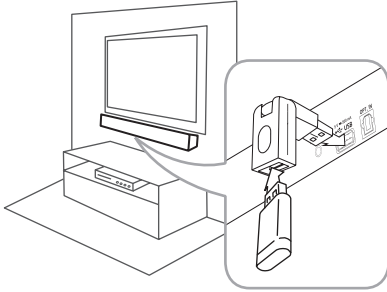

For more information of playing files on a USB, refer to the page 17.

Removing the USB Device from the unit.

1. Choose a different function/mode or press **■** twice in a row.
2. Remove the USB device from the unit.

Compatible USB devices

- MP3 Player : Flash type MP3 player.
- USB Flash Drive : Devices that support USB 1.1.
- The USB function of this unit does not support some USB devices.

USB device requirement

- Devices which require additional program installation connected to a computer, are not supported.
- Do not extract the USB device while in operation.
- For a large capacity USB, it may take longer than a few minutes to be searched.
- To prevent data loss, back up all data.
- This unit is not supported when the total number of files is 1000 or more.
- The unit's USB Port cannot be connected to PC. The unit can not be used as a storage device.
- The exFAT file system is not supported on this unit. (FAT16/FAT32/NTFS systems are available.)
- Depending on some devices, it may not available to recognize the followings on this unit.
 - External HDD
 - Card readers
 - Locked devices
 - Hard type USB devices
 - USB hub
 - Using USB extension cable
 - iPhone/iPod/iPad
 - Android device

Playable file

Sampling Frequency

MP3 : within 32 to 48 kHz
 WMA : within 32 to 48 kHz
 OGG : within 32 to 48 kHz
 FLAC : within 32 to 192 kHz
 WAV : within 32 to 48 kHz

Bitrate

MP3 : within 80 to 320 kbps
 WMA : within 56 to 128 kbps
 OGG : within 50 to 500 kbps
 FLAC : within 500 to 5000 kbps
 WAV : within 500 to 5000 kbps

- Maximum files : Under 999
- A protected file by DRM (Digital rights management) cannot be played on the unit.
- Video files in the USB storage device can not be played.
- Depending on the performance of your USB device, playback may not work well.

Note

- Folders and files on the USB are recognized as below.

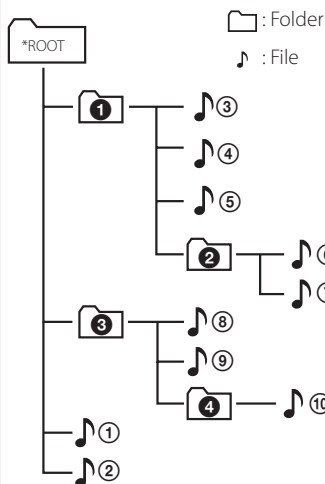

- If there is no file in a folder, the folder will not appear.
- File will be played from file 1 to file 10 one by one.
- Files and folders will be presented in order recorded and may be presented differently depending on the recording circumstances.
- This unit can display file or folder names that contain numbers or English characters only.
- *ROOT : The first screen you can see when a computer recognizes the USB as "ROOT".

Basic operations

USB operation

1. Connect the USB device to the USB port.
2. Select the USB function by pressing **FUNCTION** on the remote control or **F** on the unit until the function is selected.

To	Do this
Stop	Press ■ .
Playback	Press ▶/ .
Pause	During playback, press ▶/ .
Skip to the next/ previous file	During playback, press ▶▶ on the remote control to go to the next file. Playing less than 2 seconds, press ◀◀ on the remote control to go to the previous file. Playing after 3 seconds, press ◀◀ on the remote control to go to the beginning of the file.
Search for a section within a file	Press and hold ◀◀/▶▶ during playback and release it at the point you want to listen to. (except FLAC and OGG files)
Play repeatedly or randomly	Press REPEAT on the remote control repeatedly, the display will be changed in the following order, OFF → RPT 1 → RPT DIR (DIRECTORY) → RPT ALL → RANDOM.
Select a file directly	Press 0 to 9 numerical buttons on the remote control to go to the desired file directly.
Search a folder	Press FOLDER ▲/▼ on the remote control.
Resume playback	This unit memorizes a current song which is played before changing the function or turning off the unit.

! Note

- The resume point may be cleared when you pull out the power cord or removing the USB device from the unit.
- Repeat/Random playback operates as follows.

On Display	Description
OFF	Plays songs on USB device in order.
RPT1	Plays a same song repeatedly.
RPT DIR	Plays songs in a folder repeatedly.
RPT ALL	Plays all the songs on USB device repeatedly.
RANDOM	Plays songs randomly.

Other operations

DRC (Dynamic Range Control)

Make the sound clear when the volume is turned down (Dolby Digital only). Set to [DRC ON] by using **DRC**.

AV Sync

When receiving audio signals from TV, sound and images may not be matched. In the case, this function can adjust the delay time.

1. Press **AV SYNC**.
2. Use **◀◀/▶▶** to scroll up and down through the delay amount, which you can set at anything between 0 and 300 ms.

! Note

This function does not operate on USB function.

Turn off the sound temporarily

Press **MUTE** to mute your unit.

You can mute your unit, for example, to answer the telephone, "MUTE" is displayed in the display window.

To cancel it, press **MUTE** again on the remote control or change the volume level.

Displaying file and input source

You can display various information of the input source by pressing **INFO**.

USB : File information contained on a USB (MP3/WMA/OGG/FLAC/WAV)

OPTICAL : Audio format, Audio channel

Sleep timer setting

Press **SLEEP** repeatedly to select the desired time period options (in minutes):

DISPLAY OFF (display window will turn off) ->

DIMMER (display window will be darkened by half)

-> Sleep timer value -> Display on

To check the remaining time, press **SLEEP**.

To cancel the sleep function, press **SLEEP** repeatedly until "10MIN" appears, and then press **SLEEP** once again while "10MIN" is displayed.

! Note

You can check the remaining time before the unit turns off. Press **SLEEP** the remaining time appears in the display window.

Auto power down

This unit will be off itself to save electric consumption in the case main unit is not connected to external device and is not used for 20 minutes.

So does this unit after six hours since Main unit has been connected to other device using analog input.

AUTO POWER On/Off

This unit automatically turns on by an input source : Optical, LG TV or Bluetooth.

When you turn on your TV or an external device connected to this unit, this unit recognizes the input signal and select the suitable function. You can hear the sound from your device.

If you try to connect your Bluetooth device, this unit turns on and ready to pair. Connect your Bluetooth device and play your music.

This function turns on or off each time you press **AUTO POWER**.

! Note

- After the unit is turned on by AUTO POWER function, it will be automatically turned off if there is no signal for a certain period of time from the TV connected by LG Sound Sync (Optical/Wireless).
- After the unit is turned on by AUTO POWER function, it will be automatically turned off if there is no signal for a certain period of time from the external device.
- If you turned off the unit directly, it cannot be turned on automatically by AUTO POWER function. However the unit can be turned on by AUTO POWER function when optical signal comes in after 5 seconds of no signal.
- Depending on the connected device, this function may not operate.
- If you disconnect Bluetooth connection by this unit, some Bluetooth devices try to connect to the unit continually. Therefore it is recommended to disconnect the connection before turn off the unit.

Auto function change

This unit recognizes input signals such as optical, Bluetooth and LG TV and then changes suitable function automatically.

When optical signal comes in

When you turn on the external device connected to this unit by an optical cable, this unit change the function to optical. You can hear the sound from your device.

When you try to connect Bluetooth device

When you try to connect your Bluetooth device to this unit, Bluetooth function is selected. Play your music on the Bluetooth device.

When LG TV signal comes in

When you turn on your LG TV connected by LG Sound Sync, this unit changes the function to LG TV. You can hear the sound from your TV.

When connecting "LG Bluetooth Remote" app

When you connect your Bluetooth device by using "LG Bluetooth Remote" app, this unit keeps the current function as well as you can control the unit by the app.

Note

- To change to optical function, it needs 5 seconds of no signal.
- If you are using LG TV function, this unit does not react to the Bluetooth connection.
- If you are using Bluetooth function, this unit does not react to LG TV connection.
- Auto function change does not operate if your Bluetooth device or LG TV has never been paired with this unit.
- If you disconnect Bluetooth connection by this unit, some Bluetooth devices try to connect to the unit continually. Therefore it is recommended to disconnect the connection before changing the function.
- If you connect Bluetooth device by "LG Bluetooth Remote" app when this unit is ready to pair with LG TV, the unit change the function to Bluetooth.

LG Sound Sync**Sound Sync**
Wireless

You can control some functions of this unit by your TV's remote control with LG Sound Sync. It is compatible with the LG TV that supports LG Sound Sync. Make sure of the LG Sound Sync logo on your TV.

Controllable function by LG TV's remote control :
Volume up/down, mute

Refer to the TV's instruction manual for the details of LG Sound Sync.

Make one of the following connections, depending on the capabilities of your equipment.

Note

- You can also use the remote control of this unit while using LG Sound Sync. If you use TV's remote control again, the unit synchronizes with the TV.
- When the connection fails, make sure of the condition of the TV and power.
- Make sure of the condition of this unit and the connection in the cases below when using LG Sound Sync.
 - Turn off the unit.
 - Changing the function to the others.
 - Disconnecting the optical cable.
 - Disconnecting the wireless connection caused by interference or a distance.
- The amount of time to turn off this unit is different depending on your TV when you set AUTO POWER function to ON.

With wired connection

1. Connect your LG TV to the unit by using an optical cable.

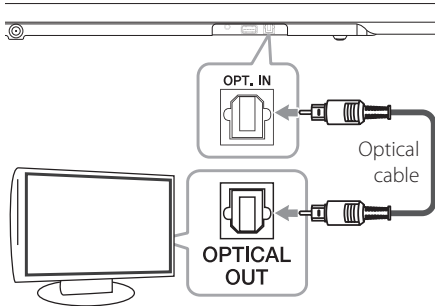

2. Set up the sound output of TV to listen to the sound through this unit :
TV setting menu → [Sound] → [TV Sound output] → [LG Sound Sync (Optical)]
3. Turn on the unit by pressing **Power** on the remote control.
4. Select **OPTICAL** function by using **FUNCTION** on the remote control or **F** on the unit until the function is selected.
You can see "LG OPT" on the display window if connecting normally between this unit and your TV.

With wireless connection

1. Turn on the unit by pressing **Power** on the remote control.
2. Select LG TV function by using **FUNCTION** on the remote control or **F** on the unit until the function is selected.

3. Set up the sound output of TV to listen to the sound through this unit :
TV setting menu → [Sound] → [TV Sound output] → [LG Sound Sync (Wireless)]

"PAIRED" appears on the display window for about 3 seconds and then you can see "LG TV" on the display window if connecting normally between this unit and your TV.

! Note

- If you turned off the unit directly by pressing **Power**, LG Sound Sync (Wireless) will be disconnected. To use this function again, you should reconnect the TV and the unit.
- Details of TV setting menu vary depending on the manufacturers or models of your TV.
- The device with **Bluetooth**® wireless technology will be disconnected, if Sound Sync function is selected. "LG Bluetooth Remote" app you've already connected is disconnected either.

Using Bluetooth technology

About Bluetooth

Bluetooth is wireless communication technology for short range connection.

The sound may be interrupted when the connection interfered by the other electronic wave or you connect the bluetooth in the other rooms.

Connecting individual devices under **Bluetooth®** wireless technology does not incur any charges. A mobile phone with **Bluetooth®** wireless technology can be operated via the Cascade if the connection was made via **Bluetooth®** wireless technology.

Available Devices : Mobile phone, MP3, Laptop, PDA etc.

Bluetooth Profiles

In order to use **Bluetooth®** wireless technology, devices must be able to interpret certain profiles. This unit is compatible with following profile.

A2DP (Advanced Audio Distribution Profile)

Listening to music stored on the Bluetooth devices

Pairing your unit and Bluetooth device

Before you start the pairing procedure, make sure the Bluetooth feature is turned on in to your Bluetooth device. Refer to your Bluetooth device's user guide. Once a pairing operation is performed, it does not need to be performed again.

1. Select the Bluetooth function by using **FUNCTION** on the remote control or **F** on the unit until the function is selected. Appears "BT" and then "READY" in display window.
2. Operate the Bluetooth device and perform the pairing operation. When searching for this unit with the Bluetooth device, a list of the devices found may appear in the Bluetooth device display depending on the type of Bluetooth device. Your unit appears as "LG SOUND BAR (XX:XX)".

Note

- XX:XX means the last four digits of Bluetooth address. For example, if your unit has a Bluetooth address such as 9C:02:98:4A:F7:08, you will see "LG SOUND BAR (F7:08)" on your Bluetooth device.
- Depending on the Bluetooth device type, some device have a different pairing way. Enter the PIN code (0000) as needed.

3. When this unit is successfully connected with your Bluetooth device, "PAIRED" will appear on the display window.
4. Listen to music.
To play a music stored on your Bluetooth device, refer to your Bluetooth device's user guide.

! Note

- When using **Bluetooth®** technology, you have to make a connection between the unit and the bluetooth device as close as possible and keep the distance. However it may not work well in the case below :
 - There is a obstacle between the unit and the bluetooth device.
 - There is a device using same frequency with **Bluetooth®** technology such as a medical equipment, a microwave or a wireless LAN device.
- This unit supports Bluetooth auto pairing. However it does not operate in the case below :
 - When you restart this unit.
 - When you return to Bluetooth function after using LG TV function.
- The sound may be interrupted when the connection interfered by the other electronic wave.
- You cannot control the Bluetooth device with this unit.
- Pairing is limited one Bluetooth device per one unit and multi-pairing is not supported.
- Depending on the type of the device, you may not be able to use the Bluetooth function.
- You can enjoy wireless system using phone, MP3, Notebook, etc..
- The more distance between the unit and the bluetooth device, the lower the sound quality becomes.
- Bluetooth connection will be disconnected when the unit is turned off or the bluetooth device gets far from the unit.
- When Bluetooth connection is disconnected, connect the bluetooth device to the unit again.
- When not connected the Bluetooth, "READY" appears on the display window.

Using Bluetooth App

! Note

Only Android OS is available to use "LG Bluetooth Remote" app with this unit.

About "LG Bluetooth Remote" App

"LG Bluetooth Remote" app brings a suite of new features to this unit.

To enjoy more features, you are recommended to download and install free "LG Bluetooth Remote" app.

Install "LG Bluetooth Remote" App onto Your Bluetooth Device

There are two ways to install "LG Bluetooth Remote" App onto Your Bluetooth Device.

Install "LG Bluetooth Remote" App through QR code

1. Install "LG Bluetooth Remote" app through QR code. Use the scanning software to scan the QR code.



2. Tap an icon for installation.
3. Tap an icon for downloading.

! Note

- Make sure that your Bluetooth device is connected to the Internet.
- Make sure that your Bluetooth device has a scanning software application. If you don't have one, download one from "Google Android Market (Google Play Store)".

Install “LG Bluetooth Remote” App through “Google Android Market (Google Play Store)”

1. Tap the “Google Android Market (Google Play Store)” icon.
2. In the search bar, type in the “LG Bluetooth Remote” and search it.
3. In the search result list, find and tap “LG Bluetooth Remote” to start downloading Bluetooth app.
4. Tap an icon for installation.
5. Tap an icon for downloading.

! Note

- Make sure that your Bluetooth device is connected to the Internet.
- Make sure that your Bluetooth device is equipped with “Google Android Market (Google Play Store)”.

Activate Bluetooth with “LG Bluetooth Remote” App

“LG Bluetooth Remote” app helps to connect your bluetooth device to this unit.

1. Tap “LG Bluetooth Remote” app icon on the home screen to open “LG Bluetooth Remote” app, and go to the main menu.
2. Tap [Setting] and select the unit you want.
3. If you want to get more information to operate, tap [Setting] and [Help].

! Note

- “LG Bluetooth Remote” app will be available in the software version as follow;
 - Android O/S : Ver 2.3.3 (or later)
- This unit does not support the multi-pairing. If this unit is already connected with other Bluetooth device, disconnect that device and then try again.
- If you use “LG Bluetooth Remote” app for operation, there would be some differences between “LG Bluetooth Remote” app and the supplied remote control. Use the supplied remote control as necessary.
- Depending on the Bluetooth device, “LG Bluetooth Remote” app may not work.
- After connection of “LG Bluetooth Remote” app, music may be output from your device. In this case, try connecting procedure again.
- If you operate the other applications or change the settings on your Bluetooth device while using “LG Bluetooth Remote” app, “LG Bluetooth Remote” app may operate abnormally.
- When “LG Bluetooth Remote” app operate abnormally, check your Bluetooth device and the connection of “LG Bluetooth Remote” app and then try to connect again.
- Depending on the smart phone’s operating system, you have some differences for “LG Bluetooth Remote” operation.
- If you select Bluetooth function after “LG Bluetooth Remote” app has been disconnected, this unit and your Bluetooth device will be paired automatically but you cannot control this unit by “LG Bluetooth Remote” app. To use “LG Bluetooth Remote” app, reconnect the app.
- Even though Bluetooth connection will be disconnected, you can use “LG Bluetooth Remote” app when you change the function to the others except LG TV function.

Sound adjustment

Setting sound effect

This system has a number of pre-set surround sound fields. You can select a desired sound mode by using **SOUND EFFECT**.

The displayed items for the equalizer may be different depending on sound sources and effects.

On Display	Description
STD (Standard)	You can enjoy the sound without equalizer effect.
NEWS	This program make voice sound clear, improving the quality of voice sound.
MUSIC	You can enjoy comfortable and natural sound.
CINEMA	You can enjoy more immersive and cinematic surround sound.
SPORTS	You can enjoy more dynamic sound.
BASS	The Bass is Bass Blast. During playback, reinforce the treble, bass and surround sound effect.

! Note

- In some of surround modes, some speakers, there's no sound or low sound. It depends on the mode of surround and the source of audio, it is not defective.
- You may need to reset the surround mode, after switching the input, sometimes even after the sound file changed.
- Because this unit has an exclusive sound effect for FLAC file, the sound effect is fixed while playing FLAC file.

Adjust volume level automatically

This unit supports Auto volume function that automatically adjusts the volume level.

When the output sound is too loud or too low, press **AUTO VOLUME** on the remote control. So you can enjoy the sound with appropriate levels.

To cancel this function, press the button again.

Adjust the woofer level settings

You can adjust the sound level of woofer from -40 dB to 6 dB.

1. Press **WOOFER LEVEL**.
2. Press **VOL +/—** to adjust the sound level of the woofer.

Controlling a TV with the supplied remote control

You can control your TV using the buttons below.

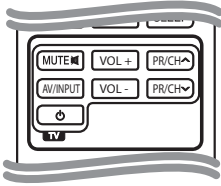

Button	Operation
MUTE	Turn the TV's volume on or off.
AV/INPUT	Switch the TV's input source between the TV and other input sources.
(TV Power)	Turn the TV on or off.
VOL	Adjust the volume of the TV.
PR/CH	Scan up or down through memorized channels.

Note

- Depending on the TV being connected, you may not be able to control your TV using some of the buttons.
- The remote control of the unit performs basic operation of your TV. Please use the TV's remote control to enjoy advanced operation of your TV.

Setting up the remote to control your TV

You can operate your TV with the supplied remote control.

If your TV is listed in the table below, set the appropriate manufacturer code.

- While holding down (TV Power) button, and press the manufacturer code for your TV with the numerical buttons (see the table below).

Manufacturer	Code Number
LG	1(Default), 2
Zenith	1, 3, 4
GoldStar	1, 2
Samsung	6, 7
Sony	8, 9
Hitachi	4

- Release the (TV Power) button to complete setting.

Depending on your TV, some or all buttons may not function on the TV, even after entering the correct manufacturer code. When you replace the batteries of the remote, the code number you have set may be reset to the default setting. Set the appropriate code number again.

Troubleshooting

PROBLEM	CAUSE & CORRECTION
The unit does not work properly.	<ul style="list-style-type: none"> • Turn off the power of this unit and the connected external device (TV, Woofer, DVD-player, Amplifier, etc.) and turn it on again. • Disconnect the power cord of this unit and the connected external device (TV, Woofer, DVD-player, Amplifier, etc.) and then try connecting again.
No Power	<ul style="list-style-type: none"> • The power cord is unplugged. Plug in the power cord. • Check the condition by operating other electronic devices.
No sound	<ul style="list-style-type: none"> • Incorrect input source is selected. Check the input source and select the correct input source. • The mute function is activated. Press MUTE or adjust the volume level to cancel the mute function. • When you are using connection with a external device (set top box, Bluetooth device etc.), adjust volume level of the device.
No woofer sound	<ul style="list-style-type: none"> • The power cord of the subwoofer is not connected. Plug the power cord into the wall outlet securely. • Pairing between the unit and the subwoofer gets disconnected. Connect the unit and the subwoofer. (Refer to the page 12.)
No display	<ul style="list-style-type: none"> • The DISPLAY OFF function is activated. Press SLEEP repeatedly to cancel the function. (Refer to the page 18.)
The remote control does not work properly.	<ul style="list-style-type: none"> • The remote control is too far from the unit. Operate the remote control within about 7 m. • There is an obstacle in the path of the remote control and the unit. Remove the obstacle. • The batteries in the remote control is exhausted. Replace the batteries with new one.
The AUTO POWER function does not work.	<ul style="list-style-type: none"> • Check connection of the external device such as TV, DVD/Blu-Ray player or Bluetooth device. • Depending on the connected device, this function may not operate.
LG Sound Sync does not work.	<ul style="list-style-type: none"> • Check whether your LG TV supports LG Sound Sync. • Check connection of LG Sound Sync (Optical or wireless). • Check sound setting of your TV and this unit.

PROBLEM	CAUSE & CORRECTION
When you feel the output sound of the unit is low.	<p>Check the details below and adjust the unit according to them.</p> <ul style="list-style-type: none">• Switch [ON] state of DRC function to [OFF] by using remote controller.• With the sound bar connected with TV, change the AUDIO DIGITAL OUT setting on TV Setup Menu from [PCM] to [AUTO] or [BITSTREAM].• With the sound bar connected with Player, change the AUDIO DIGITAL OUT setting on Player Setup Menu from [PCM] to [PRIMARY PASS-THROUGH] or [BITSTREAM].• Change Audio DRC setting on Player setup menu to [OFF] state.

Trademarks and licenses



Manufactured under license from Dolby Laboratories. Dolby and the double-D symbol are trademarks of Dolby Laboratories.



For DTS patents, see <http://patents.dts.com>. Manufactured under license from DTS Licensing Limited. DTS, the Symbol, & DTS and the Symbol together are registered trademarks, and DTS 2.0 Channel is a trademark of DTS, Inc. © DTS, Inc. All Rights Reserved.



Bluetooth® wireless technology is a system which allows radio contact between electronic.

Connecting individual devices under **Bluetooth**® wireless technology does not incur any charges. A mobile phone with **Bluetooth**® wireless technology can be operated via the Cascade if the connection was made via **Bluetooth**® wireless technology.

The **Bluetooth**® word mark and logos are owned by the **Bluetooth**® SIG, Inc. and any use of such marks by LG Electronics is under license.

Other trademarks and trade names are those of their respective owners.

Specifications

General (NB3540)	
AC adapter requirements	Refer to the main label on the unit.
Power consumption	Refer to the main label on the unit.
Dimensions (W x H x D)	(770 x 35 x 75) mm
Net Weight (Approx.)	1.3 kg
Operating temperature	5 °C to 35 °C (41 °F to 95 °F)
Operating humidity	5 % to 90 %

Input/Output	
OPT. IN	3 V (p-p), Optical jack x 1
PORT. IN	0.5 Vrms (3.5 mm stereo jack) x 1
Available Digital Input Audio Sampling Frequency	32 kHz, 44.1 kHz, 48 kHz, 96 kHz

USB	
Version	1.1
Bus Power Supply	5 V  500 mA

Amplifier	
Total	320 W
Front	80 W x 2 (4 Ω at 1 kHz)
Subwoofer	160 W (3 Ω at 80 Hz)
THD	10 %

Wireless subwoofer (S34A2-D)	
Power requirements	Refer to the main label on the subwoofer.
Power consumption	Refer to the main label on the subwoofer.
Type	1 Way 1 Speaker
Impedance	3 Ω
Rated Input Power	160 W
Max. Input Power	320 W
Dimensions (W x H x D)	(170 x 360 x 316) mm
Net Weight (Approx.)	5.55 kg

- Designs and specifications are subject to change without prior notice.

Maintenance

Handling the unit

When shipping the unit

Please save the original shipping carton and packing materials. If you need to ship the unit, for maximum protection, re-pack the unit as it was originally packed at the factory.

Keeping the exterior surfaces clean

- Do not use volatile liquids such as insecticide spray near the unit.
- Wiping with strong pressure may damage the surface.
- Do not leave rubber or plastic products in contact with the unit for a long period of time.

Cleaning the unit

To clean the player, use a soft, dry cloth. If the surfaces are extremely dirty, use a soft cloth lightly moistened with a mild detergent solution. Do not use strong solvents such as alcohol, benzine, or thinner, as these might damage the surface of the unit.

