



OWNER'S MANUAL

SXS

REFRIGERATOR

Please read this owner's manual thoroughly before operating and keep it handy for reference at all times.



MFL67653438

www.lg.com

Table of contents

Introduction	Entry	3
	Basic safety precautions	3
	Identification of parts	13
Installation	Where to install	14
	Door removal	15
	Door replacement	16
	Feed water pipe installation	16
	Height adjustment	18
Operation	Starting	19
	Adjusting the temperatures and functions	19
	Adjusting the temperatures and display	20
	Setting the functions	21
	Hygiene Fresh*	22
	Operating the dispenser	23
	Refreshment center (Applicable to some models only)	27
	Shelf	28
	Dairy corner	28
	Egg box	29
	Deodorizer	29
	Freezer/Fridge basket	29
	Fresh compartment	30
Suggestion on food storage	Location of foods	31
	Storing foods	32
Care and maintenance	General information	33
	Cleaning	33
	Smart Diagnosis	34
	Trouble shooting	35
	Disposal of the old appliance	38
	It is normal...	39



▪ This product is exclusive use at 220V/50Hz.

▪ You should purchase transformer of more than 2.0KVA when you want to use it at the 110V area.

Entry

The model and serial numbers are found on the inner case or Right side of refrigerator compartment of this unit. These numbers are unique to this unit and not available to others. You should record requested information here and retain this guide as a permanent record of your purchase. Staple your receipt here.

Date of purchase	:	_____
Dealer purchased from	:	_____
Dealer address	:	_____
Dealer phone no.	:	_____
Model no.	:	_____
Serial no.	:	_____

Basic safety precautions

This guide contains many important safety messages. Always read and obey all safety messages.

 This is the safety alert symbol. It alerts you to safety messages that inform you of hazards that can kill or hurt you or others or cause damage to the product. All safety messages will be preceded by the safety alert symbol and the hazard signal word DANGER, WARNING, or CAUTION. These words mean:

 **DANGER** You will be killed or seriously injured if you don't follow instructions.

 **WARNING** You can be killed or seriously injured if you don't follow instructions.

 **CAUTION** Indicates an imminently hazardous situation which, if not avoided, may result in minor or moderate injury, or product damage only.

All safety messages will identify the hazard, tell you how to reduce the chance of injury, and tell you what can happen if the instructions are not followed.

WARNING

To reduce the risk of fire, electric shock, or injury to persons when using your product, basic safety precautions should be followed, including the following. Read all instructions before using this appliance.

1. When connecting the power

The dedicated outlet should be used.

- Using several devices at one outlet may cause fire.
- The electric leakage breaker may damage food and the dispenser may be leaked.



Do not allow the power plug to face upward or to be squeezed at the back of the refrigerator.

Water may be flown into or the plug may be damaged, which causes fire or electric shock.

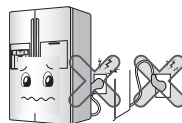

Prevent the power cord from being squeezed or imprinted if the refrigerator is pushed in after the power plug is extracted during the installation.

When moving your appliance away from the wall, be careful not to roll over the power cord or to damage it in any way.

It becomes the cause of fire or electric shock.

Do not allow the power cord bent or pressed by the heavy object to be damaged.

It may damage the power cord to cause fire or electric shock.



Do not extend or modify the length of the power plug.

It causes electric shock or fire by the electric damage of the power cord or others.

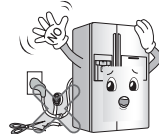

Unplug the power plug when cleaning, handling or replacing the interior lamp of the refrigerator.

- It may cause electric shock or injury.
- When replacing the interior lamp of the refrigerator, make sure that the rubber ring for preventing the electric spark within the socket is not taken off.



Do not pull out the cord or touch the power plug with wet hands.

It may cause electric shock or injury.



Remove water or dust from the power plug and insert it with the ends of the pins securely connected.

Dust, water or unstable connection may fire or electric shock.

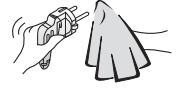

Unplug the power cord from the power outlet for cleaning or other requirements.

It may cause electric shock or injury.

Pull out the power plug not by grasping the cord but the plug of its end.

It may cause electric shock or short circuit to fire.



Make sure of grounding.

Consult a qualified electrician or service person if the grounding instructions are not completely understood, or if you have doubts on whether the appliance is properly grounded.

The incorrect grounding may cause breakdown and electric shock.

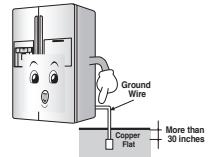

Be sure to use grounded exclusive proper voltage consent for the power plug.

Be sure to use grounded extension consents when extension consents are used.

It becomes the cause of fire.

When the power cord or the power plug is damaged or the holes of the outlet are loosed, do not use them and have it replaced immediately by the manufacturer or its service agent.

It may cause electric shock or short circuit to make fire.

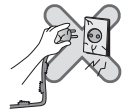

Wait for 5 minutes or longer when reconnecting the plug.

It may cause the operation of the freezer to fail.



If the supply cord is damaged, it must be replaced by the manufacturer or its service agent or a similarly qualified person in order to avoid a hazard.

2. When using the refrigerator

Do not place the heavy object or the dangerous object (container with liquid) on the refrigerator.

It may be dropped to cause injury, fire or electric shock when opening or closing the door.



Do not install the refrigerator in the wet place or the place which water or rain splashes.

Deterioration of insulation of electric parts may cause electric leakage.



Do not cling to the door or the shelves of the door or the home bar of the freezer or the cool chamber.

It may make the refrigerator fallen down or damage the hands. Especially, do not allow the children to do the above.

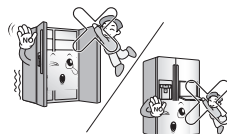

When water entered to electric parts inside the product, pull out the power plug, and contact the service center.

It may cause electric shock or fire.

Prevent children from entering the product.

It may endanger the life of a child if the child enters the refrigerator.



Opening and closing the door of the refrigerator vigorously may cause the stored food in the refrigerator basket to fall by shock and hurt the foot, so take precautions.

Do not use or store inflammable materials ether, benzene, alcohol, medicine, LP gas, spray or cosmetics near or in the refrigerator.

It may cause explosion or fire.

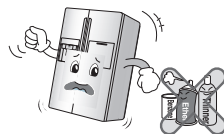

Do not use drier to dry the inside, nor light a candle to remove odor.

It may cause explosion or fire.

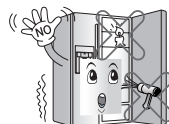

Do not store the medicine or the academic materials at the refrigerator.

When the material with the strict temperature control is stored, it may be deteriorated or it may make an unexpected reaction to cause any risk.

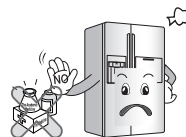

Do not use the combustible spray near the refrigerator.

It may cause fire.

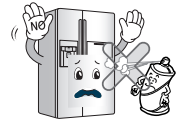

Install in places away from the fire such as the place where flammable gas is leaked.

It may cause fire.



Do not place flower vase, cup, cosmetics, medicine or any container with water on the refrigerator.

It may cause fire, electric shock or injury by dropping down.



In case of thunder and lightning, or not in use for a long period of time, detach the power plug.

There is a danger of electric shock or fire.

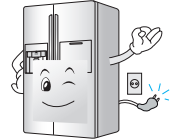

Use the submerged refrigerator after checking it.

It may cause electric shock or fire.

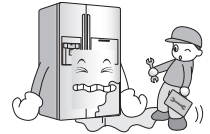

When gas is leaked, do not touch the refrigerator or the outlet and ventilate the room immediately.

- The explosion by spark may cause fire or burn.
- Because this refrigerator uses natural gas (isobutene, R600a) as the environment-friendly refrigerant, even a small amount (70~90g) is combustible. When the gas is leaked by the severe damage during delivering, installing or using the refrigerator, any spark may cause fire or burn.

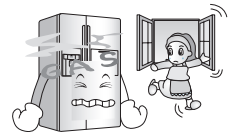

Do not move refrigerator while the refrigerator is operating.

Compressor may occur a temporary rattling noise. (This is normal and will not impact on the performance or the life of the compressor. The rattling will stop after the refrigerator comes to a rest.)

Do not spray water at the outside or the inside of the refrigerator or do not clean it with benzene or thinner.

Deterioration of insulation of electric parts may cause electric shock or fire.



When any strange smell or smoke is detected from the refrigerator, disconnect the power plug immediately and contact to the service center.

It may cause fire.

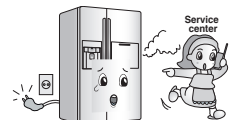

Do not allow any person except the qualified engineer to disassemble, repair or alter the refrigerator.

It may cause injury, electric shock or fire.

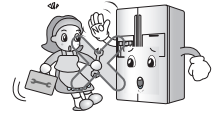

Do not use the refrigerator for non-domestic purpose (storing medicine or testing material, using at the ship, etc.).

It may cause an unexpected risk such as fire, electric shock, deterioration of stored material or chemical reaction.

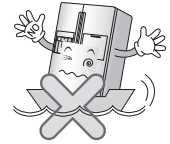

Be careful of the door falling down during disassembly and assembly of the door.

Do not insert refrigerator shelf upside down.

The shelf may fall down and cause injury.

When disposing the refrigerator, remove the packing materials from the door or take off the doors but leave the shelves in place so that children may not easily climb inside.

It may cause to lock out the child.



This appliance is not intended for use by persons (including children) with reduced physical, sensory or mental capabilities, or lack of experience and knowledge, unless they have been given supervision or instruction concerning use of the appliance by a person responsible for their safety.

Do not store too many water bottles or containers in the door basket.

It could damage the basket or cause a hand injury against the surrounding structure because of an excessive force applied when taking out a water bottle or a container from the basket.

Children should be supervised to ensure that they do not play with the appliance.

Install the refrigerator on the solid and level floor.

Installing it on the unstable place may cause death by falling down the refrigerator when opening or closing the door.



Do not insert the hands or the metal stick into the exit of cool air, the cover, the bottom of the refrigerator, the heatproof grill (exhaust hole) at the backside.

It may cause electric shock or injury.

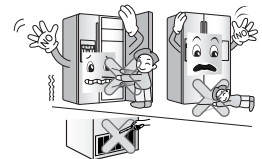

The appliance must be positioned so that the plug accessible after installation.

Do not touch food or containers at the freezer with wet hands.

Electric Shock Hazard. Disconnect electrical supply to refrigerator before installing. Failure to do so could result in death or serious injury.

If your access door is too narrow for the refrigerator to pass through, remove the refrigerator door and pass the refrigerator laterally.

Do not insert your hands in to the Icemaker in operation. It may cause to injure you.

Always disassemble the fresh compartment using two hands.

You can be injured from the weight of the compartment when filled with food.

When disassembling/reassembling the fresh compartment of the fridge, open the refrigerator door fully.

You can disassemble/reassemble the freezer drawer in the same method.

Always disassemble the fresh compartment using two hands. (You can be injured from the weight of the compartment when filled with food.)

When disassembling/reassembling the fresh compartment or V Fresh compartment of the fridge, open the refrigerator door fully.

Keep ventilation openings, in the appliance enclosure or in the built-in structure, clear of obstruction.

Do not use mechanical devices or other means to accelerate the defrosting process, other than those recommended by the manufacturer.

Do not damage the refrigerant circuit.

Do not use electrical appliances inside the food storage compartments of the appliance, unless they are of the type recommended by the manufacturer.

The refrigerant and insulation blowing gas used in the appliance require special disposal procedures. When disposal, please consult with service agent or a similarly qualified person.



This appliance contains a small amount of isobutane refrigerant (R600a), natural gas with high environmental compatibility, but it is also combustible. When transporting and installing the appliance, care should be taken to ensure that no parts of the refrigerating circuit are damaged. Refrigerant squirting out of the pipes could ignite or cause an eye injury. If a leak is detected, avoid any naked flames or potential sources of ignition and air the room in which the appliance is standing for several minutes.

In order to avoid the creation of a flammable gas air mixture if a leak in the refrigerating circuit occurs, the size of the room in which the appliance may be sited depends on the amount of refrigerant used. The room must be 1m² in size for every 8g of R600a refrigerant inside the appliance. The amount of refrigerant in your particular appliance is shown on the identification plate inside the appliance. Never start up an appliance showing any signs of damage. If in doubt, consult your dealer.

CAUTION

**Violating this direction may cause injury or damage house or furniture.
Always be careful, please.**

**Do not insert the hands into the ice bucket or the ice dispenser.
(only for the model with the dispenser).**

Operating the ice maker may cause injury.



Do not touch food or containers at the freezer with wet hands.

It may cause frostbite.

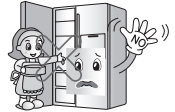

Do not put ice in thin crystal cup or ceramic ware.

It may break cup or ceramic ware to cause injury.



**When the electricity is off, remove ice from the ice bucket
(only for the model with the dispenser).**

The long-time power failure may thaw ice to damage the floor.
When the long-time power failure is expected, remove ice from
the ice bucket.

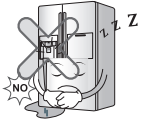

**Supply the automatic ice maker with drinkable water only
(only for the model with the dispenser).**

Otherwise, it may cause any risk.

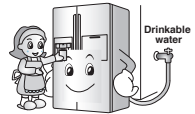

**Do not remove the cover of the automatic ice maker.
(Only for the models with automatic ice maker)**

The operation mechanic parts of the ice maker may hurt people.

Do not place the food in disorder inside the refrigerator.

The food may fall during opening and closing the door of the refrigerator and hurt
people.

Do not put bottle in the freezer.

It may freeze the contents to break the bottle to cause injury.



Do not insert the hands into the bottom of the refrigerator.

The iron plate of the bottom may cause injury.



Do not tilt the product while moving the product.

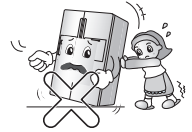

Carry the refrigerator with the handle bar at the bottom of the front and the top of the rear.

Otherwise, your hands may be slipped to cause injury. Because the product is heavy, carrying it alone may hurt people or accidents may occur.

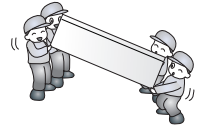

Because opening or closing the door or the handle bar of the refrigerator may cause injury to the person around it, be careful, please.

Opening or closing the door may cause feet or hands to be caught in the chink in door or the child to be get hurt by the corner.

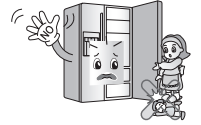

Do not put any living animal in the refrigerator.

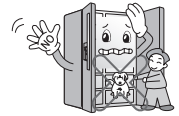

If refrigerator is moved in zigzag direction, it may damage the floor. Please move it only in a straight line direction.

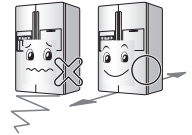

When the user switches to AUTO or POWER mode, the LED near the filter will be turned on. Open the refrigerator door to check whether the LED near the filter is turned on. Do not insert the finger or any other alien object inside the fan. It can cause an injury or malfunction.

Do not wash the Hygiene Fresh+ as it can deteriorate the performance.

If the user continues to use the Hygiene Fresh+ past the time to replace, the antibacterial and deodorizing performance can be deteriorated.

This filter may not be effective for all bacteria or virus types.

This is effective for the bacteria growing on inside the refrigerator and not on the food.

Throw away the ice (about 20 pieces) and water (about 7 glasses) first made after refrigerator installation.

The first ice and water may include particles or odor from the feed water pipe or feed water box. This is necessary in case that the refrigerator has not been used for a long time.

Keep children away from the dispenser.

Children may push switch incorrectly bad or damage lamps.

Be careful that food is not block the ice passage.

If foods are placed at the entrance of ice passage, ice may not be dispensed. The ice passage may also be covered with ice powder if splinter ice is used only. This time, remove the ice powder accumulated.

Never store beverage cans or other foods in ice storage bin for the purpose of rapid cooling.

Such actions may damage the automatic ice maker.

Never use thin crystal glass or crockery to collect ice.

Such glasses or containers may be broken.

Put ice first into a glass before filling water or other beverages.

Water may be splashed if ice is added to existing liquid in a glass.

Never touch a hand or other tools on ice outlet.

Touch may cause a part breakage or hand injury.

Never remove the ice maker cover.**Sometimes level the surface so that the ice storage bin is fully filled with ice.**

Ice is piled up just near the ice maker. So, such status may be considered, by the ice maker, that the ice storage bin is fully filled and ice making operation may stop.

If discolored ice is dispensed, immediately contact service center, stopping use.**Never use too narrow or deep glass.**

Ice may be jammed in ice passage and, thus, the refrigerator may be failed.

Keep the glass at a proper distance from ice outlet.

A glass too close to the outlet may hinder ice from coming out.

That's why you may have chilblains and they may be broken when their inner matters are frozen, causing personal injury.

You must check the O-RING, which is made by rubber and prevent electric spark.

Don't touch lamp, in case of light on the long time. Because it can be very hot.

To get best performance from the product.

Do not place foods too closely in front of the vents at the rear of the appliance as it can obstruct free air circulation in the refrigerator compartment.

Do not place carbonated or fizzy drinks in the freezer compartment.

When installing, servicing or cleaning behind the refrigerator, be sure to pull the unit straight out and push back straight in after finishing.

Do not store explosive substances such as aerosol cans with a flammable propellant in this appliance.

Identification of parts

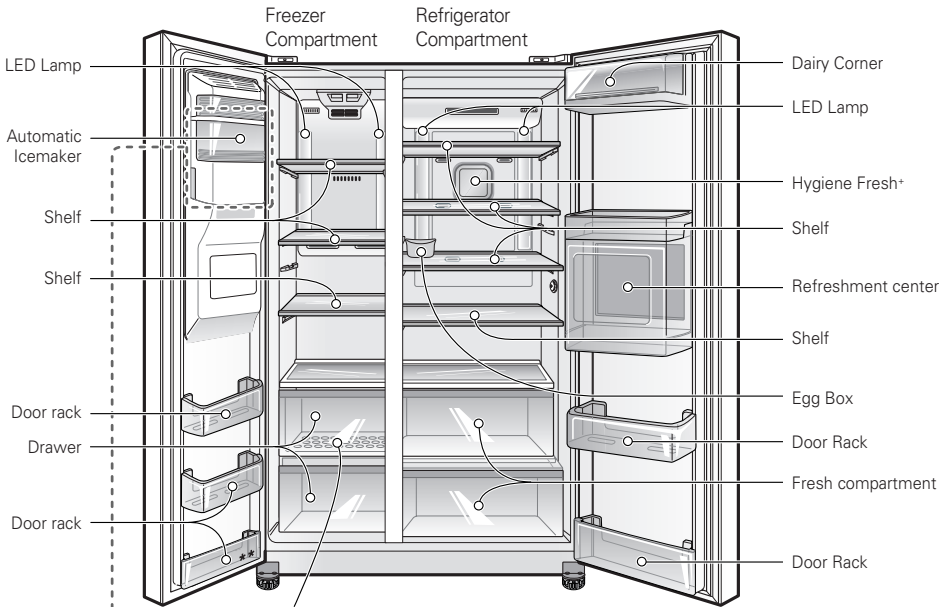

Shelf : When you remove freezer drawers, you can use this shelf to store foods. It does not affect a performance of fridge.

If your fridge has a shelf between freezer drawers,

1. You can remove freezer drawers for more space.
2. A designated storage volume is calculated with drawers removed.



Door Rack(Option): Use more space with door rack when you don't use Ice Maker.

NOTE

- Parts, features, and options vary by model. Your model may not include every option.

Usage of door rack

- Disassemble and empty the automatic icemaker.
- Turn off the ice maker(refer to Operating the dispenser).
- Assemble the Door rack with care.

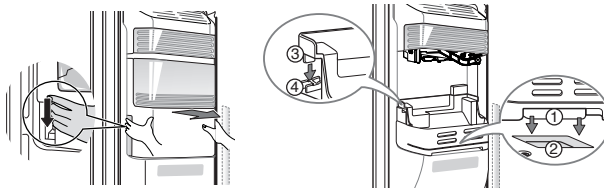

- ▶ Insert ① into bottom hole (②).
- ▶ Both hooks (③) should be assembled behind ④.
- ▶ Don't store any food easily fallen. It might fall to the floor when you open the door.

Select a good location**Where to Install**

1. Place your appliance where it is easy to use.
2. Avoid placing the unit near heat sources, direct sunlight or moisture.
3. To ensure proper air circulation around the fridge-freezer, please maintain sufficient space on both the sides as well as top and maintain at least 2 inches (5 cm) from the rear wall.
4. To avoid vibrations, the appliance must be leveled.
5. Don't install the appliance below 5°C. It may cause affect the performance.

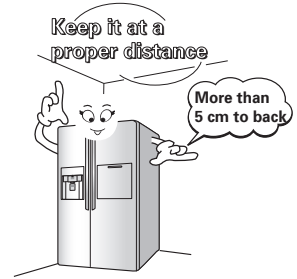
**Appliance usage range**

This appliance is intended to be used in household and similar applications such as

- staff kitchen areas in shops, offices and other working environments;
- farm houses and by clients in hotels, motels and other residential type environments;
- bed and breakfast type environments;
- catering and similar non-retail applications.

WARNING

Door removal

Electric Shock Hazard

Disconnect electrical supply to refrigerator before installing. Failure to do so could result in death or serious injury.

If your access door is too narrow for the refrigerator to pass through, remove the refrigerator door and pass the refrigerator laterally.

Remove the freezer compartment door

- 1) Removing the hinge cover by loosening the screws. Separate all connection wires.
- 2) Remove the keeper by rotating it counter clockwise (①) and then lifting the upper hinge up (②).

NOTE

- When removing the upper hinge, be careful that the door does not fall forwards.

- 3) Remove the freezer compartment door by lifting it upward. This time, the door should be lifted enough for the feed water pipe tube to be completely pulled out.

NOTE

- Move the refrigerator compartment door passing through the access door and lay it down, but be careful not to damage the feed water pipe tube.

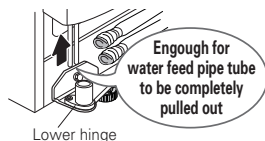
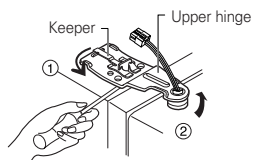
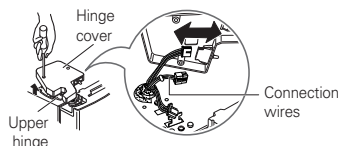
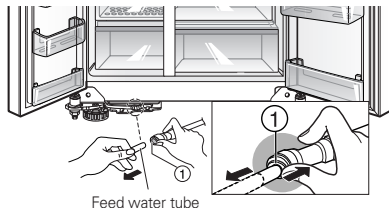

Remove the refrigerator door

- 1) Loosen the hinge cover screws and remove the cover. Remove connection wire.
- 2) Remove keeper by rotating it clockwise (①) and then remove the upper hinge by lifting it up (②).
- 3) Remove the refrigerator compartment door by lifting it up.

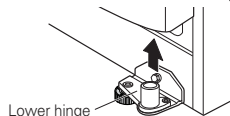
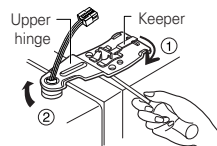

NOTE

- Do not remove the grease on the surface of gasket or hinge.

Pass the refrigerator

Pass the refrigerator laterally through the access door as shown in the right figure.

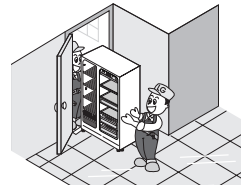
**Door replacement**

Mount them in the reverse sequence of removal after they pass through the access door.

Feed water pipe installation**Before installation**

- Automatic ice maker operation needs water pressure of 147~834 kPa (1.5~8.5 kgf/cm²) (That is, an instant paper cup (180 cc) will be fully filled within 3 sec.).
- If water pressure does not reach the rating 147 kPa (1.5 kgf/cm²) or below, it is necessary to purchase a separate pressure pump for normal automatic icing and cool water feed.
- Keep the total length of the feed water pipe tube within 8 m and be careful for the tube not be bent. If the tube is 8 m or longer it may cause trouble in water feed owing to the drain water pressure.
- Install the feed water pipe tube at a place free from heat.
- Connect to potable water supply only.
- Refer to instructions with water filter kit for installation.

WARNING

IMPORTANT : Use only new hose-sets supplied with the appliance and do not reuse old hose-sets.

Handle removal

To move the refrigerator through a house door, it may be necessary to remove the refrigerator door handles.

NOTE

- Handle appearance may vary from illustrations on this page.

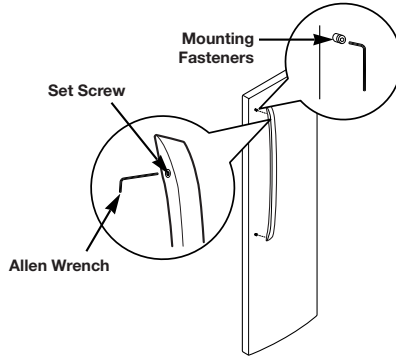

Loosen the set screws with a 2.5 mm (3/32") Allen wrench and remove the handle.

NOTE

- If the handle mounting fasteners need to be tightened or removed, use a 1/4" Allen wrench.

**Handle
reinstallation**

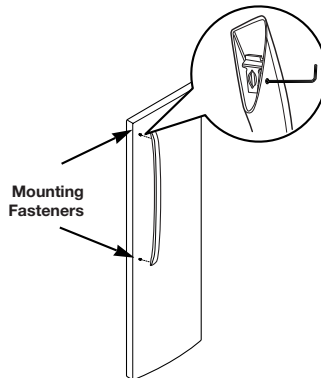

Place the handle on the door by aligning handle footprints to fit mounting fasteners and tighten the set screws with a 2.5 mm (3/32") Allen wrench.

NOTE

- If the handle mounting fasteners need to be tightened or removed use a 1/4" Allen wrench.

Height adjustment

When the floor is not leveled

- When the height of the door may not be leveled when the floor is not leveled.

► **When the freezer door is lower – ①**

Use the spanner to turn the nut of the height adjustment screw on the left to the counterclockwise direction to level the door.

Adjust the height of the door, insert the E ring. A maximum of three rings (Only Freezer). 2 E rings are enveloped with owners manual.

► **When the fridge door is lower – ②**

Use the spanner to turn the nut of the height adjustment screw on the right to the clockwise direction to level the door.

Height difference



When using the spanner

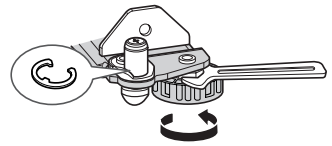

When the fridge door is lower than the freezer door

► **When the fridge door is lower than the freezer door while using the refrigerator, level the doors.**

1. Use the ③ tool for adjustment on the wide side to turn nut ① (↻) in the clockwise direction to loosen the keeper nut.
2. Use the ③ tool for adjustment on the narrow side to turn the adjustment hinge pin ② in (↻) clockwise direction or (↻) counterclockwise direction to adjust the height of the fridge and freezer doors.

Height difference

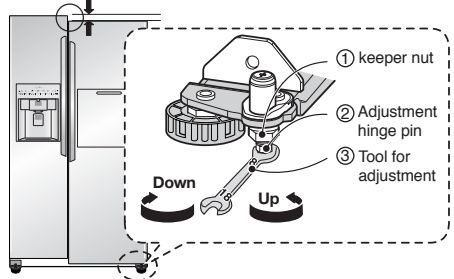

3. After aligning the height of the door, turn the keeper nut in counterclockwise direction tightly.

CAUTION

Do not force too hard to level the height. The hinge pin can be pulled out. (Adjustable range of height is a maximum of 2" (5 cm))

After leveling the door height

The refrigerator doors will close smoothly by heightening the front side by adjusting the height adjusting screw. If the doors do not close correctly, performance may be affected.

Next

1. Wipe off all dust accumulated during shipping and clean your appliance thoroughly.
2. Install accessories such as the ice cube box, cover evaporating tray, etc., in their proper places. They are packed together to prevent possible damage during shipping.
3. Connect the power supply cord (or plug) to the outlet. Don't double up with other appliances on the same outlet.

Starting

When your refrigerator is first installed, allow it to stabilize at normal operating temperatures for 2-3 hours prior to filling it with fresh or frozen foods. If operation is interrupted, wait 5 minutes before restarting.

Adjusting the temperatures and functions

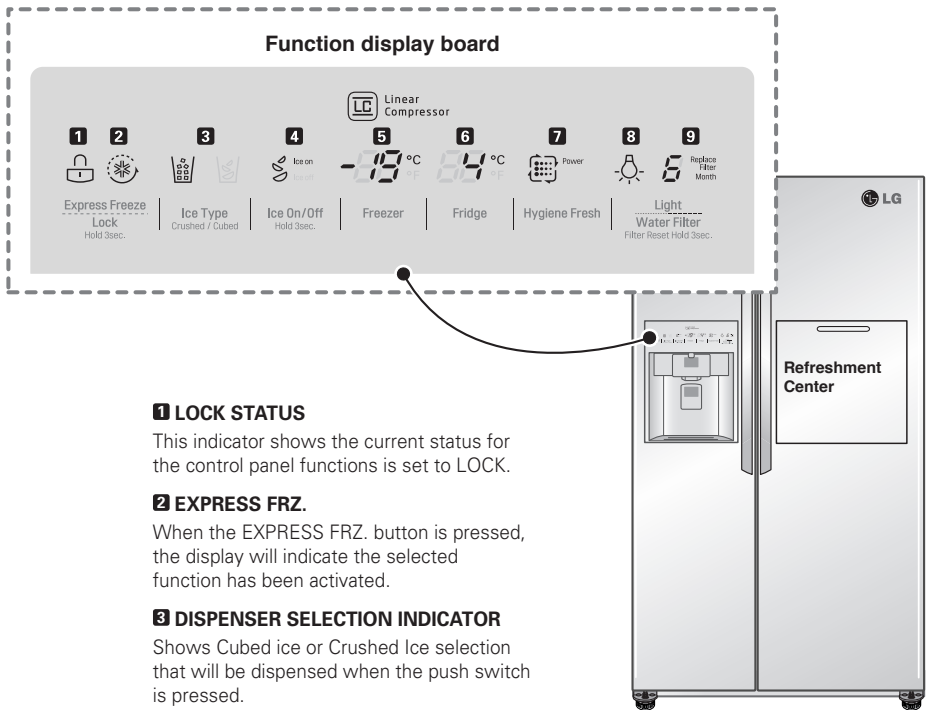

1 LOCK STATUS

This indicator shows the current status for the control panel functions is set to LOCK.

2 EXPRESS FRZ.

When the EXPRESS FRZ. button is pressed, the display will indicate the selected function has been activated.

3 DISPENSER SELECTION INDICATOR

Shows Cubed ice or Crushed Ice selection that will be dispensed when the push switch is pressed.

4 ICE ON/OFF INDICATOR

Shows Icemaker's "ON" or "off" selection that will be operated when "Ice on" is lighted.

5 FREEZER TEMPERATURE

Indicates the set temperature of the freezer compartment in Celsius or Fahrenheit.

6 REFRIGERATOR TEMPERATURE

Indicates the set temperature of the refrigerator compartment in Celsius or Fahrenheit.

7 HYGIENE FILTER INDICATOR

This indicator shows the current status for the HYGIENE Filter.

8 DISPENSER LIGHT INDICATOR

When the LIGHT button is pressed, the display will indicate the selected function: The dispenser light is on, this indicator will appear on the display panel.

9 WATER FILTER STATUS

This indicator shows the current status for the water filter. See Resetting the Filter Indicator.

Adjusting the temperatures and display

Adjust Freezer Temperature

To adjust the temperature in the freezer compartment, press the FREEZER button to cycle through the the range of available settings.

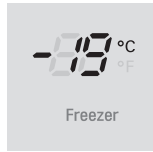

Adjust Refrigerator Temperature

To adjust the temperature in the refrigerator compartment, press the REFRIGERATOR button to cycle through the range of available settings.

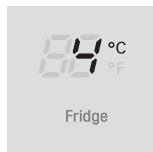

NOTE

- The actual inner temperature varies depending on the food status, since the indicated temperature setting is the target temperature and not the actual temperature within the refrigerator. Initially set the REFRIGERATOR CONTROL at 4 degrees C and the FREEZER CONTROL at -19 degrees C. Leave them at these setting for 24 hours (one day) to stabilize. Then adjust the compartment temperature as illustrated above.
- Temperature range of the Refrigerator Control : 1°C ~ 7°C
Temperature range of the Freezer Control : -14°C ~ -24°C

Setting the functions

Press the button for the desired function to view and select other settings.

Setting The Control panel Lock

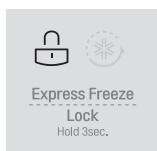

Press and hold the ALARM/LOCK button for three seconds to lock all of the control panel functions. Press and hold again for 3 seconds to unlock.

Activating EXPRESS FREEZING

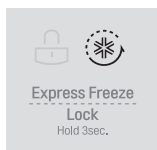

Press the EXPRESS FRZ. button once to activate the EXPRESS FREEZING function. The EXPRESS FRZ. icon on the display panel will illuminate when activated. The EXPRESS FREEZING function runs the freezer compartment at the coldest setting for a 24-hour period to increase icemaking by up to about 20%, and then turns off automatically.

NOTE

- Press the button again to cancel the EXPRESS FREEZING function.

Resetting The Filter Indicator

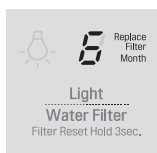

Press and hold the LIGHT/FILTER button for more than 3 seconds to reset the filter indicator after the water filter has been replaced.

NOTE

- It is recommended that you replace the filter when the water filter indicator light reaches 0 or whenever the water or ice cube taste deteriorates noticeably.

Connect the lines coming from the water pipes.

Connection lines entering into the refrigerator.

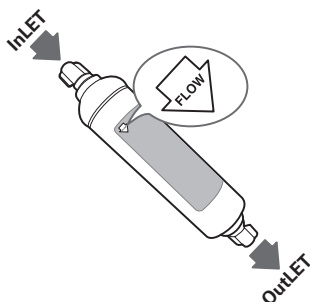

Hygiene Fresh⁺

Hygiene Fresh⁺

Hygiene Fresh⁺ provides the antibacterial function of removing bacteria as well as the deodorizer function of removing the odor within the refrigerator. The performance test of the Hygiene Fresh⁺ has been done and proved through a public certification organization (**Intertek**).

- It can be used semi-permanently.

CAUTION

- When the user switches to AUTO or POWER mode, the LED near the filter will be turned on. Open the refrigerator door to check whether the LED near the filter is turned on.

CAUTION

- Do not force to separate Hygiene Fresh⁺ cover. It may cause malfunction.
- This filter may not be effective for all bacteria types.
- This is effective for the bacteria growing on inside the refrigerator and not on the food.

Switch to use mode

To use the Hygiene Fresh⁺, press the Hygiene Fresh button on the display panel to switch to AUTO or POWER mode.
(Every time the user presses the button, the function of Hygiene Fresh⁺ will switch in the order of OFF → AUTO → POWER → OFF.)

Hygiene Fresh



Operating the dispenser

Setting The Ice ON/OFF Indicator.

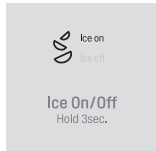

Press and hold ICE ON/OFF button for the more than 3 seconds to reset the ON/OFF indicator.

NOTE

- If you don't want to use the automatic icemaker, turn the icemaker switch to OFF. If you want to use automatic icemaker again, change the switch to ON.

Dispensing Crushed Ice

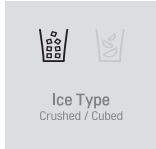

Press the ICE TYPE button to illuminate the Crushed Ice icon. Press the push ice switch with a glass or other container and crushed ice will be dispensed.

Dispensing Cubed Ice

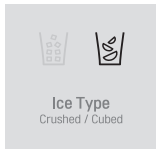

Press the ICE TYPE button to illuminate the Cubed Ice icon. Press the push switch with a glass or other container and cubed ice will be dispensed.

NOTE

- Hold the glass or other container in place for a couple of seconds after dispensing ice or water to catch the last few cubes or drops. The dispenser is designed to not operate while either refrigerator door is open.

Controlling The Dispenser Light

Press the LIGHT/FILTER button to turn the dispenser light on and off.

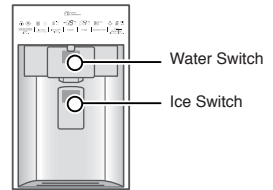

CAUTION

- When filling the container with a small opening, use it near the opening of the water or ice dispenser as close as possible.
- Do not dispense ice into crystal glasses or glass with low quality as crystal and glass with low quality might break.

	Incorrect Way	Correct Way
Water		
Ice		

After dispenser is used

The water collector has no self-drainage function, so it should be cleaned regularly. Remove the cover by pulling the front of the water collector cover and dry it with a cloth.

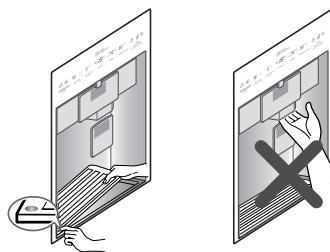

Automatic icemaker

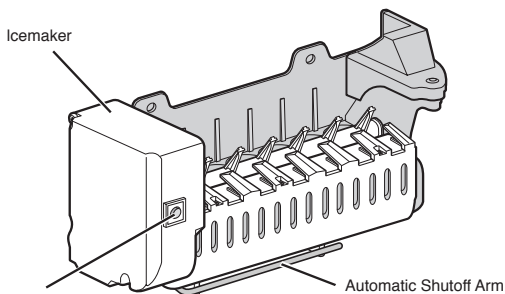

* This Button only
Must control by Service man.

- The automatic icemaker can automatically make 7 cubes at a time, 70~120 pieces per day. This quantity may vary by circumstance, including ambient temperature, door opening, freezer load. etc.
- Icemaking stops when the ice storage bin is full.

NOTE

- It is normal that a noise is produced when ice drops into the ice storage bin.

⚠ WARNING

- Do not insert your hands in to the Icemaker in operation. It may cause to injure you.

When ice maker does not operate smoothly

Ice is lumped together

- When ice is lumped together, take the ice lumps out of the ice storage bin, break them into small pieces, and then place them into the ice storage bin again.
- When the ice maker produces too small or lumped together ice, the amount of water supplied to the ice maker need to adjusted. Contact the service center.
- If ice is not used frequently, it may lump together.

Power failure

- Ice may drop into the freezer compartment. Take the ice storage bin out and discard all the ice then dry it and place it back. After the machine is powered again, crushed ice will be automatically selected.

The unit is newly installed

- It takes about 12 hours for a newly installed refrigerator to make ice in the freezer compartment.

The other functions

Door open warning

- 3 times of warning sounds at the interval of 30 seconds if a minute passes with the door of refrigerator and the hombar door opened or completely closed.
- Please contact with the local service center if warning continue to sound even after closing the door.

Diagnosis (failure detection) function

- Diagnosis function automatically detects failure when failure is found in product during the use of refrigerator.
- If failure occurs at product, it does not operate though pressing any button and normal indication is not done. In this case, do not turn power off but immediately contact with the local service center. A lot of time are need for service engineer to detect the failed part if turning it off.

How ice/cold water is supplied

Water is cooled while stored in the water tank, and then sent to the dispenser. Ice is made in the automatic ice maker and sent to the dispenser divided into crushed or cubed form ice.

NOTE

- It is normal that the water is not very cold at first. If you want colder water, add ice into the glass.

CAUTION

Throw away the ice (about 20 pieces) and water (about 7 glasses) first made after refrigerator installation.

The first ice and water may include particles or odor from the feed water pipe or feed water box. This is necessary in case that the refrigerator has not been used for a long time.

Keep children away from the dispenser.

Children may push switch incorrectly and damage lamps.

Be careful that food is not block the ice passage.

If foods are placed at the entrance of ice passage, ice may not be dispensed. The ice passage may also be covered with ice powder if splinter ice is used only. This time, remove the ice powder accumulated.

Never store beverage cans or other foods in ice storage bin for the purpose of rapid cooling.

Such actions may damage the automatic ice maker.

Never use thin crystal glass or crockery to collect ice.

Such glasses or containers may be broken.

Put ice first into a glass before filling water or other beverages.

Water may be splashed if ice is added to existing liquid in a glass.

Never touch a hand or other tools on ice outlet.

Touch may cause a part breakage or hand injury.

Never remove the ice maker cover.

Sometimes level the surface so that the ice storage bin is fully filled with ice.

Ice is piled up just near the ice maker. So, such status may be considered, by the ice maker, that the ice storage bin is fully filled and ice making operation may stop.

If discolored ice is dispensed, immediately contact service center, stopping use.

Never use too narrow or deep glass.

Ice may be jammed in ice passage and, thus, the refrigerator may be failed.

Keep the glass at a proper distance from ice outlet.

A glass too close to the outlet may hinder ice from coming out.

Refreshment center (Applicable to some models only)

How to use the Home Bar

1. Press the top central part of the Home Bar until you hear the "Click" sound.
 - You can save electricity because you do not have to open the refrigerator door.
 - Because the indoor lamps of the fridge and freezer are turned on even when you open only the Home Bar door, you can easily take out the food you want.
 - When closing the Home Bar, press until you hear the "Click" sound.
2. Open the door and use the door as the support board.
 - Put the beverage or food on the support board for convenience of use.

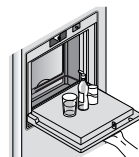
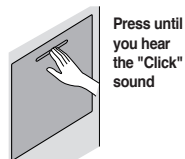

How to disassemble the fridge Home Bar cover

Pull up the Home Bar cover.

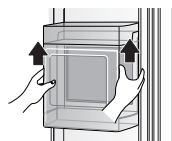

Precaution

1. Do not use the refrigerator with the internal Home Bar cover taken out.
 - If the cover is taken out, the Home Bar function cannot work.
2. Be careful not to press or damage the Home Bar support board.
 - If you lean or press the support board with your arm, it can be damaged.
 - Do not use the support board as a cutting board or use sharp tools on the support board to prevent any scratches.
 - When the support board is wet with alien fluid such as juice, it may not operate properly.
 - When the packing part is wet with alien fluid such as juice, periodically wipe the part.

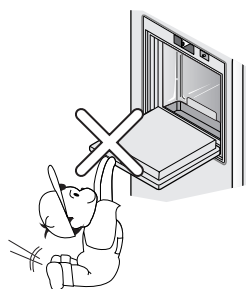
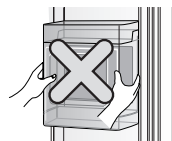

Shelf

How to use

You can store side dish or refrigerated food on the shelf with sufficient space in between the containers.



How to disassemble

1. Hold the front part of the shelf and pull it out until it gets blocked by the hooking part.

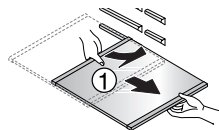

2. When you cannot pull out the shelf any more, lift it up slightly.

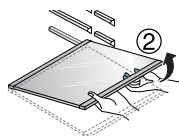

3. While holding the shelf slightly, tilt the shelf to pull it out.

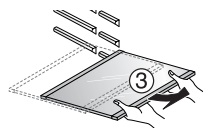

Dairy corner

How to use

You can store dairy goods such as butter, cheese etc.



How to disassemble

Hold the basket with both hands and pull it out by pulling it up (1).

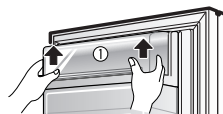

- ▶ If you close the refrigerator door with the dairy corner left open on the door side, the refrigerator door may not be closed properly. Therefore you must be careful.



Egg box

You can move the egg box to wherever you want.

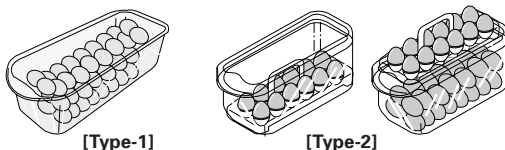

[Type-1]

[Type-2]

CAUTION

NOTE

- Never use the egg box as an ice storage bin. It can be broken.
- Never store the egg box in the freezer compartment or fresh compartment.

Deodorizer

How to use

With the deodorizer system, you can deodorize the refrigerator and the deodorizer can be reused.

How to disassemble

Unscrew the deodorizer cover using (+) driver, and then separate it while pulling the deodorizer cover.

► How to reuse the deodorizer

You can reuse the deodorizer continuously by drying it well with the hair dryer.

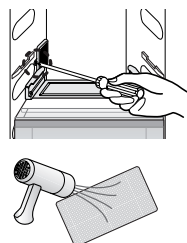

Freezer/Fridge basket

How to use

You can store small packaged frozen food (Freezer basket), small packaged refrigerated food or beverages (Fridge basket) such as milk, beer etc.

But, do not store ice cream or food to store for a long period of time (Freezer basket) etc.

How to disassemble

Hold the basket with both hands and slightly lift up the front part to pull it out.

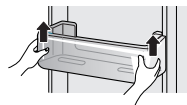

How to reassemble

Hold the basket with both hands and reassemble one side at a time by pushing it in.

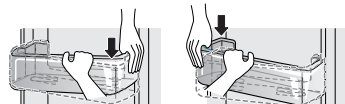

Two stars section ** (Applicable to some models only)

Freezer basket (two stars section)

- Two stars section means the space stored at -12°C~-18°C
- Freezer foods for short-terms storage.

Fresh compartment

How to use

You can store fruits or vegetables.

How to disassemble the upper fresh compartment

1. Hold the front handle of the fresh compartment and pull it out until it gets blocked by the hooking part.
 2. When you cannot pull out the fresh compartment any more, lift it up slightly to pull it out completely to the front side (outer side).
- * The fresh compartment can be reassembled in the reverse order.

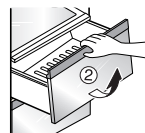
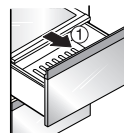

How to disassemble the lower fresh compartment

► When pulling out the lower fresh compartment

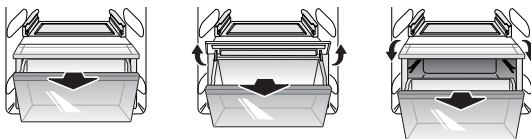

1. Hold the front handle of the fresh compartment and pull it forward.
2. When you cannot pull out the fresh compartment any more, lift it up slightly to pull it out to the front side.

► When inserting the lower fresh compartment



* When inserting the fresh compartment, always lift the cover up to push it in.

WARNING

- Always disassemble the fresh compartment using two hands. You can be injured from the weight of the compartment when filled with food.
- When disassembling/reassembling the fresh compartment of the fridge, open the refrigerator door fully.

How to disassemble upper/lower fresh compartment cover

Hold the cover with both hands and pull it out.

* When disassembling the cover, always disassemble the fresh compartment first.

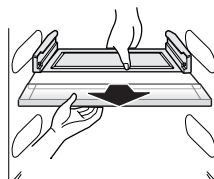

Location of foods

(Refer to identification of parts)

Freezer compartment shelf

Store various frozen foods such as meat, fish, ice cream, frozen snacks, etc..

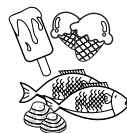

Freezer compartment door rack

- Store small packed frozen food.
- Temperature is likely to increase as door opens. So, do not store long-term food such ice cream, etc..



Freezer compartment drawer

- Store meat, fish, chicken, etc.. after wrapping them with thin foil.
- Store dry.



Dairy corner

Store milk products such as butter, cheese, etc..



Egg box

Place this egg box in the proper location.



Refreshment center

Store foods of frequent use such as beverage, etc..



Refrigerator compartment shelf

Store side dishes or other foods at a proper distance.

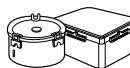

Refrigerator compartment door rack

Store small packed food or beverages such as milk, juice, beer, etc..



Vegetable drawer

Store vegetables or fruits.



Storing foods

- Store fresh food in the refrigerator compartment. How food is frozen and thawed is an important factor in maintaining its freshness and flavor.
- Do not store food which goes bad easily at low temperatures, such as bananas, and melons.
- Allow hot food to cool prior to storing, placing hot food in the refrigerator could spoil other food, and lead to higher energy consumption.
- When storing the food, cover it with vinyl wrap or store in a container with a lid. This prevents moisture from evaporating, and helps food to keep its taste and nutrients.
- Do not block air vents with food. Smooth circulation of chilled air keeps refrigerator temperatures even.
- Do not open the door frequently. Opening the door lets warm air enter the refrigerator, and cause temperatures to rise.
- Never keep too much food in door rack because they may push against by inner racks so that the door cannot be fully closed.

Freezer compartment

- Do not store bottles in the freezer compartment - they may break when frozen.
- Do not refreeze food that has been thawed. This causes loss of taste and nutrient.
- When storing frozen food like ice cream for a long period, place it on the freezer shelf, not in the door rack.
- Do not touch the cold foods or containers- especially made of metallic -, with wet hands and place glass products in the freezer compartment.

CAUTION

- That's why you may have chilblains and they may be broken when their inner matters are frozen, causing personal injury.

Refrigerator compartment

- Do not put the wet food on the top shelf of the cooling room. It may be frozen by getting the cool air directly.
- Always clean food prior to refrigeration. Vegetables and fruits should be washed and wiped, and packed food should be wiped, to prevent adjacent food from spoiling.
- When storing eggs in their storage rack or box, ensure that they are fresh, and always store them in an upright position, which keeps them fresh longer.

NOTE

- If you keep the refrigerator in a hot and humid place, frequent opening of the door or storing a lot of vegetables in it may cause dew to form which has no effect on its performance. Remove the dew with dust cloth free from care.

General information

Vacation time	During average length vacations, you will probably find it best to leave the refrigerator in operation. Place freezable items in freezer for longer life. When you plan not to operate, remove all food, disconnect the power cord, clean the interior thoroughly, and leave each door OPEN to prevent odor formation.
Power failure	Most power failures that are corrected in an hour or two will not affect your refrigerator temperatures. However, you should minimize the number of door openings while the power is off.
If you move	Remove or securely fasten down all loose items inside the refrigerator. To avoid damaging the height adjusting screws, turn them all the way into the base.
Anti condensation pipe	The outside wall of the refrigerator cabinet may sometimes get warm, especially just after installation. Don't be alarmed. This is due to the anti-condensation pipe, which pumps hot refrigerator to prevent "sweating" on the outer cabinet wall.

CAUTION

- You must check the O-RING, which is made by rubber and prevent electric spark.
- Don't touch lamp, in case of light on the long time. Because it can be very hot.

Cleaning

It is important that your refrigerator be kept clean to prevent undesirable odors. Spilled food should be wiped up immediately, since it may acidify and stain plastic surfaces if allowed to settle.

Exterior	Use a lukewarm solution of mild soap or detergent to clean the durable finish of your refrigerator. Wipe with a clean damp cloth and then dry.
Interior	Regular cleaning is recommended. Wash all compartments a baking soda solution or a mild detergent and warm water. Rinse and dry.
After cleaning	Please verify that the power cord is not damaged, power plug is not overheated, or power plug is well inserted into the power consent.

WARNING

Always remove power cord from the wall outlet prior to cleaning in the vicinity of electrical parts (lamps, switches, controls, etc.).
Wipe up excess moisture with a sponge or cloth to prevent water or liquid from getting into any electrical part and causing an electric shock.
Never use metallic scouring pads, brushes, coarse abrasive cleaners, strong alkaline solutions, flammable or toxic cleaning liquids on any surface.
Do not touch frozen surfaces with wet or damp hands, because damp object will stick or adhere to extremely cold surfaces.

Smart Diagnosis

Should you experience any problems with your refrigerator, it has the capability of transmitting data via your telephone to the LG service center. This gives you the capability of speaking directly to our trained specialists. The specialist records the data transmitted from your machine and uses it to analyze the issue, providing a fast and effective diagnosis.

If you experience problems with your refrigerator, call to the LG service center. Only use the Smart Diagnosis feature when instructed to do so by the LG call center agent. The transmission sounds that you will hear are normal and sound similar to a fax machine.

Smart Diagnosis cannot be activated unless your refrigerator is connected to power. If your refrigerator is unable to turn on, then troubleshooting must be done without using Smart Diagnosis.

Using Smart Diagnosis

First, call to the LG service center. Only use the Smart Diagnosis feature when instructed to do so by the LG call center agent.

1. Lock the display. To lock the display, press and hold the Lock button for three seconds. (If the display has been locked for over five minutes, you must deactivate the lock and then reactivate it.)

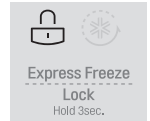

2. Open the right refrigerator door.

3. Hold the mouthpiece of your phone in front of the speaker that is located on the right hinge of the refrigerator door, when instructed to do so by the call center.



4. Press and hold the Freezer Temperature button for three seconds while continuing to hold your phone to the speaker.

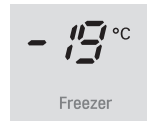

5. After you hear three beeps, release the Freezer Temperature button.
6. Keep the phone in place until the tone transmission has finished. This takes about 3 seconds, and the display will count down the time. Once the countdown is over and the tones have stopped, resume your conversation with the specialist, who will then be able to assist you in using the information transmitted for analysis.

NOTE

- For best results, do not move the phone while the tones are being transmitted.
- If the call center agent is not able to get an accurate recording of the data, you may be asked to try again.
- Call quality differences by region may affect the function.
- Use the home telephone for better communication performance, resulting in better service.
- Bad call quality may result in poor data transmission from your phone to the machine, which could cause Smart Diagnosis to not work properly.

Trouble shooting

Before calling for service, review this list. It may save you both time and expense. This list includes common occurrences that are not the result of defective workmanship or materials in this appliance.

Occurrence	Possible cause	Solution
Runing of refrigerator		
Refrigerator compressor does not run.	Refrigerator control is off.	Set refrigerator control. See setting the controls.
	Refrigerator is in defrost cycle.	This is normal for a fully automatic defrosting refrigerator. The defrost cycle occurs periodically.
	Plug at wall outlet is disconnected.	Make sure plug is tightly pushed into outlet.
	Power outage. Check house lights.	Call local electric company.
Refrigerator runs too much or too long	Refrigerator is larger than the previous one you owned.	This is normal. Larger, more efficient units run longer in these conditions.
	Room or outside weather is hot.	It is normal for the refrigerator to work longer under these conditions.
	Refrigerator has recently been disconnected for a period of time.	It takes some hours for the refrigerator to cool down completely.
	Large amounts of warm or hot food may have been stored recently.	Warm food will cause the refrigerator to run longer until the desired temperature is reached.
	Doors are opened too frequently or too long.	Warm air entering the refrigerator causes it to run longer. Open the door less often.
	Refrigerator or freezer door may be slightly open.	Make sure the refrigerator is level. Keep food and containers from blocking door. See problem section. OPENING/CLOSING of doors.
	Refrigerator control is set too cold.	Set the refrigerator control to a warmer setting until the refrigerator temperature is satisfactory.
	Refrigerator or freezer gasket is dirty, worn, cracked, or poorly fitted.	Clean or change gasket. Leaks in the door seal will cause refrigerator to run longer in order to maintain desired temperatures.
	Thermostat is keeping the refrigerator at a constant temperature.	This is normal. Refrigerator goes on and off to keep the temperature constant.

Occurrence	Possible cause	Solution
Refrigerator compressor does not run.	Thermostat is keeping the refrigerator at a constant temperature.	This is normal. The refrigerator goes on and off to keep the temperature constant.
Temperatures are too cold		
Temperature in the freezer is too cold but the refrigerator temperature is satisfactory.	Freezer control is set too cold	Set the freezer control to a warmer setting until the freezer temperature is satisfactory.
Temperature in the refrigerator is too cold and the freezer temperature is satisfactory.	Refrigerator control is set too cold.	Set the refrigerator control to a warmer setting
Food stored in drawers freezes.	Refrigerator control is set too cold.	See above solution.
Meat stored in fresh meat drawer freezes.	Meat should be stored at a temperature just below the freezing point of water (32°F, 0°C) for maximum fresh storage time.	It is normal for ice crystals to form due to the moisture content of meat.
Temperatures are too warm		
Temperatures in the refrigerator or freezer are too warm.	Freezer control is set too warm.	Set the freezer or refrigerator control to a colder setting until the freezer or refrigerator temperature is satisfactory.
	Refrigerator control is set too warm. Refrigerator control has some effect on freezer temperature.	Set the freezer or refrigerator control to a colder setting until the freezer or refrigerator temperature is satisfactory.
	Doors are opened too frequently or too long.	Warm air enters the refrigerator/ freezer whenever the door is opened. Open the door less often.
	Door is slightly open.	Close the door completely.
	Large amounts of warm or hot food may have been stored recently.	Wait until the refrigerator or freezer has a chance to reach its selected temperature.
	Refrigerator has recently been disconnected for a period of time.	A refrigerator requires some hours to cool down completely.
Temperature in the refrigerator is too warm but the freezer temperature is satisfactory.	Refrigerator control is set too warm.	Set the refrigerator control to a colder setting.

Occurrence	Possible cause	Solution
Sound and noise		
Louder sound levels when refrigerator is on.	Today's refrigerators have increased storage capacity and maintain more even temperatures.	It is normal for sound levels to be higher.
Louder sound levels when compressor comes on.	Refrigerator operates at higher pressures during the start of the ON cycle.	This is normal. The sound will level off as the refrigerator continues to run.
Vibrating or rattling noise.	Floor is uneven or weak. Refrigerator rocks on the floor when it is moved slightly.	Be sure floor is level and solid and can adequately support refrigerator.
	Items placed on the top of the refrigerator are vibrating.	Remove items.
	Dishes are vibrating on the shelves in the refrigerator.	It is normal for dishes to vibrate slightly. Move dishes slightly. Make sure refrigerator is level and firmly set on floor.
	Refrigerator is touching wall or cabinets.	Move refrigerator so that it does not touch the wall or refrigerator.
Water/Moisture/ Ice inside refrigerator		
Moisture collects on the inside walls of the refrigerator.	The weather is hot and humid which increases the rate of frost buildup and internal sweating.	This is normal.
	Door is slightly open.	See problem section opening/closing of doors.
	Door is opened too often or too long.	Open the door less often.
Moisture forms on the outside of the refrigerator or between doors.	Weather is humid.	This is normal in humid weather. When humidity is lower, the moisture should disappear.
	Door is slightly open, causing cold air from the inside the refrigerator to meet warm air from the outside.	This time, close the door completely.

Occurrence	Possible cause	Solution
Odors in refrigerator	Interior needs to be cleaned.	Clean interior with sponge, warm water and baking soda.
	Food with strong odor is in the refrigerator.	Cover food completely.
	Some containers and wrapping materials produce odors.	Use a different container or brand of wrapping materials.
Opening/ Closing of doors/Drawers		
Door(s) will not close.	Food package is keeping door open.	Move packages that keep door from closing.
Door(s) will not close.	Door was closed too hard, causing other door to open slightly.	Close both doors gently.
	Refrigerator is not level. It rocks on the floor when it is moved slightly.	Adjust the height adjusting screw.
	Floor is uneven or weak. Refrigerator rocks on the floor when it is moved slightly.	Be sure floor is level and can adequately support refrigerator. Contact carpenter to correct sagging or sloping floor.
	Refrigerator is touching wall or cabinets.	Move refrigerator..
Drawers are difficult to move.	Food is touching shelf on top of the drawer	Keep less food in drawer.
	Track that drawer slides on is dirty.	Clean drawer and track.

Warranty period of Linear Compressor :

Ten(10) years from the date of original retail purchase.

Part only (Consumer will be charged for labor)

Noises associated with normal operation and failure to follow instructions found in the use and care and installation guides or operating the unit in an unsuitable environment will not be covered under this warranty.

Disposal of the old appliance

This appliance contains fluid (refrigerant, lubricant) and is made of parts and materials which are reusable and/or recyclable.

All the important materials should be sent to the collection center of waste material and can be reused after rework (recycling). For take back, please contact with the local agency.

It is Normal...

The following occurrences are normal.

	Occurrence	Solution
Noise	When you hear "Tak" or "Took" sound	This is the sound of various parts expanding/contracting or various control devices operating depending on the temperature change within the refrigerator.
	When you hear "Deureureuk~", "Dulkuk" or "Woong" sound	This is the count of compressor or fan operating when the operation of the refrigerator is starting or ending. This is the same phenomenon of the sound generated when starting or turning off the engine of a car.
	When you hear "Kureureuk" sound of water flowing	This is the sound of refrigerant changing the condition in the freezer/fridge. When the liquid changes to gas, you will hear the sound of water flowing and when gas changes to liquid, you will hear the "Kureureuk" sound.
	When you hear the sound of wind such as "Shoo~" or "Shik" right after you close the door	This is the sound generated when the internal pressure is temporarily lowered when the warm air entered through the fridge or freezer is cooled fast.
	When you hear the vibrating sound	If the refrigerator is installed on wooden floor or wooden wall, or if the refrigerator is not leveled properly, the sound can be loud from the vibration.
	When you hear a loud sound after installing the product for the first time	When you operate the refrigerator for the first time, the refrigerator will operate at high speed to cool fast and the sound can seem louder. When the internal temperature falls below a certain level, the noise will subside.
Door open	When the door is slightly opened after closing the door.	Depending on the force or speed of closing the fridge or freezer door, the door can open slightly and then get closed. Be careful not to close the door too hard.
	When closing refrigerator door, freezer door open and close.	It is linked between the refrigerator and freezer in order to make cold air circulation. So, When close the refrigerator door, air in the refrigerator goes into the freezer. It makes the freezer door open. Please relax as it is not a breakdown.
Icing/ Dew drops	When there is icing or dew drops formed on the inner or outer side of the refrigerator	When external air flows into the cool inner surface of the refrigerator, icing/dew drops can be formed. Especially, this will happen more easily when you open and close the refrigerator door more frequently. Also if the humidity of the installed location is high or during the rainy season or on a rainy day, dew drops can form on the outer side of the refrigerator. This is a natural phenomenon that occurs during humid weather. Wipe the water drops with a dry cloth.
Temperature	When the front side of the refrigerator is warm	Heat pipes are installed around the front part of the refrigerator and on the divider of the freezer and fridge to prevent the dew drops from forming. The refrigerator may feel warmer after the installation or during the hot summer, but this is not a problem and you can be rest assured.

