



ENGLISH

OWNER'S MANUAL

Mini Hi-Fi System

Please read this manual carefully before operating your set and retain it for future reference.

CM4635T (CM4635T, CMS4630F)
CM4535T (CM4535T, CMS4530F, CMS4530W)
CM4435T (CM4435T, CMS4530F)
CM4335T (CM4335T, CMS4330F)



MFL67866486

Safety Information



CAUTION: TO REDUCE THE RISK OF ELECTRIC SHOCK DO NOT REMOVE COVER (OR BACK) NO USER-SERVICEABLE PARTS INSIDE REFER SERVICING TO QUALIFIED SERVICE PERSONNEL.



This lightning flash with arrowhead symbol within an equilateral triangle is intended to alert the user to the presence of uninsulated dangerous voltage within the product's enclosure that may be of sufficient magnitude to constitute a risk of electric shock to persons.



The exclamation point within an equilateral triangle is intended to alert the user to the presence of important operating and maintenance (servicing) instructions in the literature accompanying the product.

WARNING: TO PREVENT FIRE OR ELECTRIC SHOCK HAZARD, DO NOT EXPOSE THIS PRODUCT TO RAIN OR MOISTURE.

WARNING: Do not install this equipment in a confined space such as a book case or similar unit.

CAUTION: Do not block any ventilation openings. Install in accordance with the manufacturer's instructions.

Slots and openings in the cabinet are provided for ventilation and to ensure reliable operation of the product and to protect it from over heating. The openings shall be never be blocked by placing the product on a bed, sofa, rug or other similar surface. This product shall not be placed in a built-in installation such as a bookcase or rack unless proper ventilation is provided or the manufacturer's instruction has been adhered to.

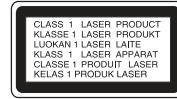

CAUTION: This product employs a Laser System. To ensure proper use of this product, please read this owner's manual carefully and retain it for future reference. Shall the unit require maintenance, contact an authorized service center. Use of controls, adjustments or the performance of procedures other than those specified herein may result in hazardous radiation exposure. To prevent direct exposure to laser beam, do not try to open the enclosure.

CAUTION concerning the Power cord

Most appliances recommend they be placed upon a dedicated circuit;

That is, a single outlet circuit which powers only that appliance and has no additional outlets or branch circuits. Check the specification page of this owner's manual to be certain. Do not overload wall outlets. Overloaded wall outlets, loose or damaged wall outlets, extension cords, frayed power cords, or damaged or cracked wire insulation are dangerous. Any of these conditions could result in electric shock or fire. Periodically examine the cord of your appliance, and if its appearance indicates damage or deterioration, unplug it, discontinue use of the appliance, and have the cord replaced with an exact replacement part by an authorized service center. Protect the power cord from physical or mechanical abuse, such as being twisted, kinked, pinched, closed in a door, or walked upon. Pay particular attention to plugs, wall outlets, and the point where the cord exits the appliance. To disconnect power from the mains, pull out the mains cord plug. When installing the product, ensure that the plug is easily accessible.

This device is equipped with a portable battery or accumulator.

Safety way to remove the battery or the battery from the equipment: Remove the old battery or battery pack, follow the steps in reverse order than the assembly. To prevent contamination of the environment and bring on possible threat to human and animal health, the old battery or the battery put it in the appropriate container at designated collection points. Do not dispose of batteries or battery together with other waste. It is recommended that you use local, free reimbursement systems batteries and accumulators. The battery shall not be exposed to excessive heat such as sunshine, fire or the like.

CAUTION: The apparatus shall not be exposed to water (dripping or splashing) and no objects filled with liquids, such as vases, shall be placed on the apparatus.

Disposal of your old appliance



1. When this crossed-out wheeled bin symbol is attached to a product it means the product is covered by the European Directive 2002/96/EC.
2. All electrical and electronic products should be disposed of separately from the municipal waste stream via designated collection facilities appointed by the government or the local authorities.
3. The correct disposal of your old appliance will help prevent potential negative consequences for the environment and human health.
4. For more detailed information about disposal of your old appliance, please contact your city office, waste disposal service or the shop where you purchased the product.

Disposal of waste batteries/accumulators



1. When this crossed-out wheeled bin symbol is attached to batteries/accumulators of Your product it means they are covered by European Directive 2006/66/EC.
2. This symbol may be combined with chemical symbols for mercury(Hg), cadmium(Cd) or lead(Pb) if the battery Contains more that 0.0005% of mercury,0.002% of cadmium or 0.004% of lead.
3. All batteries/accumulators should be disposed separately from the municipal waste stream via designated collection facilities appointed by the government or the local authorities.
4. The correct disposal of Your old batteries/accumulators will help to prevent potential negative consequences for the environment, animal and human health.
5. For more detailed information about disposal of Your old batteries/accumulators, please contact Your city office, waste disposal service or the shop where You purchased the product.

Table of Contents

1 Getting Started

- 2 Safety Information
- 6 Unique Features
- 6 Accesories
- 6 Playable file Requirement
 - 6 – MP3/WMA music file requirement
 - 7 – Compatible USB Devices
 - 7 – USB device requirement
- 8 Remote Control
- 9 Front Panel
- 11 Rear Panel(CM4535T)
- 12 Rear Panel(CM4635T)
- 13 Rear Panel(CM4435T/CM4335T)

2 Connecting

- 14 Connecting to speakers
 - 14 – Attaching the speakers to the unit
- 15 Antenna Connection
- 15 Optional Equipment Connection
 - 15 – AUX IN Connection
 - 16 – USB Connection

3 Operating

- 17 Basic Operations
 - 17 – CD/USB Operations
 - 17 Other Operations
 - 17 – Programmed Playback
 - 17 – Displaying file information
 - 17 – Searching for a folder
 - 18 – Turn off the sound temporarily
 - 18 – Deleting an MP3/WMA file
 - 18 – DEMO
 - 18 – AUTO DJ playback
- 19 Radio Operations
 - 19 – Listening to the radio
 - 19 – Presetting the Radio Stations
 - 19 – Deleting all the saved stations
 - 19 – Improving poor FM reception
- 20 Sound adjustment
 - 20 – Setting the surround mode
- 20 Setting the Clock
 - 20 – Setting the alarm
 - 21 – Sleep Timer Setting
 - 21 – Dimmer
- 21 Advanced Operations
 - 21 – Listening to the sound from your external device
- 22 Using a Bluetooth wireless technology
 - 22 – Listening to music of a Bluetooth device

4 Troubleshooting

24 Troubleshooting

5 Appendix

- 25 Specifications
- 26 Speaker specifications
- 27 Maintenance
 - 27 - Handling the Unit
 - 27 - Notes on Discs
- 27 Trademarks and Licenses

1

2

3

4

5

Unique Features

AUTO DJ

Blends the end of one song into the beginning of another for seamless playback.

USB

Listens to music from your USB device.

Radio

Listens to the radio.

Bluetooth®

Listens to music stored on your bluetooth device.

Accessories

Please check and identify the supplied accessories.

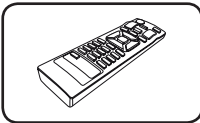

Remote Control (1)

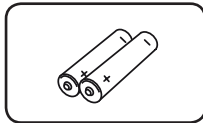

Batteries (2)

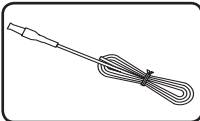

FM Antenna (1)

Playable file Requirement

MP3/WMA music file requirement

MP3/WMA file compatibility with this unit is limited as follows.

- Sampling frequency : within 32 to 48 kHz (MP3), within 32 to 48 kHz (WMA)
- Bit rate : within 32 to 320 kbps (MP3), 40 to 192 kbps (WMA)
- Maximum files : Under 999
- File extensions : ".mp3"/".wma"
- CD-ROM file format : ISO 9660/JOLIET
- We recommend that you use Easy-CD Creator, which creates an ISO 9660 file system.
- You have to set the disc format option to [Mastered] in order to make the discs compatible with the LG players when formatting rewritable discs. When setting the option to Live File System, you cannot use it on LG players. (Mastered/Live File System : Disc format system for Windows Vista)

Compatible USB Devices

- MP3 Player : Flash type MP3 player.
- USB Flash Drive :
Devices that support USB2.0 or USB1.1.
- The USB function of this unit does not support all USB devices.

USB device requirement

- Devices which require additional program installation when you have connected it to a computer, are not supported.
- Do not extract the USB device while in operation.
- For a large capacity USB, it may take longer than a few minute to be searched.
- To prevent data loss, back up all data.
- If you use a USB extension cable or USB hub, the USB device is not recognized.
- Using NTFS file system is not supported. (Only FAT(16/32) file system is supported.)
- This unit is not supported when the total number of files is 1 000 or more.
- External HDD, Card readers, Locked devices, or hard type USB devices are not supported.
- USB port of the unit cannot be connected to PC. The unit cannot be used as a storage device.

1

Getting Started

Remote Control

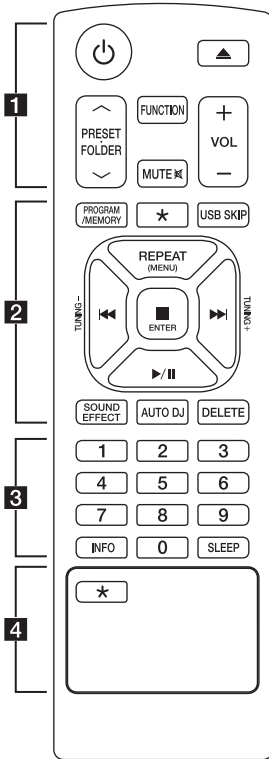

Battery Installation

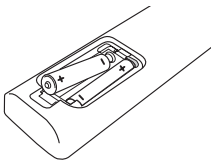

Remove the battery cover on the rear of the Remote Control, and insert two (size AAA) batteries with + and - matched correctly

..... **1**

Power : Switches the unit ON or OFF.

Open/Close : Opens and closes the disc tray.

PRESET-FOLDER \wedge /V :

- Searches for a folder of MP3/WMA files. When a CD/USB containing MP3/WMA files in several folders is being played, press **PRESET-FOLDER \wedge /V** to select the folder you want to play.

- Chooses a preset number for a radio station.

FUNCTION : Selects the function and input source.

MUTE : Mutes the sound.

VOL +/- : Adjusts speaker volume.

..... **2**

PROGRAM/MEMORY :

- Stores radio stations.

- Creates a playlist you want to listen to.

***** : The button is not available for any function.

USB SKIP : Switches between USB 1 and USB 2.

REPEAT(MENU) :

REPEAT : Listens to your tracks/files repeatedly or randomly.

MENU : This key have function only in the case of the SET have ipod function.

..... **3**

Skip/Search :

- Skips Fast backward or Forward.
- Searches for a section within a track/file.

TUNING-/+ : Selects the radio station.

ENTER :

- Stops playback.
- Cancels DELETE function.

Play/Pause :

- Starts or pauses playback.
- Selects STEREO/MONO.

SOUND EFFECT : Chooses sound impressions.

AUTO DJ : Selects the AUTO DJ mode. (For more information refer to the page 18)

DELETE : Deletes MP3/WMA files.

..... **4**

0 to 9 numerical buttons : Selects numbered tracks/files, or preset number.

INFO : Sees informations about your music.

SLEEP : Sets the system to turn off automatically at a specified time. (Dimmer : The display window will be darkened by half.)

..... **4**

***** : The button is not available for any function.

Front Panel

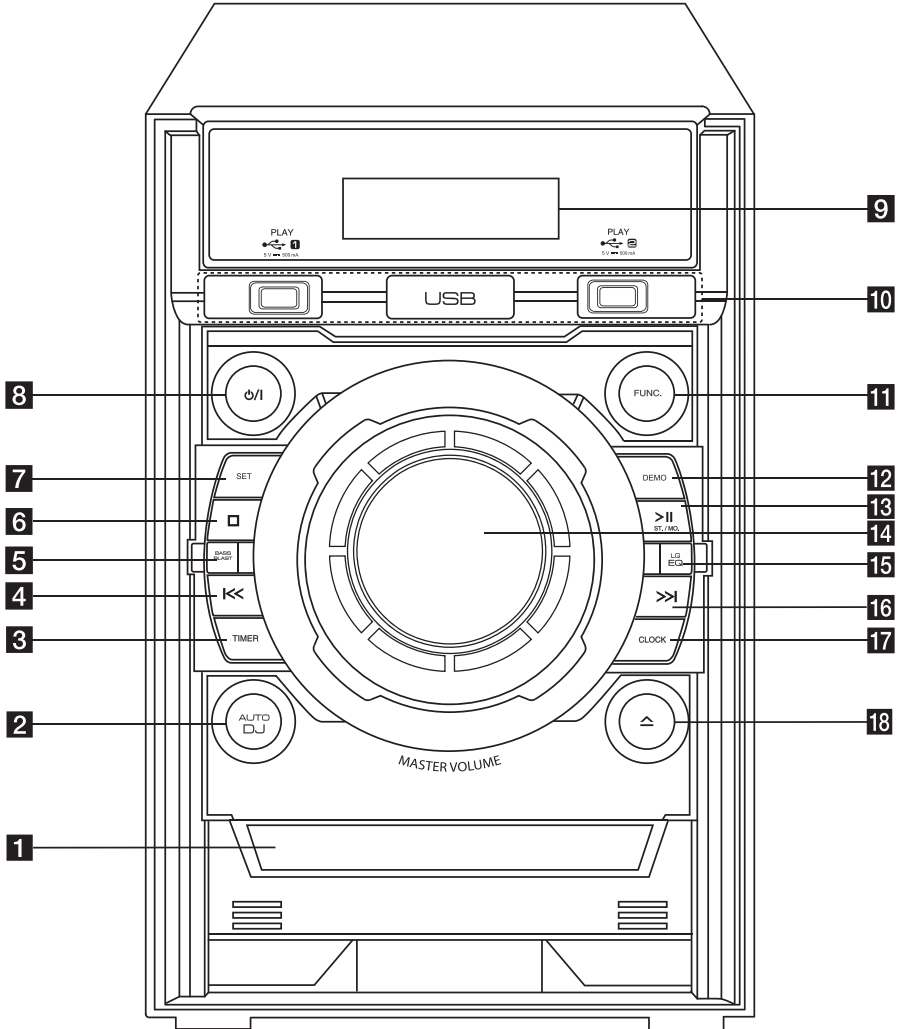

- 1** Disc tray
Loads a disc.
- 2** **AUTO DJ**
Selects the AUTO DJ mode.
(For more information refer to the page 18)
- 3** **TIMER**
Uses your unit as an alarm clock.
- 4** **⏮** (Skip/Search)
- Searches forward.
- Skips to the previous track/file.
- 5** **BASS BLAST**
Reinforces the treble, bass and surround effect.
- 6** **⏸** (Stop)
Stops playback.
- 7** **SET**
Confirms the setting.
- 8** **⏻** (Power)
Switches the unit ON or OFF.
- 9** Display window
- 10** USB
Plays the audio files by connecting the USB device.
- 11** **FUNC.**
Selects the function or input source.
- 12** **DEMO**
Demonstrates each of functions.
- 13** **⏮|ST./MO.**
- Starts or pauses playback.
- Selects Stereo/Mono.
- 14** Volume knob
Adjusts volume of speaker.
- 15** **LG EQ**
Chooses sound impression.
- 16** **⏭** (Skip/Search)
- Searches backward.
- Skips to the next track/file.
- 17** **CLOCK**
Sets the clock and checks the time.
- 18** **⏮** (Open/Close)
Opens and closes the disc tray.

Rear Panel(CM4535T)

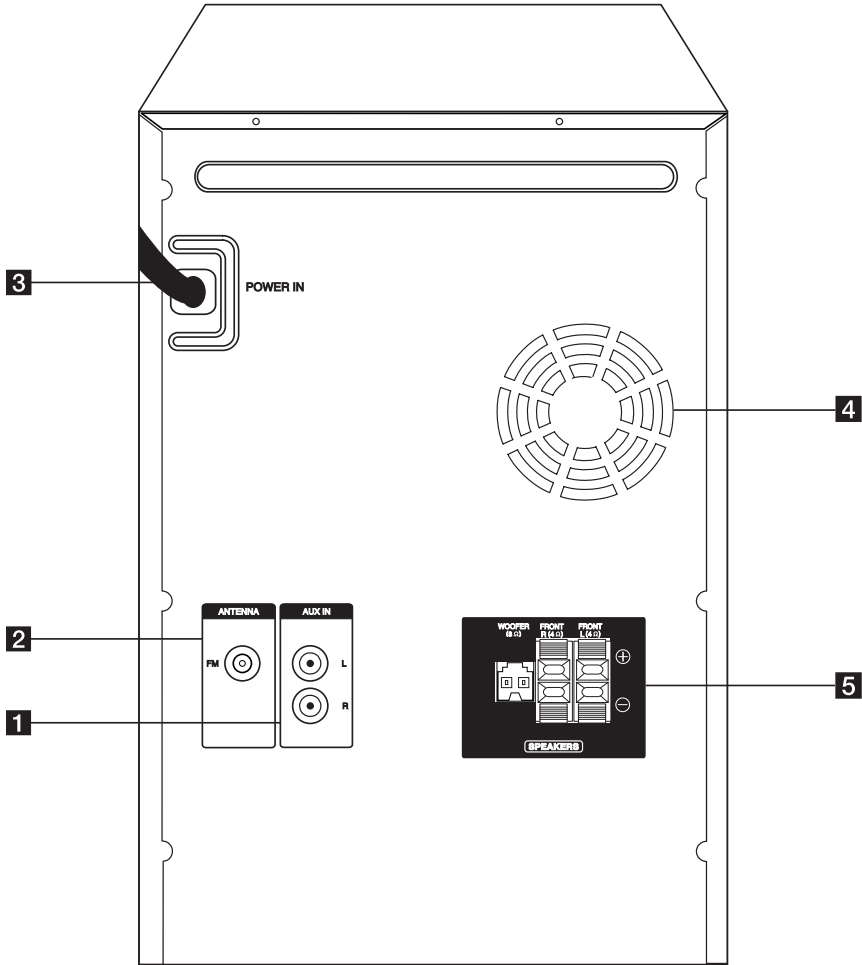

1 AUX IN (L/R) connectors

2 ANTENNA (FM)

3 POWER IN

4 Cooling fan

5 SPEAKERS terminal/Cord

1

Getting Started

1

Getting Started

Rear Panel(CM4635T)

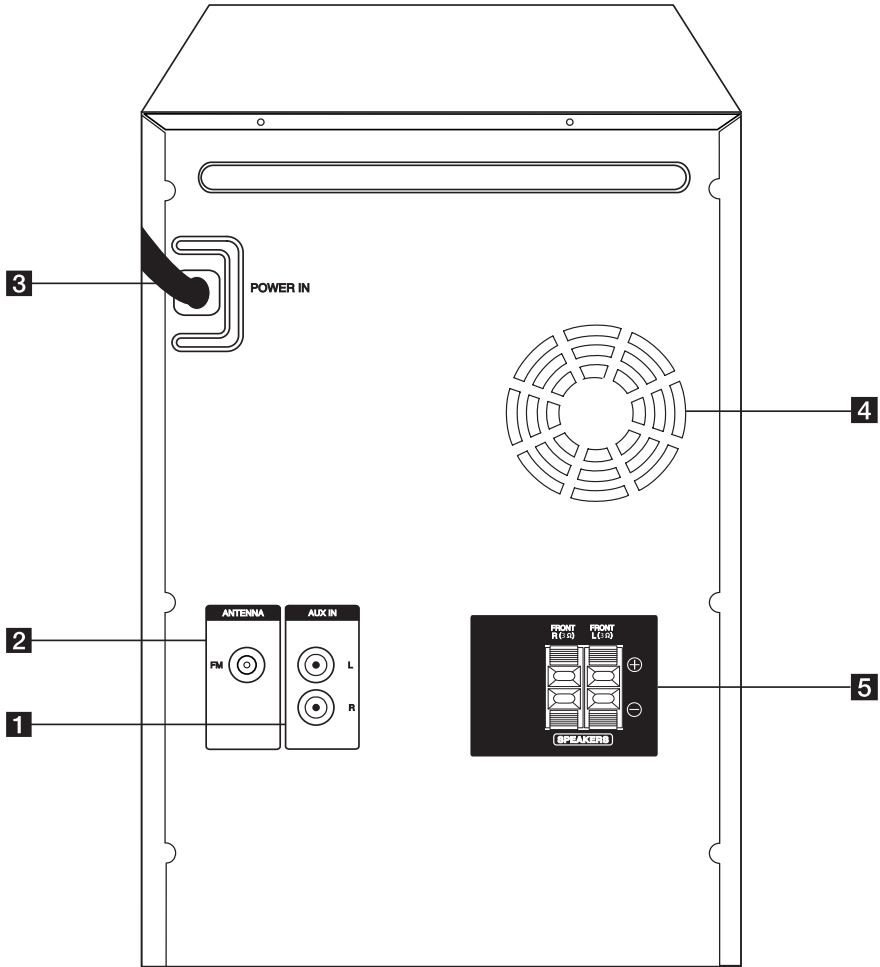

- 1 AUX IN (L/R) connectors
- 2 ANTENNA (FM)
- 3 POWER IN

- 4 Cooling fan
- 5 SPEAKERS terminal

Rear Panel(CM4435T/CM4335T)

1

Getting Started

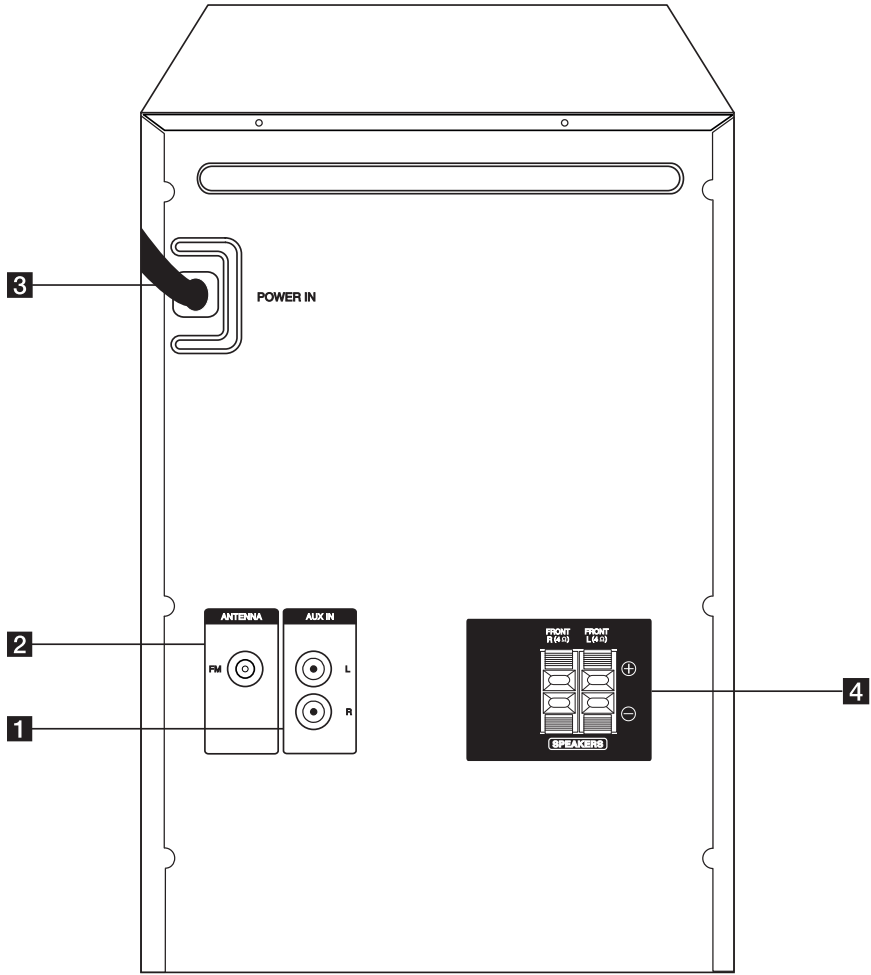

1 AUX IN (L/R) connectors

2 ANTENNA (FM)

3 POWER IN

4 SPEAKERS terminal

Connecting to speakers

Attaching the speakers to the unit

To connect the cable to the unit, press each plastic finger pad to open the connection terminals on the unit. Insert the wire and release the finger pad.

Connect the black stripe of each wire to the terminals marked - (minus) and the other end to the terminals marked + (plus).

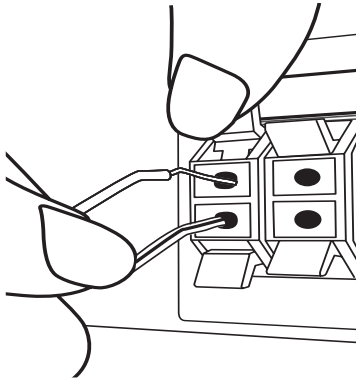

Connect a woofer cord to the player. When connecting a woofer cord to the player, insert the connector until it clicks.

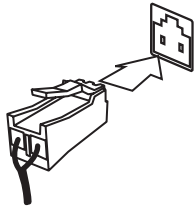

Caution

- Be careful to make sure children do not put their hands or any objects into the *speaker duct.
*Speaker duct: A hall for plentiful bass sound on speaker cabinet (enclosure)
- The speakers contain magnet parts, so color irregularity may occur on the TV screen or PC monitor screen. Please use the speakers far away from either TV screen or PC monitor.
- Do not connect any other speaker except sub woofer speaker to the sub woofer connection terminal on the rear of the unit.

CM4535T

Color	Speaker
Orange	Sub woofer
Red	Front
White	Front

CM4635T/CM4435T/CM4335T

Color	Speaker
Red	Front
White	Front

Antenna Connection

Connect the supplied FM antenna for listening to the radio.

Connect the FM wire antenna to the FM antenna connector.

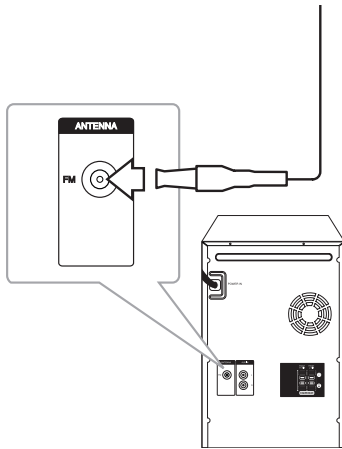

! Note

Be sure to fully extend the FM wire antenna.

Optional Equipment Connection

AUX IN Connection

Connect an output of auxiliary device (Camcorder, TV, Player, etc) to the **AUX IN(L/R)** connector.

If your device has only one output for audio (mono), connect it to the left (white) audio jack on the unit.

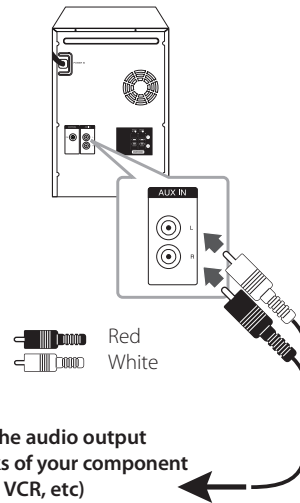

2

Connecting

USB Connection

Connect the USB port of USB Memory (or MP3 player, etc.) to the USB port on the front of the unit.

2
Connecting

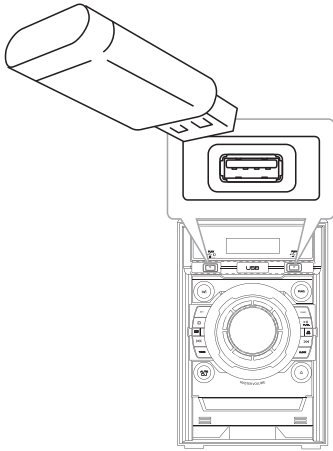

! Note

Removing the USB Device from the unit.

1. Choose a different function/mode or press  (Stop) twice in a row.
2. Remove the USB device from the unit.

Basic Operations

CD/USB Operations

1. Insert the disc by pressing **▲** on the remote control or **▲** on the unit.
Connect the USB device to the USB 1/2 port.
2. Select the CD or USB function by pressing **FUNCTION** on the remote control or **FUNC.** on the unit.
3. Select a track/file you want to play by pressing **◀◀/▶▶** on the remote control or **◀◀/▶▶** on the unit.

To	Do this
Stop	Press ■ ENTER or □ .
Playback	Press ▶/ or > ST./MO.
Pause	During playback, Press ▶/ or > ST./MO.
Skipping to the next/previous track/file	During playback, press ◀◀/▶▶ or ◀◀/▶▶ to go to the next track/file or to return to the beginning of the current track/file. Playing less than 2 seconds, press ◀◀ or ▶▶ to go to the previous track/file. Playing after 3 seconds, press ◀◀ or ▶▶ to go to the beginning of the track/file.
Selecting a track/file directly	Press 0 to 9 numerical buttons to go to the desired file or track directly.
Searching for a section within a track/file	Press and hold ◀◀/▶▶ or ◀◀/▶▶ during playback and release it at the point you want to listen to.
Playing repeatedly or randomly	Press REPEAT(MENU) repeatedly. The display will be changed in the following order. RPT1 -> RPT *DIR (only MP3/WMA) -> RPT ALL -> RANDOM -> OFF. *DIR : Directory

Other Operations

Programmed Playback

The program function enables you to store your favorite files from any disc or USB device.

A program can contain 20 tracks/files.

1. Insert a CD or connect your USB and wait for it to be ordered.
2. Press **PROGRAM/MEMORY** on the remote control in stop status.
3. Press **◀◀/▶▶** on the remote control to select a track/file.
4. Press **PROGRAM/MEMORY** again to save and select a next track/file.
5. Repeat steps 3-4 to select a next track/file.
6. Press **▶/||** to play the programmed music tracks/files.
7. To clear your selection, press **■ ENTER** twice.

! Note

The programs are also cleared when the disc or USB device is removed, the unit is powered off or the function is switched to others.

Displaying file information

While playing an MP3 file containing file information, you can display the information by pressing **INFO**.

Searching for a folder

1. Press **PRESET-FOLDER ▲/▼** on the remote control repeatedly until a desired folder appears in the display window.
2. Press **▶/||** to play it. The first file of the folder will be played.

Turn off the sound temporarily





Press **MUTE**  on the remote control to mute your sound.

You can mute your sound, for example, to answer the telephone, the "MUTE" will appear and blink in the display window.

To cancel it, press **MUTE**  again or change the volume level.

Deleting an MP3/WMA file

You can delete a file, folder or format by pressing **DELETE**. (USB only)

1. Press **DELETE** repeatedly while selecting the MP3/WMA file. This function is supported only in stop status. The display changes in the following order.
 - DEL FILE : Deletes file.
 - DEL DIR : Deletes folder.
 - FORMAT : Formats USB.
2. To delete file/folder or format, press /|| on the remote control or press || **ST./MO.** on the unit.
3. If you want to exit the current mode, press  **ENTER** on the remote control or press  on the unit.

Caution

- Do not extract the USB device during operation.(play, delete, etc.)
- Regular back up is recommended to prevent data loss.
- The delete function may not be supported according to the USB status.

DEMO

In power off state, press **DEMO** on the unit once. The unit will power on and display the each of functions in the display window. To cancel the DEMO function, press **DEMO** once more.

Note

- You can enjoy other functions during the DEMO. Then the DEMO will pause temporarily.
- Without input key in 10 sec, the DEMO will play back automatically.



AUTO DJ playback

Auto DJ blends the end of one song into the beginning of another for seamless playback. It equalizes volume across tracks for uninterrupted playback.

Press **AUTO DJ** on the remote control or unit repeatedly, the display changes as followings.
RANDOM (AUTO DJ RANDOM) -> RPT (AUTO DJ SEQUENTIAL) -> (AUTO DJ OFF)

Mode	Display Window	Description
OFF	- (AUTO DJ OFF)	-
RANDOM	RANDOM (AUTO DJ RANDOM)	The music is played randomly on this mode.
REPEAT	RPT (AUTO DJ SEQUENTIAL)	The music is played repeatedly on this mode.

Note

- Searching for a section within a track/file or playing repeatedly or randomly is not supported on the AUTO DJ mode.
- During AUTO DJ mode, it is not available to search file by pressing **PRESET-FOLDER** /V on the remote control.
- If you move to other functions or stop the music using  on the unit (or  **ENTER** on the remote control) on AUTO DJ mode, AUTO DJ function will be disable.
- AUTO DJ function is not supported in the music file whose length is less than 60 seconds.
- During recording, AUTO DJ function is not available.
- If you change a disc while the AUTO DJ function is activated, the function is deactivated.

Radio Operations

Be sure that FM aerial is connected.
(Refer to the page 15)

Listening to the radio

1. Press **FUNCTION** on the remote control or **FUNC.** on the unit until FM appears in the display window.
The last received station is tuned in.
2. Auto tuning : Press **TUNING -/+** on the remote control or **|<< / >>|** on the unit for about 2 seconds until the frequency indication starts changing, then release. scanning stops when the unit tunes in a station.
Manual tuning: Press **TUNING -/+** on the remote control or **|<< / >>|** on the unit repeatedly.
3. Adjust the volume by pressing **VOL +/-** on the remote control or by rotating volume knob on the unit repeatedly.

Presetting the Radio Stations

You can preset 50 stations for FM.

Before tuning, make sure to turn down the volume.

1. Press **FUNCTION** on the remote control or **FUNC.** on the unit until FM appears in the display window.
2. Select the desired frequency by pressing **TUNING-/+** on the remote control or **|<< / >>|** on the unit.
3. Press **PROGRAM/MEMORY**. A preset number will blink in the display window.
4. Press **PRESET-FOLDER ^/V** to select the preset number you want.
5. Press **PROGRAM/MEMORY**. The station is stored.
6. Repeat steps 2 to 5 to store other stations.
7. To listen to a preset station, press **PRESET-FOLDER ^/V** or **0** to **9** numerical buttons.

Deleting all the saved stations

1. Press and hold **PROGRAM/MEMORY** for two seconds. "ERASEALL" will blink in the unit display.
2. Press **PROGRAM/MEMORY** to erase all saved radio stations.

Improving poor FM reception

Press **▶/||** on the remote control or **>|| ST./MO.** on the unit. This will change the tuner from stereo to mono. Then the reception will be better than before.

Sound adjustment

Setting the surround mode

This system has a number of pre-set surround sound fields. You can select a desired sound mode by using **SOUND EFFECT** on the remote control or **LG EQ** on the unit.

The displayed items for the Equalizer may be different depending on sound sources and effects.

On Display	Description
NATURAL	You can enjoy comfortable and natural sound.
AUTO EQ	Realizes the sound equalizer that is the most similar to the genre of which is included in the MP3 ID3 tag of song files.
POP CLASSIC JAZZ ROCK	This program lends an enthusiastic atmosphere to the sound, giving you the feeling you are at an actual rock pop, jazz or classic concert.
MP3 -- OPT	This function is optimized for compressible MP3 file. It improves the treble sound.
BASS	Reinforces the treble, bass and surround sound effect.
LOUDNESS	Improves the bass and treble sound.
BYPASS	You can enjoy the sound without equalizer effect.

Note

- On some speakers, sound may not be heard or heard in low sound depending on the sound mode.
- Maybe you need to reset the surround mode, after switching the input, sometimes even after the sound track changed.
- By pressing **BASS BLAST** on the unit you can directly select the **BYPASS** or **BASS BLAST** sound.

Setting the Clock

1. Turn the unit on.
2. Press **CLOCK**.
3. Choose time mode by pressing **|<</>>|**.
- AM 12:00 (for an AM and PM display)
or 0:00 (for a 24 hour display)
4. Press **SET** to confirm your selection.
5. Select the hours by pressing **|<</>>|**.
6. Press **SET**.
7. Select the minutes by pressing **|<</>>|**.
8. Press **SET**.
9. If you want to reset the clock, press and hold **CLOCK**. Then repeat steps 3-8.

Setting the alarm

You can use the unit as an alarm clock. You have to set the clock before setting the alarm.

1. Turn the unit on.
2. Press **TIMER**.
3. Each of functions will blink. Press **SET** to select a sound source you want.
4. "ON TIME" will be displayed. This is your desired time to the unit turns on. Press **|<</>>|** to change the hours and minutes and press **SET** to save.
5. The "OFF TIME" will be displayed. This is your desired time to the unit turns off. Press **|<</>>|** to change the hours and minutes and press **SET** to save.
6. Press **|<</>>|** to change the volume and press **SET** to save. The clock icon "⌚" shows that the alarm is set.
7. Press **TIMER**. You can check the setting status.
8. If you want to reset the clock, press and hold **TIMER**. Then repeat step 3-6.

Sleep Timer Setting

Press **SLEEP** on the remote control repeatedly to select delay time between 10 and 180 minutes. After delay time, the unit will turn off. (You can see the following order, 180 -> 150 -> 120 -> 90 -> 80 -> 70 -> 60 -> 50 -> 40 -> 30 -> 20 -> 10). To cancel the sleep function, press **SLEEP** repeatedly until the display window get bright.

! Note

- Press **SLEEP**. The remaining time appears in the display window.
- Sleep function will work after dimmer function.

Dimmer

Press **SLEEP** once. The display window will be darkened by half. To cancel it, press **SLEEP** repeatedly until the display window get bright.

! Note

- After setting a clock function, you can set alarm function.
- If you set the clock and alarm, you can check the time and alarm icon "🕒" by pressing **CLOCK** although the unit is turned off.
- During playback, press **TIMER** two times when the alarm icon "🕒" is displayed. You can check the setting state.
- If you activate the alarm, the alarm icon "🕒" will appear in the display window.
- If you deactivate the alarm, the alarm icon "🕒" will disappear in the display window.
- Alarm function only works when the unit is turned off.
- If the time you set is up, the unit will be turned on automatically.

Advanced Operations

Listening to the sound from your external device

The unit can be used to play the sound from many types of external device. (Refer to the page 15)

1. Connect the external device to the **AUX IN(L/R)** connector of the unit.
2. Turn the power on by pressing **⏻/I**(Power).
3. Select the AUX function by pressing **FUNC.** on the unit.
4. Turn the external device and start playing it

Using a Bluetooth wireless technology

About Bluetooth

Bluetooth® is wireless communication technology for short range connection.

The available range is within 10 meters.

(The sound may be interrupted when the connection is interfered by the other electronic wave or you connect the bluetooth in the other rooms.)

Connecting individual devices under **Bluetooth®** wireless technology does not incur any charges. A mobile phone with **Bluetooth®** wireless technology can be operated via the Cascade if the connection was made via **Bluetooth®** wireless technology.
Available Devices : Mobile phone, MP3, Laptop, PDA.

Bluetooth Profiles

In order to use Bluetooth wireless technology, devices must be able to interpret certain profiles. This unit is compatible with following profile.

A2DP (Advanced Audio Distribution Profile)

Listening to music of a Bluetooth device

Before you start the pairing procedure, make sure the Bluetooth feature is turned on in to your Bluetooth device. Refer to your Bluetooth device's user guide. Once a pairing operation is performed, it does not need to be performed again.

1. Select the Bluetooth function by using the **FUNCTION** on the remote control or **FUNC.** on the unit. "BT READY" appears in the display window.
2. Operate the Bluetooth device and perform the pairing operation. When searching for this unit with the Bluetooth device, a list of the devices found may appear in the Bluetooth device display depending on the type of Bluetooth device. Your unit displays as "LG MINI (XX:XX)".

! Note

XX:XX means the last four digits of BT address. For example, if your unit has a BT address such as 9C:02:98:4A:F7:08, you will see "LG MINI (F7:08)" on your Bluetooth device.

3. Enter the PIN code.
PIN code : 0000
4. When this unit is successfully paired with your Bluetooth device, "BT PAIR" appears in the display window.

! Note

Depending on the Bluetooth device type, some devices have a different pairing way.

5. Listening to music.
To play a music stored on your Bluetooth device, refer to your Bluetooth device's user guide. According to your Bluetooth device's volume level, the volume level of Bluetooth will be adjusted.

! Note

- Sound from the main set can be distorted if you raise the volume of Bluetooth device up to two-thirds or more.
- When you use the Bluetooth function, adjust the volume of a Bluetooth device to a proper level to listen to.

Note

- After searching for this unit on your Bluetooth device, connect the Bluetooth device with this unit. Then play the file you want.
- The sound may be interrupted when the connection interfered by the other electronic wave.
- You cannot control the Bluetooth device with this unit.
- Pairing is limited one Bluetooth device per one unit and multi-pairing is not supported.
- Although the distance between your Bluetooth and the set is less than 10m, if there are obstacles between both, your Bluetooth device cannot be connected.
- Depending on the type of the device, you may not be able to use the Bluetooth function.
- You can enjoy wireless system using phone, MP3, Notebook, etc..
- When not connected the Bluetooth, "BT READY" appears in the display window.
- The Electrical malfunction due to devices using same frequency such as Medical equipment, Microwaves or wireless LAN devices, the connection will be disconnected.
- When someone stands and interrupts communication between Bluetooth device and the player, the connection will be disconnected.
- If the gotten away of the distance between Bluetooth and the unit, the sound quality is lower and lower. The connection will be disconnected when the space between the Bluetooth and the unit gets out of the operating range of Bluetooth.
- The device with Bluetooth wireless technology is disconnected, if you turn off the main unit or put the device away from the main unit more than 10m.
- If the Bluetooth device is disconnected, you should connect the Bluetooth device to your unit.

Troubleshooting

Problem	Cause & Correction
No Power.	<ul style="list-style-type: none"> • The power cord is not plugged in. Plug in the power cord. • Check whether electricity failed. Check the condition by operating other electronic devices.
No sound.	<ul style="list-style-type: none"> • Check whether you select a right function. Press FUNC. and check the selected function. • Speaker cables are not connected correctly. Connect speaker cables correctly.
The unit does not start playback.	<ul style="list-style-type: none"> • An unplayable disc is inserted. Insert a playable disc. • No disc is inserted. Insert a disc. • The disc is dirty. Clean the disc. (Refer to the 27 page) • The disc is inserted upside down. Place the disc with the label or printed side facing upwards.
Radio stations cannot be tuned in properly.	<ul style="list-style-type: none"> • The antenna is positioned or connected poorly. Connect the antenna securely. • The signal strength of the radio station is too weak. Tune to the station manually. • No stations have been preset or preset stations have been cleared (when being tuned by scanning preset channels). Preset some radio stations, see page 19 for details.
The remote control does not work properly.	<ul style="list-style-type: none"> • The remote control is too far from the unit. Operate the remote control within about 23 ft (7 m). • There is an obstacle in the path of the remote control and the unit. Remove the obstacle. • The batteries in the remote control are exhausted. Replace the batteries with new ones.

Specifications

General				
Model	CM4635T	CM4535T	CM4435T	CM4335T
Power requirements	Refer to the main label.			
Power consumption	Refer to the main label.			
Dimensions (W x H x D)	202 x 307 x 315 mm			
Net Weight (Approx.)	3.15 kg			
Operating temperature	5 °C to 35 °C (41 °F to 95 °F)			
Operating humidity	5 % to 90 %			
Bus Power Supply	DC 5 V  500 mA			

Inputs	
AUX IN	2.0 Vrms (1 kHz, 0 dB), 75 Ω, RCA jack (L, R) x 1

Tuner	
FM Tuning Range	87.5 to 108.0 MHz or 87.50 to 108.00 MHz

Amplifier					
Model	CM4635T	CM4535T	CM4435T	CM4335T	
Stereo mode		250 W + 250 W (3 Ω at 1 KHz, THD 10 %)	160 W + 160 W (4 Ω at 1 KHz, THD 10 %)	150 W + 150 W (4 Ω at 1 KHz, THD 10 %)	90 W + 90 W (4 Ω at 1 KHz, THD 10 %)
Surround mode	Front	250 W + 250 W (3 Ω at 1 KHz, THD 10 %)	160 W + 160 W (4 Ω at 1 KHz, THD 10 %)	150 W + 150 W (4 Ω at 1 KHz, THD 10 %)	90 W + 90 W (4 Ω at 1 KHz, THD 10 %)
	Subwoofer	-	180 W (3 Ω at 1 KHz, THD 10 %)	-	-

CD	
Frequency Response	100 to 20 000 Hz
Signal-to-noise ratio	75 dB
Dynamic range	80 dB

Speaker specifications

Front speaker				
Model	CMS4630F	CMS4530F (CM4535T)	CMS4530F (CM4435T)	CMS4330F
Type	2 Way 2 Speaker			
Impedance	3 Ω	4 Ω		
Rated Input Power	250 W	160 W	150 W	90 W
Max. Input power	500 W	320 W	300 W	180 W
Net Dimensions (W x H x D)	245 x 452 x 275 mm	232 x 352 x 262 mm	232 x 352 x 262 mm	204 x 301 x 235 mm
Net Weight	5.55 kg	3.32 Kg	3.32 Kg	2.48 Kg

Subwoofer speaker	
Model	CMS4530W
Type	1 Way 1 Speaker
Impedance	3 Ω
Rated Input Power	180 W
Max. Input power	360 W
Net Dimensions (W x H x D)	250 x 352 x 327 mm
Net Weight	5.58 kg

- Design and specifications are subject to change without notice.

Maintenance

Handling the Unit

When shipping the unit

Please save the original shipping carton and packing materials. If you need to ship the unit, for maximum protection, re-pack the unit as it was originally packed at the factory.

Keeping the exterior surfaces clean

Do not use volatile liquids such as insecticide spray near the unit.

Wiping with strong pressure may damage the surface.

Do not leave rubber or plastic products in contact with the unit for a long period of time.

Cleaning the unit

To clean the player, use a soft, dry cloth. If the surfaces are extremely dirty, use a soft cloth lightly moistened with a mild detergent solution. Do not use strong solvents such as alcohol, benzine, or thinner, as these might damage the surface of the unit.

Maintaining the Unit

The unit is a high-tech, precision device. If the optical pick-up lens and disc drive parts are dirty or worn, the picture quality could be diminished. For details, please contact your nearest authorized service center.

Notes on Discs

Handling Discs

Never stick paper or tape on the disc.

Storing Discs

After playing, store the disc in its case. Do not expose the disc to direct sunlight or sources of heat and never leave it in a parked car exposed to direct sunlight.

Cleaning Discs

Do not use strong solvents such as alcohol, benzine, thinner, commercially available cleaners, or anti-static spray intended for old vinyl records.

Trademarks and Licenses



Bluetooth® wireless technology is a system which allows radio contact between electronic devices within a max. range of 10 meters.

Connecting individual devices under **Bluetooth**® wireless technology does not incur any charges. A mobile phone with **Bluetooth**® wireless technology can be operated via the Cascade if the connection was made via **Bluetooth**® wireless technology.

The **Bluetooth**® word mark and logos are owned by the **Bluetooth**® SIG, Inc. and any use of such marks by LG Electronics is under license.

Other trademarks and trade names are those of their respective owners.

	Телефон	Режим работы	Интернет
Россия	8-800-200-7676	Круглосуточно	http://www.lg.com
Беларусь	8-820-0071-1111		
Латвия	8-0200-201	9:00 - 17:00 (Пн.-Пт.)	
Литва	8-800-08-081		
Эстония	800-9990	8:00 - 21:00 (Пон.-Пят.) 8:30 - 18:30 (Суб., Нд.)	
Україна	0-800-303-000		
Казахстан	8-8000-805-805	9:00-20:00 (Пн.-Пят.)	
	2255 (GSM)	9:00-18:00 (Суб., Вс.)	
Узбекистан	8 800 120 2222	9:00 - 18:30 (Пн.- Пят.) 9:00 - 15:00 (Суб., Вс.)	
Кыргызстан	800 0071 0005	Круглосуточно	
Молдова	00-800-0071-0005 (Тольоно для стационарних телефонів)	Круглосуточно	



	Символ «не для пищевой продукции» применяется в соответствие с техническим регламентом Таможенного союза «О безопасности упаковки» 005/2011 и указывает на то, что упаковка данного продукта не предназначена для повторного использования и подлежит утилизации. Упаковку данного продукта запрещается использовать для хранения пищевой продукции.	Символ Кедендік одақтың 005/2011 техникалық регламентіне сәйкес қолданылады және осы өнімнің қаптамасын екінші рет пайдалануға арналмағанын және жоюға жататынын көрсетеді. Осы өнімнің қаптамасын азық-түлік өнімдерін сақтау үшін пайдалануға тыйым салынады.
	Символ «петля Мебиуса» указывает на возможность утилизации упаковки. Символ может быть дополнен обозначением материала упаковки в виде цифрового и/или буквенного обозначения.	Символ қаптаманы жою мүмкіндігін көрсетеді. Символ сандық код және/немесе әріп белгілері түріндегі қаптама материалының белгісімен толықтырылуы мүмкін.

Российская Федерация

Импортер ООО "ЛГ Электроникс Рус"

Адрес импортера: 143160 Российская Федерация, Московская область, Рузский район, сельское поселение Дороховское, 86 км. Минского шоссе, д.9

Адрес производителя : ЛГ Электроникс (Хужоу) Инк., завод Хатаи, 516006, Китай, пров. Гуандонг, г. Хужоу, Промышленная зона Жонгкай, Индустриальный парк Хутаи, ХуФенг Донг Уи Роуд, 13.

Сделано в Китае

Україна

Найменування та адреса імпортера
ПІІ «ЛГ ЕЛЕКТРОНІКС Україна» вул.
Басейна, 6, м. Київ, 01004,
Тел. : 044 201-43-50

Қазақстан Республикасы

Импорттаушы АҚ "ЭЛ Джи Электроникс Алматы Қазақстан", 050061, Алматы қ., к. Көкөрай, 2А

Өндірушінің мекенжайы: 516006, Қытай, Гуандонг ауданы, Хужоу қаласы, Жонгкай өнеркәсіптік аймағы, Хутаи Индустриалық саябағы, ХуФенг Донг Уи Роуд, 13.

Қазақстан Республикасы территориясында тұтынушылардан келіп түскен талаптар мен ұсыныстарды қарайтын және тауарды жөндеу мен техникалық қызмет көрсететін ұжым:

АҚ «Эл Джи Электроникс Алматы Қазақстан», 050061, Қазақстан Республикасы, Алматы қ., Көкөрай, 2А. Басқа сервис орталықтары жайында мағлұматты "Тұтынушыға қызмет көрсету орталығына" телефон шалу арқылы білуге болады.

Қытайда жасалған