



ENGLISH

PL

OWNER'S MANUAL REFRIGERATOR- FREEZER

**Please read carefully the manual instruction and safety caution
before operating your refrigerator and retain it for future reference**



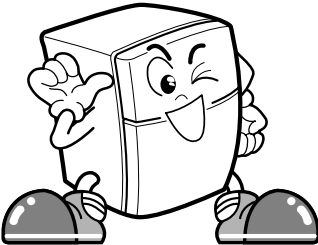

CONTENTS

IMPORTANT SAFETY INFORMATION	3
INSTALLATION	10
INNER PARTS	11
OPERATIONS	14
Starting	
Before Setting The Temperature	
Door Alarm	
Self Test	
Controls For Refrigerator Compartment	
Express Freeze	
Lock	
Hygiene Fresh (Optional)	
Controls For Freezer Compartment	
Ice Making	
Defrosting	
Vegetable Drawer	
Deodorizer (Optional)	
Refreshment Center (Optional)	
Water Dispenser	
SUGGESTIONS ON FOOD STORAGE	20
CLEANING	21
GENERAL INFORMATION	23
LAMP REPLACEMENT	23
IMPORTANT WARNINGS	24
BEFORE CALLING FOR SERVICE	25
SMART DIAGNOSIS.....	26



IMPORTANT SAFETY INFORMATION

WARNING

-  Keep ventilation openings, in the built-in structure, clear of obstruction.
-  Do not damage the refrigerant circuit.
-  Do not use electrical appliances inside the food storage compartment of the appliance, unless they are of the type recommended by the manufacturer.
-  The refrigerant and insulation blowing gas used in the appliance require special disposal procedures. When disposal, please consult with your local city council or a similarly qualified person.



This appliance contains a small amount of isobutane refrigerant (R600a), natural gas with high environmental compatibility, but it is also combustible. When transporting and installing the appliance, care should be taken to ensure that no parts of the refrigerating piping system are damaged. Refrigerant leaking out of the pipes could ignite or cause an eye injury. If a leak is detected, avoid any naked flames or potential sources of ignition and air the room in which the appliance is standing for several minutes.

In order to avoid the creation of a flammable gas air mixture if a leak in the refrigerating piping system occurs, the size of the room in which the appliance may be sited depends on the amount of refrigerant used. The room must be 1 m² in size for every 8g of R600a refrigerant inside the appliance. The amount of refrigerant in your particular appliance is shown on the identification plate inside the appliance. Never start up an appliance showing any signs of damage. If in doubt, consult your dealer.

IMPORTANT SAFETY INFORMATION

BASIC SAFETY PRECAUTIONS

This guide contains many important safety messages. Always read and obey all safety messages.



This is the safety alert symbol. It alerts you to safety messages that inform you of hazard that can hurt you or others or cause damage to the product. All safety messages will be preceded by the safety alert symbol and the hazard signal word WARNING, or CAUTION.

These words mean:



WARNING

Death or serious injury can occur if you don't follow instructions.



CAUTION

indicates an imminently hazardous situation which, if not avoided, may result in minor or moderate injury, or product damage only.

All safety messages will identify the hazard, tell you how to reduce the chance of injury, and tell you what can happen if the instructions are not followed.



WARNING

To reduce the risk of fire, electric shock, or injury to persons when using your product, basic safety precautions should be followed, including the following.

Read all instructions before using this appliance. This appliance is intended for domestic, indoor use only.

1. When connecting the power

Do not use many power outlets.

- Using several devices from one power outlet may cause fire.
- The electric leakage breaker may trip and cause food to spoil and contaminate the refrigerator.

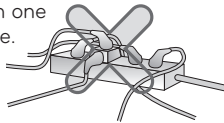

Do not allow the power plug to face upward or to be compressed at the back of the refrigerator.

This could damage the plug causing fire and electric shock.

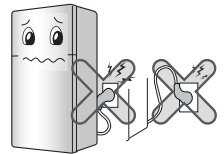

Prevent the power cord from being squeezed or imprinted if the refrigerator is pushed in after the power plug is extracted during the installation.

It becomes the cause of fire or electric shock.

Do not allow the power cord to be bent, kinked, or crushed by heavy objects.

It may damage the power cord and cause fire or electric shock.



IMPORTANT SAFETY INFORMATION

1. When connecting the power

Do not extend or modify the length of the power cord or power plug.

It can cause electric shock and/or fire and damage the refrigerator.



Unplug the power plug when cleaning, handling or replacing the interior lamp of the refrigerator.

- Not doing so may cause electric shock or injury.
- When replacing the interior lamp of the refrigerator, make sure that the rubber ring for preventing an electric spark within the socket is not taken off.

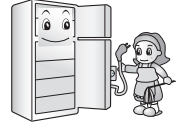

Do not remove the power plug with wet hands or by grasping the end and pulling on it.

It may cause electric shock, fire, short circuit or an electric shock hazard.



Remove water or dust from the power plug and insert it with the ends of the pins securely connected.

Dust, water or an unstable connection into the wall may cause fire and electric shock.

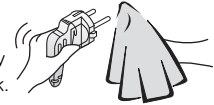

Do not pull out the cord or touch the power plug with wet hands.

- It may cause electric shock or injury.

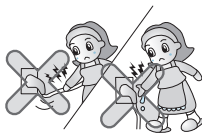

After disconnecting the power plug, wait for 5 minutes or longer before reconnecting the plug.

It may cause the operation of the freezer to fail.

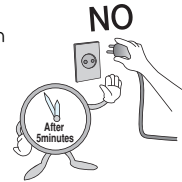

Make sure of grounding.

Make sure that the earth pin on the power plug is not missing or damaged. Poor earthing can cause a malfunction, and electric shock.

When the power cord or the power plug is damaged or the holes of the outlet are damaged or worn, do not use them.

It may cause electric shock or short circuit and cause a fire.

IMPORTANT SAFETY INFORMATION

2. When using the refrigerator

Do not place heavy, or dangerous objects or any containers containing fluids on top of the refrigerator.

It may fall or spill and cause injury, fire or electric shock when opening or closing the door.



Do not swing on any of the doors, or step on the door shelves for any reason.

It may cause the refrigerator to lean and fall over causing serious injury or death. Do not allow children to play with the refrigerator or any of its parts.



Always prevent children from entering the product.

It may endanger the life of a child if the child enters the refrigerator.

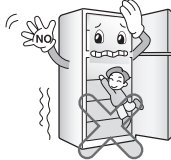

Do not place a flower vase, cup, cosmetics, medicine or any container with water on the refrigerator.

It may cause damage, fire, electric shock or injury if it spills over.

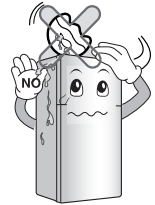

Do not use or store inflammable materials ether, benzene, alcohol, medicine, LP gas, spray or cosmetics near or in the refrigerator.

It may cause explosion or fire.

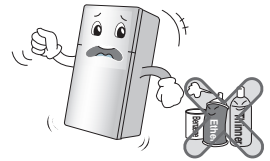

Do not install the refrigerator outdoors, in direct Sunlight, or where it can be exposed to environmental conditions, or in wet place or area.

This could cause malfunction, corrosion, fire and electric shock.



Do not store medicine, scientific material, paint or living compounds inside the refrigerator.

Such materials can cause dangers and hazards, and result in malfunction or serious injury. Storing strict temperature medicines in the refrigerator may cause them to become unstable and adversely compromise the effect of their purpose.

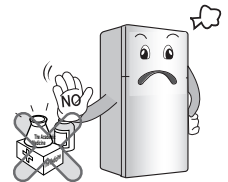

IMPORTANT SAFETY INFORMATION

2. When using the refrigerator

Do not use a hair dryer to dry the inside, or light a candle to remove odor.

It may cause an explosion or fire.

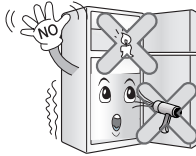

Avoid direct heat sources.

It may cause damage, malfunction, and fire.

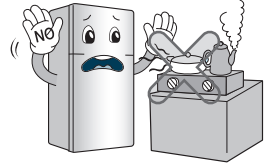

Do not use any combustible spray near the refrigerator.

It may cause fire and affect the refrigerator's finish.

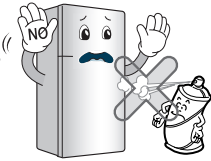

Do not use the refrigerator if it has been submerged in water without having it checked by a qualified electrician.

It may cause electric shock or fire.

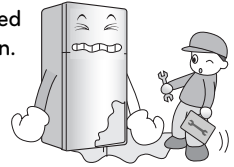

In case of a severe electrical storm, remove the power cord from the power outlet until the storm eases and avoid opening the doors during that time.

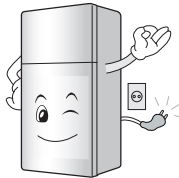

This appliance is not intended for use by persons (including children) with reduced physical, sensory or mental capabilities, or lack of experience and knowledge, unless they have been given supervision or instruction concerning use of the appliance by a person responsible for their safety.

Children should be supervised to ensure that they do not play with the appliance.

If the refrigerant gas is leaked, do not touch the refrigerator or the air outlet ventilate the room immediately.

- A spark may cause an explosion resulting in a fire or burns.
- Because this refrigerator uses natural gas as the environment-friendly refrigerant, even a small amount is combustible. If there is a gas leak caused by the severe damage during delivering, installing or using the refrigerator, any static electricity or spark could cause an explosion resulting in injury or burns.

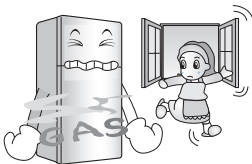

Do not spray water directly inside or on to the outside of the refrigerator, or clean it with abrasive caustic based liquids or pads, or solvents of any kind.

This can cause damage to the units finish, corrosion, and deterioration of electrical parts causing electric shock or malfunction.

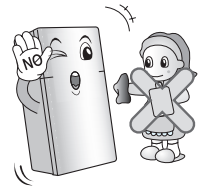

IMPORTANT SAFETY INFORMATION

2. When using the refrigerator

Do not allow any person except a qualified engineer to disassemble, repair or alter the refrigerator.

It may cause injury, electric shock or fire.

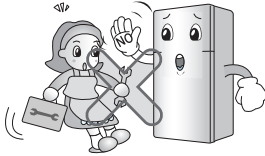

When any strange smell or smoke is detected from the refrigerator, disconnect the power plug immediately and contact to the service center.

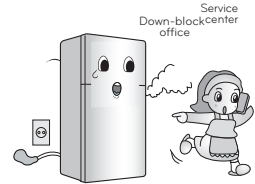

When disposing the refrigerator, remove the door seals from both doors or remove the doors completely.

Not doing so may cause children to suffocate if they become trapped inside.



Do not use the refrigerator for commercial based purposes including mobile applications.

A hazard or danger may result from it's non intended purpose such as electric shock, fire or unwarranted malfunction.

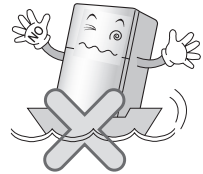

Install the refrigerator on the solid and level floor.

Installing it on an unstable surface could cause it to fall or tip over when opening the door causing serious injury or death.



What to do with your old refrigerator,
Your refrigerator contain liquid (refrigerant, lubricant) made of recyclable materials. All these materials must be sent to a recycling waste disposal site as they can be reused after a specific recycling process. Refrigerator Contact your local city Council for proper disposal advise

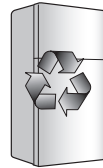

Do not obstruct the cold air outlets with hands or objects. Do not obstruct the rear lower ventilation grill.

It may cause overheating, electric shock or injury.

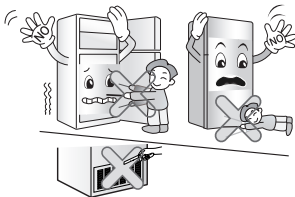

Remove all items from the door baskets before removing them.

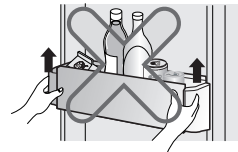

IMPORTANT SAFETY INFORMATION

2. When using the refrigerator

Do not remove the cover on the back.

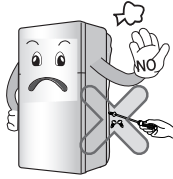

Place all the internal shelving and parts in the right places before connecting the power.

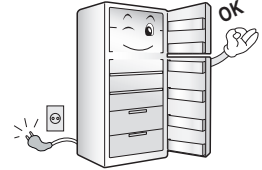

Do not use an Adapter.



Never use lit candles or incense on the fridge, at risk of causing fire or product damage.



CAUTION

Violating this direction may cause injury or damage to your house or furniture. Always be careful, please.

Do not touch food or containers in the freezer with wet hands.

It may cause frostbite



Do not overstack food in the refrigerator or block the air outlets.

Doing so could cause food to fall when the doors are opened or poor cooling or freezing of some items.

Do not store or place any sealed or full bottles in the freezer.

The bottle may explode when frozen and cause damage and injury.



Do not insert or place hands into the bottom of the refrigerator.

The steel plate underneath the refrigerator may cause injury.



Carry the refrigerator using the in built recessed handles both at the rear at the top, and underneath at the front.

Not doing so could cause the unit to slip and cause serious personal injury and damage the unit.

Because the product is heavy, carrying it alone may hurt people or accidents may occur.

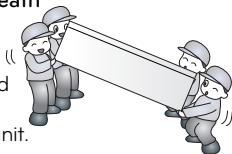

Please use caution when opening or closing the doors.

Children or pets should be kept clear of the refrigerator when opening or closing the doors to avoid injury.

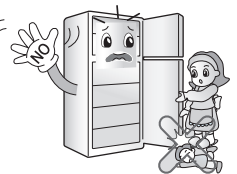

IMPORTANT SAFETY INFORMATION

Do not put any living matter, animals, pets or children, in or on the refrigerator.

It may cause death or serious injury.

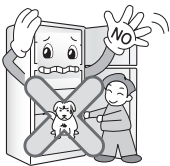

Do not use products such as abrasive sponges, brushes or pads to clean the surfaces. Do not use solvents, chlorine, Stainless Steel cleaners or other chemicals. These products may damage the protective lacquer, and they may cause a fire risk or stain on the surface of the refrigerator.

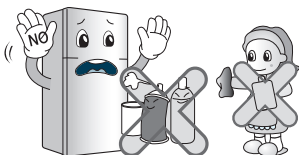

Avoid contact of fats and oils (including vegetable) onto plastic parts of the refrigerator. This causes the plastic to discolour and weaken.

If the power cord is damaged, call only a licenced electrician or an authorised Service provider to repair it.

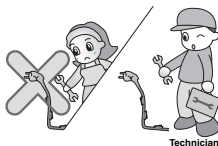

Do not store explosive substances such as aerosol cans with a flammable propellant in this appliance

! WARNING

Please do not use a dishwasher to clean the lower drawers; the high temperature may cause damage to the baskets which make them unusable.

Do not use carbonated water in the water tank. The gas pressure may cause leakage.

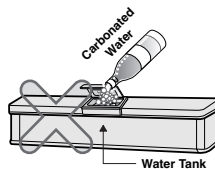

! WARNING

Fill with potable water only.

Rinse out the water tank and ice making tray before using them for the first time.

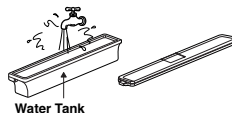

Do not apply oil or lubricants to the door hinges under any circumstances. It may cause damage to the plastic parts.

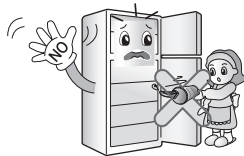

Use only water. If any other liquid is used, the operation of the system may deteriorate. Malfunctions caused by liquids other than water will not be covered by the manufacturers warranty.

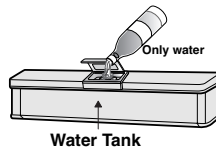

THIS REFRIGERATOR IS MANUFACTURED WITH GREAT CARE, AND UTILIZES THE LATEST IN TECHNOLOGY.

WE ARE CONFIDENT THAT YOU WILL BE FULLY SATISFIED WITH IT'S PERFORMANCE AND RELIABILITY.

BEFORE YOU START YOUR REFRIGERATOR, PLEASE READ THIS BOOKLET CAREFULLY. IT PROVIDES EXACT INSTRUCTIONS FOR INSTALLATION, OPERATION AND MAINTENANCE, AND ALSO SUPPLIES SOOME USEFUL HINTS.

INSTALLATION

1. Select a good location.

Place your refrigerator where it is easy to use.

2. Avoid placing the unit near or next to heat sources, direct sunlight or moisture.

Do not install the refrigerator in an open or sheltered outdoor environment.



3. Air must circulate properly around your refrigerator to ensure efficient operation. If your refrigerator is placed in a recessed area in the wall, allow at least 10 inches (25 cm) or greater clearance above the refrigerator and 2 inches (5 cm) or more from the wall. The refrigerator should be elevated 1 inch (2.5 cm) from the floor, especially if the floor is carpeted.

4. To avoid vibrations, the unit must be level.

If required, adjust the leveling screws to compensate for unevenness of the floor.

The front should be slightly higher than the rear to aid in door closing.

The front leveling screws can be turned easily by tipping the cabinet slightly.

Turn the leveling screws clockwise() to raise the unit, counterclockwise() to lower it.

5. Don't install this appliance in an environment below 5 °C. as it may cause malfunction or poor operation.

NEXT

1. Clean your refrigerator thoroughly and wipe off all dust accumulated during shipping.

2. Install accessories such as ice cube box, etc, in their proper places. They are packed together to prevent possible damage during shipment.

3. Connect the power supply cord (or plug) to the outlet. Don't double up with other appliances on the same outlet.

4. Prior to storing food, leave your refrigerator on for 3 or 4 hours.

Check the flow of cold air in the freezer compartment to ensure proper cooling.

Your refrigerator is now ready for use.

See page 17 for recommended temperature settings.

INNER PARTS

☐ NON DISPENSER MODEL

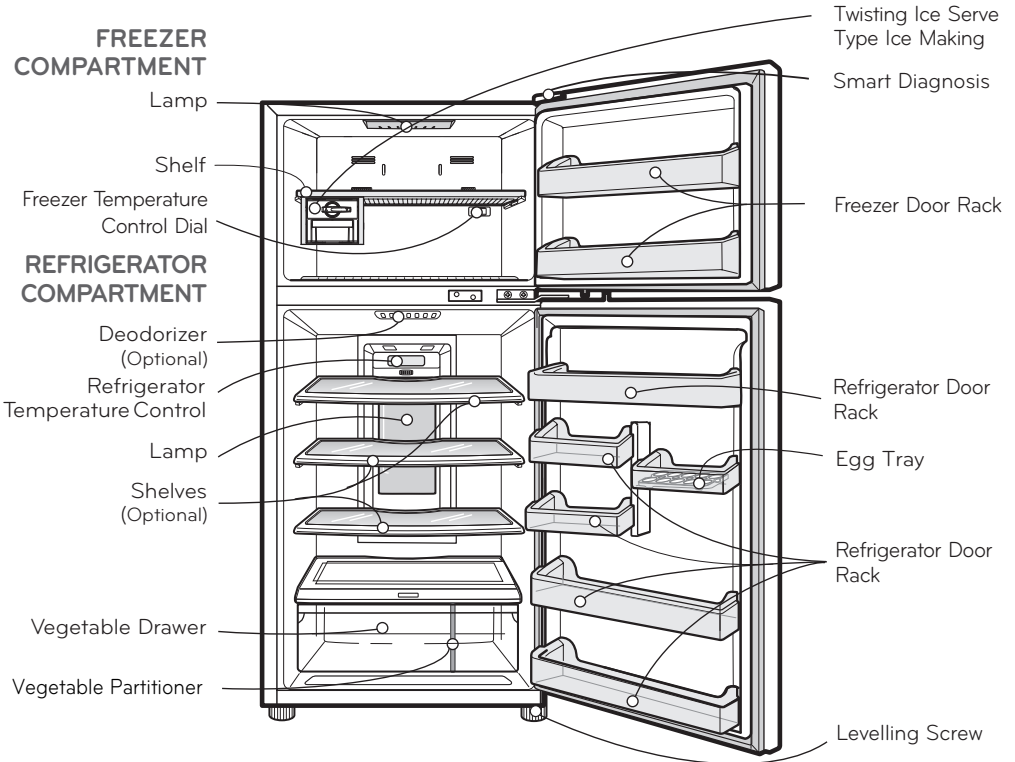

NOTE

- This guide covers several different models. The refrigerator you have purchased may have some or all of the features shown above.

INNER PARTS

DISPENSER MODEL

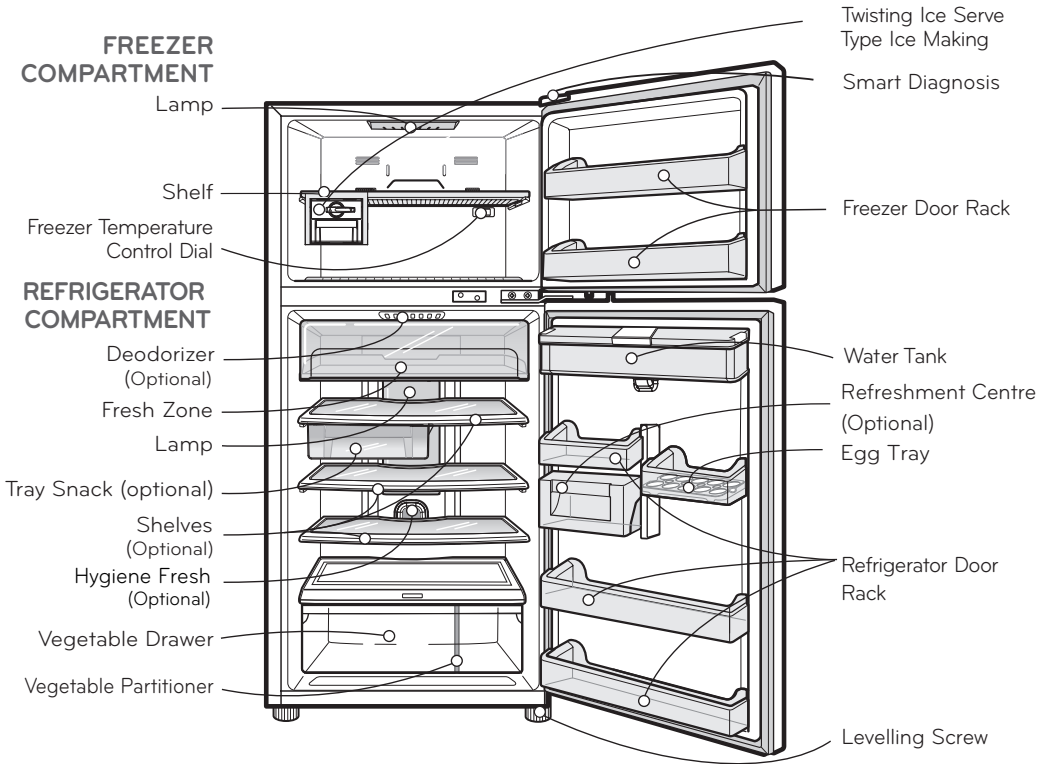

NOTE

- This guide covers several different models. The refrigerator you have purchased may have some or all of the features shown above.

OPERATIONS

STARTING

When your refrigerator is first installed, allow it 3-4 hours to stabilize at normal operating temperatures prior to filling it with fresh or frozen foods.

If operation is interrupted, wait 5 minutes before restarting.

BEFORE SETTING THE TEMPERATURE

- The temperature of the refrigerator is kept constant regardless of changes in room temperature. It is recommended that, once set, the temperature settings (the controls for the refrigerator and freezer compartments) not be changed unless necessary.
- This refrigerator has one temperature control button for the refrigerator compartment and one temperature control dial for the freezer compartment.
- The default setting of the temperature control button for the refrigerator compartment is '3°C'.
- The default setting of the temperature control dial in the freezer compartment is '3'. This dial controls the air flow balance between the Freezer and Refrigerator compartment. It does not control the cycling of the compressor.
- This refrigerator has a temperature sensor in the refrigerator compartment. It will start and stop the compressor automatically as required to meet the target temperature set in the Refrigerator compartment.

DOOR ALARM

When the door of the refrigerator or the freezer is open for 1 minute, an alarm will sound three times. If the door remains open, the alarm will repeat every 30 seconds.

SELF TEST

- Your refrigerator contains a built in diagnostic capability. If it develops a malfunction in certain areas, it will display an error code to assist the repair technician. While an error code is displayed, other control and display functions will not operate.
- If an error code is displayed, contact a service center. Do not disconnect the power cord from the outlet.

CONTROLS FOR REFRIGERATOR COMPARTMENT

FOR INTERNAL CONTROLLER MODEL

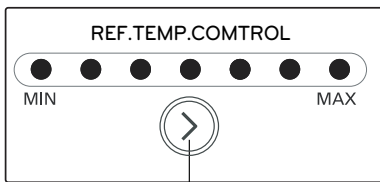

Ref. Temp Control Button

The default setting of the temperature control button for the refrigerator compartment is **NORMAL** (middle LED).

To control the refrigerator target temperature, press the **REF.TEMP CONTROL** button.

Whenever the button is pressed, the LED indicator will increase accordingly.

The temperature is set in 7 steps, from **MIN** to **MAX**. cooling. (**MIN** = warmest, **MAX** = coldest temperature)

OPERATIONS

FOR EXTERNAL CONTROLLER MODEL

Display graphic can be different, depend on the type of your refrigerator.

- Type a

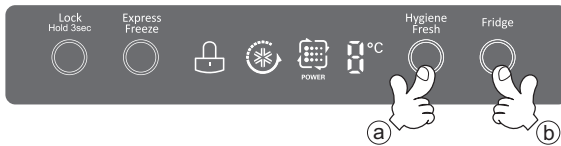

- Type b

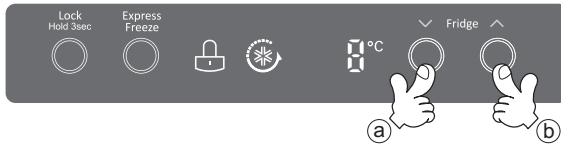

- Press 'Fridge' button to control refrigerator temperature.
- Whenever pressing the button, the LED will indicate the target temperature.
- Press 'Hygiene Fresh' button to operate hygiene motor (optional).
- The number showing on the LED display is the target temperature, not the actual temperature in the refrigerator.
- You can select the desired target temperature, from '0°C' to '6°C'.
 - Type a
 - Press button, Fridge target temperature will reduce in increments of 1°C.
 - Press @ button, Hygiene Fresh motor will be on, power mode, off.
 - Type b
 - Press button, Fridge target temperature will reduce in increments of 1°C.
 - Press button, Fridge target temperature will increase in increments of 1°C.

EXPRESS FREEZE

- The Express Freeze feature operates when the refrigerator first turn on. The compressor and circulating fan operate at maximum cooling capacity to quickly lower the refrigerator temperature. It shuts off automatically.
- If warm food is placed into the refrigerator, Express Freeze can be manually engaged with the button on the control panel. Express Freeze will shut off when the temperature reaches the proper level or it can be shut off manually by pressing the Express Freeze button.



LOCK (OPTIONAL)

- LOCK

Press and hold the Lock button for 3 seconds to engage Lock. When it is locked, the Lock LED will be on and the other buttons will not operate. To unlock, press and hold the Lock button for 3 seconds again.



OPERATIONS

HYGIENE FRESH (OPTIONAL)

⚠ CAUTION

Before installing or using the product, make sure to read the owner's manual carefully to use the product accurately as intended. This HYGIENE FRESH filter has an antibacterial function of removing bacteria inside the refrigerator and a deodorizer function to remove odours.

The function has tested and has been certificated by authorized institutions **Intertek**

- Activating the Hygiene Fresh mode.

- To use the HYGIENE FRESH filter, press the  button on the display panel on the front side of the door and select either the AUTO or POWER mode.
(Whenever you press the button, the HYGIENE FRESH filter will be switched to OFF → AUTO → POWER → OFF.)

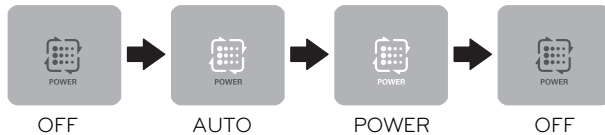

⚠ CAUTION

When the user switches to AUTO or POWER mode, the LED around the filter is also turned on. Open the door to check whether the LED around the filter is also turned on. Do not put in your finger or foreign objects in to the fan. It can cause an injury or malfunction.

⚠ CAUTION

- Do not wash the HYGIENE FRESH filter with water as it can cause a malfunction and will compromise the functions performance.
- This filter may not be effective for all types of bacteria.
- This is effective to remove bacteria which is not on the food in the refrigerator.

OPERATIONS

CONTROLS FOR FREEZER COMPARTMENT

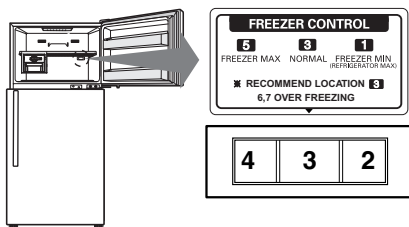

- To lower the temperature in the freezer, turn the knob right and set to a higher number. To raise the temperature in the freezer, turn the knob left and set to a smaller number.
- When the freezer compartment is not cold enough in winter, adjust the control for the freezer to High (6 - 7).
- Knob 7 is for quick freezing in the freezer compartment. The refrigerator can be operated continuously or the refrigerator compartment can be warmer. When the quick freezing is finished, please return to set the Knob at Normal.

- Refrigerator temperature would be warmer when the Freezer temperature set to be colder.

ICE MAKING

Twisting Ice Serve Type

- To make ice cubes, fill the ice tray with water and insert in its position.
- To remove ice cubes, hold the knob of the tray and turn it all the way clockwise until ice cubes drop in the ice cube bin.

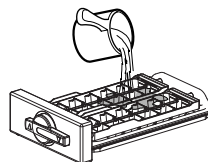

NOTE

You can remove the Ice Maker to secure additional space in the freezer.

- **Twisting Ice Serve Type:** Remove 1 and 2
 1. Ice Tray
 2. Ice Cube Bin.

WARNING

- Do not use anything other than water.
- Fill with water up to the marked line.

Ice Trays
Ice Cube Bin

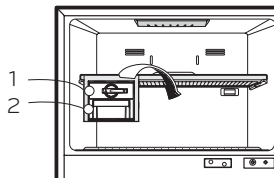
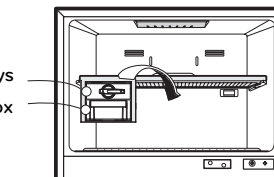

<Twisting Ice Serve Type>

DEFROSTING

- Defrosting takes place automatically.
- The defrosted water from the evaporator flows down to the evaporating tray which is located in the lower back side of the refrigerator and is then evaporated by natural convection.

OPERATIONS

VEGETABLE DRAWER

Vegetable Partitioner

- Fix the partitioner by inserting it at the rear side of vegetable box as shown in the figure.

How to use

- Vegetable drawer humidity & temperature can be changed with the slider control.
- Check the position of the sliding control prior to storing the food.
- Do not set the slider to the middle point.

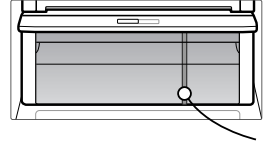

Partitioner

DEODORIZER (OPTIONAL)

- Unpleasant odor of food in the fresh food compartment is deodorized.

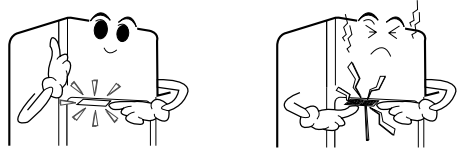

Deodorizer Function

- As the Deodorizer is a passive component, there is no need to move it around as it is located in the optimum place for the best result possible.
- Do not hit or poke at the deodorizer with any object as it may damage it.
- When storing food with a strong odor, wrap it or store it in a container with a lid as the odor may be passed on to other foods.

Re-Using of Deodorizer

- The deodorizer should be cleaned periodically, especially if odors have been present in the refrigerator.
- Remove the Deodorizer from the ceiling of the refrigerator compartment by gently pushing forward on the front clips and lowering the deodorizer body. Soak the deodorizer in warm phosphate based soapy water, then rinse off

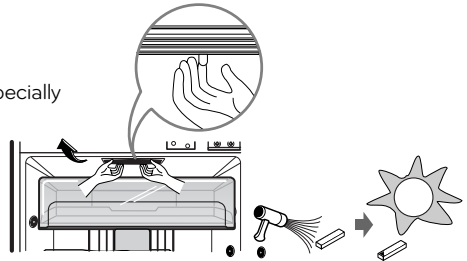

REFRESHMENT CENTER (OPTIONAL)

1. Tilting: Grasp the front pocket and slightly lift it up. Then pull it forward to tilt the transparent door bin.
2. Closing: Then place the door bin in its original position until you hear a "click"

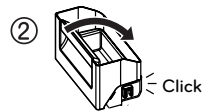
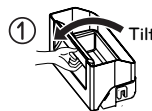

OPERATIONS

WATER DISPENSER (OPTIONAL)

NOTE

- Only fill the water tank after it has been rinsed and installed into position. It should always be removed for cleaning.
- The water tank will will leak when it contains water if it's valve is pushed, even if it is not fitted to the door basket.

• Putting water in the water tank

1. Open the cover cap and pour water into the water tank.

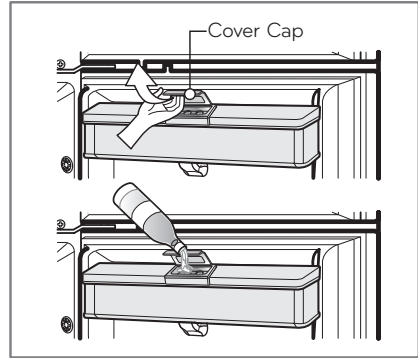

2. Close the cover cap.

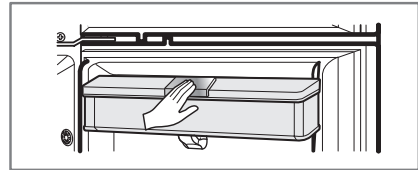

3. The water tank is optional removable part which can be applied to enlarge the storage capacity. You can use the upper basket after removing the water tank. The supplied plug should then be used to cover the hole to protect it from food debris. The plug is enclosed with the egg tray.

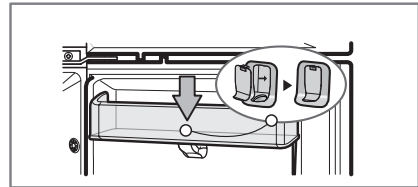

Caution

Do not use anything other than water.
Hot water needs to be cooled before being put in the water tank.

• Dispensing

1. Press the dispenser pad with a cup or glass.
2. The water is released when the dispenser pad is pressed. The pad returns to its original position when the cup or glass is removed and the water stops its flow.



SUGGESTIONS ON FOOD STORAGE

STORING FOOD

- Store fresh food in the refrigerator compartment. How food is frozen and thawed is an important factor in maintaining its freshness and flavor.
- Do not store food which goes bad easily at low temperatures, such as bananas, pineapples, and melons.
- Allow hot food to cool prior to storing. Placing hot food in the refrigerator could spoil other food, and lead to higher electricity bills!
- When storing the food, cover it with vinyl wrap or store in a container with a lid. This prevents moisture from evaporating, and helps food to keep its taste and nutrients.
- Do not block air vents with food. Smooth circulation of chilled air keeps refrigerator temperatures even.
- Do not open the door frequently. Opening the door lets warm air enter the refrigerator, and causes temperatures to rise.

FREEZER COMPARTMENT

- Do not store bottles in the freezer compartment - they may break or explode when frozen.
- Do not refreeze food that has been thawed. This causes loss of taste and nutrition.
- When storing frozen food like ice cream for a long period, place it on the freezer shelf, not in the door rack.
- It is recommended to load food at least 11mm away from the back of freezer wall, this will allow good air circulation in the freezer compartment.
- Loading the Freezer - It is recommended to load newly introduced foods in the following freezer location for freezing:

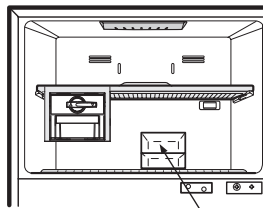

Newly Introduced Food

REFRIGERATOR COMPARTMENT

- Avoid placing moist food deeply positioned on the refrigerator shelf, it could freeze upon direct contact with chilled air. To avoid this it is better to store food in a covered container.
- It is desirable to store moist food (especially vegetable and fruit) in the vegetable storage compartment. If it is necessary to store on a shelf of the refrigerator, put it close to the door away from the back wall of the refrigerator to avoid being frozen by the cool circulating air in the refrigerator.
- Always clean food prior to refrigeration. Vegetables and fruits should be washed and wiped, and packed food should be wiped clean, to prevent adjacent food from spoiling.
- When storing eggs in their storage rack, ensure that they are fresh, and always store them in a up-right position, which keeps them fresh longer.

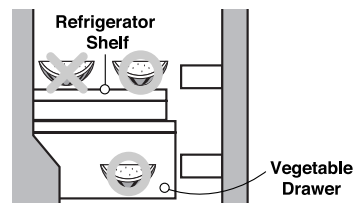

CLEANING

It is important that your refrigerator be kept clean to prevent undesirable odors. Spilled food should be wiped up immediately, since it may acidify and stain plastic surfaces if allowed to settle.

Never use metallic scouring pads, brushes, coarse abrasive cleaners or strong alkaline solutions on any surface.

Before you clean, remember that damp objects will stick or adhere to extremely cold surfaces. Do not touch frozen surfaces with wet or damp hands.

EXTERIOR - Use a lukewarm solution of mild soap or dish washable solution to clean the durable finish of your refrigerator. Wipe with a clean, damp cloth and then dry.

INTERIOR - Regular cleaning of the interior and interior parts is recommended. Use a lukewarm solution of mild soap or dish washable solution to clean the inner lining of your refrigerator. Wipe with a clean, damp cloth and then dry.

INTERIOR PARTS - Wash compartment shelves, door racks, storage trays and magnetic door seals etc. Using a lukewarm solution of mild soap or dish washable solution to clean the inner lining of your refrigerator. Wipe with a clean damp cloth and then dry.

WARNING

Always remove power cord from the wall outlet prior to cleaning in the vicinity of electrical parts (lamps, switches, controls, etc.). Wipe up excess moisture with a sponge or cloth to prevent water or liquid from getting into any electrical part and causing electric shock. Do not use flammable or toxic cleaning liquids.

- Do not use : Surface active agents, Car wax, Anticorrosive, or any kind of oil, Gasoline, Acids, Wax.
- Only use dish washable solution, and soapy water when cleaning.
- Using harsh cleaning chemicals will cause the external finishes to change colour.

CLEANING

WATER DISPENSER

Grille -

Wipe with a wet cloth, and dry with a dry cloth.

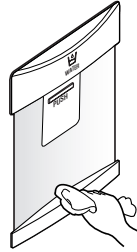

Water Tank -

1. Putting the Water

It is not necessary to remove the tank to fill it with water. (it could be filled like shows fig. 1 pulling the tank gate).

NOTE

- Before closing door, close the water cap to prevent water from spilling out.
- Do not use liquids containing sugar or carbonated drinks like soda

2. Disassembly

Lift the water tank, gripping it from the sides then from the bottom of the tank.

NOTE

When removing the Water Tank, dispense all the water from the dispenser first.

3. Assembly

Refit the water tank by aligning it with the basket and slowly lowering it into the correct position, ensuring that the valve is pushed down snugly into the outlet hole of the door.

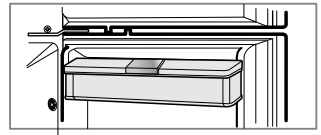
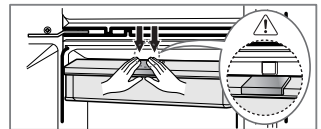
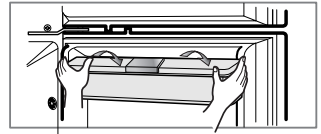
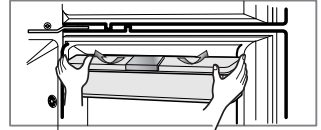

Cleaning the Water Tank -

1. Remove the water tank as per the Disassembly instructions then remove the tank cover.

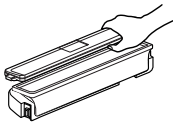

2. Clean the inside and outside of the water tank with dishwashing detergent and rinse thoroughly under warm running water. Dry the water with a cloth.

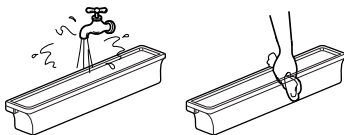

3. Clean the inside and outside of the cap with dishwashing detergent and rinse thoroughly under warm running water. Dry the water with a cloth.

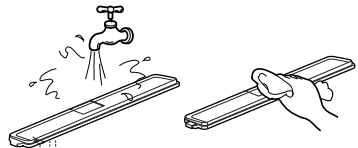

Caution

1. Use lukewarm water when cleaning.
2. Do not use anything other than water.

GENERAL INFORMATION

VACATION TIME

During average length vacations, you will probably find it best to leave the refrigerator in operation.

Place freezable items in freezer for longer life.

When you plan to be away for an extended period, remove all food, disconnect the power cord, clean the interior thoroughly, and leave each door OPEN to prevent odor formation.

POWER FAILURE

Most power failures are corrected in an hour or two and will not affect your refrigerator temperatures.

However, you should minimize the number of door openings while the power is off. During power failures of longer duration, place a block of dry ice on top of your frozen packages.

IF YOU MOVE

Remove or securely fasten down all loose items inside the refrigerator.

To avoid damaging the leveling screw(s), turn them all the way into the base.

This appliance is intended to be used in normal domestic household and similar applications such as:

- Staff kitchen areas in offices and other working environments.
- By clients in hotels, motels and other residential type environments.

ANTI-CONDENSATION PIPE

The outside wall of the refrigerator cabinet may sometimes get warm, especially just after installation.

Don't be alarmed.

This is due to the anti-condensation pipe, which pumps hot refrigerant to prevent "sweating" on the outer cabinet wall.

Do not attach any fixture to the refrigerator by drilling, gluing or screwing into it.

Anti-Condensation Pipe

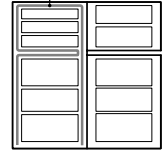

Caution

Electrical Shock Hazard

Before replacing a burned-out light bulb, either unplug the refrigerator or turn off power at the circuit breaker or fuse box.

NOTE :Moving the control to the OFF position does not remove power to the light circuit.

LAMP REPLACEMENT

NOTE

- This product uses an LED Lamp which can not be replaced by the user. Please contact authorized service centre for the lamp replacement.

IMPORTANT WARNINGS

DO NOT USE AN EXTENSION CORD

If possible, connect the refrigerator to its own individual electrical outlet to prevent it and other appliances or household lights from causing an overload that could cause a power outage.

ACCESSIBILITY OF SUPPLY PLUG

The refrigerator-freezer should be positioned so that the supply plug is accessible for quick disconnection should an accident happen

SUPPLY CORD REPLACEMENT

If the supply cord is damaged, it must be replaced by the manufacturer or its service agent or a similarly qualified person in order to avoid a hazard.

ABOUT GROUNDING (EARTHING)

In the event of an electric short circuit, grounding (earthing) reduces the risk of electric shock by providing an escape wire for the electric current.

In order to prevent possible electric shock, this appliance must be earthed via the mains plug in accordance to the Australian Standards

Improper use of the mains power plug can result in an electric shock. Consult a qualified electrician or service person if the grounding instructions are not completely understood, or if you have doubts on whether the appliance is properly grounded.

DO NOT MODIFY OR EXTEND THE POWER CORD LENGTH.

It will cause electric shock or fire.



VERY DANGEROUS ATTRACTION

An empty refrigerator can be a dangerous attraction to children. Remove either gaskets, latches, lids or the entire door from your unused appliance, or take some other action to make it harmless.

Do not store flammable materials, explosives or chemicals in the refrigerator.

WARNING

This appliance is not intended for use by person (including children) with reduced physical, sensory or mental capabilities, or lack of experience and knowledge, unless they have been given supervision or instruction concerning use of the appliance by a person responsible for their safety.

Children should be supervised to ensure that they do not play with the appliance.

DISPOSAL OF THE OLD APPLIANCE

This appliance contains fluid (refrigerant, lubricant) and is made of parts and materials which are reusable and/or recyclable.

When disposing any appliance, always call your local council for advise or possible collection options.

BEFORE CALLING FOR SERVICE

SERVICE CALLS CAN OFTEN BE AVOIDED!

IF YOU FEEL YOUR REFRIGERATOR IS NOT OPERATING PROPERLY, CHECK THESE POSSIBLE CAUSES FIRST :

PROBLEM	POSSIBLE CAUSES
REFRIGERATOR DOES NOT OPERATE	<ul style="list-style-type: none"> • Has a house fuse blown or circuit breaker tripped? • Has the power cord plug been removed or loosened from the electrical wall outlet?
REFRIGERATOR OR FREEZER COMPARTMENT TEMPERATURE TOO WARM	<ul style="list-style-type: none"> • Temperature control not set on proper position. • Appliance is placed close to wall or heat source. • Warm weather-frequent door openings. • Door left open for a long time. • Large amount of foods are kept in the refrigerator.
ABNORMAL NOISE(S)	<ul style="list-style-type: none"> • Refrigerator is installed in a weak or uneven place, or leveling the front feet may be necessary. • Unnecessary objects placed in or on the rear side of the refrigerator.
REFRIGERATOR HAS ODOR	<ul style="list-style-type: none"> • Foods with strong odors should be tightly covered or wrapped. • Interior or deodorizer needs cleaning.
DEW FORMS ON THE CABINET OR INSIDE SURFACE	<ul style="list-style-type: none"> • Not unusual during periods of high humidity. • Door may have been left ajar.
NO INTERIOR LIGHTING	<ul style="list-style-type: none"> • This unit uses led lighting. It cannot be serviced or replaced by the owner. Call the manufacturer for service options.

SMART DIAGNOSIS (Only for applied models)

☐ FOR INTERNAL CONTROLLER MODEL

Smart diagnosis function is...



Use this function when calling the Customer Call Centre and receive precise diagnosis when the refrigerator malfunctions or fails. Use it only when advised by the consultant and not otherwise.

How to use the function

1. Open all the doors of the refrigerator.
2. Press the refrigerator door open detection switch 5 times as in the figure to make the light inside the compartment blink.
3. Place the phone near the speaker hole in the top right hand side door hinge

Ensure the microphone of the telephone is toward the speaker hole.

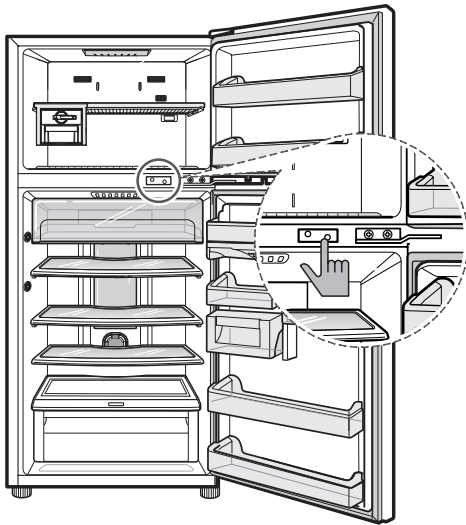

4. Do not take away the telephone while data is being transmitted.
- During the data transmission for smart diagnosis, hold the telephone 10cm away from the speaker hole and avoid any background noises.

⚠ CAUTION

The transmission sound may be irritating.
Do not take away the telephone until the sound stops.

5. After the completion of the data transmission, the consultant will explain the result of the smart diagnosis and advise accordingly.
- When the data transmission is completed, the refrigerator will be automatically turned off and on a few seconds later.

Be aware!

- Differences of regional call qualities may have influence on the function.
- If you use a home phone, better communication performance will enable much better service.
- Smart diagnosis data transmission may not be successful if the call is made from a mobile phone with poor cell reception

SMART DIAGNOSIS (Only for applied models)

☐ FOR EXTERNAL CONTROLLER MODEL

Smart diagnosis function is...



Use the function to contact the service center and receive precise diagnosis when the refrigerator malfunctions or fails. Use it only to connect to the consultant and do not use it in normal times.

How to use the function

1. Close all refrigerator doors, and press and hold display lock button to make it locked state.
If the display is already in locked state, press and hold lock button to reset the lock and press and hold the lock button again to make it locked state.

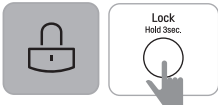

⚠ Caution

- If it passes 5 minutes in locked state, smart diagnosis function will not be activated, so be careful.

2. Press and hold fridge temperature button for 3 seconds or longer.
(All display screens will be turned off, and in a while, 3 will be displayed on the fridge temperature display part.)

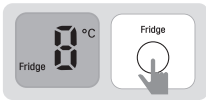

< Model with Hygiene Fresh Filter >

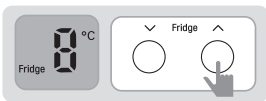

< Model without Hygiene Fresh Filter >

3. Open all refrigerator compartment and freezer compartment doors, and place the telephone near the speaker hole at the top right side.

Check if the speaking side(microphone) of the telephone is toward the speaker hole.



4. Do not take away the telephone while data is being transmitted.

During the data transmission for smart diagnosis, wait with the telephone placed near the speaker hole at the top right side.

The remaining time for data transmission is displayed on the display screen.

⚠ Caution

- The transmission sound may be irritating. Do not take away the telephone until the sound stops for good diagnosis.

5. After the completion of the data transmission, listen to the explanation of the consultant about the result of the smart diagnosis.

When the data transmission is completed, along with the display of the data transmission completion, the refrigerator will be automatically turned off and on a few seconds later.

Listen to the explanation of the consultant about the result of the analyzed diagnosis and follow the instructions.

Be aware!

- Difference of the regional call qualities may have influence on the function.
- If you use home phone, better communication performance will enable much better service.
- Smart diagnosis data transmission may not be fluent due to call quality problem, and in such case, smart diagnosis service may be difficult.

