



**LG**

Life's Good

## OWNER'S MANUAL

# MONITOR SIGNAGE

Please read this manual carefully before operating the your set and retain it for future reference.

### MONITOR SIGNAGE MODELS

42WT30MS

47WT30MS

55WT30MS

# TABLE OF CONTENTS

## 4 LICENSES

---

## 5 ASSEMBLING AND PREPARING

---

- 5 Accessories
- 6 Optional Accessories
- 7 Parts and Buttons
- 8 Connecting the Speaker
- 9 Using the Mounting Cable Tie
- 10 Using the IR Receiver
- 10 Portrait Layout
- 11 Mounting on a Wall

## 13 REMOTE CONTROL

---

## 15 USING THE MONITOR

---

- 15 Connecting to a PC
- 15 - RGB Connection
- 16 - DVI Connection
- 16 - HDMI Connection
- 17 - Display Port Connection
- 17 - IR Receiver Connection
- 18 - Touch USB Cable Connection
- 19 Adjusting the Screen
- 19 - Selecting an Image Mode
- 19 - Customizing Image Options
- 20 - Customizing PC Display Options
- 20 Adjusting the Sound
- 20 - Selecting an Sound Mode
- 21 - Customizing Sound Options
- 21 Using Additional Options
- 21 - Using the Input List
- 22 - Adjusting Aspect Ratio

## 24 ENTERTAINMENT

---

- 24 - Using the Network
- 24 - Connecting to a Wired Network
- 25 - Network Status
- 26 - Using the My Media
- 26 - Connecting USB Storage Device
- 28 - Browsing Files
- 30 - Viewing movies
- 33 - Viewing photos
- 36 - Listening to music
- 38 - Viewing the Contents List
- 39 - DivX® VOD Guide
- 40 - Using PIP/PBP

## 41 CUSTOMIZING SETTINGS

---

- 41 Accessing Main Menus
- 42 - PICTURE Settings
- 45 - AUDIO Settings
- 46 - TIME Settings
- 47 - OPTION Settings
- 51 - Picture ID Settings
- 52 - NETWORK Settings

## 53 MAKING CONNECTIONS

---

- 54 External Device Connection
- 54 - AV (CVBS) Connection
- 54 - COMPONENT Connection
- 55 - HDMI Connection
- 55 - DVI Connection
- 56 USB Connection
- 56 LAN Connection

## **57 USING THE TOUCH SCREEN**

---

- 57 To Use the Touch Screen on Windows 7
- 57 Gestures and Settings on Windows 7
- 58 To Use the Touch Screen on Windows XP
- 59 Touch Response to Windows XP
- 60 How to Use LG TDS
- 60 LG TDS Detailed Function Settings
- 61 Precautions When Using the Touch Screen

## **62 TROUBLESHOOTING**

---

## **67 SPECIFICATIONS**

---

## **77 IR CODES**

---

## **78 CONTROLLING THE MULTIPLE PRODUCT**

---

- 78 Connecting the Cable
- 78 RS-232C Configurations
- 78 Communication Parameter
- 79 Command Reference List
- 81 Transmission / Receiving Protocol

# LICENSES

Supported licenses may differ by model. For more information of the licenses, visit [www.lg.com](http://www.lg.com).



The terms HDMI and HDMI High-Definition Multimedia Interface, and the HDMI logo are trademarks or registered trademarks of HDMI Licensing LLC in the United States and other countries.



**ABOUT DIVX VIDEO:** DivX® is a digital video format created by DivX, LLC, a subsidiary of Rovi Corporation. This is an official DivX Certified® device that plays DivX video. Visit [divx.com](http://divx.com) for more information and software tools to convert your files into DivX videos.

**ABOUT DIVX VIDEO-ON-DEMAND:** This DivX Certified® device must be registered in order to play purchased DivX Video-on-Demand (VOD) movies. To obtain your registration code, locate the DivX VOD section in your device setup menu. Go to [vod.divx.com](http://vod.divx.com) for more information on how to complete your registration.

DivX Certified® to play DivX® video up to HD 1080p, including premium content.

DivX®, DivX Certified® and associated logos are trademarks of Rovi Corporation or its subsidiaries and are used under license.

Covered by one or more of the following U.S. patents: 7,295,673; 7,460,668; 7,515,710; 7,519,274



Manufactured under license from Dolby Laboratories. Dolby and the double-D symbol are trademarks of Dolby Laboratories.

## ! NOTE

- The warranty will not cover any damages caused by using the product in an excessively dusty environment.
- Avoid using the product in a high temperature and high humidity area. Moving the monitor from a environment like this to an air conditioned area may cause moisture formation inside the glass. This moisture will be dissipate over time, which may vary depending on the operating environment.

# ASSEMBLING AND PREPARING

## Accessories

Check your product box for the following items. If there are any missing accessories, contact the local dealer where you purchased your product. The illustrations in this manual may differ from the actual product and accessories.

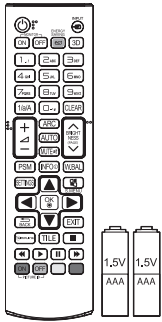

**Remote Control and Batteries**

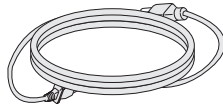

**Power Cord**

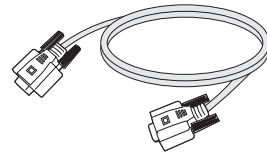

**D-sub 15-pin Signal Cable**

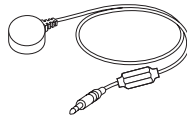

**IR Receiver**

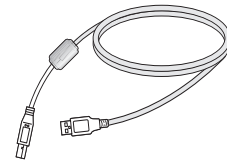

**USB Cable**



**CD (Owner's Manual, SuperSign Program/ Manual)/ Cards**

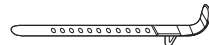

**Mounting Cable Tie**



### CAUTION

- Do not use any pirated items to ensure the safety and product life span.
- Any damages or injuries by using pirated items are not covered by the warranty.



### NOTE

- The accessories supplied with your product may vary depending on the model.
- Product specifications or contents in this manual may be changed without prior notice due to upgrade of product functions.

## Optional Accessories

Without prior notice, optional accessories are subject to change to improve the performance of the product, and new accessories may be added. The illustrations in this manual may differ from the actual product and accessories.

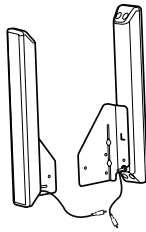

**Speaker  
SP-2100**



**Cable holder/  
Cable Tie**

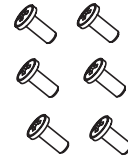

**Screws**  
Diameter 4.0 mm x  
Pitch 1.6 mm x Length  
10 mm

### Speaker Kit

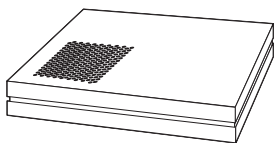

**NC1000/NC1100  
NA1000/NA1100  
Media Player**



**Screws**



**CD(Owner's Manual)/  
Cards**

### Media Player Kit

#### **NOTE**

- Cable holder/cable tie may not be available in some areas or for some models.
- Optional accessories are not included for all models.

## Parts and Buttons

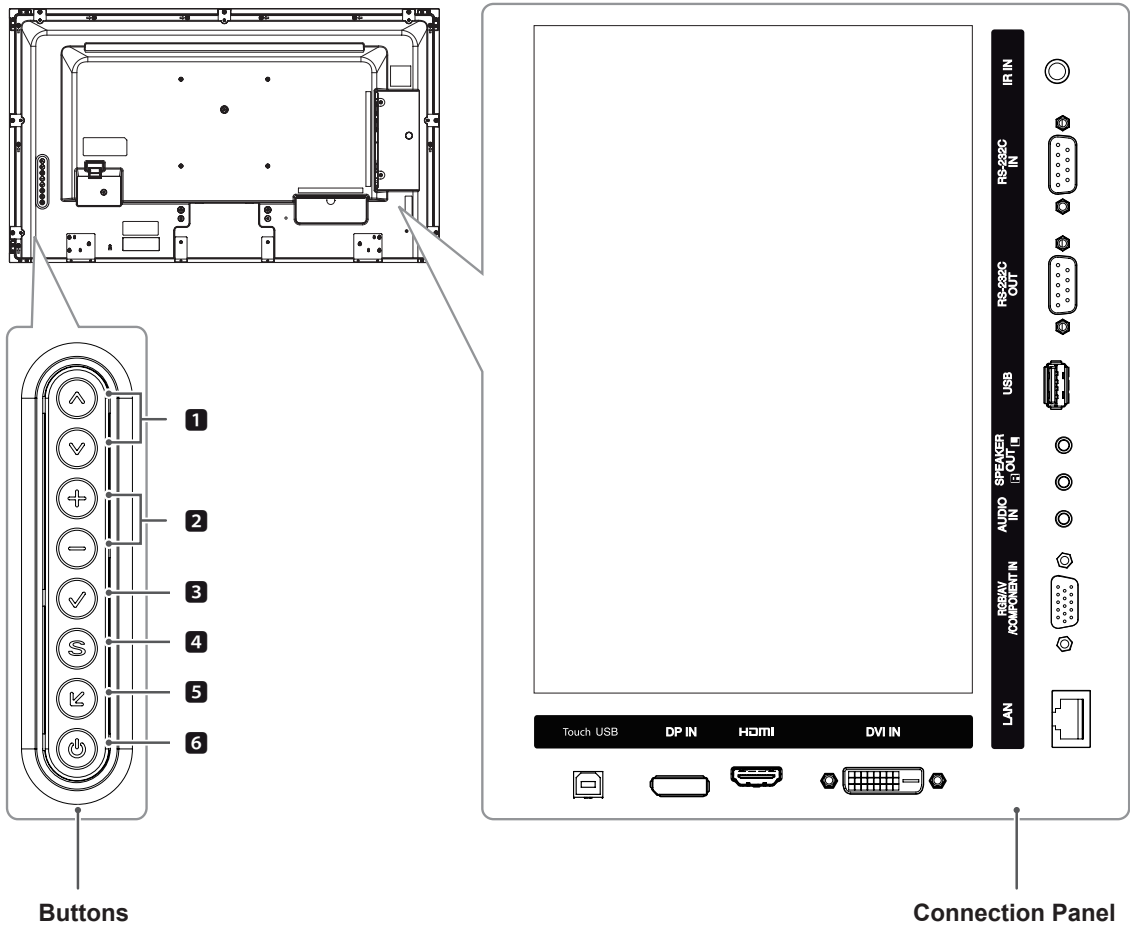

No.	Description
<b>1</b>	Moves the selection up and down.
<b>2</b>	Adjusts the volume level.
<b>3</b>	Displays the current signal and mode. Press this button to adjust the screen automatically (available only in RGB mode)
<b>4</b>	Accesses the main menus, or saves your input and exits the menus.
<b>5</b>	Changes the input source.
<b>6</b>	Turns the power on or off.

## Connecting the Speaker

- Only on some models.

- 1 Connect the input signal cable to the monitor before installing the speakers. Use a cable tie to organize the cables.

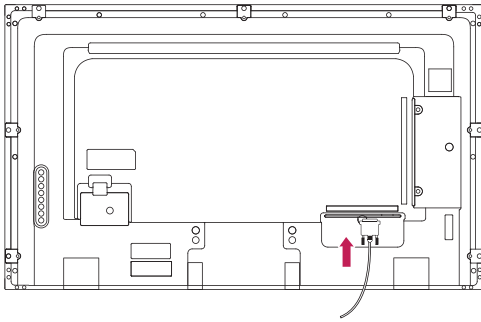

- 3 Mount the speaker by using a screw as shown in the following. Make sure the power cable is disconnected.

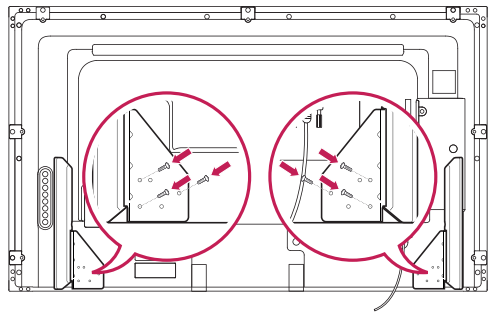

- 2 Remove the 6 screws before assembling the speakers.

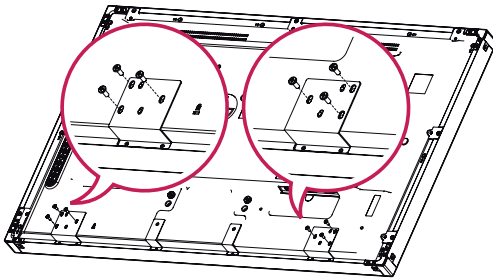

- 4 Then connect the speaker cable. After installing your speakers, use holders and cable ties to organize the speaker cables.

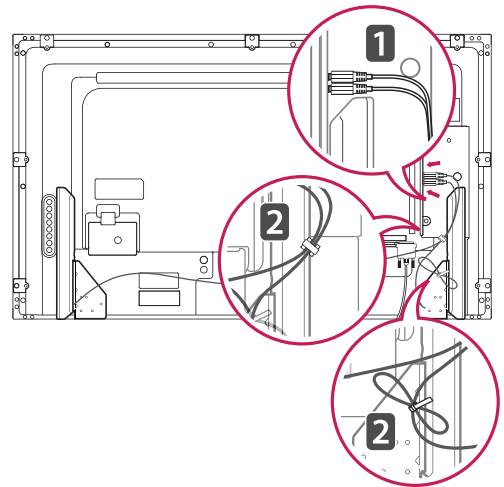



## Using the Mounting Cable Tie

First, connect the input signal cable to be used. Insert the cable tie into the bottom hole on the back as shown in the figure to organize cables.

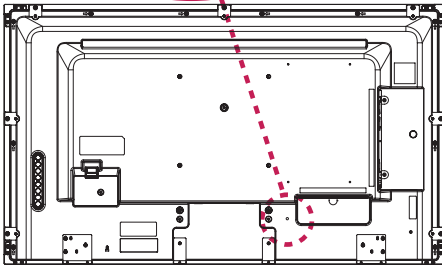
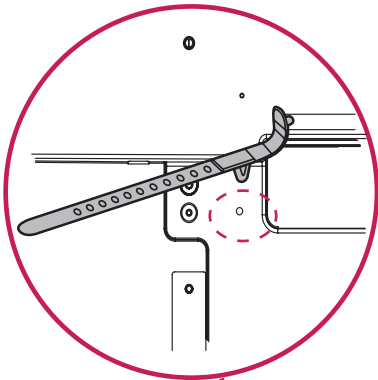
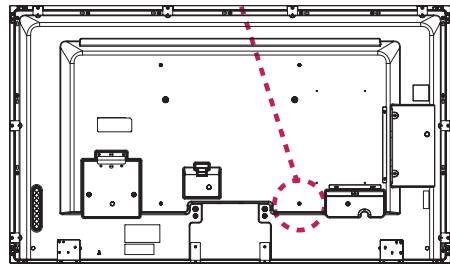
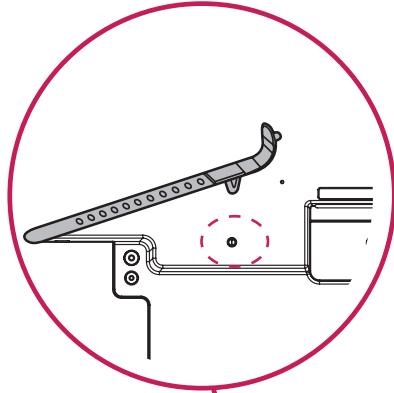
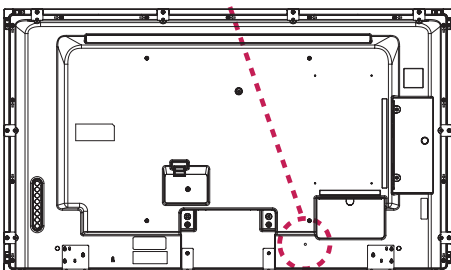
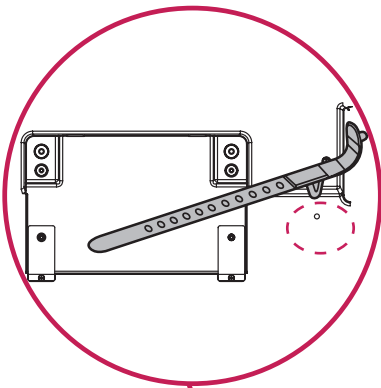
**42WT30MS****55WT30MS****47WT30MS**

## Using the IR Receiver

This allows a remote control sensor to be placed in a custom location. It is recommended to attach it to the location illustrated in the figure below.

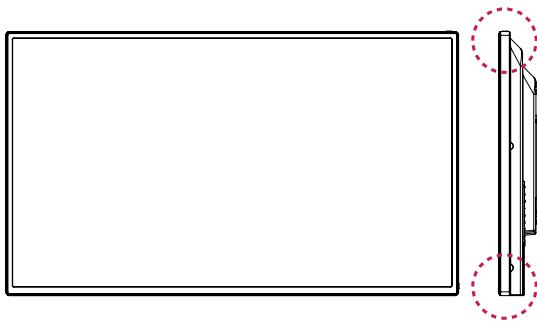

## Portrait Layout

To install in portrait mode, rotate the set counterclockwise 90 degrees when looking from the front.

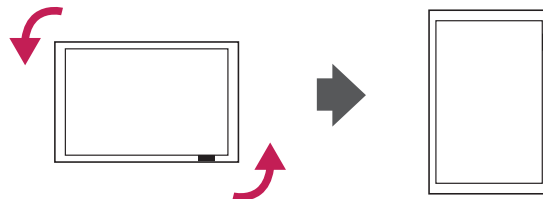

### NOTE

- Do not attach the IR receiver to the surface of the monitor or within 50 cm of it in any direction.

## Mounting on a Wall

For proper ventilation, allow a clearance of 10 cm on each side and from the wall. Detailed installation instructions are available from your dealer, see the optional Tilt Wall Mounting Bracket Installation and Setup Guide.

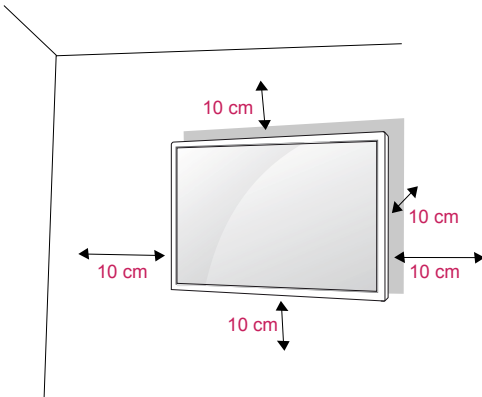

If you intend to mount the monitor to a wall, attach a wall mounting interface (optional parts) to the back of the set.

When you install the monitor using a wall mounting interface (optional parts), attach it carefully so it will not fall.

- 1 Please, use a wall mount and screws in accordance with VESA Standards.
- 2 If you use screws longer than standard, the monitor might be damaged internally.
- 3 If you use improper screws, the product might be damaged and drop from mounted position. In this case, LG Electronics is not responsible for damage.
- 4 Please use VESA standard as below.
  - 785mm or greater
  - \* Fastening screw: Diameter 6.0 mm x Pitch 1.0 mm x Length 12 mm

### CAUTION

- Disconnect the power cord first, and then move or install the monitor set. Otherwise electric shock may occur.
- If you install the monitor set on a ceiling or slanted wall, it may fall and result in severe injury.
- Use an authorized LG wall mount and contact the local dealer or qualified personnel.
- Do not over tighten the screws as this may cause damage to the monitor set and void your warranty.
- Use the screws and wall mounts that meet the VESA standard. Any damages or injuries by misuse or using an improper accessory are not covered by the warranty.
- To prevent injury, this apparatus must be securely attached to the wall in accordance with the installation instructions. (This only pertains to Australia and New Zealand.)

### NOTE

- The wall mount kit includes an installation manual and necessary parts.
- The wall mount bracket is optional. You can obtain additional accessories from your local dealer.
- The length of screws may differ depending on the wall mount. Be sure to use the proper length.
- For more information, refer to the instructions supplied with the wall mount.

**Securing the product to a wall (optional)**

(Depending on model)

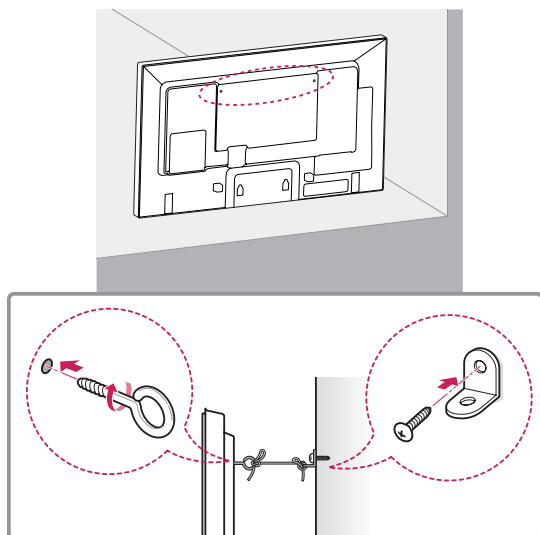

- 1 Insert and tighten the eye-bolts, or product brackets and bolts on the back of the product.  
- If there are bolts inserted at the eye-bolts position, remove the bolts first.
- 2 Mount the wall brackets with the bolts to the wall.  
Match the location of the wall bracket and the eye-bolts on the rear of the product.
- 3 Connect the eye-bolts and wall brackets tightly with a sturdy rope.  
Make sure to keep the rope horizontal with the flat surface.

**CAUTION**

- Make sure that children do not climb on or hang on the product.

**NOTE**

- Use a platform or cabinet that is strong and large enough to support the product securely.
- Brackets, bolts and ropes are optional. You can obtain additional accessories from your local dealer.

**WARNING**

- If a product is not positioned in a sufficiently stable location, it can be potentially hazardous due to falling. Many injuries, particularly to children, can be avoided by taking simple precautions such as:
  - » Using cabinets or stands recommended by the manufacturer of the product.
  - » Only using furniture that can safely support the product.
  - » Ensuring the product is not overhanging the edge of the supporting furniture.
  - » Not placing the product on tall furniture (for example, cupboards or bookcases) without anchoring both the furniture and the product to a suitable support.
  - » Not standing the product on cloth or other materials placed between the product and supporting furniture.
  - » Educating children about the dangers of climbing on furniture to reach the product or its controls.

# REMOTE CONTROL

The descriptions in this manual are based on the buttons of the remote control. Please read this manual carefully and use the monitor set correctly.

To replace batteries, open the battery cover, replace batteries (1.5 V AAA) matching ⊕ and ⊖ ends to the label inside the compartment, and close the battery cover.

To remove the batteries, perform the installation actions in reverse.

**CAUTION**

- Do not mix old and new batteries, as this may damage the remote control.
- Make sure to point the remote control to the remote control sensor on the monitor set.

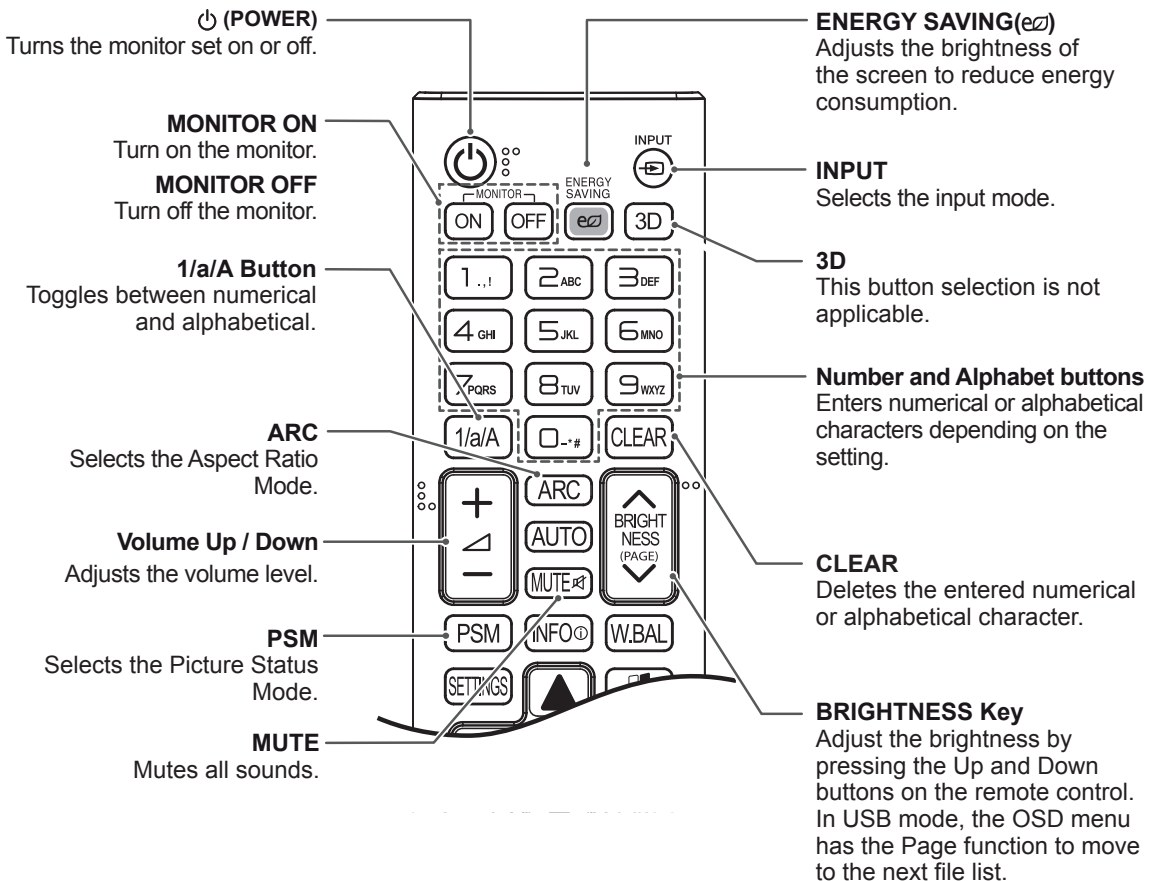
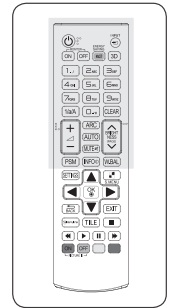
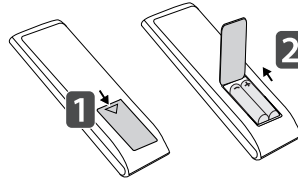

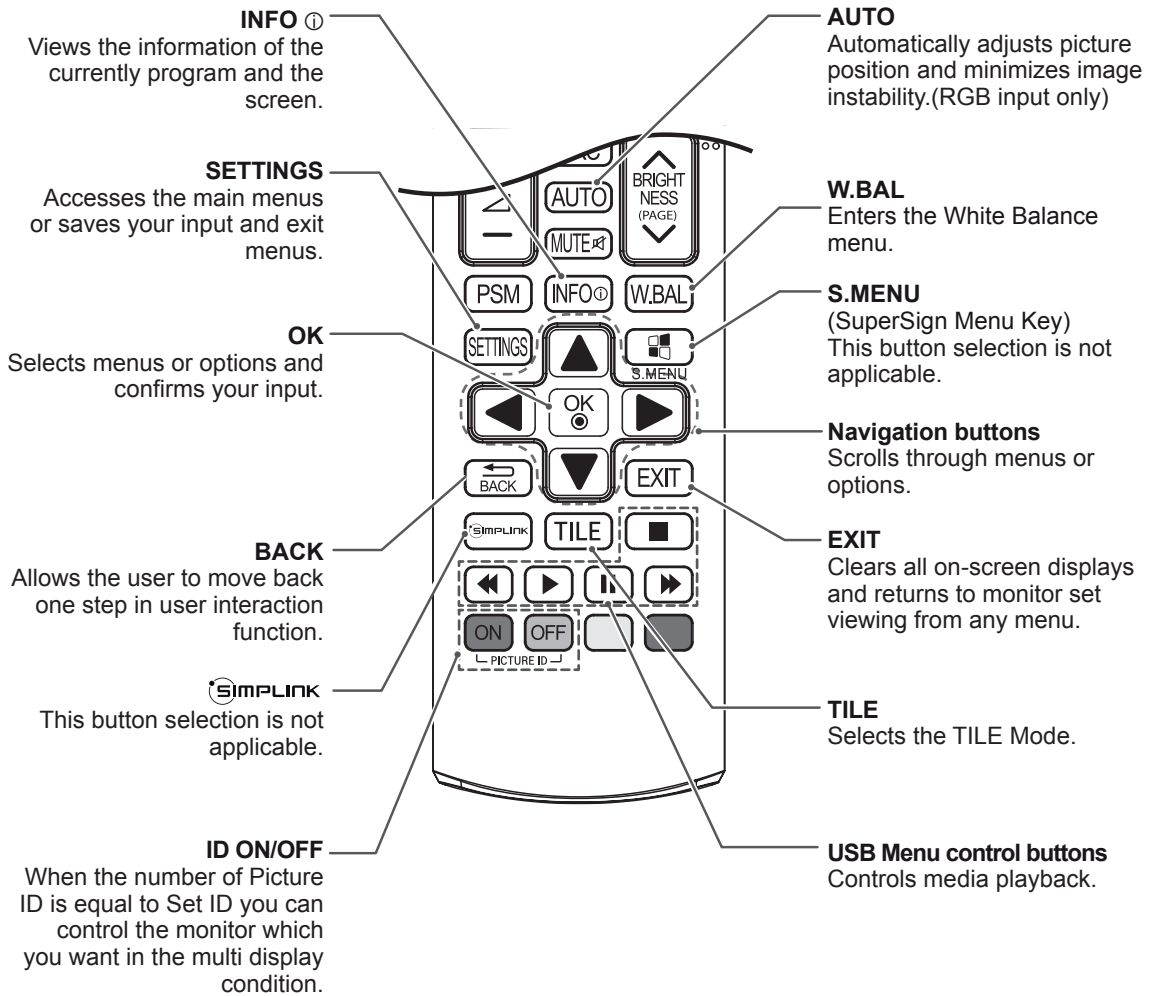
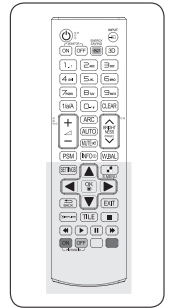

# USING THE MONITOR

## Connecting to a PC

Your monitor supports the Plug & Play\* feature.

\* Plug & Play: A PC will have a built-in driver for the monitor; no extra software is needed.

### NOTE

- It is recommended you use an HDMI connection for the best image quality.
- Use a shielded signal interface cable, such as D-sub 15-pin signal cable and DVI/HDMI cable, with a ferrite core to maintain standard compliance for the product.
- If you turn the monitor set on when the set is cold, the screen may flicker. This is normal.
- Some red, green, or blue spots may appear on the screen. This is normal.
- If you use a cable longer than the D-sub 15-pin signal cable provided, certain images may appear blurry.

### CAUTION

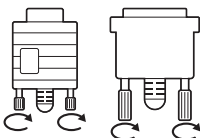

- Connect the signal input cable and tighten it by turning the screws clockwise.
- Do not press the screen with your finger for a long time as this may result in temporary distortion on the screen.
- Avoid displaying a fixed image on the screen for a long period of time to prevent image burn. Use a screensaver if possible.

## RGB Connection

Transmits an analog video signal from your PC to the monitor. Connect the PC and the monitor with the 15-pin signal cable as shown in the following illustration. Select RGB input. To transmit an audio signal, connect an optional audio cable.

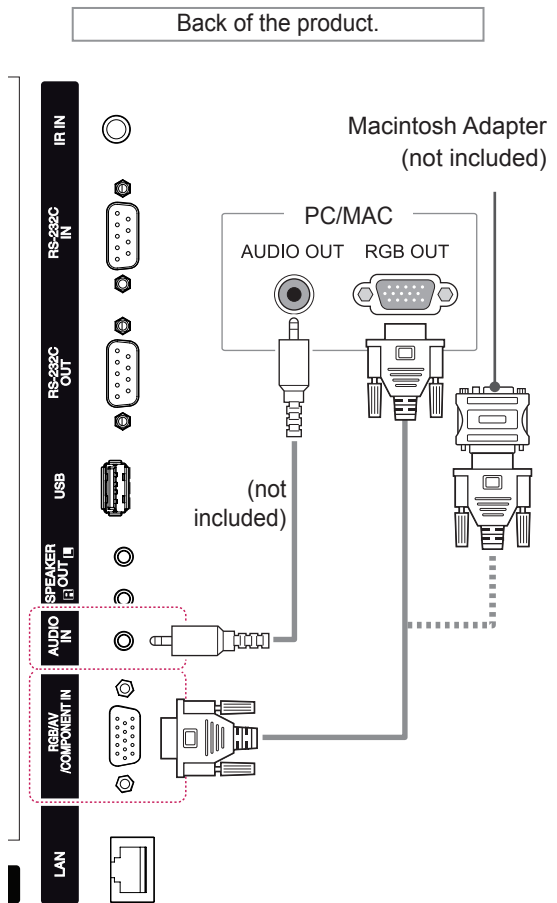

### NOTE

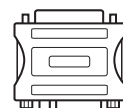

- Use the standard Macintosh adapter since an incompatible adapter is available in the market. (Different signaling system)
- Apple computers may require an adapter to connect to this monitor. Call or visit their web site for more information.

## DVI Connection

Transmits a digital video signal from your PC to the monitor. Connect the PC and the monitor with a DVI cable as shown in the following illustration. Select DVI input. To transmit an audio signal, connect an optional audio cable.

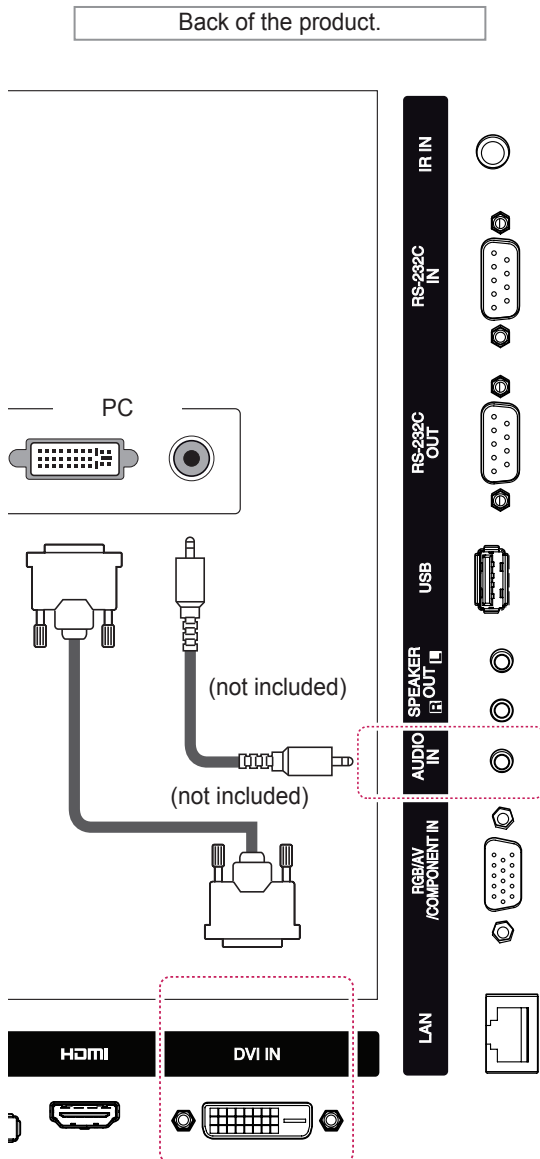

## HDMI Connection

Transmits the digital video and audio signals from your PC to the monitor. Connect the PC and the monitor with an HDMI cable as shown in the following illustration. Select HDMI input.

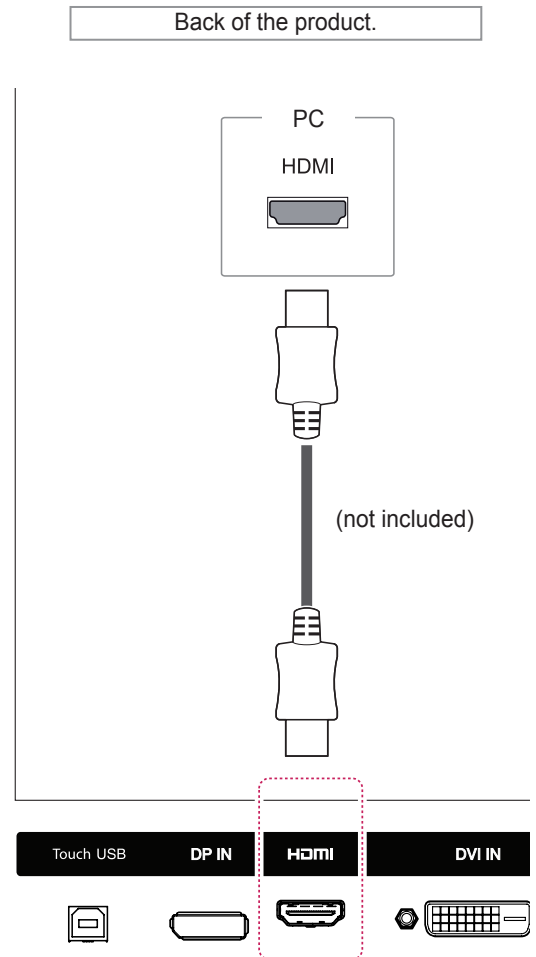

### NOTE

- Use a High Speed HDMI™ Cable.
- Please check the PC environment if you cannot hear audio in HDMI mode. Some PCs require you to manually change the default audio output to HDMI.
- If you want to use HDMI-PC mode, you must set the input label to PC mode.
- When HDMI PC is used, a compatibility problem might occur.



## Display Port Connection

Transmits the digital video and audio signals from your PC to the monitor. Connect the PC and the monitor with a Display Port cable as shown in the following illustrations. Select Display Port input source.

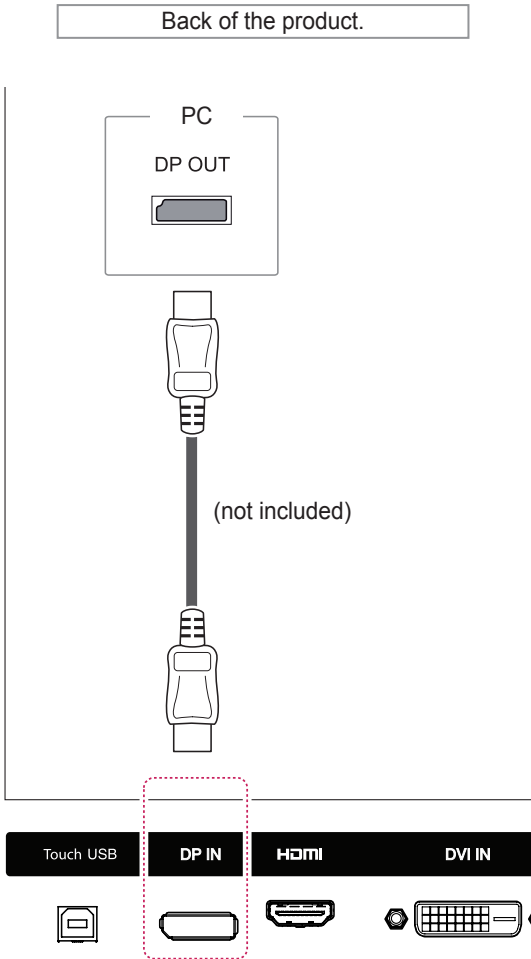

## IR Receiver Connection

Allows the use of a wired remote or IR receiver extension.

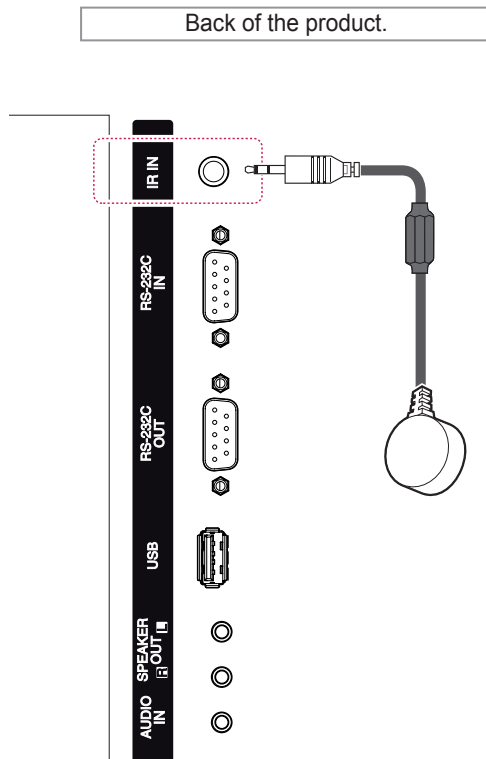

**NOTE**

- Make sure the power cable is disconnected.
- Installing the IR receiver on the front or upper part of the product may cause interference with the TOUCH IR. Install the IR receiver on the back of the product.

## Touch USB Cable Connection

Plug a USB cable into the Touch USB port on the back of the monitor.

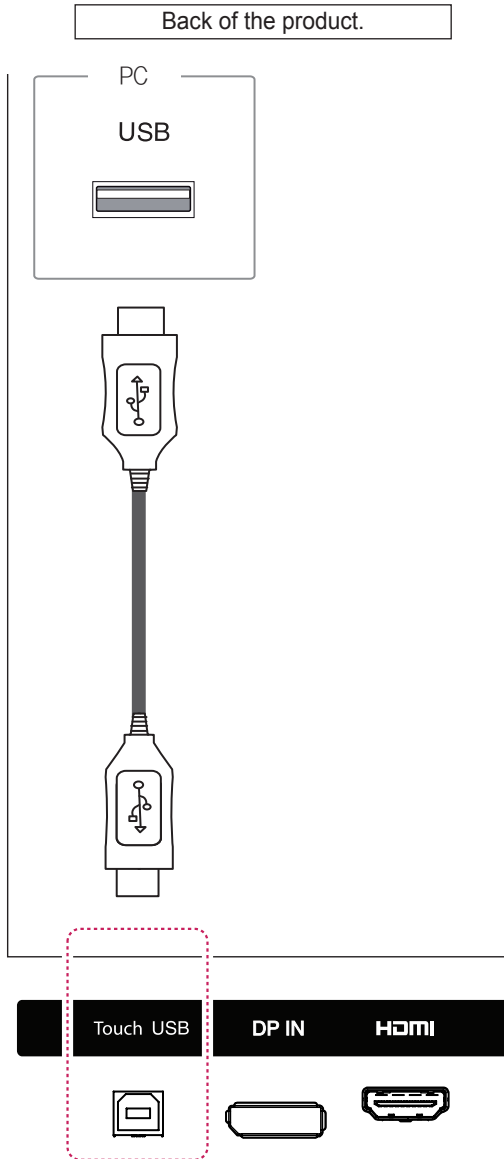

## Adjusting the Screen

### Selecting an Image Mode

Display images in its optimized settings by selecting one of the preset image modes.

- 1 Press **SETTINGS** to access the main menus.
- 2 Press the navigation buttons to scroll to **PICTURE** and press **OK**.
- 3 Press the navigation buttons to scroll to **Picture Mode** and press **OK**.
- 4 Press the navigation buttons to scroll to an image mode you want and press **OK**.

Mode	Description
<b>Vivid</b>	Adjusts the video image for the retail environment by enhancing the contrast, brightness, color, and sharpness.
<b>Standard</b>	Adjusts the image for the normal environment.
<b>Cinema</b>	Optimizes the video image for a cinematic look to enjoy movies as if you are in a movie theater.
<b>Sport</b>	Optimizes the video image for high and dynamic actions by emphasizing primary Colors such as white, grass, or sky blue.
<b>Game</b>	Optimizes the video image for a fast gaming screen such as PCs or games.

- 5 When you are finished, press **EXIT**.  
When you return to the previous menu, press **BACK**.

### Customizing Image Options

Customize basic and advanced options of each image mode for the best screen performance.

- 1 Press **SETTINGS** to access the main menus.
- 2 Press the navigation buttons to scroll to **PICTURE** and press **OK**.
- 3 Press the navigation buttons to scroll to **Picture Mode** and press **OK**.
- 4 Press the navigation buttons to scroll to an image mode you want and press **OK**.
- 5 Select and adjust following options, and then press **OK**.

Option	Description
<b>Backlight</b>	Adjusts the brightness of the screen by controlling the LCD backlight. If you decrease the brightness level, the screen becomes darker and the power consumption will be reduced without any video signal loss.
<b>Contrast</b>	Increases or decreases the gradient of the video signal. You may use contrast when the bright part of the picture is saturated.
<b>Brightness</b>	Adjusts the base level of the signal in the picture. You may use Brightness when the dark part of the picture is saturated.
<b>Sharpness</b>	Adjusts the level of crispness in the edges between the light and dark areas of the picture. The lower the level, the softer the image.
<b>Color</b>	Adjusts intensity of all colors.
<b>Tint</b>	Adjusts the balance between red and green levels.
<b>Color Temp.</b>	Set to warm to enhance hotter colors such as red, or set to cool to make picture bluish.
<b>Advanced Control</b>	Customizes the advanced options. Refer to the advanced image options.
<b>Picture Reset</b>	Restores the options to the default setting.

- 6 When you are finished, press **EXIT**.  
When you return to the previous menu, press **BACK**.

## Customizing PC Display Options

Customize options of each image mode for the best image quality.

- This function works in the following mode:  
RGB [PC] mode.
- 1 Press **SETTINGS** to access the main menus.
  - 2 Press the navigation buttons to scroll to **PICTURE** and press **OK**.
  - 3 Press the navigation buttons to scroll to **Screen** and press **OK**.
  - 4 Select and adjust following options, and then press **OK**.

Option	Description
<b>Resolution</b>	Selects a proper resolution.
<b>Auto Config.</b>	Sets to adjust the screen position, clock, and phase automatically. The displayed image may be unstable for a few seconds while the configuration is in progress.
<b>Position/ Size/Phase</b>	Adjusts the options when the picture is not clear, especially when characters are shaky, after the auto configuration.
<b>Reset</b>	Restores the options to the default setting.

- 5 When you are finished, press **EXIT**.  
When you return to the previous menu, press **BACK**.

## Adjusting the Sound

### Selecting an Sound Mode

Play the sound in its optimized settings by selecting one of the preset sound modes.

- 1 Press **SETTINGS** to access the main menus.
- 2 Press the navigation buttons to scroll to **AUDIO** and press **OK**.
- 3 Press the navigation buttons to scroll to **Sound Mode** and press **OK**.
- 4 Press the navigation buttons to scroll to a sound mode you want and press **OK**.

Mode	Description
<b>Standard</b>	Select when you want standard-quality sound.
<b>Music</b>	Select when you listen to music.
<b>Cinema</b>	Select when you watch movies.
<b>Sports</b>	Select when you watch sports events.
<b>Game</b>	Select when you watch sports events.

- 5 When you are finished, press **EXIT**.  
When you return to the previous menu, press **BACK**.

## Customizing Sound Options

Customize options of each sound mode for the best sound quality.

- 1 Press **SETTINGS** to access the main menus.
- 2 Press the navigation buttons to scroll to **AUDIO** and press **OK**.
- 3 Press the navigation buttons to scroll to **Sound Mode** and press **OK**.
- 4 Press the navigation buttons to scroll to a sound mode you want and press **OK**.
- 5 Select and adjust following options, and then press **OK**.

Option	Description
<b>Infinite Sound</b>	LG's Infinity Sound option provides 5.1 channel stereo sound from two speakers.
<b>Treble</b>	Controls the dominant sounds in the output. When you turn up the treble, it will increase the output to the lower frequency range.
<b>Bass</b>	Makes the output sound softer. If the bass is increased, the frequency of the output also increases.
<b>Reset</b>	Resets the sound mode to the default setting.

- 6 When you are finished, press **EXIT**.  
When you return to the previous menu, press **BACK**.

## Using Additional Options

### Using the Input List

- 1 Press **INPUT** to access the **Input List**.
- 2 Press the navigation buttons to scroll to one of the input mode and press **OK**.

Input mode	Description
<b>AV</b>	Watch video from a VCR or other external devices.
<b>Component</b>	Watch the contents in a DVD or other external devices, or through a digital set-top box
<b>RGB</b>	View a PC display on the screen
<b>HDMI</b>	Watch contents in a PC, DVD of digital set-top box other high definition devices
<b>DVI-D</b>	Watch contents in a PC, DVD of digital set-top box other high definition devices
<b>Display Port</b>	Watch contents in a PC, DVD of digital set-top box other high definition devices
<b>USB</b>	Plays the multimedia file saved in the USB.

## Adjusting Aspect Ratio

Resize the image to view the image at its optimal size by pressing **ARC** while you are watching monitor set.



### CAUTION

- If a fixed image displays on the screen for a long period of time, it will be imprinted and become a permanent disfigurement on the screen. This is image burn or burn-in and not covered by the warranty.
- To prevent image sticking, do not play a still image for more than two hours.
- If the aspect ratio is set to 4:3 for a long period of time, image burn may occur on the letterboxed area of the screen.
- Recommended operation time for optimum performance and reliability is 12 hours or less per day.
- When using the touch screen monitor, it is recommended to set the screen aspect ratio to **Just Scan**.



### NOTE

- You can also change the image size by accessing the main menus.
- The **Just Scan** mode operates when a video signal has resolution of 720p or higher.

Aspect Ratio	MODE	AV	Component	RGB	DVI		HDMI		Display Port	
				PC	DTV	PC	DTV	PC	DTV	PC
16:9		o	o	o	o	o	o	o	o	o
Just Scan		x	o	x	o	x	o	x	o	x
1:1		x	x	o	x	o	x	o	x	o
4:3		o	o	o	o	o	o	o	o	o
Zoom		o	o	x	o	x	o	x	o	x
Cinema Zoom		o	o	x	o	x	o	x	o	x

- **16:9** : This selection will allow you to adjust the picture horizontally, in linear proportion, to fill the entire screen (useful for viewing 4:3 formatted DVDs).

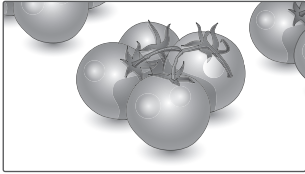

- **4:3** : This selection will allow you to view a picture with an original 4:3 aspect ratio, black bars will appear on both the left and right of the screen.

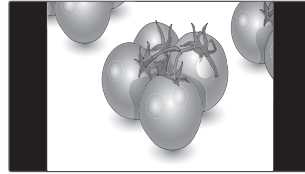

- **Just Scan** : This Selection will allow you view the picture of best quality without loss of original picture in high resolution image. Note: If there is noise in original Picture, You can see the noise at the edge.



- **Zoom** : This selection will allow you to view the picture without any alteration, while filling the entire screen. However, the top and bottom of the picture will be cropped.

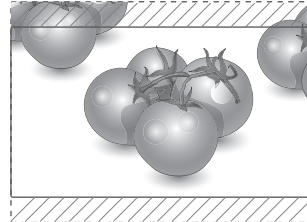

- **1:1** : The aspect ratio is not adjusted from the original. (Only Display Port PC, HDMI PC, DVI PC, RGB PC)

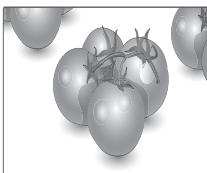

- **Cinema Zoom** : Choose Cinema Zoom when you want to enlarge the picture in correct proportion. Note: When enlarging or reducing the picture, the image may become distorted.

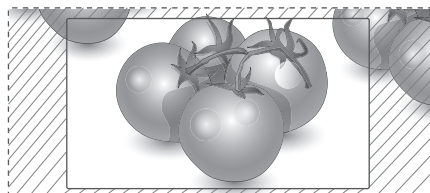

# ENTERTAINMENT

## Using the Network

### Connecting to a Wired Network

Connect the display to a local area network (LAN) via the LAN port as shown in the following illustration and set up the network settings.

Only supports wired network connection.

After making a physical connection, a small number of home networks may require the display network settings to be adjusted. For most home networks, the display will connect to automatically without any adjustments.

For detail information, contact your internet provider or router manual.

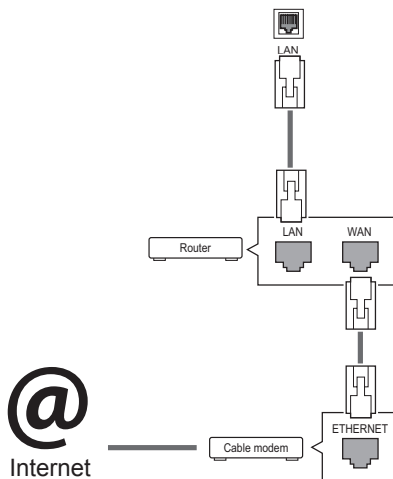

To set up the network settings: (Even if your display has already connected automatically, running setup again will not harm anything),

- 1 Press **SETTINGS** to access the main menus.
- 2 Press the navigation buttons to scroll to **NETWORK** and press **OK**.
- 3 Press the navigation buttons to select **Network Setting** and press **OK**.
- 4 If you already set network setting, select **Resetting**. The new connection settings resets the current network settings.
- 5 Select **IP Auto Setting** or **IP Manual Setting**.
  - If selecting **IP Manual Setting**, press the navigation and Number buttons. IP addresses will need to be input manually.
  - **IP Auto Setting**: Select this if there is a DHCP server (Router) on the local area network (LAN) via wired connection, the display will automatically be allocated an IP address. If you're using a broadband router or broadband modem that has a DHCP (Dynamic Host Configuration Protocol) server function. The IP address will automatically be determined.
- 6 When you are finished, press **EXIT**.

#### ! CAUTION

- Do not connect a modular phone cable to the LAN port.
- Since there are various connection methods, please follow the specifications of your telecommunication carrier or internet service provider.

#### ! CAUTION

- Network setting menu will not be available until the display connected to physical network.
- Since there are various connection methods, please follow the specifications of your telecommunication carrier or internet service provider.



### ! NOTE

- If you want to access the Internet directly on your display, the Internet connection should be always on.
- If you cannot access the Internet, check the network conditions from a PC on your network.
- When you use **Network Setting**, check the LAN cable or check if DHCP in the router is turned on.
- If you do not complete the network settings, the network may not work properly.

### Tips for Network setting

- Use a standard LAN cable with this display. Cat5 or better with a RJ45 connector.
- Many network connection problems during set up can often be fixed by re-setting the router or modem. After connecting the display to the home network, quickly power off and/or disconnect the power cable of the home network router or cable modem. Then power on and/or connect the power cable again.
- Depending on the internet service provider (ISP), the number of devices that can receive internet service may be limited by the applicable terms of service. For details, contact your ISP.
- LG is not responsible for any malfunction of the display and/or the internet connection feature due to communication errors/malfunctions associated with your internet connection, or other connected equipment.
- LG is not responsible for problems within your internet connection.
- You may experience undesired results if the network connection speed does not meet the requirements of the content being accessed.
- Some Internet connection operations may not be possible due to certain restrictions set by the Internet service provider (ISP) supplying your Internet connection.
- Any fees charged by an ISP including, without limitation, connection charges are your responsibility.
- A 10 Base-T or 100 Base-TX LAN port is required when using a wired connection to this display. If your Internet service does not allow for such a connection, you will not be able to connect the display.

- A DSL modem is required to use DSL service and a cable modem is required to use cable modem service. Depending on the access method of and subscriber agreement with your ISP, you may not be able to use the internet connection feature contained in this display or you may be limited to the number of devices you can connect at the same time. (If your ISP limits subscription to one device, this display may not be allowed to connect when a PC is already connected.)
- The use of a router may not be allowed or its usage may be limited depending on the policies and restrictions of your ISP. For details, contact your ISP directly.

## Network Status

- 1 Press **SETTINGS** to access the main menus.
- 2 Press the navigation buttons to scroll to **NETWORK** and press **OK**.
- 3 Press the navigation buttons to select **Network Status**.
- 4 Press **OK** to check the network status.
- 5 When you are finished, press **EXIT**.

Option	Description
<b>Setting</b>	Return to the network setting menu.
<b>Test</b>	Test the current network status after setting the network.
<b>Close</b>	Return to the previous menu.

## Using the My Media

### Connecting USB Storage Device

Connect an external hard drive to the monitor to use multimedia features.

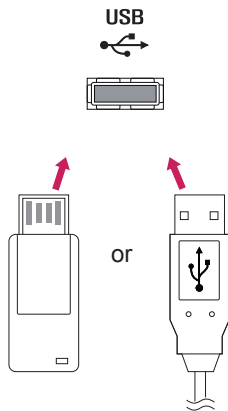

#### Tips for using USB storage devices

- Only a USB storage device is recognizable.
- If the USB storage device is connected through a USB hub, the device is not recognizable.
- A USB storage device using an automatic recognition program may not be recognized.
- A USB storage device which uses its own driver will not be recognized.
- The recognition speed of a USB storage device may depend on each device.
- Please do not turn off the display or unplug the USB device when the connected USB storage device is working. When such a device is suddenly separated or unplugged, the stored files or the USB storage device may be damaged.
- Please do not connect the USB storage device which was artificially maneuvered on the PC. The device may cause the product to malfunction. Only use a USB storage device which has normal music files, image files or movie files.
- Please use only a USB storage device which was formatted as a FAT32 file system or NTFS file system by with the Windows operating system. In case of a storage device formatted with a different utility programme which is not supported by Windows, it may not be recognized.
- Please connect power to a USB storage device (over 0.5 A) which requires an external power supply. If not, the device may not be recognized.
- Please connect a USB storage device with the cable included by the device maker.
- Some USB storage devices may not be supported or operate smoothly.
- File alignment method of USB storage devices is similar to Window XP and the monitor can recognize up to 100 English characters.
- Be sure to back up important files since data stored on a USB memory device may be damaged. We will not be responsible for any data loss.

- If the USB HDD does not have an external power source, the USB device may not be detected. So be sure to connect the external power source.
  - Please use a power adaptor for an external power source.
- If your USB memory device has multiple partitions, or if you use a USB multi-card reader, you can use up to 4 partitions or USB memory devices.
- If a USB memory device is connected to a USB multi-card reader, its volume data may not be detected.
- If the USB memory device does not work properly, disconnect and reconnect it.
- How fast a USB memory device is detected differs from device to device.
- If the USB is connected in Standby Mode, that drive will automatically be loaded when the display is turned on.
- The recommended capacity is 1 TB or less for a USB external hard disk and 32 GB or less for USB memory.
- Any device with more than the recommended capacity may not work properly.
- If a USB external hard disk with a Energy Saving function does not work, turn the hard disk off and on again to make it work properly.
- USB storage devices below USB 2.0 are supported as well. But they may not work properly with videos.
- A maximum of 999 folders or files can be recognized under one folder.
- It is recommended you use a certified USB storage device and cable. Otherwise, a USB storage device may not be detected or a playback error may occur.
- Only a USB memory device can be used to play back the files distributed and stored by SuperSign Manager. A USB hard disk or multi-card reader will not work.
- Only an FAT 32 file formatted storage device can play back the files distributed and stored by SuperSign manager.
- A USB 3.0 storage device may not work.

## Browsing Files

Browse for a file saved on a USB storage.

- 1 Press **SETTINGS** to access the main menu.
- 2 Press the search button to scroll to **MY MEDIA** and press **OK**.
- 3 Press the Search button to go to the **Movie List, Photo List, Music List, or Content List** that you want, and press **OK**.

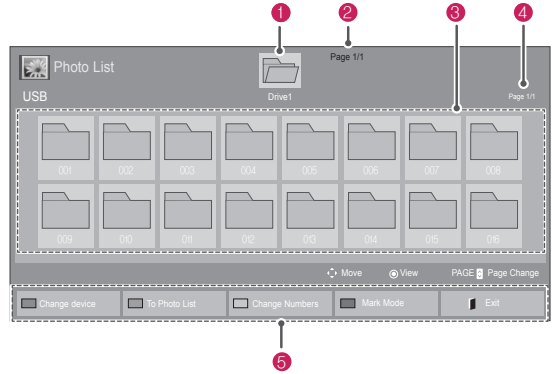
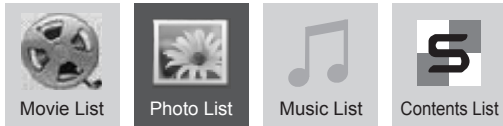

No.	Description
①	Upper level folder
②	Current page/Total pages
③	Contents under the folder focused on ①
④	Current page/Total pages of contents under the folder focused on ①
⑤	Remote button
Remote button	Description
Green button	Press the green button to toggle between <b>Photo List -&gt; Music List, Music List -&gt; Contents List, Contents List -&gt; Movie List or Movie List -&gt; Photo List.</b>
Yellow button	A method to view in 5 large thumbnail or simple list.
Blue button	Convert to Mark Mode.

**Supported file format**

Type	Supported file format									
<b>Movie</b>	<p><b>DAT,MPG,MPEG,VOB,AVI,DivX,MP4,MKV,TS,TRP,TP,ASF,WMV,FLV)</b></p> <p><b>Movie</b>(* .mpg/* .mpeg/* .dat/* .ts/* .trp/* .tp/* .vob/* .mp4/* .mov/* .mkv/* .divx/* .avi/* .asf/* .wmv/* .flv/* .avi(motion-jpeg)/* .mp4(motion-jpeg)/* .mkv(motion-jpeg))supporting file</p> <p><b>Video format</b> : DivX3.11, DivX4, DivX5.x, DivX6, Xvid1.00, Xvid1.01, Xvid1.02, Xvid1.03, Xvid1.10 beta-1/beta-2,</p> <p>Mpeg-1, Mpeg-2, Mpeg-4, H.264/AVC, VC1, JPEG, Sorenson H.263</p> <p><b>Audio format</b> : Dolby Digital, AAC, Mpeg, MP3, LPCM, HE-AAC, ADPCM, WMA</p> <p><b>Bit rate</b> : within 32 kbps to 320 kbps(MP3)</p> <p><b>External Subtitle format</b> : *.smi/* .srt/* .sub (MicroDVD,Subviewer1.0/2.0)/* .ass/* .ssa/* .txt(TMPlayer)/* .psb(PowerDivX)</p> <p><b>Internal Subtitle format</b> : only, XSUB (It is the subtitle format used in DivX6 files)</p>									
<b>Photo</b>	<p>JPEG</p> <p>Baseline : 64 x 64 to 15360 x 8640 Progressive : 64 x 64 to 1920 x 1440</p> <ul style="list-style-type: none"> <li>You can play JPEG files only.</li> <li>Non-supported files are displayed in the form of predefined icon.</li> </ul> <table border="1"> <thead> <tr> <th>File Extensions</th> <th>Item</th> <th>Profile</th> </tr> </thead> <tbody> <tr> <td>jpeg jpg jpe</td> <td>supported file format</td> <td> <ul style="list-style-type: none"> <li>SOF0: baseline</li> <li>SOF1: Extend Sequential</li> <li>SOF2: Progressive</li> </ul> </td> </tr> <tr> <td></td> <td>photo size</td> <td> <ul style="list-style-type: none"> <li>Min: 64 x 64</li> <li>Max-Normal Type:</li> <li>15360 (W) x 8640 (H)</li> <li>Progressive Type:</li> <li>1920 (W) x 1440 (H)</li> </ul> </td> </tr> </tbody> </table>	File Extensions	Item	Profile	jpeg jpg jpe	supported file format	<ul style="list-style-type: none"> <li>SOF0: baseline</li> <li>SOF1: Extend Sequential</li> <li>SOF2: Progressive</li> </ul>		photo size	<ul style="list-style-type: none"> <li>Min: 64 x 64</li> <li>Max-Normal Type:</li> <li>15360 (W) x 8640 (H)</li> <li>Progressive Type:</li> <li>1920 (W) x 1440 (H)</li> </ul>
File Extensions	Item	Profile								
jpeg jpg jpe	supported file format	<ul style="list-style-type: none"> <li>SOF0: baseline</li> <li>SOF1: Extend Sequential</li> <li>SOF2: Progressive</li> </ul>								
	photo size	<ul style="list-style-type: none"> <li>Min: 64 x 64</li> <li>Max-Normal Type:</li> <li>15360 (W) x 8640 (H)</li> <li>Progressive Type:</li> <li>1920 (W) x 1440 (H)</li> </ul>								
<b>Music</b>	<p>MP3</p> <p>Bit rate 32 to 320</p> <ul style="list-style-type: none"> <li>Sampling rate MPEG1 Layer3 : 32 kHz, 44.1 kHz, 48 kHz</li> <li>Sampling rate MPEG2 Layer3 : 16 kHz, 22.05 kHz, 24 kHz</li> <li>Sampling rate MPEG2.5 Layer3 : 8 kHz, 11.025 kHz, 12 kHz</li> </ul>									

Type	Supported file format																
<b>Content</b> (when using SuperSign Manager)	<p>File Extensions : *.cts/ *.cse</p> <p>Movie</p> <p><b>File Extensions:</b> *.mpg/* .mpeg/* .dat/* .ts/* .trp/* .tp/* .vob/* .mp4/* .mov/* .mkv/* .avi/* .asf/* .wmv/* .avi(motion JPEG)/* .mp4(motion JPEG)/* .mkv(motion JPEG)</p> <p><b>Video format:</b> MPEG1, MPEG2, MPEG4,H.264/AVC, DivX 3.11, DivX 4.12, DivX 5.x, DivX 6, Xvid 1.00,Xvid 1.01, Xvid 1.02, Xvid 1.03,Xvid 1.10-beta1/2, JPEG, VC1(WVC1/WMV3)</p> <p><b>Audio format:</b> MP2,MP3,Dolby Digital, LPCM, AAC, HE-AAC,LPCM, ADPCM, WMA, MP3</p> <table border="1"> <thead> <tr> <th></th> <th>File Extensions</th> <th>Item</th> <th>Profile</th> </tr> </thead> <tbody> <tr> <td rowspan="2">Photo</td> <td rowspan="2">JPEG JPG PNG BMP</td> <td>supported file format</td> <td> <ul style="list-style-type: none"> <li>SOF0: baseline</li> <li>SOF1: Extend Sequential</li> <li>SOF2: Progressive</li> </ul> </td> </tr> <tr> <td>Photo size</td> <td> <ul style="list-style-type: none"> <li>Min: 64 x 64</li> <li>Max Type: 1366 x 768</li> </ul> </td> </tr> <tr> <td rowspan="2">Music</td> <td rowspan="2">MP3</td> <td>Bit rate</td> <td>32 kbps to 320 kbps</td> </tr> <tr> <td>Sampling rate</td> <td>32 kHz, 44.1 kHz, 48 kHz (MPEG1 L3) 16 kHz, 22.05 kHz, 24 kHz (MPEG2 L3) 8kHz, 11.025 kHz, 12 kHz (MPEG2.5 L3)</td> </tr> </tbody> </table>		File Extensions	Item	Profile	Photo	JPEG JPG PNG BMP	supported file format	<ul style="list-style-type: none"> <li>SOF0: baseline</li> <li>SOF1: Extend Sequential</li> <li>SOF2: Progressive</li> </ul>	Photo size	<ul style="list-style-type: none"> <li>Min: 64 x 64</li> <li>Max Type: 1366 x 768</li> </ul>	Music	MP3	Bit rate	32 kbps to 320 kbps	Sampling rate	32 kHz, 44.1 kHz, 48 kHz (MPEG1 L3) 16 kHz, 22.05 kHz, 24 kHz (MPEG2 L3) 8kHz, 11.025 kHz, 12 kHz (MPEG2.5 L3)
	File Extensions	Item	Profile														
Photo	JPEG JPG PNG BMP	supported file format	<ul style="list-style-type: none"> <li>SOF0: baseline</li> <li>SOF1: Extend Sequential</li> <li>SOF2: Progressive</li> </ul>														
		Photo size	<ul style="list-style-type: none"> <li>Min: 64 x 64</li> <li>Max Type: 1366 x 768</li> </ul>														
Music	MP3	Bit rate	32 kbps to 320 kbps														
		Sampling rate	32 kHz, 44.1 kHz, 48 kHz (MPEG1 L3) 16 kHz, 22.05 kHz, 24 kHz (MPEG2 L3) 8kHz, 11.025 kHz, 12 kHz (MPEG2.5 L3)														

## Viewing movies

Play video files on display. Your display shows all of the video files saved in a USB storage device or shared folder on a PC.

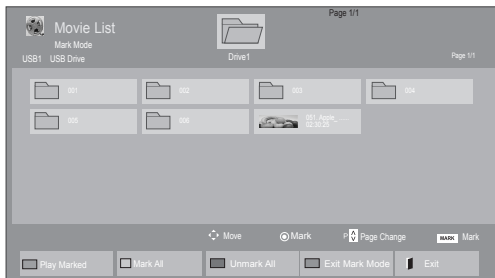
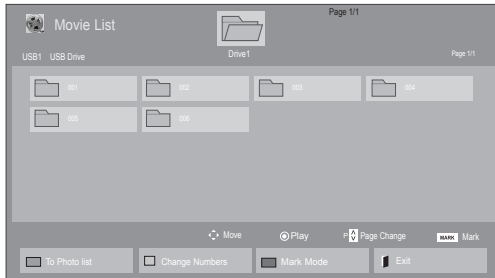

- 1 Press the Navigation buttons to scroll to **My Media** and press **OK**.
- 2 Press the Navigation buttons to scroll to **Movie List** and press **OK**.
- 3 Press the Navigation buttons to scroll to a folder you want and press **OK**.
- 4 Press the Navigation buttons to scroll to a file you want and press **OK**.



Menu	Description
<b>Play Marked</b>	Play the selected movie file. Once a movie file finishes playing, the next selected one will be played automatically.
<b>Mark All</b>	Mark all movie files on the screen.
<b>Unmark All</b>	Deselect all marked movie files.
<b>Exit Mark Mode</b>	Exit the Mark Mode.

- 5 Play a movie.

### NOTE

- Non-supported files are displayed the preview image by icon only .
- Abnormal files are displayed in the form of bitmap .

6 When plays a video, you can set the following:



Remote button	Description
	Stops the playback
	Plays a video
	Pauses or resumes the playback
	Scans backward in a file
	Scans forward in a file
<b>ENERGY SAVING</b> 	Adjusts the screen brightness to save energy.
<b>SETTINGS</b>	Show the Option menu.
 <b>BACK</b>	Hide the menu on the full-sized screen.
<b>EXIT</b>	Return to <b>Movie List</b> .
	Skips to specific points in a file during playback. The time of a specific point will appear on the status bar. In some files, this function may not work properly.

### NOTE

- Any unsupported file formats will be marked with an icon in the lower right corner of their thumbnails.
- Any unsupported file formats will be marked with an icon in the lower right corner of their thumbnails..

### Tips for using playing video files

- Some user-created subtitles may not work properly.
- Some special characters are not supported in subtitles.
- HTML tags are not supported in subtitles.
- Subtitles in languages other than the supported languages are not available.
- The screen may suffer temporary interruptions (image stoppage, faster playback, etc.) when the audio language is changed.
- A damaged movie file may not be played correctly, or some player functions may not be usable.
- Movie files produced with some encoders may not be played correctly.
- If the video and audio structure of recorded file is not interleaved, either video or audio is outputted.
- HD videos with a maximum of 1920x1080@25/30P or 1280x720@50/60P are supported, depending on the frame.
- Videos with resolutions higher than 1920x1080@25/30P or 1280x720@50/60P may not work properly depending on the frame.
- Movie files other than the specified types and formats may not work properly.
- Max bitrate of playable movie file is 20 Mbps. (only, Motion JPEG : 10 Mbps)
- We do not guarantee smooth playback of profiles encoded level 4.1 or higher in H.264/AVC.
- DTS Audio codec is not supported.
- A movie file more than 30 GB in file size is not supported for playback.
- A DivX movie file and its subtitle file must be located in the same folder.
- A video file name and its subtitle file name must be identical for it to be displayed.
- Playing a video via a USB connection that doesn't support high speed may not work properly.
- Files encoded with GMC (Global Motion Compensation) may not be played.

**Video options**

- 1 Press **SETTINGS** to access the Pop-Up menus.
- 2 Press the navigation buttons to scroll to **Set Video Play**, **Set Video** or **Set Audio** and press **OK**.

**! NOTE**

- The option values changed in **Movie List** do not affect **Photo List** or **Music List**. Therefore, they are not affected by option values changed in **Photo List** or **Music List**.
- The option values changed in **Photo List** and **Music List** do affect each other.
- When replaying the video file after stopping, you can play from where it stopped previously.

Select **Set Video Play** to access the following menus:

Menu	Description
<b>Picture Size</b>	Selects your desired picture format during movie play.
<b>Audio Language</b>	Changes the Language Group of the audio during movie play. Files with a single audio track cannot be selected.
<b>Subtitle Language</b>	Turn on/off the subtitle.
<b>Language</b>	Activated for SMI subtitle and can select the language within the subtitle.
<b>Code Page</b>	Can select the font for subtitle. When set to default, same font as general menu will be used.
<b>Sync</b>	Adjusts the time synchronisation of the subtitle from -10 secs to +10 secs by steps of 0.5 secs during movie play.
<b>Position</b>	Changes the position of the subtitle either up or down during movie play.

Menu	Description
<b>Size</b>	Selects your desired Subtitle size during movie play.
<b>Repeat</b>	Turn on/off repeat function of movie playback. When turned on, the file within the folder will be played back repeatedly. Even when the repeated playback is turned off, it can run the playback if the file name is similar to the previous file.

**! NOTE**

- Only 10,000 of sync blocks can be supported within the subtitle file.
- When playing a video, you can adjust the picture size by pressing the **ARC** button.
- Subtitles in your language are only supported when the OSD menu is also in this language.
- The code page options may be disabled depending on the language of the subtitle files.
- Select the appropriate code page for the subtitle files.

For more details about the **Set Video** menu, see the **CUSTOMIZE SETTINGS** section. See page 42.

For more details about the **Set Audio** menu, see the **CUSTOMIZE SETTINGS** section. See page 45.



## Viewing photos

View image files saved in a USB storage device. The displays on the screen may differ from the model.

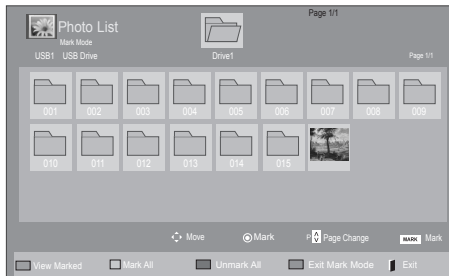
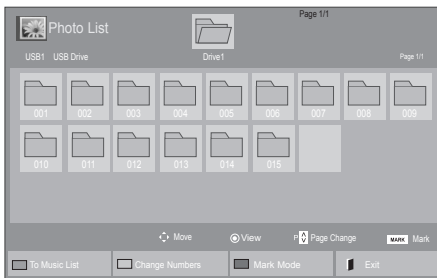

- 1 Press the Navigation buttons to scroll to **My Media** and press **OK**.
- 2 Press the Navigation buttons to scroll to **Photo List** and press **OK**.
- 3 Press the Navigation buttons to scroll to a folder you want and press **OK**.
- 4 Press the Navigation buttons to scroll to a file you want and press **OK**.



Menu	Description
<b>View Marked</b>	Display the selected photo file.
<b>Mark All</b>	Mark all photo files on the screen.
<b>Unmark All</b>	Deselect all marked photo files.
<b>Exit Mark Mode</b>	Exit the Mark Mode.

- 5 View photos.

### NOTE

- Non-supported files are displayed the pre-view image by icon only .
- Abnormal files are displayed in the form of bitmap .

6 When playing a video, you can set the following:



Options

Number of selected photos

Menu	Description
<b>Slideshow</b>	Starts or stops a slideshow with selected photos. If there are no selected photos, all photos saved in the current folder display during a slideshow. To set a slideshow speed, select <b>Option</b> .
<b>BGM</b>	Turns the background music on or off. To set the background music folder, select <b>Option</b> . You can adjust option by <b>SETTINGS</b> button on the remote control.
	Rotates photos clockwise (90°, 180°, 270°, 360°).  <div style="border: 1px solid black; padding: 5px;"> <p><b>NOTE</b></p> <ul style="list-style-type: none"> <li>The supported photo size is limited. You cannot rotate a photo if the resolution of the rotated width is larger than the supported resolution size.</li> </ul> </div>
	View the photo by zoom in 2 or 4 times.  <div style="border: 1px solid black; padding: 5px;"> <p><b>NOTE</b></p> <ul style="list-style-type: none"> <li>Photos with a resolution of 960x540 or less cannot be enlarged.</li> </ul> </div>
	Adjusts the screen brightness to save energy.

Menu	Description
<b>Option</b>	<ul style="list-style-type: none"> <li><b>Slide Speed:</b> Selects a slideshow speed (<b>Fast</b>, <b>Medium</b>, <b>Slow</b>).</li> <li><b>TransitionEffect:</b> Set the view mode of the slideshow.</li> <li><b>BGM:</b> Selects a music folder for the background music.</li> </ul> <div style="border: 1px solid black; padding: 5px; margin-top: 10px;"> <p><b>NOTE</b></p> <ul style="list-style-type: none"> <li>You cannot change the music folder while the background music is playing.</li> <li>You can only select the MP3 folder saved on the device that currently displays the photo.</li> </ul> </div>
<b>Hide</b>	Hides the option window. To display the options, press <b>OK</b> .
<b>Exit</b>	Return to <b>Photo List</b> .

**Photo options**

- 1 Press **SETTINGS** to show the **Option** menus.
- 2 Press the navigation buttons to scroll to **Set Photo View**, **Set Video** or **Set Audio** and press **OK**.





**NOTE**

- The option values changed in **Movie List** do not affect **Photo List** or **Music List**. Therefore, they are not affected by option values changed in **Photo List** or **Music List**.
- The option values changed in **Photo List** and **Music List** do affect each other.

If you select **Set Photo View**, you can make adjustments as shown below:

- 1 Press the navigation buttons to scroll to select **Slide Speed**, **Transition Effect**, or **BGM**.
- 2 Press the navigation buttons to scroll to make appropriate adjustments.

### Transition Effect Option

Option	Description
<b>Sliding</b>	Pushes the current slide out of view as it plays to the next slide. 
<b>Stairs</b>	Pushes the current slide in a staircase shape as it plays to the next slide. 
<b>Door Open /Close</b>	Pushes the current slide like opening or closing the door as it plays to the next slide. 
<b>Shutter</b>	Pushes the current slide like drawing or pulling down the blind as it plays to the next slide. 
<b>Fade In</b>	The current photo disappears and the next photo appears slowly. 

For more details about the **Set Video** menu, see the **CUSTOMIZE SETTINGS** section. See page 42.

For more details about the **Set Audio** menu, see the **CUSTOMIZE SETTINGS** section. See page 45.

## Listening to music

- 1 Press the Navigation buttons to scroll to **My Media** and press **OK**.
- 2 Press the Navigation buttons to scroll to **Music List** and press **OK**.
- 3 Press the Navigation buttons to scroll to a folder you want and press **OK**.
- 4 Press the Navigation buttons to scroll to a file you want and press **OK**.

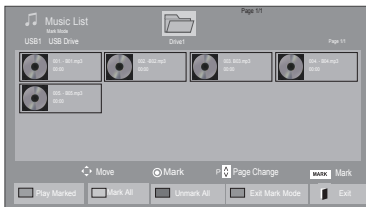
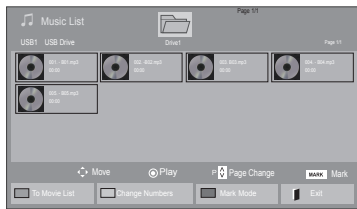

Menu	Description
<b>Play Marked</b>	Display the selected music file.
<b>Mark All</b>	Mark all music files on the screen.
<b>Unmark All</b>	Deselect all marked music files.
<b>Exit Mark Mode</b>	Exit the Mark Mode.

- 5 Play music.

- 6 When listening to music, you can set the following:

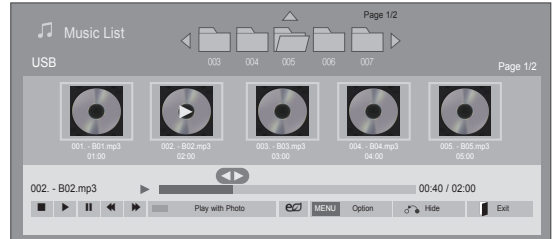











Remote button	Description
	Stops playing back the file and moves back to the <b>Music List</b> .
	Plays a music file.
	Pauses or resumes playback
	Skips to the next file
	Skips to the previous file
Green button	Start playing the selected music files and then move to the <b>Photo List</b> .
<b>ENERGY SAVING</b> 	Adjusts the screen brightness to save energy.
<b>SETTINGS</b>	Show the <b>Option</b> menu.
 <b>BACK</b>	Hides the option window. To display the options, press <b>OK</b> .
<b>EXIT</b>	Return to <b>Music List</b> .
	Skips to specific points in a file during playback. The time of a specific point will appear on the status bar. In some files, this function may not work properly.

**Tips for playing music files**

- This unit cannot support the ID3 Tag embedded MP3 files.

**! NOTE**

- Non-supported files are displayed the preview image by icon only .
- Abnormal files are displayed in the form of bitmap .
- A damaged or corrupted music file does not play but displays 00:00 in playtime.
- A music downloaded from a paid service with copyright protection does not start but displays inappropriate information in playtime.
- If you press OK,  buttons, screen saver is stopped.
- The PLAY , Pause , , ,  buttons on the remote control are also available in this mode.
- You can use the  button to select the next music and the  button to select the previous music.

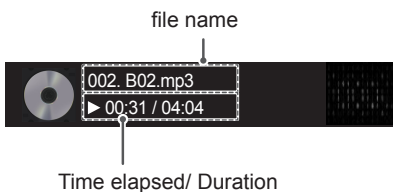
**Music options**

- 1 Press **SETTINGS** to access the pop-up menus.
- 2 Press the navigation buttons to scroll to **Set Audio Play** or **Set Audio** and press **OK**.

**! NOTE**

- The option values changed in **Movie List** do not affect **Photo List** or **Music List**. Therefore, they are not affected by option values changed in **Photo List** or **Music List**.
- The option values changed in **Photo List** and **Music List** do affect each other.

When you select the **Set Audio Play**,

- 1 Press the navigation buttons to scroll to select the **Repeat** or **Random**.
- 2 Press the navigation buttons to scroll to make appropriate adjustments.

For more details about the **Set Audio**. menu, see the **CUSTOMIZE SETTINGS** section. See page 45.

## Viewing the Contents List

Plays back the stored files using the Export option in SuperSign Manager.

- 1 Press the Navigation buttons to scroll to **My Media** and press **OK**.
- 2 Press the Navigation buttons to scroll to **Contents List** and press **OK**.
- 3 Press the Navigation buttons to scroll to a folder you want and press **OK**.
- 4 Press the Navigation buttons to scroll to a file you want and press **OK**.

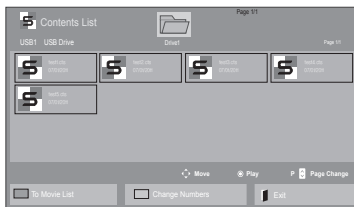

### NOTE

- While playing media files from Contents List, only the BACK, EXIT or Volume button are available. Selecting the BACK or EXIT button stops playing media files and returns to the screen view mode.
- If there is the AutoPlay folder in the USB device and its files are in supported formats, they can be played back automatically when the USB device is connected to the monitor.

## DivX® VOD Guide

### DivX® VOD Registration

In order to play purchased or rented DivX® VOD contents, you should register your device with 10 digit DivX registration code from your device at [www.divx.com/vod](http://www.divx.com/vod).

- 1 Press **SETTINGS** to access the main menus.
- 2 Press the navigation buttons to scroll to **MY MEDIA** and press **OK**.
- 3 Press the Blue button.
- 4 Press the navigation buttons to scroll to **DivX Reg. Code** and press **OK**.
- 5 View the registration code of your display.
- 6 When you are finished, press **EXIT**.  
When you return to the previous menu, press **BACK**.

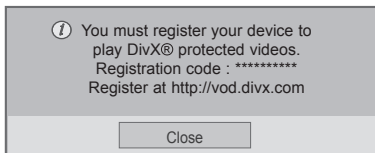

### NOTE

- While you are checking the registration code, some buttons may not work.
- If you use the DivX registration code of another device, you cannot play the rented or purchased DivX file. Make sure to use the DivX registration code assigned to your product.
- The video or audio files that are not converted by the standard DivX codec may be corrupted or not be played.
- The DivX VOD code allows you to activate up to 6 devices under one account.

### DivX® VOD Deregistration

You should deregister your device with 8 digit DivX deregistration code from your device at [www.divx.com/vod](http://www.divx.com/vod).

- 1 Press **SETTINGS** to access the main menus.
- 2 Press the navigation buttons to scroll to **MY MEDIA** and press **OK**.
- 3 Press the Blue button.
- 4 Press the navigation buttons to scroll to **Deactivation** and press **OK**.
- 5 Press the navigation buttons to select **Yes** to confirm.

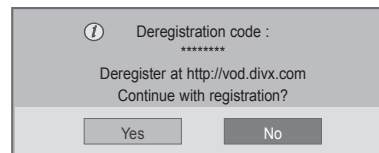

- 6 When you are finished, press **EXIT**.  
When you return to the previous menu, press **BACK**.

### NOTE

- Once the deregistration is executed, you must register your device again to see DivX® VOD contents.

## Using PIP/PBP

Displays videos and photos stored on the USB on a single monitor with the main and sub screens divided. (See page 50.)

- 1 Press **SETTINGS** to access the main menus.
- 2 Press the navigation buttons to scroll to **OPTION** and press **OK**.
- 3 Press **PIP/PBP** to select **PIP** or **PBP** and then press **OK**.

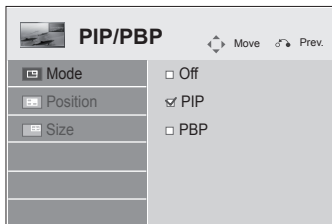

- 4 Select **Movie List** or **Photo List** from **My Media**. (With **PIP/PBP** selected, the **Music List** and **Contents List** are deactivated.)

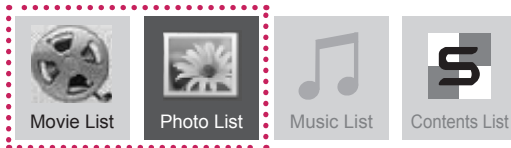

- 5 Select a file you want and then press **OK**.

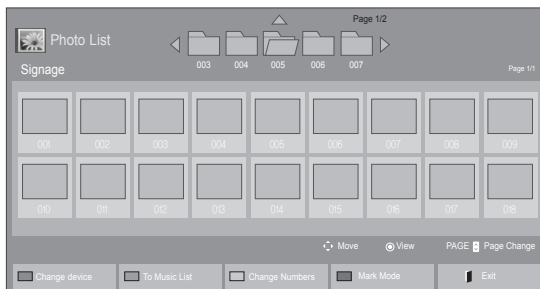

- 6 Select the PIP or PBP icon from the play list.



### Movie List



### Photo List

- 7 Select either Main or Sub for sound. You must to select the output sound before running the PIP or PBP function.

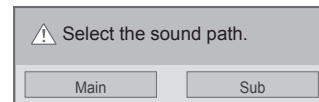

- 8 The sub screen is displayed on the main screen.





# CUSTOMIZING SETTINGS

## Accessing Main Menus

- 1 Press **SETTINGS** to access the main menus.
- 2 Press the navigation buttons to scroll to one of the following menus and press **OK**.
- 3 Press the navigation buttons to scroll to the setting or option you want and press **OK**.
- 4 When you are finished, press **EXIT**.  
When you return to the previous menu, press **BACK**.

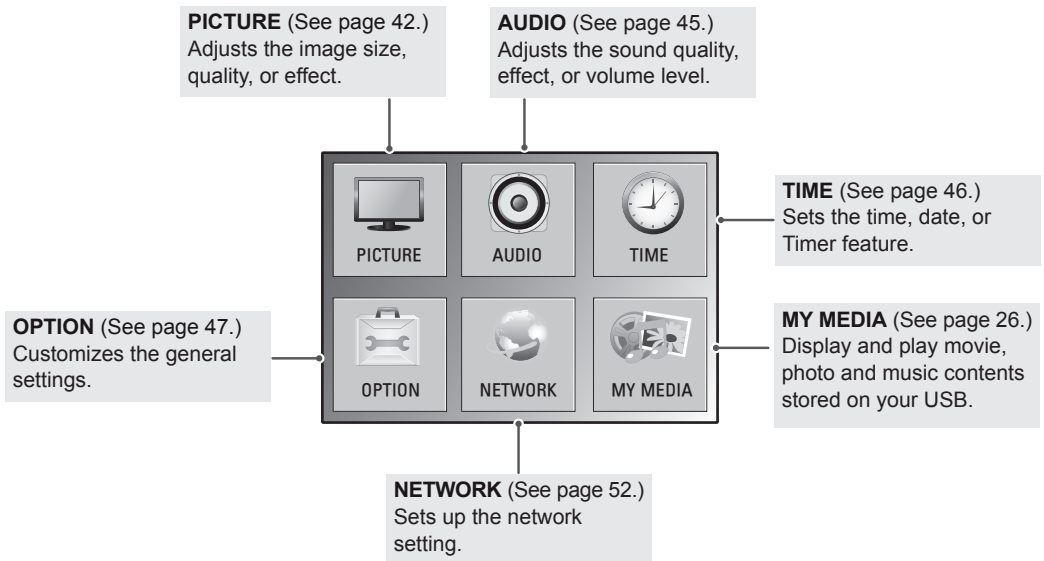
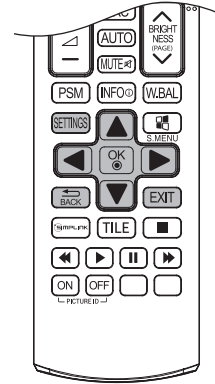

## PICTURE Settings

- 1 Press **SETTINGS** to access the main menus.
- 2 Press the navigation buttons to scroll to **PICTURE** and press **OK**.
- 3 Press the navigation buttons to scroll to the setting or option you want and press **OK**.  
- To return to the previous level, press **BACK**.
- 4 When you are finished, press **EXIT**.  
When you return to the previous menu, press **BACK**.

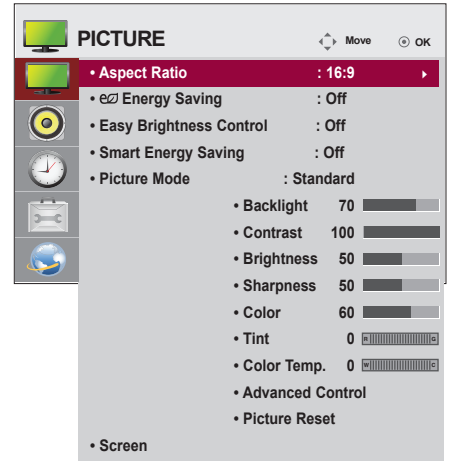

The available picture settings are described in the following:

Setting	Description	
<b>Aspect Ratio</b>	Changes the image size to view images at its optimal size. (See page 22.)	
<b>e Energy Saving</b>	Sets to automatically adjust the screen brightness corresponding to the surroundings.	
	<b>Level</b>	
	<b>Off</b>	Disables Energy Saving function.
	<b>Minimum/ Medium/ Maximum</b>	Selects the brightness level of the backlight.
	<b>Screen Off</b> The screen turns off in 3 seconds.	
<b>Easy Brightness Control</b>	Adjusts the backlight according to the schedule you set.	
	<b>Mode</b>	
	<b>Off</b>	Disables Easy Brightness Control.
	<b>On</b>	Enables Easy Brightness Control.
	<div style="border: 1px solid black; padding: 10px;"> <p><b>NOTE</b></p> <ul style="list-style-type: none"> <li>• Easy Brightness Control is disabled if the current time is not set.</li> <li>• If Energy Saving is set to Maximum, Easy Brightness Control is disabled.</li> <li>• You can set up to six schedules and they will be sorted in time ascending order.</li> <li>• If more than six schedules are added, the latest schedule will be automatically deleted.</li> <li>• You can delete a schedule by pressing the OK button.</li> <li>• Duplicate schedules are not added, but the backlight value changes.</li> <li>• It may not be supported depending on the model.</li> </ul> </div>	
<b>Smart Energy Saving</b>	Adjusts the backlight and contrast depending on the screen brightness.	
	<b>Level</b>	
	<b>Off</b>	Disables the Smart Energy Saving function.
	<b>On</b>	Enables the Smart Energy Saving function to save power consumption as much as the value set in the smart energy saving rate.

Setting	Description	
<b>Picture Mode</b>	Selects one of the preset image or customizes options in each mode for the best monitor set screen performance. You are also able to customize advanced options of each mode. The available preset picture modes vary depending on the monitor set .	
	<b>Mode</b>	
	Vivid	Adjusts the video image for the retail environment by enhancing the contrast, brightness, color, and sharpness.
	Standard	Adjusts the image for the normal environment.
	Cinema	Optimizes the video image for a cinematic look to enjoy movies as if you are in a movie theater.
	Sport	Optimizes the video image for high and dynamic actions by emphasizing primary Colors such as white, grass, or sky blue.
	Game	Optimizes the video image for a fast gaming screen such as PCs or games.
<b>SCREEN (In RGB Mode Only)</b>	Customizes the PC display options in RGB mode.	
	<b>Option</b>	
	Resolution	Selects a proper resolution.
	Auto Configure	Sets to adjust the screen position, clock, and phase automatically. The displayed image may be unstable for a few seconds while the configuration is in progress.
	Position/Size/ Phase	Adjusts the options when the picture is not clear, especially when characters are shaky, after the auto configuration.
	Reset	Restores the options to the default setting.

### Picture Mode options

Setting	Description
<b>Backlight</b>	Adjusts the brightness of the screen by controlling the LCD backlight. If you decrease the brightness level, the screen becomes darker and the power consumption will be reduced without any video signal loss.
<b>Contrast</b>	Increases or decreases the gradient of the video signal. You may use contrast when the bright part of the picture is saturated.
<b>Brightness</b>	Adjusts the base level of the signal in the picture. You may use brightness when the dark part of the picture is saturated.
<b>Sharpness</b>	Adjusts the level of crispness in the edges between the light and dark areas of the picture. The lower the level, the softer the image.
<b>Color</b>	Adjusts intensity of all colors.
<b>Tint</b>	Adjusts the balance between red and green levels.
<b>Color Temp .</b>	Set to warm to enhance hotter colors such as red, or set to cool to make picture bluish.
<b>Advanced Control</b>	Customizes the advanced options. Refer to the advanced image options. (See page 44.)
<b>Picture Reset</b>	Restores the options to the default setting.

## Advanced Control

Setting	Description
<b>Dynamic Contrast (Off/High/Medium/Low)</b>	Adjusts the contrast to keep it at the best level according to the brightness of the screen. The picture is improved by making bright parts brighter and dark parts darker. (Function works in the following mode - AV, Component, DP, HDMI, DVI)
<b>Dynamic Color (Off/High/Low)</b>	Adjusts screen Colors so that they look livelier, richer, and clearer. This feature enhances hue, saturation and luminance so that red, blue, green and white look more vivid. (Function works in the following mode - AV, Component, DP, HDMI, DVI)
<b>Clear White (Off/High/Low)</b>	Make the white area of screen brighter and more white.
<b>Skin Color (-5 to 5)</b>	It detects the skin area of video and adjusts it to express a natural skin color.
<b>Noise Reduction (Off/High/Medium/Low)</b>	Reduces screen noise without compromising video quality. (Function works in the following mode - Component, DP, HDMI, DVI)
<b>Digital Noise Reduction (Off/High/Medium/Low)</b>	This option reduces the noise produced while creating digital video signals.
<b>Gamma (High/Medium/Low)</b>	Set your own gamma value. On the monitor, high gamma values display whitish images and low gamma values display high contrast images.
<b>Black Level (High/Low)</b>	<ul style="list-style-type: none"> <li>● Low: The picture of the screen gets darker.</li> <li>● High: The picture of the screen gets brighter.</li> </ul> Set black level of the screen to proper level. (Function works in the following mode - AV, Component, DP, HDMI, DVI)

**NOTE**

- If the **Picture Mode** setting in the Picture menu is set to **Vivid, Standard, Cinema, Sport, or Game**, the subsequent menus will be automatically set.
- You cannot adjust **Sharpness, Color and Tint** in the RGB/ DP/ HDMI-PC/ DVI-PC mode.
- When using the Smart Energy Saving function, the screen may look saturated in the white area of a still image.
- If Energy Saving is set to Minimum, Medium, or Maximum, the Smart Energy Saving function is disabled.

## AUDIO Settings

- 1 Press **SETTINGS** to access the main menus.
- 2 Press the navigation buttons to scroll to **AUDIO** and press **OK**.
- 3 Press the navigation buttons to scroll to the setting or option you want and press **OK**.  
- To return to the previous level, press **BACK**.
- 4 When you are finished, press **EXIT**.  
When you return to the previous menu, press **BACK**.

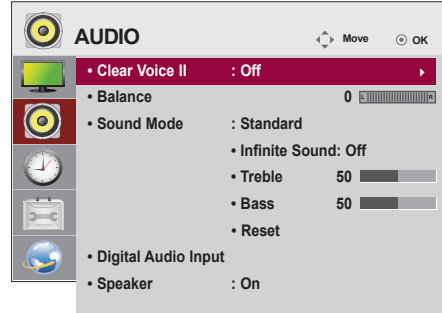

The available audio options are described in the following:

Setting	Description
<b>Clear Voice II</b>	By differentiating the human sound range from others, it helps users to hear human voices better.
<b>Balance</b>	Adjusts balance between the left and right speakers according to your room environment.
<b>Sound Mode</b>	The best sound tone quality will be selected automatically depending on the video type that you're currently watching.
<b>Mode</b>	
Standard	The most commanding and natural audio.
Music	Select this option to enjoy the original sound when listening to the music.
Cinema	Select this option to enjoy sublime sound.
Sport	Select this option to watch sports broadcasting.
Game	To enjoy dynamic sound when playing a game.
<div style="border: 1px solid black; padding: 10px; margin-top: 10px;"> <p><b>NOTE</b></p> <ul style="list-style-type: none"> <li>If sound quality or volume is not at the level you want, it is recommended to use a separate home theater system or amplifier to cope with different user environments.</li> </ul> </div>	
<b>Option</b>	
Infinite Sound	LG's Infinity Sound option provides 5.1 channel stereo sound from two speakers.
Treble	Controls the dominant sounds in the output. When you turn up the treble, it will increase the output to the higher frequency range.
Bass	Makes the output sound softer. When you turn up the bass, it will increase the output to the lower Frequency.
Reset	Resets the sound mode to the default setting.
<b>Digital Audio Input</b>	<b>HDMI/Display Port:</b> Outputs the sound of digital signal from HDMI/ Display Port through the monitor speaker. <b>Audio In:</b> Outputs the sound through the monitor speaker by connecting HDMI/ Display Port to the Audio In port.
<b>Speaker</b>	<b>ON:</b> Enables sound to the monitor speaker. (* The monitor speaker is sold separately.) <b>OFF:</b> Disables sound to the monitor speaker. Use this option when using an external sound device.

## TIME Settings

- 1 Press **SETTINGS** to access the main menus.
- 2 Press the navigation buttons to scroll to **TIME** and press **OK**.
- 3 Press the navigation buttons to scroll to the setting or option you want and press **OK**.
  - To return to the previous level, press **BACK**.
- 4 When you are finished, press **EXIT**.
  - When you return to the previous menu, press **BACK**.

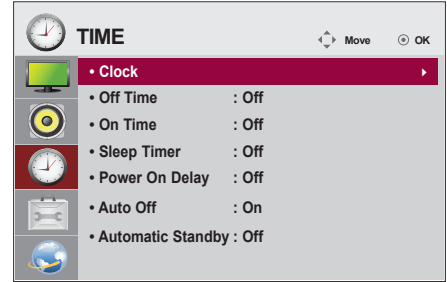

The available time settings are described in the following:

Setting	Description
<b>Clock</b>	Sets the time feature.
<b>On/Off Time</b>	Sets the time to turn on or off the monitor set.
<b>Sleep Timer</b>	Sets the length of time until the monitor set to turns off. When you turn the monitor set off and turn it on again, the Sleep Timer will be set to off.
<b>Power on delay</b>	When connecting multiple monitors and turning the power on, the monitors are turned on individually to prevent overload.
<b>Auto off</b>	If Auto off is active and there is no input signal, the set switches to off mode automatically after 15 minutes.
<b>Automatic Standby</b>	If you do not use the monitor for more than 4 hours, it will be in standby mode automatically.

### ! NOTE

- Off Time/On Time can be saved for up to seven schedules; the monitor is turned on or off at the preset time in the schedule list. If multiple preset times are stored in the schedule list, this function works at the nearest time from the current time.
- Once the on or off time is set, these functions operate daily at the preset time.
- The scheduled power-off function works properly only when the device time is set correctly.
- When the scheduled power-on and power-off times are the same, the power-off time has priority over the power-on time if the set is turned on, and vice versa if the set is turned off.

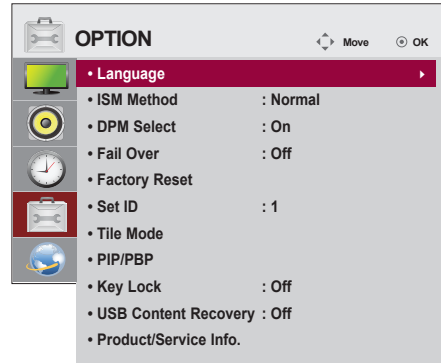

## OPTION Settings

- 1 Press **SETTINGS** to access the main menus.
- 2 Press the navigation buttons to scroll to **OPTION** and press **OK**.
- 3 Press the navigation buttons to scroll to the setting or option you want and press **OK**.
  - To return to the previous level, press **BACK**.
- 4 When you are finished, press **EXIT**.  
When you return to the previous menu, press **BACK**.



The available option settings are described in the following:

Setting	Description	
<b>Language</b>	To choose the language in which the control names are displayed.	
<b>ISM Method</b>	A frozen or still picture from a PC/Video game displayed on the screen for prolonged periods could result in a image burn remaining even when you change the image. Avoid allowing a fixed image to remain on the screen for a long period of time.	
	<b>Setting</b>	
	Normal	Leave on normal if you don't foresee image burn in being a problem.
	Orbiter	May help prevent image burn. However, it is best not to allow any fixed image to remain on the screen. To avoid a permanent image on the screen, the screen will move every 2 minutes.
	Inversion	This function inverts the panel color of the screen. The panel color is automatically inverted every 30 minutes.
White Wash	White wash fills the screen with solid white. This helps removes permanent images burned into the screen. A permanent image may be impossible to clear entirely with white wash.	
<b>DPM Select</b>	A user can choose to turn the power saving mode on / off. <div style="border: 1px solid black; padding: 10px; margin-top: 10px;"> <p><b>NOTE</b></p> <ul style="list-style-type: none"> <li>You can set Energy Saving to Off or set the length of time before entering Energy Saving mode to 5 sec./10 sec./15 sec./1 min./3 min./5 min./10 min.</li> <li>It makes a little difference according to your environment.</li> <li>It may not be supported depending on the model.</li> </ul> </div>	
<b>Fail Over</b>	If there is no input signal, it automatically switches to another input with signal.	
	<b>Setting</b>	
	Off	Stops auto switch of the input source.
	Auto	Switches to another input source with video signal if no video signal comes from the current input source.
Manual	Selects the priority of input source for auto switch. When several input sources are found, the input source with a higher priority will be selected.	
<b>Factory Reset</b>	Select this option to return to the default factory settings.	
<b>Set ID</b>	You can assign a unique Set ID NO (name assignment) to each product when several products are connected for display. Specify the number (1 to 255) using the button and exit. Use the assigned Set ID to individually control each product using the Product Control Program.	

Setting	Description	
<b>Tile Mode</b>	Tile Mode	To use this function - Must be displayed with various other products. - Must be in a function that can be connected to DVI Cable and distributor. Tile mode and choose Tile alignment and set the ID of the current product to set location. * Only after pressing the SET button the adjustments made to the settings will be saved. - Tile mode : column x row ( c = 1 to 15 r = 1 to 15) - 15 x 15 available. - Configuration of an integration screen is also available as well as configuration of One by one Display.
	Auto Config.	Sets to adjust the screen position, clock, and phase automatically. The displayed image may be unstable for a few seconds while the configuration is in progress.
	Position	Moving the screen position horizontally and vertically.
	Size	Adjust the horizontal and vertical size of the screen taking into account the size of the bezel.
	Natural	The image is omitted by the distance between the screens to be naturally shown.
	Reset	Function to initialize and release Tile. All Tile setting are released when selecting Tile recall and the screen returns to Full screen.
	<div style="border: 1px solid black; border-radius: 10px; padding: 10px;"> <p> <b>NOTE</b></p> <ul style="list-style-type: none"> <li>The touch screen feature is limited while using Tile Mode.</li> </ul> </div>	
<b>PIP/PBP</b>	Displays videos or photos stored in the USB device on a single monitor by dividing it into the main and sub screens.	
	<b>Option</b>	
	Mode	Sets the type of secondary screen. * <b>OFF</b> : Disables the secondary screen. * <b>PIP (Picture In Picture)</b> : Displays the secondary screen in the main screen. * <b>PBP (Picture By Picture)</b> : Displays the secondary screen next to the main screen.
	Position	Adjusts the position of the sub screen (top left, bottom left, top right, bottom right) The default value is the bottom right.
	Size	Adjusts the size of the sub screen (Size 0 to 10). The default size of PIP (Size: 0) is 480x270; the maximum size 10 is 960x540.
	<div style="border: 1px solid black; border-radius: 10px; padding: 10px;"> <p> <b>NOTE</b></p> <ul style="list-style-type: none"> <li>The Position and Size options are enabled only in PIP mode.</li> </ul> </div>	
<b>Key Lock</b>	Turns the local key function on or off. If Key Lock is enabled, the local key does not work.	
<b>USB Content Recovery</b>	Replays the content in a USB when the power is back on if it is turned off during playing a content. (This function operates the same when a USB is disconnected and connected again.)	
<b>Product/Service Info.</b>	Displays the model name, software version, serial number, IP address, MAC address, and home page.	



**Tile Mode**

This monitor can be tiled with additional monitors to create a large tiled display.

**Off**  
When the Tile Mode option is disabled

**1X2**  
When using 2 monitors

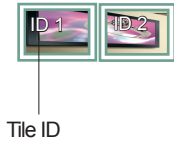

**2X2**  
When using 4 monitors



**3X3**  
When using 9 monitors



**4X4**  
When using 16 monitors



**5X5**  
When using 25 monitors



**Tile Mode - Natural mode**

When active, the part of the image that would normally be displayed in the gap between the monitors is omitted.

Before



After



**PIP/PBP**

Displays videos or photos stored in the USB device on a single monitor by dividing it into the main and sub screens. (See page 40.)

**Mode**

\***PIP (Picture In Picture):** Displays the Sub screen in the main screen.

\***PBP (Picture By Picture):** Displays the Sub screen next to the main screen.

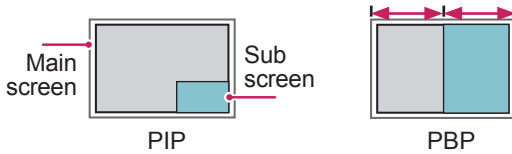

**Position**

Adjusts the position of the subscreen (top left, bottom left, top right, bottom right)

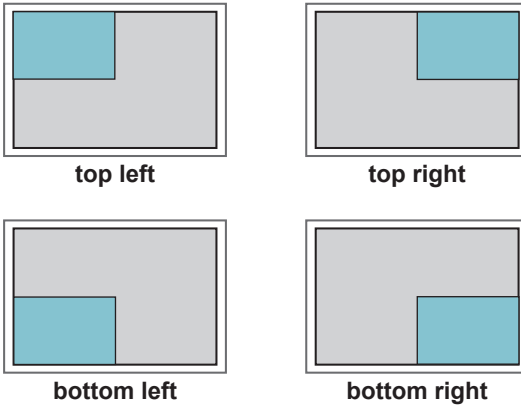

**Size**

Adjusts the size of the subscreen (Size 0-10).

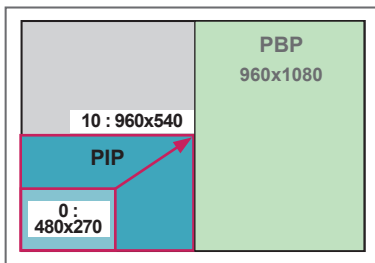

< 1920x1080 >

**NOTE**

- The subscreen is only supported when using the USB device.

		Sub
		USB
Main	AV	X
	Component	O
	RGB	O
	HDMI/ DVI-D/ DP	O

- You can only change the size and position in PIP mode.
- With PBP selected, the Aspect Ratio option in the PICTURE menu is disabled (Fixed as 16:9).
- While running the PIP/PBP function, the Tile Mode function does not work.
- You must select the output sound before running the PIP or PBP functions. (Select either Main or Sub.)
- If you fail to select Main or Sub from the sound selection box, and if the OSD disappears after either a period of time or when the Exit or Back key is pressed, the PIP/PBP subscreen is not activated.
- You cannot change the sound while running the PIP or PBP functions. If you want to change the sound, please restart PIP/PBP.
- The picture quality of the subscreen is set according to the values selected in the main menu, not the USB device.
- If you play videos you selected in PIP/PBP mode, the videos will play back repeatedly in succession.
- The buttons below work in PIP mode.

Button	Photo	Movie
◀	O	X
▶	O	X
▶	X	O
■	X	X
▶▶	X	O
◀◀	X	O
⏸	X	O

## Picture ID Settings

**Picture ID** is used to change the settings of a specific display using a single IR receiver for multi-vision. Communication is possible between a monitor with an IR receiver and other monitors using RS232C cables. Each monitor is identified by a **Set ID**. If you assign the **Picture ID** using the remote control, only displays with the same **Picture ID** and **Set ID** can be controlled remotely.

- 1 Assign the **Set ID** to the installed monitors as shown below:

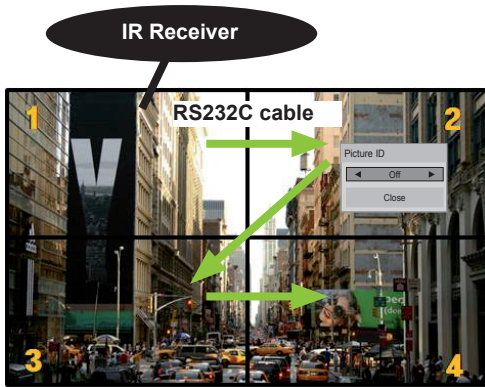

2X2 Multi-Vision (Total Set ID: 4)  
Set IDs are assigned as shown in the picture.

- 2 Press the **ON** (Red) button on the remote control to assign the **PICTURE ID**.

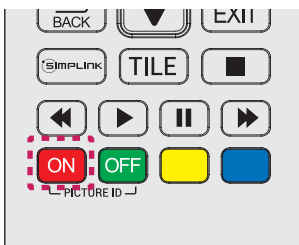

- 3 If you press the left/right buttons or the red ON button for **PICTURE ID** repeatedly, the **Picture ID** toggles between **OFF** and 1 to 4. Assign the **Set ID** as you like.

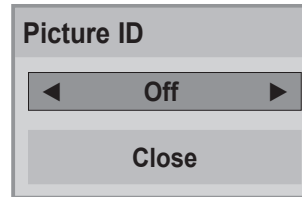

- A set with a different **Set ID** than the **Picture ID** cannot be controlled by IR signals.
- Please refer to the **Installation Manual** for more information on the assigning **Total Set ID**.

### NOTE

- If **Picture ID** is set to 2, the upper right monitor, that has a **Set ID** of 2, can be controlled by IR signals.
- If you press the green **OFF** button for **PICTURE ID**, the **Picture IDs** for all monitors are turned off. If you then press any button on the remote control, all monitors can be controlled by IR signals regardless of **Set ID**.
- The **Picture ID** function may not work while **MY MEDIA** is operating.

## NETWORK Settings

- 1 Press **SETTINGS** to access the main menus.
- 2 Press the navigation buttons to scroll to **NETWORK** and press **OK**.
- 3 Press the navigation buttons to scroll to the setting or option you want and press **OK**.
  - To return to the previous level, press **BACK**.
- 4 When you are finished, press **EXIT**.
  - When you return to the previous menu, press **BACK**.

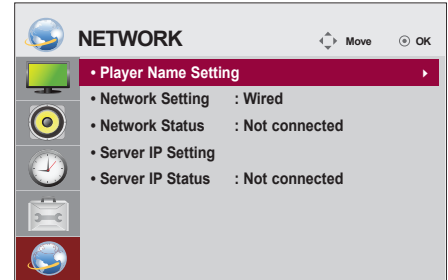

The available option settings are described in the following:

Setting	Description
<b>Player Name Setting</b>	Sets the player name used in SuperSign Manager. (Up to 20 characters)
<b>Network Setting</b>	Configure the network settings.
<b>Network Status</b>	Display the network status. - Internet is connected : Externally connected - Home network is connected : Only internally connected - Not connected : When there is no network connection
<b>Server IP Setting</b>	Sets the IP address of the computer (server) on which SuperSign Manager is installed.
<b>Server IP Status</b>	Displays the connection status with the server. - Not connected : When there is no network connection with SuperSign server. - Waiting for approval : When network connection with SuperSign server has been made, but access to server has not been approved by the server. - Rejected : When network connection with SuperSign server has been made, but access to server has been rejected by the server. - Internet is connected : When network connection with SuperSign server has been made and access to server has also been approved by the server.



### CAUTION

- When setting the **Player Name**, press the remote buttons one at a time to avoid an input error.

# MAKING CONNECTIONS

Connect various external devices to the ports on the monitor set's back panel.

- 1 Find an external device you want to connect to your monitor set shown on the following illustration.
- 2 Check the connection type of the external device.
- 3 Go to the appropriate illustration and check the connection details.

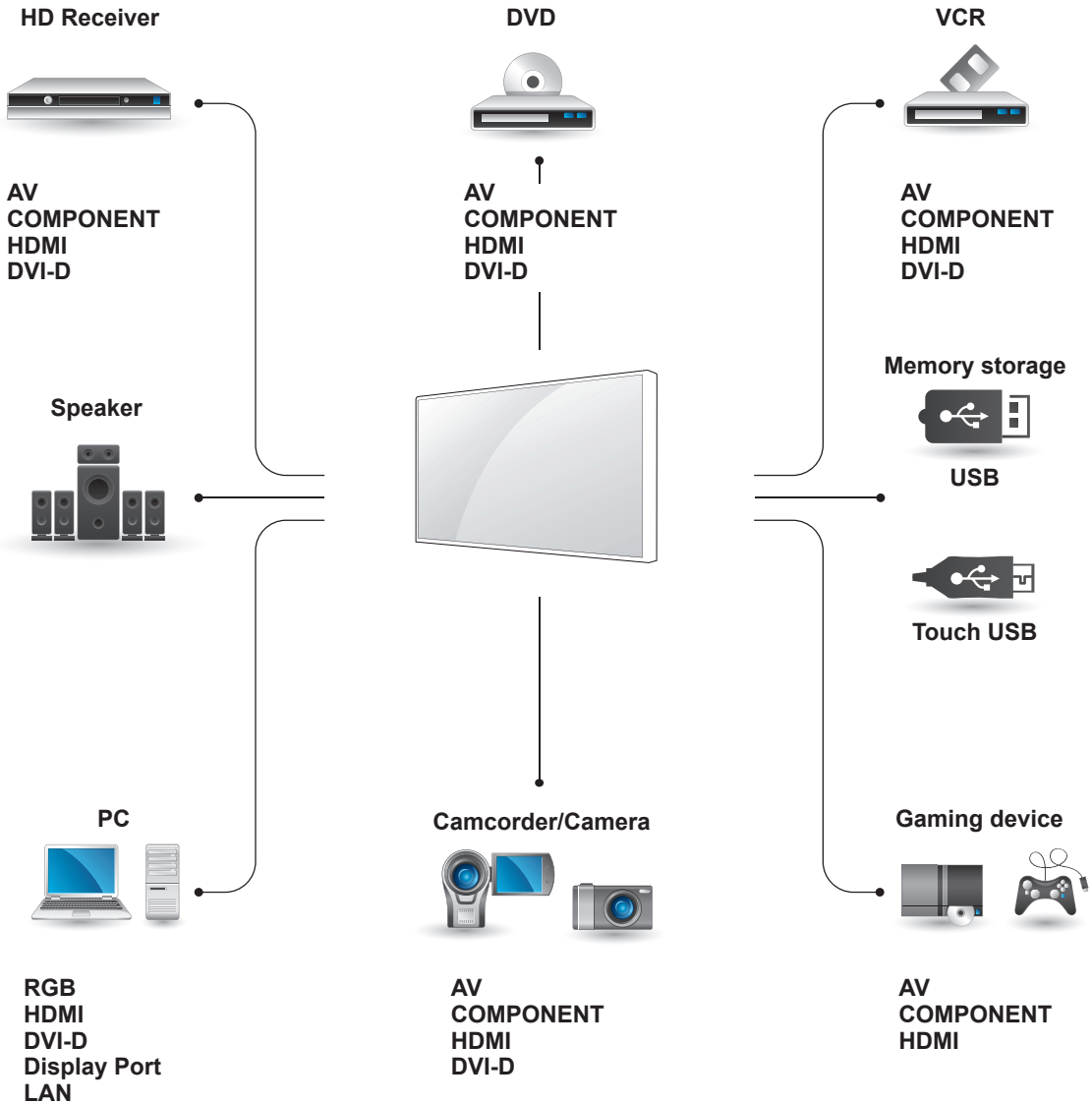

**NOTE**

- If you connect a gaming device to the monitor set, use the cable supplied with the gaming device.
- It is recommended you to use the optional speaker provided.

## External Device Connection

Connect a HD receiver, DVD, or VCR player to the monitor set and select an appropriate input mode.

## AV (CVBS) Connection

Transmits the analog video and audio signals from an external device to the monitor. Connect the external device and the monitor with the 15 pin signal to RCA cable as shown on the following illustration.

## COMPONENT Connection

Transmits the analog video and audio signals from an external device to the monitor set. Connect the external device and the monitor set with the 15 pin signal to RCA cable as shown on the following illustration. To display images by using progressive scan, make sure to use the component cable.

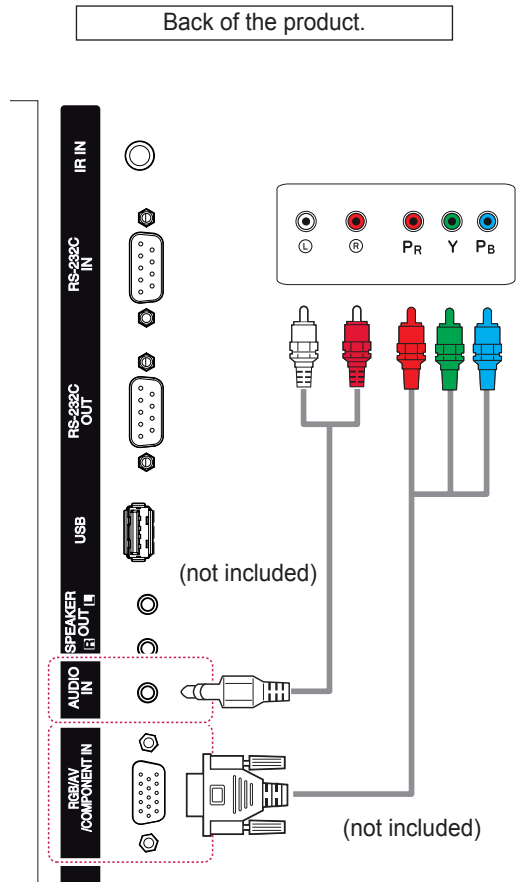
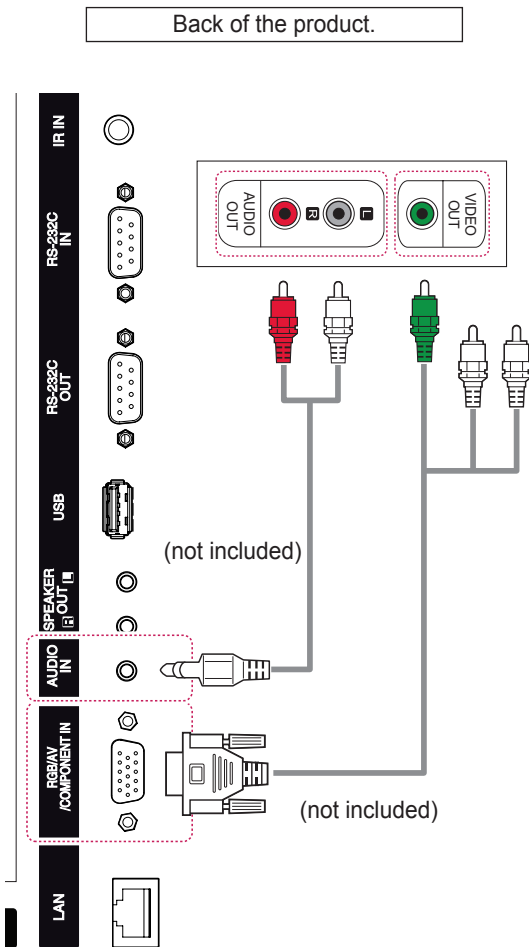

**NOTE**

- When connecting to the component port using the shared interface, the port must match to the input source. Otherwise, noise may occur.

## HDMI Connection

Transmits the digital video and audio signals from an external device to the monitor set. Connect the external device and the monitor set with the HDMI cable as shown on the following illustration.

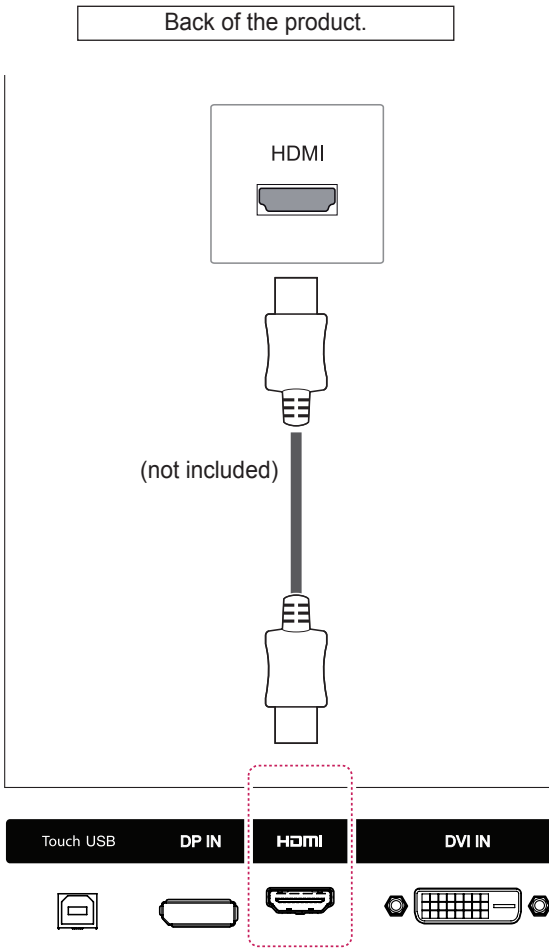

## DVI Connection

Transmits the digital video signal from an external device to the monitor set. Connect the external device and the monitor set with the DVI cable as shown in the following illustration. To transmit an audio signal, connect an optional audio cable.

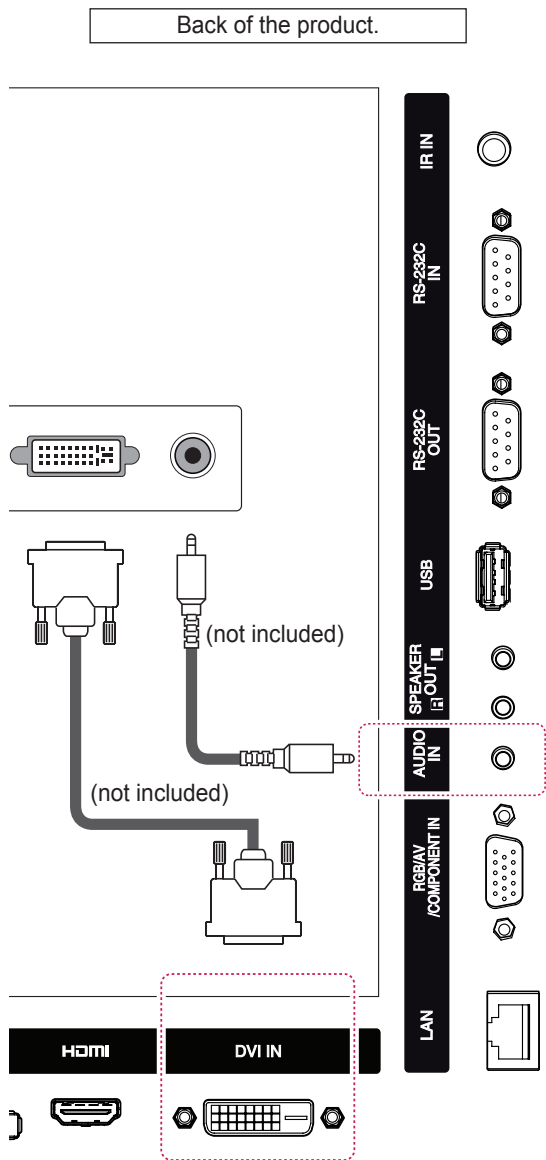

**NOTE**

- Use a High Speed HDMI™ Cable.
- High Speed HDMI™ Cables are tested to carry an HD signal up to 1080p and higher.

## USB Connection

Connect a USB storage device such as a USB flash memory, external hard drive, MP3 player or a USB memory card reader to the monitor set and access the USB menu to use various multimedia files.

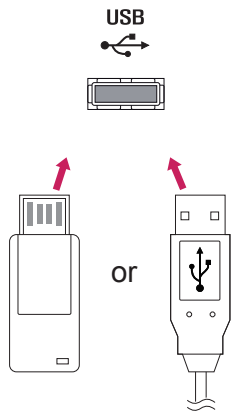

## LAN Connection

### A Using a router (Switch)

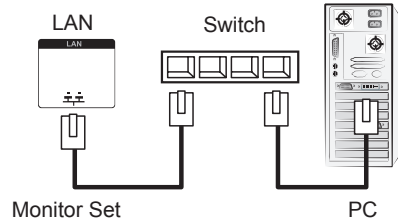

### B Using the Internet.

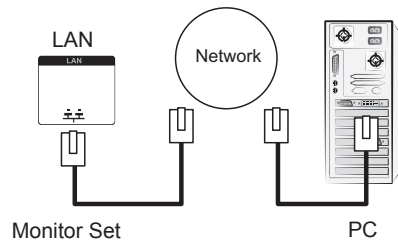



# USING THE TOUCH SCREEN

## To Use the Touch Screen on Windows 7

Plug a USB cable into the Touch USB port on the back of the monitor.

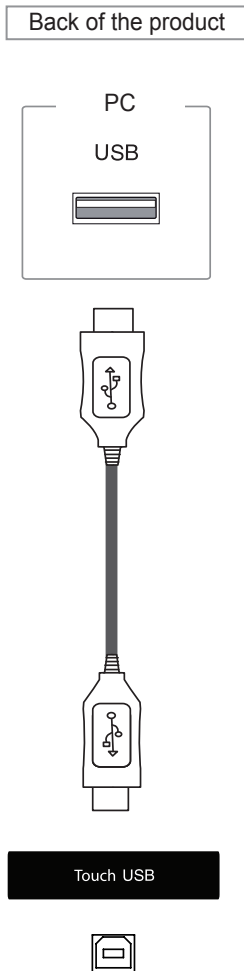

Then, connect the USB cable to your PC so that it automatically recognizes the touch screen monitor.

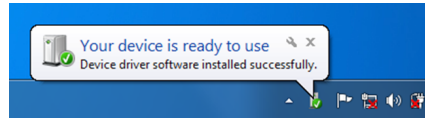

Go to Control Panel > System and Security > System. You will see the number of touch-points supported under Pen and Touch.

### CAUTION

- Once your PC recognizes the monitor, you will be able to use the touch screen.

### NOTE

- The monitor can respond to 10 Touch Points when connected to a Windows 7 computer.
- When using the touch screen monitor, it is recommended to set the screen aspect ratio to Just Scan.
- For more information about gestures and settings on Windows 7, refer to Windows Help.

## Gestures and Settings on Windows 7

For information about gestures and settings on Windows 7, refer to the Windows Help.

## To Use the Touch Screen on Windows XP

Plug a USB cable into the Touch USB port on the back of the monitor.

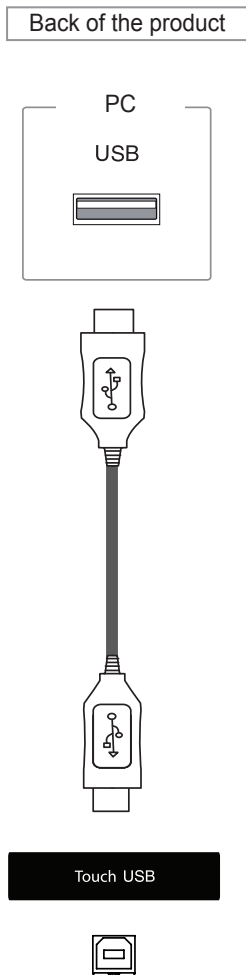

Then, connect the USB cable to your PC so that it automatically recognizes the touch screen monitor.

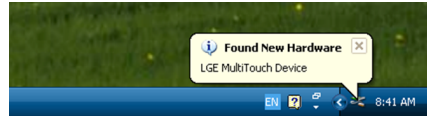

### CAUTION

- Once your PC recognizes the monitor, you will be able to use the touch screen.

You can see the details of the current touch screen on the Device Manager window. Go to Control Panel > System > Hardware > Device Manager > Human Interface Devices.

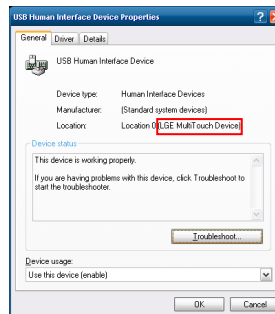

You can see **LGE MultiTouch Device** on the USB Human Interface Device Properties window.

## Touch Response to Windows XP

Touch: Mouse click (action)

Long-press: Mouse right click (context menu)

\* The touch screen monitor is optimized for Windows 7.



### NOTE

- The monitor can respond to one Touch Point when connected to a Windows XP computer.
- When using the touch screen monitor, it is recommended to set the screen aspect ratio to Just Scan.
- The touch function only works for the screen that is set as the primary monitor. Go to Control Panel > Display > Settings > Use this device as the primary monitor.

## How to Use LG TDS

LG TDS is required to enable portrait mode and the long-touch on Windows XP.

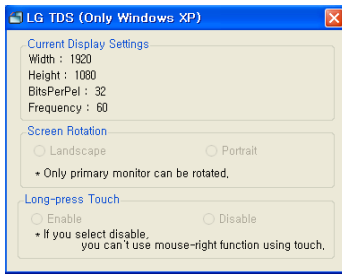

## LG TDS Detailed Function Settings

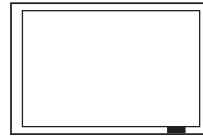

Landscape

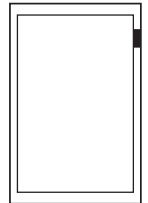

Portrait

\*Portrait mode supports only a 90° counterclockwise screen rotation.

- **Current Display Settings**

Displays the current screen information.

- **Screen Rotation**

Touch Screen Rotation Settings

- **Long-press Touch**

Whether to enable the mouse's right click function (context menu), when you touch and hold the screen.

\* **Enable:** Enables the mouse's right click function (context menu) when a long-touch is applied.

\* **Disable:** Disables the mouse's right click function (context menu).

### ! NOTE

- LG TDS is only supported in Windows XP.
- You must install .NET Framework 3.5 on Windows XP before installing this program.

## Precautions When Using the Touch Screen



### CAUTION

- The monitor is optimized for indoor use.
- The touch screen monitor is optimized for Windows 7.
- Do not remove the USB cable when using the touch screen monitor.
- Use LG TDS(Touch Display Settings) provided with the monitor to set touch coordinates when rotating the monitor connected to a Windows XP computer.
- The LG TDS provided with the monitor only supports the following graphic cards: nVidia, AMD (ATI) and Intel.
- If touch does not respond, remove the USB cable and connect it back in ten seconds.
- Touch responds when the monitor is powered on.
- Up to 10 touch-points are supported when the monitor is connected to a Windows 7 computer; one when connected to a Windows XP computer.
- Set the monitor as the primary monitor in Windows XP.
- Touch accuracy is optimized by using full screen mode.
- Your action may not work properly on the edge area of the touch screen.
- If the 10 touch-points are not detected, restart your PC. (Windows 7)
- The touch operation (e.g. touches count, gesture, etc.) may vary depending on the content.
- The spot that you try to touch and the one which is actually touched on the screen may differ depending on the angle you view the monitor screen.

# TROUBLESHOOTING

## No image is displayed

Problem	Resolution
Is the product power cord connected?	<ul style="list-style-type: none"> <li>See if the power cord is properly connected to the outlet.</li> </ul>
Does the <b>Out of range</b> message appear?	<ul style="list-style-type: none"> <li>The signal from the PC (video card) is out of the vertical or horizontal frequency range of the product. Adjust the frequency range by referring to the Specifications in this manual. * Maximum resolution 1920 x 1080 @ 60 Hz</li> </ul>
Does the Check signal cable message appear?	<ul style="list-style-type: none"> <li>The signal cable between PC and product is not connected. Check the signal cable.</li> <li>Press the <b>INPUT</b> menu in the remote Control to check the input signal.</li> </ul>

## 'Unknown Product' message appears when the product is connected.

Problem	Resolution
Did you install the driver?	<ul style="list-style-type: none"> <li>See if the plug&amp;play function is supported by referring to the video card user manual.</li> </ul>

## 'Key Lock On' message appears.

Problem	Resolution
The <b>Key Lock On</b> message appears when pressing the Menu button.	<ul style="list-style-type: none"> <li>The Lock function prevents the OSD settings from being changed inadvertently. To release the lock, go to Menu and Option and disable the Key Lock option.</li> </ul>

**The screen image looks abnormal.**

Problem	Resolution
Is the screen position wrong?	<ul style="list-style-type: none"> <li>• D-Sub analog signal - Press the AUTO button in the remote control to automatically select the optimal screen status that fits into the current mode. If adjustment is not satisfactory, use the Position OSD menu.</li> <li>• See if the video card resolution and frequency are supported by the product. If the frequency is out of range, set to the recommended resolution in the Control Panel Display Setting menu.</li> </ul>
Do thin lines appear on the background screen?	<ul style="list-style-type: none"> <li>• D-Sub analog signal - Press the AUTO button in the remote control to automatically select an optimal screen status that fits into the current mode. If adjustment is not satisfactory, use the Clock OSD menu.</li> </ul>
Horizontal noise appears or the characters look blurred.	<ul style="list-style-type: none"> <li>• D-Sub analog signal - Press the AUTO button in the remote control to automatically select an optimal screen status that fits into the current mode. If adjustment is not satisfactory, use the Phase OSD menu.</li> </ul>
The screen is displayed abnormally.	<ul style="list-style-type: none"> <li>• The proper input signal is not connected to the signal port. Connect the signal cable that matches with the source input signal.</li> </ul>

**After-image appears on the product.**

Problem	Resolution
After-image appears when the product is turned off.	<ul style="list-style-type: none"> <li>• If you use a fixed image for a long time, the pixels may be damaged quickly. Use the screen-saver function.</li> <li>• When a dark image is displayed on the screen after an image with high contrast (black and white or gray), this may cause image sticking. This is normal for LCD screen.</li> </ul>

**The audio function does not work.**

Problem	Resolution
No sound?	<ul style="list-style-type: none"> <li>• See if the audio cable is connected properly.</li> <li>• Adjust the volume.</li> <li>• See if the sound is set properly.</li> </ul>
Sound is too dull.	<ul style="list-style-type: none"> <li>• Select the appropriate equalize sound.</li> </ul>
Sound is too low.	<ul style="list-style-type: none"> <li>• Adjust the volume.</li> </ul>

**Screen color is abnormal.**

Problem	Resolution
Screen has poor color resolution (16 colors).	<ul style="list-style-type: none"> <li>• Set the number of colors to more than 24 bits (true color) Select Control Panel - Display - Settings - Color Table menu in Windows.</li> </ul>
Screen color is unstable or mono-colored.	<ul style="list-style-type: none"> <li>• Check the connection status of the signal cable. Or, re-insert the PC video card.</li> </ul>
Do black spots appear on the screen?	<ul style="list-style-type: none"> <li>• Several pixels (red, green, white or black color) may appear on the screen, which can be attributable to the unique characteristics of the LCD panel. It is not a malfunction of the LCD.</li> </ul>

**The operation does not work normally.**

Problem	Resolution
The power suddenly turned off.	<ul style="list-style-type: none"> <li>• Is the sleep timer set?</li> <li>• Check the power control settings. Power interrupted.</li> </ul>



**I have a problem with touch response.**

Problem	Resolution
Touch does not respond.	<ul style="list-style-type: none"> <li>• Check the USB cable connection.               <ul style="list-style-type: none"> <li>- This may occur when the USB cable between PC and monitor is not connected. Check the USB cable and make it firmly connected.</li> </ul> </li> <li>* Check the connection on Windows 7               <ul style="list-style-type: none"> <li>Control Panel &gt; System and Security &gt; System</li> </ul> </li> <li>- Check the number of touch-points supported under Pen and Touch.</li> <li>* Check the connection on Windows XP               <ul style="list-style-type: none"> <li>Go to Control Panel &gt; System &gt; Hardware &gt; Device Manager &gt; Human Interface Devices.</li> <li>You need to be able to see <b>LGE MultiTouch Device</b> on the USB Human Interface Device Properties window.</li> </ul> </li> <li>• Check the PC power.               <ul style="list-style-type: none"> <li>- This may occur when the PC is powered off. Make sure that your PC's power cord is firmly plugged into a power outlet.</li> </ul> </li> <li>• Restart your PC.               <ul style="list-style-type: none"> <li>- Touch may not respond when the system is down due to the unstable network. Reconnect the LAN cable or restart your PC.</li> </ul> </li> <li>• Check the signal cable connection.               <ul style="list-style-type: none"> <li>- If your PC and monitor are not connected using a signal cable, touch does not respond. Check the signal cable connection.</li> </ul> </li> <li>• Check the monitor power.               <ul style="list-style-type: none"> <li>- Touch may not respond when the monitor is powered off.</li> </ul> </li> <li>• Check if the screen is currently on.</li> </ul>
The location of a touch does not correspond to the touch coordinates.	<ul style="list-style-type: none"> <li>• Change your tablet PC settings (Windows 7).               <ul style="list-style-type: none"> <li>- This may occur when the touch screen is not calibrated properly. Control Panel &gt; Hardware and Sound &gt; Tablet PC Settings &gt; Display &gt; Display options &gt; Calibrate or Reset</li> </ul> </li> <li>* For information about gestures and settings on Windows 7, refer to the Windows Help.</li> <li>• Change the display setting to Full Screen (Windows XP).               <ul style="list-style-type: none"> <li>- On Windows XP, rotation of touch coordinates works only in full screen mode.</li> <li>* Refer to help of the graphic card installed on your PC.</li> </ul> </li> </ul>
Touch coordinates appear to be rotated 90 degrees (Windows XP).	<ul style="list-style-type: none"> <li>• Change the Screen Rotation setting with LG TDS.               <ul style="list-style-type: none"> <li>- Run the LG TDS provided with the monitor and set to Landscape or Portrait.</li> </ul> </li> <li>• When using HDMI, set the Input Label to PC.</li> </ul>
I cannot start LG TDS.	<ul style="list-style-type: none"> <li>• Check whether the operating system is Windows XP.               <ul style="list-style-type: none"> <li>- LG TDS is supported only in Windows XP.</li> </ul> </li> <li>• Please install .NET Framework 3.5.               <ul style="list-style-type: none"> <li>- You can download it at Microsoft Download Center.</li> </ul> </li> </ul>



Problem	Resolution
A touch is applied to a monitor other than the one I intended.	<ul style="list-style-type: none"> <li>• Change your tablet PC settings (Windows 7).               <ul style="list-style-type: none"> <li>- This may occur when the touch screen is not calibrated properly. Go to Control Panel &gt; Hardware and Sound &gt; Tablet PC Settings &gt; Display &gt; Display options &gt; Calibrate or Reset</li> </ul> </li> <li>• Set the monitor as the default monitor (Windows XP).               <ul style="list-style-type: none"> <li>- This may occur if the monitor is not set as the default monitor when you are using multiple monitors. Go to Control Panel &gt; Display &gt; Settings tab &gt; Select the monitor &gt; Use this device as the primary monitor (U) &gt; Apply (A)</li> </ul> </li> </ul>
I cannot use 10 touch points in Windows 7.	<ul style="list-style-type: none"> <li>• Make sure that you use a content that supports up to 10 touch points.               <ul style="list-style-type: none"> <li>- The content played (e.g. Flash Player, Paint, etc.) may not support 10 touch points.</li> </ul> </li> <li>• Remove the USB cable and connect it again in 10 seconds.</li> <li>• Run the content (e.g. Flash Player, Paint, etc.) again.</li> <li>• Restart your PC.</li> <li>• If the gap between two touch points is 15 mm or less, a touch error may occur.</li> <li>• On the edge of the touch screen, 10 touch points may be less reliable.</li> </ul>

# SPECIFICATIONS

42WT30MS

LCD Panel	Screen Type	1064.67 mm Wide TFT (Thin Film Transistor) LCD (Liquid Crystal Display) Panel. Visible diagonal size : 1064.67 mm
	Pixel Pitch	0.4833 mm (H) x 0.4833 mm (V)
Video Signal	Max. Resolution	1920 x 1080 @ 60 Hz - It may not be supported depending on the OS or video card type.
	Recommended Resolution	1920 x 1080 @ 60 Hz - It may not be supported depending on the OS or video card type.
	Horizontal Frequency	RGB : 30 kHz to 83 kHz HDMI/ DVI-D/ DP : 30 kHz to 83 kHz
	Vertical Frequency	RGB : 50 Hz to 75 Hz HDMI/ DVI-D/ DP : 56 Hz to 60 Hz
	Synchronization Type	Separate Sync, Composite Sync, Digital
Input Connector		15-pin D-Sub, DVI, HDMI, DP, Component, Audio, Speaker, IR, USB, RS-232C, LAN, Touch USB - Using a RGB cable can connect the output connector of AV(CVBS) or component.
Power	Power Rating	AC 100-240 V~ 50/60 Hz 1.3 A
	Power Consumption	On Mode : 90 W Typ. Sleep Mode (RGB/HDMI/DVI) : ≤ 0.7 W Sleep Mode (DP) : ≤ 0.7 W Off Mode : ≤ 0.5 W
Environmental conditions	Operating Temperature	0 °C to 40 °C
	Operating Humidity	10 % to 80 %
	Storage Temperature	-20 °C to 60 °C
	Storage Humidity	5 % to 95 %

Product specifications shown above may be changed without prior notice due to upgrade of product functions.

Dimensions (Width x Height x Depth) / Weight		
	990.9 mm x 585 mm x 95.3 mm / 15.9 kg	
		
	990.9 mm x 585 mm x 95.3 mm / 16.7 kg	

#### \* Touch Screen

OS (Operating System)	Windows XP	1 Point
	Windows 7	10 Points
	Space between touches : at least 15 mm or more	

#### \* Applicable only for models that support the speakers



Audio	RMS Audio Output	10 W + 10 W (R + L)
	Input Sensitivity	0.7 Vrms
	Speaker Impedance	8 Ω

Product specifications shown above may be changed without prior notice due to upgrade of product functions.

## 47WT30MS

LCD Panel	Screen Type	1192.78 mm Wide TFT (Thin Film Transistor) LCD (Liquid Crystal Display) Panel. Visible diagonal size : 1192.78 mm
	Pixel Pitch	0.5415 mm (H) x 0.5415 mm (V)
Video Signal	Max. Resolution	1920 x 1080 @ 60 Hz - It may not be supported depending on the OS or video card type.
	Recommended Resolution	1920 x 1080 @ 60 Hz - It may not be supported depending on the OS or video card type.
	Horizontal Frequency	RGB : 30 kHz to 83 kHz HDMI/ DVI-D/ DP : 30 kHz to 83 kHz
	Vertical Frequency	RGB : 50 Hz to 75 Hz HDMI/ DVI-D/ DP : 56 Hz to 60 Hz
	Synchronization Type	Separate Sync, Composite Sync, Digital
Input Connector		15-pin D-Sub, DVI, HDMI, DP, Component, Audio, Speaker, IR, USB, RS-232C, LAN, Touch USB - Using a RGB cable can connect the output connector of AV(CVBS) or component.
Power	Power Rating	AC 100-240 V~ 50/60 Hz 1.3 A
	Power Consumption	On Mode : 100 W Typ. Sleep Mode (RGB/HDMI/DVI) : ≤ 0.7 W Sleep Mode (DP) : ≤ 0.7 W Off Mode : ≤ 0.5 W
Environmental conditions	Operating Temperature	0 °C to 40 °C
	Operating Humidity	10 % to 80 %
	Storage Temperature	-20 °C to 60 °C
	Storage Humidity	5 % to 95 %

Product specifications shown above may be changed without prior notice due to upgrade of product functions.

Dimensions (Width x Height x Depth) / Weight	
	1102.7 mm x 647.8 mm x 100.7 mm / 20.5 kg
	
	1102.7 mm x 647.8 mm x 100.7 mm / 21.3 kg

**\* Touch Screen**

OS (Operating System)	Windows XP	1 Point
	Windows 7	10 Points
	Space between touches : at least 15 mm or more	

**\* Applicable only for models that support the speakers**



Audio	RMS Audio Output	10 W + 10 W (R + L)
	Input Sensitivity	0.7 Vrms
	Speaker Impedance	8 Ω

Product specifications shown above may be changed without prior notice due to upgrade of product functions.

## 55WT30MS

LCD Panel	Screen Type	1387.80 mm Wide TFT (Thin Film Transistor) LCD (Liquid Crystal Display) Panel. Visible diagonal size : 1387.80 mm
	Pixel Pitch	0.630 mm (H) x 0.630 mm (V)
Video Signal	Max. Resolution	1920 x 1080 @ 60 Hz - It may not be supported depending on the OS or video card type.
	Recommended Resolution	1920 x 1080 @ 60 Hz - It may not be supported depending on the OS or video card type.
	Horizontal Frequency	RGB : 30 kHz to 83 kHz HDMI/ DVI-D/ DP : 30 kHz to 83 kHz
	Vertical Frequency	RGB : 50 Hz to 75 Hz HDMI/ DVI-D/ DP : 56 Hz to 60 Hz
	Synchronization Type	Separate Sync, Composite Sync, Digital
Input Connector		15-pin D-Sub, DVI, HDMI, DP, Component, Audio, Speaker, IR, USB, RS-232C, LAN, Touch USB - Using a RGB cable can connect the output connector of AV(CVBS) or component.
Power	Power Rating	AC 100-240 V~ 50/60 Hz 1.8 A
	Power Consumption	On Mode : 140 W Typ. Sleep Mode (RGB/HDMI/DVI) : ≤ 0.7 W Sleep Mode (DP) : ≤ 0.7 W Off Mode : ≤ 0.5 W
Environmental conditions	Operating Temperature	0 °C to 40 °C
	Operating Humidity	10 % to 80 %
	Storage Temperature	-20 °C to 60 °C
	Storage Humidity	5 % to 95 %

Product specifications shown above may be changed without prior notice due to upgrade of product functions.

Dimensions (Width x Height x Depth) / Weight	
	1272.6 mm x 743.4 mm x 100.4 mm / 28 kg
	
	1272.6 mm x 743.4 mm x 100.4 mm / 28.8 kg

#### \* Touch Screen

OS (Operating System)	Windows XP	1 Point
	Windows 7	10 Points
	Space between touches : at least 15 mm or more	

#### \* Applicable only for models that support the speakers

Audio	RMS Audio Output	10 W + 10 W (R + L)
	Input Sensitivity	0.7 Vrms
	Speaker Impedance	8 Ω

Product specifications shown above may be changed without prior notice due to upgrade of product functions.



**Dimensions**

The illustrations in this manual may differ from the actual product and accessories. Please see the Mounting on a Wall section for sizes of screws.

42WT30MS

(Unit : mm)

ENGLISH

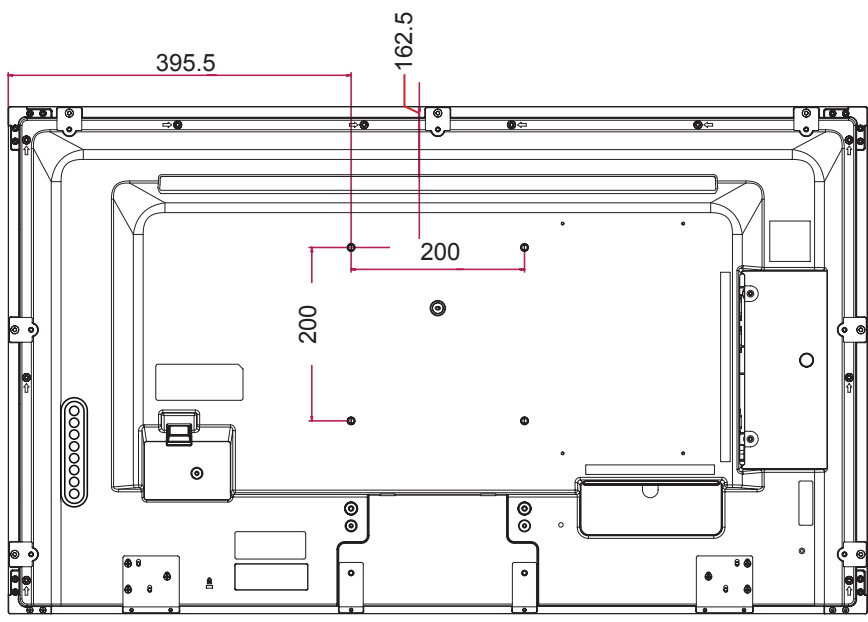
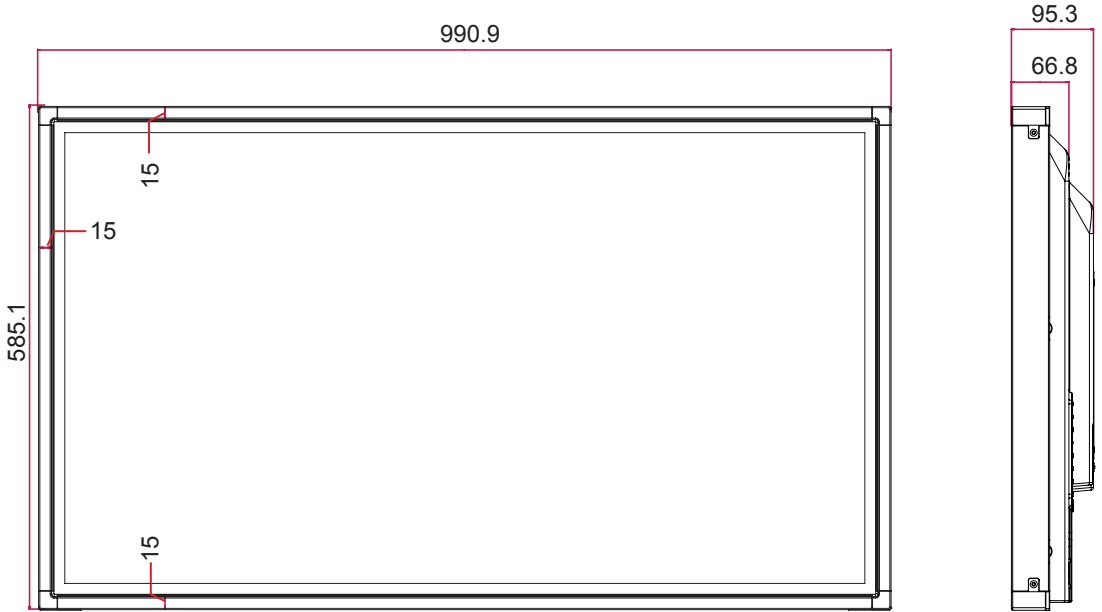

Product specifications shown above may be changed without prior notice due to upgrade of product functions.

**Dimensions**

The illustrations in this manual may differ from the actual product and accessories. Please see the Mounting on a Wall section for sizes of screws.

47WT30MS

(Unit : mm)

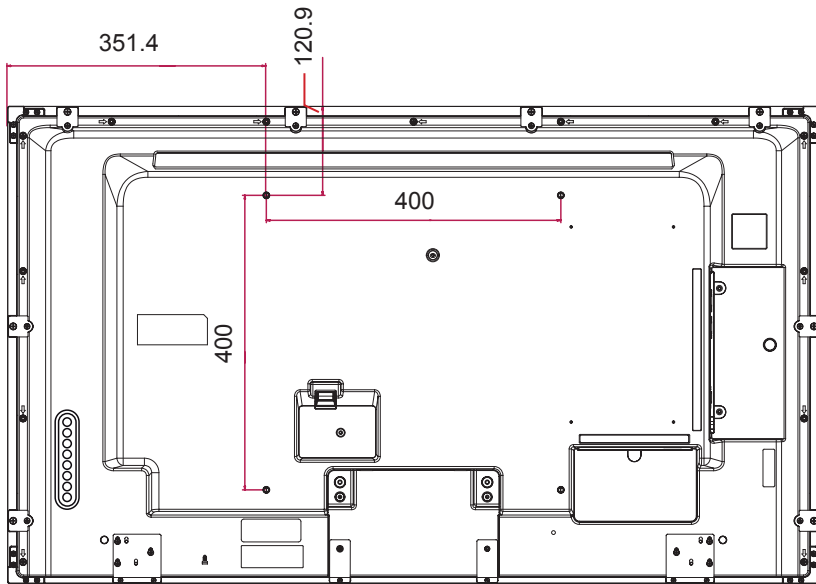
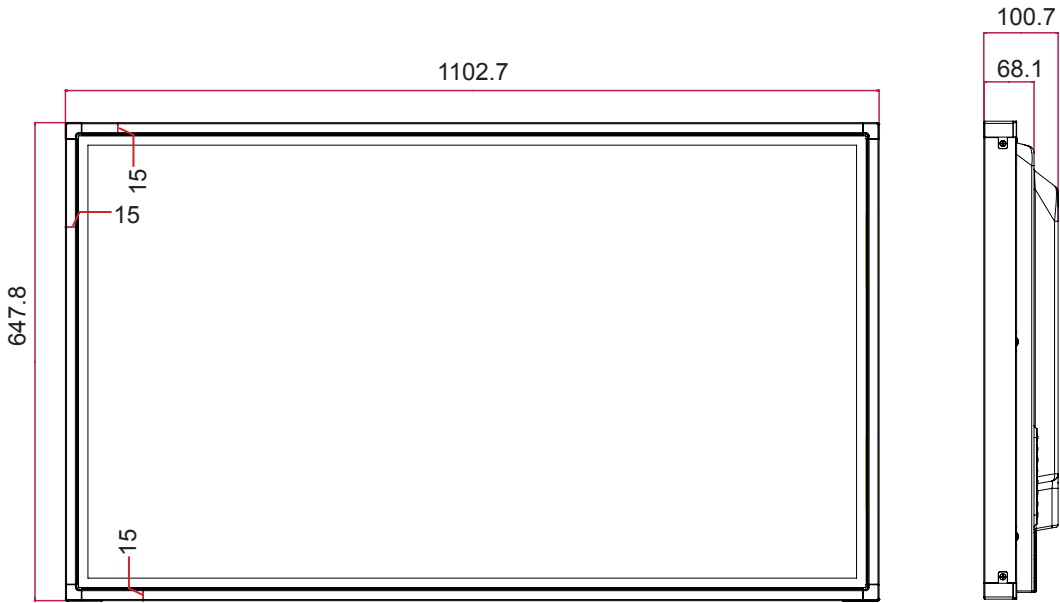

Product specifications shown above may be changed without prior notice due to upgrade of product functions.

**Dimensions**

The illustrations in this manual may differ from the actual product and accessories. Please see the Mounting on a Wall section for sizes of screws.

55WT30MS

(Unit : mm)

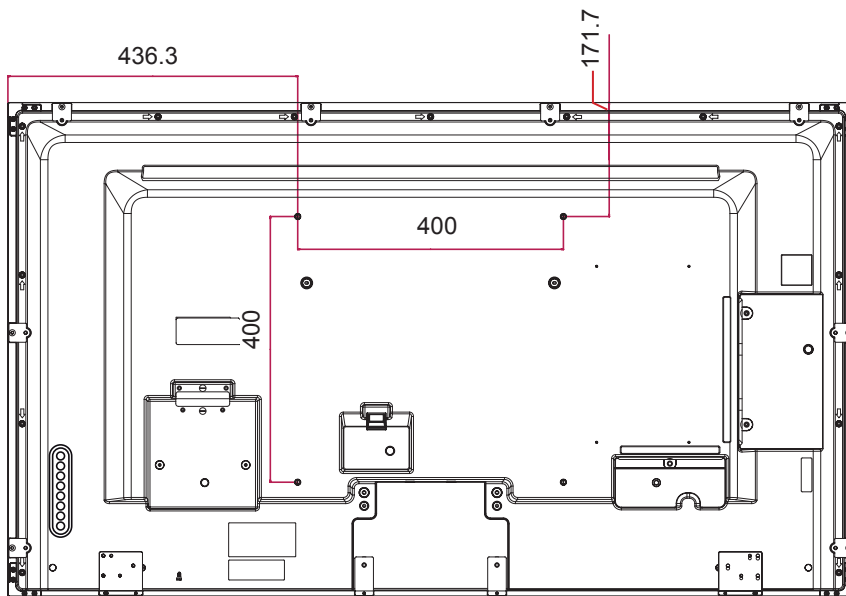
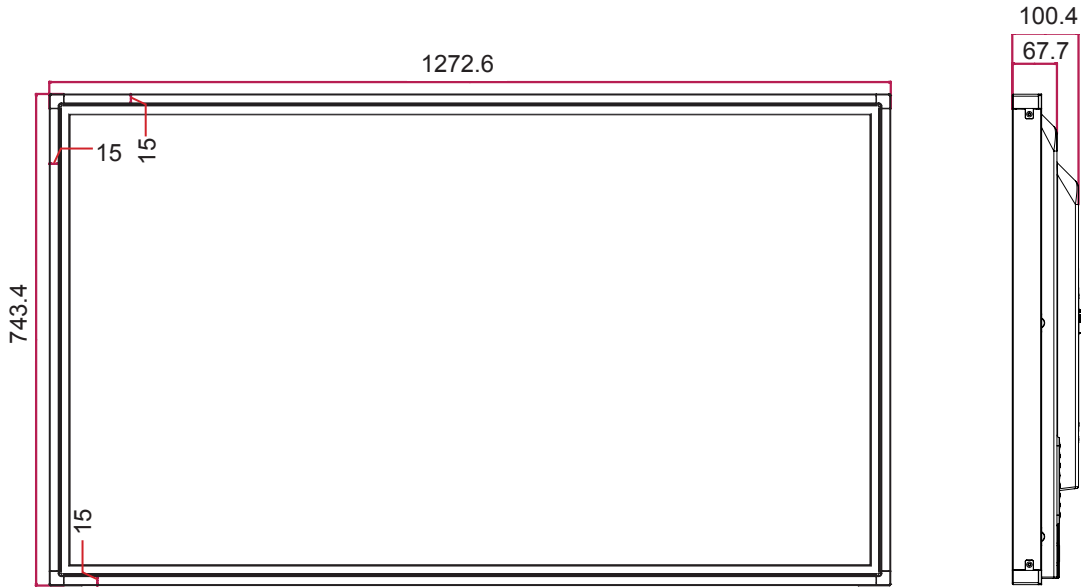

Product specifications shown above may be changed without prior notice due to upgrade of product functions.

## RGB (PC) supported mode

Resolution	Horizontal Frequency(kHz)	Vertical Frequency(Hz)
640 x 350	31.469	70.8
720 x 400	31.468	70.8
640 x 480	31.469	59.94
800 x 600	37.879	60.317
832 x 624	49.725	74.55
1024 x 768	48.363	60
1280 x 720	44.772	59.855
1366 x 768	47.7	60
1280 x 1024	63.981	60.02
1680 x 1050	65.290	59.954
1920 x 1080	67.5	60

## DTV Mode

Resolution	Component	HDMI/ Display Port (DTV)
480i	o	x
576i	o	x
480p	o	o
576p	o	o
720p	o	o
1080i	o	o
1080p	o	o

## HDMI/ DVI/ Display Port(PC) supported mode

Resolution	Horizontal Frequency(kHz)	Vertical Frequency(Hz)
640 x 480	31.469	59.94
800 x 600	37.879	60.317
1024 x 768	48.363	60
1280 x 720	44.772	59.855
1366 x 768	47.7	60
1280 x 1024	63.981	60.02
1680 x 1050	65.290	59.954
1920 x 1080	67.5	60

**!** NOTE

- PC resolutions available as the input label option in RGB and HDMI/DVI/Display Port input mode : 640 x 480 / 60 Hz, 1280 x 720 / 60 Hz, 1920 x 1080 / 60 Hz and DTV resolutions : 480p, 720p, 1080p.

**!** NOTE

- Vertical frequency: To enable the user to watch the product display, screen image should be changed tens of times every second like a fluorescent lamp. The vertical frequency or refresh rate is the times of image display per second. The unit is Hz.
- Horizontal frequency: The horizontal interval is the time to display one vertical line. When 1 is divided by the horizontal interval, the number of horizontal lines displayed every second can be tabulated as the horizontal frequency. The unit is kHz.

# IR CODES

- All models do not support the HDMI/USB function.
- Some key codes are not supported, depending on the model.

Code (Hexa)	Function	Note
08	⏻ Power	R/C BUTTON
0B	INPUT	R/C BUTTON
C4	MONITOR ON	R/C BUTTON
C5	MONITOR OFF	R/C BUTTON
95	ENERGY SAVING	R/C BUTTON
DC	3D	R/C BUTTON
10 to 19	Number Key 0 to 9	R/C BUTTON
32	1/a/A	R/C BUTTON
2F	CLEAR	R/C BUTTON
02	Volume ▲ ( + )	R/C BUTTON
03	Volume ▼ ( - )	R/C BUTTON
79	ARC	R/C BUTTON
99	AUTO	R/C BUTTON
09	MUTE	R/C BUTTON
E0	BRIGHTNESS ▲ (Page UP)	R/C BUTTON
E1	BRIGHTNESS ▼ (Page Down)	R/C BUTTON
4D	PSM	R/C BUTTON
AA	INFO ⓘ	R/C BUTTON
5F	W.BAL	R/C BUTTON
43	SETTINGS	R/C BUTTON
40	Up ▲	R/C BUTTON
41	Down ▼	R/C BUTTON
07	Left ◀	R/C BUTTON
06	Right ▶	R/C BUTTON
3F	S.MENU	R/C BUTTON
44	OK	R/C BUTTON
28	BACK	R/C BUTTON
5B	EXIT	R/C BUTTON
7E	ⓈIMPLINK	R/C BUTTON
7B	TILE (Tile Mode)	R/C BUTTON
B1	■	R/C BUTTON
B0	▶	R/C BUTTON
BA		R/C BUTTON
8F	◀◀	R/C BUTTON
8E	▶▶	R/C BUTTON
72	Red Key (PICTURE ID ON)	R/C BUTTON
71	Green Key (PICTURE ID OFF)	R/C BUTTON
63	Yellow Key	R/C BUTTON
61	Blue Key	R/C BUTTON

# CONTROLLING THE MULTIPLE PRODUCT

- Use this method to connect several products to a single PC. You can control several products at a time by connecting them to a single PC.
- In the Option menu, Set ID must be between 1 and 255 without being duplicated.

## Connecting the Cable

Connect the RS-232C cable as shown in the picture.

- The RS-232C protocol is used for communication between the PC and product. You can turn the product on/off, select an input source or adjust the OSD menu from your PC.

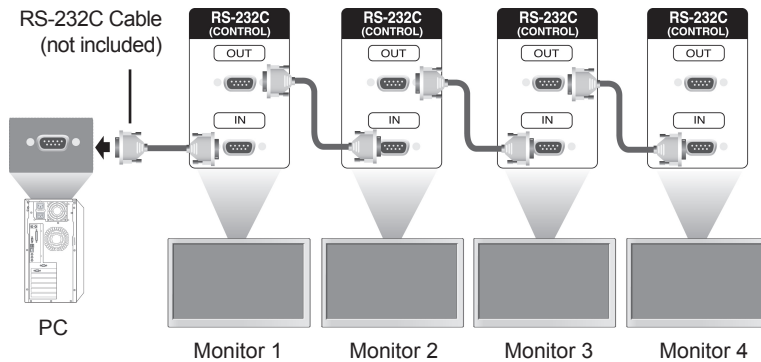

## RS-232C Configurations

### 7-Wire Configurations (Standard RS-232C cable)

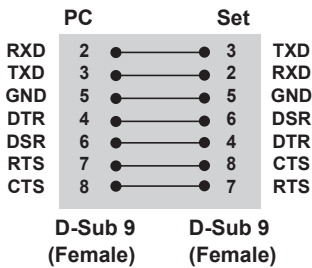

### 3-Wire Configurations (Not Standard)

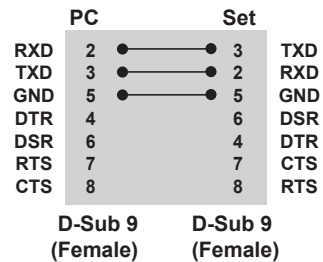

## Communication Parameter

- Baud Rate : 9600 BPS
- Data Length : 8 bit
- Parity Bit : None
- Stop Bit : 1bit
- Flow Control : None
- Communication Code : ASCII code
- Use a crossed (reverse) cable

## Command Reference List

	COMMAND		DATA (Hexadecimal)
	1	2	
01. Power	k	a	00 to 01
02. Input Select	x	b	Refer to 'Input Select.'
03. Aspect Ratio	k	c	Refer to 'Aspect Ratio.'
04. Energy Saving	j	q	Refer to 'Energy Saving.'
05. Picture mode	d	x	Refer to 'Picture mode.'
06. Contrast	k	g	00 to 64
07. Brightness	k	h	00 to 64
08. Sharpness	k	k	00 to 64
09. Color	k	i	00 to 64
10. Tint	k	j	00 to 64
11. Color Temperature	x	u	00 to 64
12. H Position	f	q	00 to 64
13. V Position	f	r	00 to 64
14. H Size	f	s	00 to 64
15. Auto configuration	j	u	01
16. Balance	k	t	00 to 64
17. Sound mode	d	y	Refer to 'Sound mode.'
18. Treble	k	r	00 to 64
19. Bass	k	s	00 to 64
20. Speaker	d	v	00 to 01
21. Volume Mute	k	e	00 to 01
22. Volume Control	k	f	00 to 64
23. Time 1(Years/ Months/ Days)	f	a	Refer to 'Time 1.'
24. Time 2(Hours/ Minutes/Seconds)	f	x	Refer to 'Time 2.'
25. Off Timer(Repeat mode/ Time)	f	e	Refer to 'Off Timer.'
26. On Timer(Repeat Mode/ Time)	f	d	Refer to 'On Timer.'
27. On Timer Input	f	u	Refer to 'On Timer Input.'
28. Sleep Time	f	f	00 to 08
29. Power On Delay	f	h	00 to 64
30. Automatic Standby	m	n	00 to 01
31. Auto Off	f	g	00 to 01
32. Language	f	i	Refer to 'Language.'
33. Power Indicator(Standby Light)	f	o	00 to 01
34. Power Indicator(Power Light)	f	p	00 to 01
35. ISM mode	j	p	Refer to 'ISM Method.'
36. Fail Over Select	m	i	00 to 02
37. Fail Over Input Select	m	j	Refer to 'Fail Over Input Select.'
38. Reset	f	K	00 to 02

	COMMAND		DATA (Hexadecimal)
	1	2	
39. Tile Mode	d	d	00 to 01
40. Tile Mode Check	d	z	FF
41. Tile ID	d	i	Refer to 'Tile ID.'
42. Tile H Position	d	e	00 to 32
43. Tile V Position	d	f	00 to 32
44. Tile H Size	d	g	00 to 32
45. Tile V Size	d	h	00 to 32
46. Natural Mode (In Tile mode)	d	j	00 to 01
47. DPM Select	f	j	00 to 01
48. FAN Control	d	o	00 to 03
49. FAN Fault Check	d	w	FF
50. Temperature Value	d	n	FF
51. Remote Lock/ key Lock	k	m	00 to 01
52. Key	m	c	Refer to 'Key.'
53. OSD Select	k	l	00 to 01
54. Elapsed time return	d	l	FF
55. Serial No. Check	f	y	FF
56. S/W Version	f	z	FF
57. White Balance Red Gain	j	m	00 to FE
58. White Balance Green Gain	j	n	00 to FE
59. White Balance Blue Gain	j	o	00 to FE
60. Backlight	m	g	00 to 64
61. PC Power Control	d	t	00 to 01
62. PC Power	d	s	00 to 01
63. Easy Brightness Control Mode	s	m	00 to 01
64. Easy Brightness Control Schedule	s	s	Refer to 'Easy Brightness Control Schedule.'
65. Status check	s	v	Refer to 'Status check.'
66. BLU Maintenance	m	t	00 to 01
67. Screen mute	k	d	00 to 01

- Note : During USB operations such as Dvix or EMF, all commands except Power (k a) and Key (m c) are not executed and treated as NG.
- Some commands are not supported depending on the model.
- The 'f' command which shows the status of a certain command does not display the OSD as the result in order to be compatible with SuperSign program.



## Transmission / Receiving Protocol

### Transmission

[Command1][Command2][ ][Set ID][ ][Data][Cr]

- \* [Command1]: First command to control the set.
- \* [Command2]: Second command to control the set.
- \* [Set ID]: Set ID with which you want to communicate. Enter [Set ID] = '00(0 x 00)' to communicate with all sets regardless of their Set ID numbers.
- \* [Data]: Information passed to the set.
- \* [Data1]: Information passed to the set.
- \* [Data2]: Information passed to the set.
- \* [Data3]: Information passed to the set.
- \* [Cr]: Carriage Return. ASCII code '0 x 0D'.
- \* [ ]: ASCII code space '0 x 20'

### Acknowledgement

[Command2][ ][Set ID][ ][OK/NG][Data][x]

- \* When the product receives data normally, it sends an acknowledgement (ACK) in the format above. If data is in read mode, it indicates the data that shows the current status. If data is in read mode, it simply indicates the data that is sent from the PC.
- \* If a command is sent with Set ID '00' (=0 x 00), the data is reflected to all monitor sets and they do send any acknowledgement (ACK).
- \* If the data value 'FF' is sent in control mode via RS-232C, the current setting value of a function can be checked (only for some functions).
- \* Some commands are not supported depending on the model.

**01. Power (Command: k a)**

To control the Power On/Off the display.

Transmission

[k][a][ ][Set ID][ ][Data][Cr]

Data 00 : Off

01 : On

Acknowledgement

[a][ ][Set ID][ ][OK/NG][Data][x]

\* Only when the monitor set is fully powered on, the Acknowledgement signal is returned properly.

\* There may be a certain time of delay between the Transmission and Acknowledgement signals.

**02. Input Select (Command: x b)**

To select the Input Source for display.

Transmission

[x][b][ ][Set ID][ ][Data][Cr]

Data 20: Input (AV)

40: Component

60: RGB

70: DVI-D(PC)

80: DVI-D(DTV)

90: HDMI(HDMI1)(DTV)

A0: HDMI(HDMI1)(PC)

C0: Display Port(DTV)

D0: Display Port(PC)

91: HDMI2/SDI(DTV)

A1: HDMI2/SDI(PC)

B0: SuperSign

Acknowledgement

[b][ ][Set ID][ ][OK/NG][Data][x]

\* Some input signals may not be supported depending on the model.

**03. Aspect Ratio (Command: k c)**

To adjust the screen format.

Transmission

[k][c][ ][Set ID][ ][Data][Cr]

Data 01: 4:3

02: 16:9

04: Zoom

(AV, Component, HDMI/ DVI-D/ Display Port DTV)

09: Just scan (720p or more)

(Component, HDMI/ DVI-D/ Display Port DTV)

\* RGB, DVI-D, HDMI/Display Port PC mode (1:1)

10 to 1F: Cinema Zoom 1 to 16

(AV, Component, HDMI/ DVI-D/ Display Port DTV)

\* Available data types differ depending on the input signal. For more information, see the aspect ratio section of the owner's manual.

\* The aspect ratio may differ depending on the model's input configuration.

Acknowledgement

[c][ ][Set ID][ ][OK/NG][Data][x]

**04. Energy Saving (Command: j q)**

To set the Energy Saving function.

Transmission

[j][q][ ][Set ID][ ][Data][Cr]

Data 00: Off

01: Minimum

02: Medium

03: Maximum

04: Auto

05: Screen Off

Acknowledgement

[q][ ][Set ID][ ][OK/NG][Data][x]

\*\* It may not be supported depending on the model.

**05. Picture Mode (Command: d x)**

To select the Picture Mode.

Transmission

[d][x][ ][Set ID][ ][Data][Cr]

Data 00: Vivid

01: Standard

02: Cinema

03: Sport

04: Game

Acknowledgement

[x][ ][Set ID][ ][OK/NG][Data][x]

**06. Contrast (Command: k g)**

To adjust the screen contrast.

Transmission

[k][g][ ][Set ID][ ][Data][Cr]

Data 00 to 64: Contrast 0 to 100

Acknowledgement

[g][ ][Set ID][ ][OK/NG][Data][x]

**07. Brightness (Command: k h)**

To adjust the screen brightness.

Transmission

[k][h][ ][Set ID][ ][Data][Cr]

Data 00 to 64: Brightness 0 to 100

Acknowledgement

[h][ ][Set ID][ ][OK/NG][Data][x]

**08. Sharpness (Command: k k)**

To adjust the screen sharpness.

\* This function is available only in AV/Component input.

Transmission

[k][k][ ][Set ID][ ][Data][Cr]

Data 00 to 64: Sharpness 0 to 100

Acknowledgement

[k][ ][Set ID][ ][OK/NG][Data][x]

**09. Color (Command: k i)**

To adjust the screen color.

\* This function is available only in AV/Component input.

Transmission

[k][i][ ][Set ID][ ][Data][Cr]

Data 00 to 64: Color 0 to 100

Acknowledgement

[i][ ][Set ID][ ][OK/NG][Data][x]

**10. Tint (Command: k j)**

To adjust the screen tint.

\* This function is available only in AV/Component input.

Transmission

[k][j][ ][Set ID][ ][Data][Cr]

Data 00 to 64: Tint R50 to G50

Acknowledgement

[j][ ][Set ID][ ][OK/NG][Data][x]

**11. Color Temperature (Command: x u)**

To adjust the screen Color Temperature.

Transmission

[x][u][ ][Set ID][ ][Data][Cr]

Data 00 to 64: Warm 50 to Cool 50

Acknowledgement

[u][ ][Set ID][ ][OK/NG][Data][x]

**12. H Position (Command: f q)**

To adjust the screen Horizontal Position.

\* This function is available only when the Tile Mode is set to Off.

\* The operational range varies depending on the RGB input resolution.

(Only available for RGB-PC input.)

Transmission

[f][q][ ][Set ID][ ][Data][Cr]

Data 00 to 64: min. -50 (Left) to max. 50 (Right)

Acknowledgement

[q][ ][Set ID][ ][OK/NG][Data][x]

**13. V Position (Command: f r)**

To adjust the screen Vertical Position.

\* This function is available only when the Tile Mode is set to Off.

\* The operational range varies depending on the RGB input resolution.

(Only available for RGB-PC input.)

Transmission

[f][r][ ][Set ID][ ][Data][Cr]

Data 00 to 64: min. -50 (Bottom) to max. 50 (Top)

Acknowledgement

[r][ ][Set ID][ ][OK/NG][Data][x]

**14. H Size (Command: f s)**

To adjust the screen Horizontal Size.

\* This function is available only when the Tile Mode is set to Off.

\* The operational range varies depending on the RGB input resolution.

(Only available for RGB-PC input.)

Transmission

[f][s][ ][Set ID][ ][Data][Cr]

Data 00 - 64: Min. -50 (Reduce) - Max. 50 (Expand)

Acknowledgement

[s][ ][Set ID][ ][OK/NG][Data][x]

**15. Auto Configuration (Command: j u)**

To adjust the picture position and minimize image shaking automatically.

(Only available for RGB-PC input.)

Transmission

[j][u][ ][Set ID][ ][Data][Cr]

Data 01 : Set

Acknowledgement

[u][ ][Set ID][ ][OK/NG][Data][x]

**16. Balance (Command: k t)**

To adjust the sound balance.

Transmission

[k][t][ ][Set ID][ ][Data][Cr]

Data 00 to 64: Left 50 to Right 50

Acknowledgement

[t][ ][Set ID][ ][OK/NG][Data][x]

**17. Sound Mode (Command: d y)**

To select the Sound Mode.

Transmission

[d][y][ ][Set ID][ ][Data][Cr]

Data 01: Standard

02: Music

03: Cinema

04: Sport

05: Game

Acknowledgement

[y][ ][Set ID][ ][OK/NG][Data][x]

**18. Treble (Command: k r)**

To adjust the Treble values.

Transmission

[k][r][ ][Set ID][ ][Data][Cr]

Data 00 to 64: Treble 0 to 100

Acknowledgement

[r][ ][Set ID][ ][OK/NG][Data][x]

**19. Bass (Command: k s)**

To adjust the Bass values.

Transmission

[k][s][ ][Set ID][ ][Data][Cr]

Data 00 to 64: Bass 0 to 100

Acknowledgement

[s][ ][Set ID][ ][OK/NG][Data][x]

**22. Volume Control (Command: k f)**

To set the playback volume.

Transmission

[k][f][ ][Set ID][ ][Data][Cr]

Data 00 to 64: Volume 0 to 100

Acknowledgement

[f][ ][Set ID][ ][OK/NG][Data][x]

**20. Speaker (Command: d v)**

To select the speaker on/off.

Transmission

[d][v][ ][Set ID][ ][Data][Cr]

Data 00: Off

01: On

Acknowledgement

[v][ ][Set ID][ ][OK/NG][Data][x]

**23. Time 1 (Year/ Month/ Day) (Command: f a)**

To set the Time 1 (Year/ Month/ Day) values.

Transmission

[f][a][ ][Set ID][ ][Data1][ ][Data2][ ][Data3][Cr]

Data 1 00 to 14: 2010 to 2030

Data 2 01 to 0C: January to December

Data 3 01 to 1F: 1 to 31

\* Enter "fa [Set ID] ff" for checking Time 1 (Year/ Month/ Day) values.

Acknowledgement

[a][ ][Set ID][ ][OK/NG][Data1][Data2][Data3][x]

**21. Volume Mute (Command: k e)**

To control the Volume Mute on/off.

Transmission

[k][e][ ][Set ID][ ][Data][Cr]

Data 00 : Mute (Volume Off)

01 : Current volume (Volume On)

Acknowledgement

[e][ ][Set ID][ ][OK/NG][Data][x]

**24. Time 2 (Hour/ Minute/ Second) (Command: f x)**

To set the Time 2 (Hour/ Minute/ Second) values.

Transmission

[f][x][ ][Set ID][ ][Data1][ ][Data2][ ][Data3][Cr]

Data1 00 to 17: 00 to 23 hours

Data2 00 to 3B: 00 to 59 minutes

Data3 00 to 3B: 00 to 59 seconds

\* Enter "fx [Set ID] ff" for checking Time 2 (Hour/ Minute/ Second) values.

\*\* This command won't work if Time 1 (Year/ Month/ Day) has not been set in advance.

Acknowledgement

[x][ ][Set ID][ ][OK/NG][Data1][Data2][Data3][x]

**25. Off Timer(Repeat Mode/ Time) (Command: f e)**

To set the Off Timer(Repeat Mode/ Time) function.

**Transmission**

[f][e][ ][Set ID][ ][Data1][ ][Data2][ ][Data3][Cr]

**Data1**

1. F1 to F7 (Read data)

F1: Read the 1st Off Time data

F2: Read the 2nd Off Time data

F3: Read the 3rd Off Time data

F4: Read the 4th Off Time data

F5: Read the 5th Off Time data

F6: Read the 6th Off Time data

F7: Read the 7th Off Time data

2. E1-E7 (Delete one index), E0 (Delete all indexes)

E0: Delete all Off Time data

E1: Delete the 1st Off Time data

E2: Delete the 2nd Off Time data

E3: Delete the 3rd Off Time data

E4: Delete the 4th Off Time data

E5: Delete the 5th Off Time data

E6: Delete the 6th Off Time data

E7: Delete the 7th Off Time data

3. 01 to 0C (Set the day of week for Off Time)

00: Off

01: Once

02: Daily

03: Monday to Friday

04: Monday to Saturday

05: Saturday to Sunday

06: Sunday

07: Monday

08: Tuesday

09: Wednesday

0A: Thursday

0B: Friday

0C: Saturday

Data2 00 to 17: 00 to 23 Hours

Data3 00 to 3B: 00 to 59 Minutes

\* To read or delete the Off Time list, set FFH for [Data2] and [Data3].

(Example 1: fe 01 f1 ff ff - Read the 1st Off Time data.)

(Example 2: fe 01 e1 ff ff - Delete the 1st Off Time data.)

(Example 3: fe 01 04 02 03 - Set the Off Time to "Monday to Saturday, 02:03".)

\* This function is supported only when 1 (Year/Month/Day) and 2 (Hour/Minute/Second) are set.

**Acknowledgement**

[e][ ][Set ID][ ][OK/NG][Data1][Data2][Data3][x]

**26. On Timer(Repeat Mode/ Time) (Command: f d)**

To set the On Timer(Repeat mode/ Time) function.

**Transmission**

[f][d][ ][Set ID][ ][Data1][ ][Data2][ ][Data3][Cr]

**Data1**

1. F1 to F7 (Read data)

F1: Read the 1st On Time data

F2: Read the 2nd On Time data

F3: Read the 3rd On Time data

F4: Read the 4th On Time data

F5: Read the 5th On Time data

F6: Read the 6th On Time data

F7: Read the 7th On Time data

2. E1-E7 (Delete one index), E0 (Delete all indexes)

E0: Delete all On Time data

E1: Delete the 1st On Time data

E2: Delete the 2nd On Time data

E3: Delete the 3rd On Time data

E4: Delete the 4th On Time data

E5: Delete the 5th On Time data

E6: Delete the 6th On Time data

E7: Delete the 7th On Time data

3. 01 to 0C (Set the day of week for On Time)

00: Off

01: Once

02: Daily

03: Monday to Friday

04: Monday to Saturday

05: Saturday to Sunday

06: Sunday

07: Monday

08: Tuesday

09: Wednesday

0A: Thursday

0B: Friday

0C: Saturday

Data2 00 to 17: 00 to 23 Hours

Data3 00 to 3B: 00 to 59 Minutes

\* To read or delete the On Time list, set FFH for [Data2] and [Data3].

(Example 1: fd 01 f1 ff ff - Read the 1st On Time data.)

(Example 2: fd 01 e1 ff ff - Delete the 1st On Time data.)

(Example 3: fd 01 04 02 03 - Set the On Time to "Monday to Saturday, 02:03".)

\* This function is supported only when 1 (Year/Month/Day) and 2 (Hour/Minute/Second) are set.

**Acknowledgement**

[d][ ][Set ID][ ][OK/NG][Data1][Data2][Data3][x]

**27. On Timer Input (Command: f u)**

To select an external input for the current On Time setting and add a new schedule or change the existing schedule.

**Transmission**

[f][u][ ][Set ID][ ][Data1][Cr]

[f][u][ ][Set ID][ ][Data1][Data2][Cr]

Data (Add schedule)

20: Input (AV)

40: Component

60: RGB

70: DVI-D

90: HDMI (HDMI1)

C0: Display Port

91: HDMI2/SDI

B0: SuperSign

Data1 (Change schedule)

1. F1 to F7 (Read data)

F1: Select the 1st schedule input

F2: Select the 2nd schedule input

F3: Select the 3rd schedule input

F4: Select the 4th schedule input

F5: Select the 5th schedule input

F6: Select the 6th schedule input

F7: Select the 7th schedule input

Data2

20: Input (AV)

40: Component

60: RGB

70: DVI-D

90: HDMI (HDMI1)

C0: Display Port

91: HDMI2/SDI

B0: SuperSign

\* To read the schedule input, enter FFH for [Data2].

If no schedule is available for [Data1] when attempting to read or change the schedule data, the text NG will be displayed and the operation fails.

(Example 1: fu 01 60 - Move each schedule input down one row and save the 1st schedule input in RGB mode.)

(Example 2: fu 01 f1 ff - Read the 1st schedule input.)

(Example 3: fu 01 f3 20 - Change the 3rd data schedule input to the current On Time and AV input. If there is no third schedule, the text NG will be displayed and the operation fails.)

\* This function is supported only when 1 (Year/ Month/Day), 2 (Hour/Minute/Second), On Time (Repeat Mode/Time) are set.

\*\* It may not be supported depending on the model.

**Acknowledgement**

[u][ ][Set ID][ ][OK/NG][Data][x]

[u][ ][Set ID][ ][OK/NG][Data1][Data2][x]

**28. Sleep Time (Command: f f)**

To set the Sleep Time.

**Transmission**

[f][f][ ][Set ID][ ][Data][Cr]

Data 00: Off (Sleep Timer off)

01: 10 min.

02: 20 min.

03: 30 min.

04: 60 min.

05: 90 min.

06: 120 min.

07: 180 min.

08: 240 min.

**Acknowledgement**

[f][ ][Set ID][ ][OK/NG][Data][x]

**29. Power On Delay (Command: f h)**

To set the schedule delay when the power is turned on. (Unit: Second)

**Transmission**

[f][h][ ][Set ID][ ][Data][Cr]

Data 00 to 64: min. 0 to max. 100 (sec.)

**Acknowledgement**

[h][ ][Set ID][ ][OK/NG][Data][x]

**30. Automatic Standby (Command: m n)**

To set the Automatic Standby function.

**Transmission**

[m][n][ ][Set ID][ ][Data][Cr]

Data 00: Off (No off after 4 hours)

01: 4 Hours (Off after 4 hours)

**Acknowledgement**

[n][ ][Set ID][ ][OK/NG][Data][x]

**31. Auto Off (Command: f g)**

To set the Auto Off function.

Transmission

[f][g][ ][Set ID][ ][Data][Cr]

Data 00: Off (No off after 15 minutes)  
01: 15 min.(Off after 15 minutes)

Acknowledgement

[g][ ][Set ID][ ][OK/NG][Data][x]

**32. Language (Command: f i)**

To set the language for OSD.

Transmission

[f][i][ ][Set ID][ ][Data][Cr]

Data 00: Czech  
01: Danish  
02: German  
03: English  
04: Spanish (EU)  
05: Greek  
06: French  
07: Italian  
08: Dutch  
09: Norwegian  
0A: Portuguese  
0B: Portuguese (BR)  
0C: Russian  
0D: Finnish  
0E: Swedish  
0F: Korean  
10: Chinese (Mandarin)  
11: Japanese  
12: Yue Chinese (Cantonese)

Acknowledgement

[i][ ][Set ID][ ][OK/NG][Data][x]

**33. Power Indicator (Standby Light) (Command: f o)**

To set the Power Indicator (Standby Light) function.

Transmission

[f][o][ ][Set ID][ ][Data][Cr]

Data 00: Off  
01: On

\*\* It may not be supported depending on the model.

Acknowledgement

[o][ ][Set ID][ ][OK/NG][Data][x]

**34. Power Indicator (Power Light) (Command: f p)**

To set the Power Indicator (Power Light) function.

Transmission

[f][p][ ][Set ID][ ][Data][Cr]

Data 00: Off  
01: On

\*\* It may not be supported depending on the model.

Acknowledgement

[p][ ][Set ID][ ][OK/NG][Data][x]

**35. ISM mode (Command: j p)**

To select ISM method for avoiding having a fixed image remain on screen.

Transmission

[j][p][ ][Set ID][ ][Data][Cr]

Data 01: Inversion  
02: Orbiter  
04: White Wash  
08. Normal

Acknowledgement

[p][ ][Set ID][ ][OK/NG][Data][x]

**36. Fail Over Select (Command: m i)**

To set the Fail Over function.

Transmission

[m][i][ ][Set ID][ ][Data][Cr]

Data 00: Off  
01: Auto  
02: Manual

Acknowledgement

[i][ ][Set ID][ ][OK/NG][Data][x]



**37. Fail Over Input Select (Command: m j)**

To select the input source for auto switch.

\* This command is only available when the fail over (auto) mode is set to Custom.

**Transmission**

```
[m][j][ ][Set ID][ ][Data1][ ][Data2][ ][Data3][Cr]
[ ][Data4][ ][Data5][Cr]
```

Data 1 to 5 (Priority 1 to 5)

60: RGB

70: DVI-D

90: HDMI(HDMI1)

C0: Display Port

91: HDMI2/SDI

\* The number of data items differs depending on the model.

**Acknowledgement**

```
[j][ ][SetID][ ][OK/NG][Data1][Data2][Data3][Data4]
[ ][Data5][x]
```

**38. Reset (Command: f k)**

To execute the Picture, Screen, Audio and Factory reset function.

(Screen Reset can only be performed in RGB input mode.)

**Transmission**

```
[f][k][ ][Set ID][ ][Data][Cr]
```

Data 00: Picture Reset

01: Screen Reset

02: Factory Reset

03: Audio Reset

**Acknowledgement**

```
[k][ ][Set ID][ ][OK/NG][Data][x]
```

**39. Tile Mode (Command: d d)**

To set a Tile Mode and Tile Column/ Row values.

**Transmission**

```
[d][d][ ][Set ID][ ][Data][Cr]
```

Data 00 to FF: 1st byte - Tile Row

2nd byte - Tile Column

\*00, 01, 10, 11 means Tile Mode Off

\*\* It may not be supported depending on the model.

**Acknowledgement**

```
[d][ ][Set ID][ ][OK/NG][Data][x]
```

**40. Tile Mode Check (Command: d z)**

To check Tile Mode status.

**Transmission**

```
[d][z][ ][Set ID][ ][Data][Cr]
```

Data FF: Check Tile Mode status.

\*\* It may not be supported depending on the model.

**Acknowledgement**

```
[z][ ][Set ID][ ][OK/NG][Data1][Data2][Data3][x]
```

Data1 00: Tile Mode Off

01: Tile Mode On

Data2 00 to 0F: Tile Row

Data3 00 to 0F: Tile Column

**41. Tile ID (Command: d i)**

To set Tile ID.

**Transmission**

```
[d][i][ ][Set ID][ ][Data][Cr]
```

Data 01 to E1: Tile ID 01 to 225\*\*

FF: Check Tile ID

\*\* Data could not be set over (Tile Column) x (Tile Row).

\*\* It may not be supported depending on the model.

**Acknowledgement**

```
[i][ ][Set ID][ ][OK/NG][Data][x]
```

\*NG will be return if data is over (Tile Column) x (Tile Row), except 0xFF.

**42. Tile H Position (Command: d e)**

To adjust the Tile Horizontal position.

\* This function is available only when the Natural option of the Tile Mode is set to Off while the Tile Mode set to On.

**Transmission**

```
[d][e][ ][Set ID][ ][Data][Cr]
```

Data 00 to 32: -50 (Left) to 0 (Right)

\*Left/Right values depend on Tile H size.

\*\* It may not be supported depending on the model.

**Acknowledgement**

```
[e][ ][Set ID][ ][OK/NG][Data][x]
```

**43. Tile V Position (Command: d f)**

To adjust the Tile Vertical position.

\* This function is available only when the Natural option of the Tile Mode is set to Off while the Tile Mode set to On.

Transmission

[d][f][ ][Set ID][ ][Data][Cr]

Data 0 to 32: 0 (Bottom) to 50 (Top)

\* Bottom/Top values depend on Tile Vertical size.

\*\* It may not be supported depending on the model.

Acknowledgement

[f][ ][Set ID][ ][OK/NG][Data][x]

**44. Tile H Size (Command: d g)**

To adjust the Tile Horizontal Size.

\*Set Tile H Position to 0x32 before setting Tile H Size.

\* This function is available only when the Natural option of the Tile Mode is set to Off while the Tile Mode set to On.

Transmission

[d][g][ ][Set ID][ ][Data][Cr]

Data 00 to 32: 0 to 50

\*\* It may not be supported depending on the model.

Acknowledgement

[g][ ][Set ID][ ][OK/NG][Data][x]

**45. Tile V Size (Command: d h)**

To adjust the Tile Vertical size.

\*Set Tile V Position to 0x00 before setting Tile V Size.

\* This function is available only when the Natural option of the Tile Mode is set to Off while the Tile Mode set to On.

Transmission

[d][h][ ][Set ID][ ][Data][Cr]

Data 00 to 32: 0 to 50

\*\* It may not be supported depending on the model.

Acknowledgement

[h][ ][Set ID][ ][OK/NG][Data][x]

**46. Natural Mode (In Tile Mode) (Command : d j)**

To display the image naturally, the part of the image that would normally be displayed in the gap between the monitors is omitted.

Transmission

[d][j][ ][Set ID][ ][Data][Cr]

Data 00: Off

01: On

Acknowledgement

[j][ ][Set ID][ ][OK/NG][Data][x]

**47. DPM Select (Command: f j)**

To set the DPM (Display Power Management) function.

Transmission

[f][j][ ][Set ID][ ][Data][Cr]

Data 00: Off

01: On

\* Data settings may vary depending on your model as below.

Data 00: Off

01: 5 sec.

02: 10 sec.

03: 15 sec.

04: 1 min.

05: 3 min.

06: 5 min.

07: 10 min.

Acknowledgement

[j][ ][Set ID][ ][OK/NG][Data][x]

**48. FAN Control (Command : d o)**

To set the Fan mode.

Transmission

[d][o][ ][Set ID][ ][Data][Cr]

Data 00: Auto

01: On

02: Manual

03: Off

\*\* It may not be supported depending on the model.

Acknowledgement

[o][ ][Set ID][ ][OK/NG][Data][x]

**49. FAN Fault Check (Command: d w)**

To check the fan errors.

Transmission

[d][w][ ][Set ID][ ][Data][Cr]

Data FF: Read the status

Acknowledgement

[w][ ][Set ID][ ][OK/NG][Data][x]

Data 00: Fan fault  
01: Fan OK  
02: Model without a Fan

**50. Temperature Value (Command: d n)**

To check the inside temperature value.

Transmission

[d][n][ ][Set ID][ ][Data][Cr]

Data FF: Check the status

Acknowledgement

[n][ ][Set ID][ ][OK/NG][Data][x]

[n][ ][Set ID][ ][OK/NG][Data1][Data2][Data3][x]

\* Temperature is displayed in hexadecimal.

**51. Remote Controller Lock/ Key Lock (Command: k m)**

When the remote control and front keys are locked in standby mode, the power cannot be turned on using the remote control or front power button.

Transmission

[k][m][ ][Set ID][ ][Data][Cr]

Data 00: Off (Lock Off)  
01: On (Lock On)

\* Display will not be turned on by power on key of remote controller and front panel control keys, if key is locked on in standby mode.

Acknowledgement

[m][ ][Set ID][ ][OK/NG][Data][x]

\*\* It may not be supported depending on the model.

**52. Key (Command: m c)**

To send a key code of the IR remote control.

Transmission

[m][c][ ][Set ID][ ][Data][Cr]

Data IR\_KEY\_CODE

Acknowledgement

[c][ ][Set ID][ ][OK/NG][Data][x]

For a key code, see the IR Code.

\* Some key codes are not supported depending on the model.

**53. OSD Select (Command: k l)**

To select OSD(On Screen Display) on/off.

Transmission

[k][l][ ][Set ID][ ][Data][Cr]

Data 00: Off  
01: On

Acknowledgement

[l][ ][Set ID][ ][OK/NG][Data][x]

**54. Elapsed time return (Command: d l)**

To check the panel used time.

Transmission

[d][l][ ][Set ID][ ][Data][Cr]

Data FF: Read the status

Acknowledgement

[l][ ][Set ID][ ][OK/NG][Data][x]

\* Returned data means used hours in hexadecimal.

**55. Serial No.Check (Command: f y)**

To check the Serial Numbers.

Transmission

[f][y][ ][Set ID][ ][Data][Cr]

Data FF: Check the product Serial Number

Acknowledgement

[y][ ][Set ID][ ][OK/NG][Data][x]

\* Data is ASCII code.

**58. White Balance Green Gain (Command: j n)**

To set the White Balance Green Gain.

Transmission

[j][n][ ][Set ID][ ][Data][Cr]

Data 00 to FE: Green Gain 0 to 254

Acknowledgement

[n][ ][Set ID][ ][OK/NG][Data][x]

**56. S/W Version (Command: f z)**

To check the Software Version.

Transmission

[f][z][ ][Set ID][ ][Data][Cr]

Data FF: Check the Software version

Acknowledgement

[z][ ][Set ID][ ][OK/NG][Data][x]

**59. White Balance Blue Gain (Command: j o)**

To set the White Balance Blue Gain.

Transmission

[j][o][ ][Set ID][ ][Data][Cr]

Data 00 to FE: Blue Gain 0 to 254

Acknowledgement

[o][ ][Set ID][ ][OK/NG][Data][x]

**57. White Balance Red Gain (Command: j m)**

To set the White Balance Red Gain.

Transmission

[j][m][ ][Set ID][ ][Data][Cr]

Data 00 to FE: Red Gain 0 to 254

Acknowledgement

[m][ ][Set ID][ ][OK/NG][Data][x]

**60. Backlight (Command: m g)**

To adjust the screen backlight.

Transmission

[m][g][ ][Set ID][ ][Data][Cr]

Data 00 to 64: Backlight 0 to 100

Acknowledgement

[g][ ][Set ID][ ][OK/NG][Data][x]

\*\* It may not be supported depending on the model.

**61. PC Power Control (Command: d t)**

To control the PC power if the PC and the monitor are synchronized.

**Transmission**

[d][t][ ][Set ID][ ][Data][Cr]

**Data**

00: Synchronized (When the monitor is off, the PC is also turned off.)

01: Not synchronized (The monitor is off but the PC is on.)

02: Maintain the power-on state of the PC. (When you turn on the monitor while the Media Player is turned off, the Media Player is turned on.)

\*\* It may not be supported depending on the model.

**Acknowledgement**

[t][ ][Set ID][ ][OK][Data][x]

**62. PC Power (Command: d s)**

Control the PC power.

**Transmission**

[d][s][ ][Set ID][ ][Data][Cr]

Data 00: PC is turned off.

01: PC is turned on.

\*\* It may not be supported depending on the model.

**Acknowledgement**

[s][ ][Set ID][ ][OK][Data][x]

**63. Easy Brightness Control Mode (Command: s m)**

Selects ON/OFF of Easy Brightness Control Mode.

**Transmission**

[s][m][ ][Set ID][ ][Data][Cr]

Data 00: Easy Brightness Control OFF

01: Easy Brightness Control ON

\* It does not work if the current time is not set up.

\*\* It may not be supported, depending on the model.

**Acknowledgement**

[m][ ][Set ID][ ][OK/NG][Data][x]

**64. Easy Brightness Control Schedule (Command: s s)**

Sets the Easy Brightness Control Schedule.

**Transmission**

[s][s][ ][Set ID][ ][Data1][ ][Data2][ ][Data3][Cr]

**Data1**

1. F1 - F6 (Data Reading Functions)

F1: Reads the data of the 1st Easy Brightness Control

F2: Reads the data of the 2nd Easy Brightness Control

F3: Reads the data of the 3rd Easy Brightness Control

F4: Reads the data of the 4th Easy Brightness Control

F5: Reads the data of the 5th Easy Brightness Control

F6: Reads the data of the 6th Easy Brightness Control

2. E1-E6 (Deletes One Index), E0 (Delete All Indexes)

E0: Deletes all Easy Brightness Controls

E1: Deletes the 1st Easy Brightness Control

E2: Deletes the 2nd Easy Brightness Control

E3: Deletes the 3rd Easy Brightness Control

E4: Deletes the 4th Easy Brightness Control

E5: Deletes the 5th Easy Brightness Control

E6: Deletes the 6th Easy Brightness Control

3. 00-17: 00 - 23:00

Data2 00-3B: 00 - 59 minutes

Data3 00-64: backlight 0 - 100

\* To read or delete the configured Easy Brightness Control list, set [Data2][Data3] to FF.

(ex1: ss 01 f1 ff ff - Reads the 1st index data from the Easy Brightness Control.

ex2: ss 01 e1 ff ff - Deletes the 1st index data from the Easy Brightness Control.

ex3: ss 01 07 1E 46 - Adds a schedule to the backlight 70 at 07:30.)

**Acknowledgement**

[s][ ][Set ID][ ][OK/NG][Data1][Data2][Data3][x]

\*\* It may not be supported, depending on the model.

**65. Status check (Command: s v)**

Check various statuses.

**Transmission**

[s][v][ ][Set ID][ ][Data][ ][FF][Cr]

Data 05: Check the normal operation of No.1 and No.2 luminance sensors.

06: luminance sensor being used:

07: Check the normal operation of top, bottom, or main temperature sensors.

**Acknowledgement**

[v][ ][Set ID][ ][OK/NG][Data][Data1][x]

When the Data is 05

Data100: All normal

01: BLU sensor 1 normal, BLU sensor 2 fail

02: BLU sensor 1 fail, BLU sensor 2 normal

03: All fail

When the Data is 06

Data100: No.1 luminance sensor is being used

01: No.2 luminance sensor is being used

When the Data is 07

Data100: All temperature sensors fail

01: Top normal, Bottom fail, Main fail

02: Top fail, Bottom normal, Main fail

03: Top normal, Bottom normal, Main fail

04: Top fail, Bottom fail, Main normal

05: Top normal, Bottom fail, Main fail

06: Top fail, Bottom normal, Main fail

07: All temperature sensors normal

When the Data is 08

**Acknowledgement**

[v][ ][SetID][ ][OK/NG][Data][Data1][Data2][Data3][x]

Data1: Temperature of the top sensor area when the set is powered off.

Data2: Temperature of the bottom sensor area when the set is powered off.

Data3: Temperature of the main sensor area when the set is powered off.

When the Data is 09

**Acknowledgement**

[v][ ][SetID][ ][OK/NG][Data][Data1][Data2][x]

Data1 00-ff: Upper 2-byte of Fan Speed

Data2 00-ff: Lower 2-byte of Fan Speed

Fan Speed: Hex 0-20D0, Decimal 0-8400

\*\* It may not be supported, depending on the model.

**66. BLU Maintenance (Command: m t)**

Select ON/OFF of BLU Maintenance.

**Transmission**

[m][t][ ][Set ID][ ][Data][Cr]

Data 00: BLU Maintenance OFF

01: BLU Maintenance ON

\*\* It may not be supported, depending on the model.

**Acknowledgement**

[t][ ][Set ID][ ][OK/NG][Data][x]

**67. Screen mute (Command: k d)**

Turns the screen on or off.

**Transmission**

[k][d][ ][Set ID][ ][Data][Cr]

Data 00: Turns the screen on.

01: Turns the screen off.

**Acknowledgement**

[d][ ][Set ID][ ][OK/NG][Data][x]



ENERGY STAR is a set of power-saving guidelines issued by the U.S. Environmental Protection Agency(EPA).



As an ENERGY STAR Partner LGE U. S. A.,Inc. has determined that this product meets the ENERGY STAR guidelines for energy efficiency.

Make sure to read the Safety Precautions before using the product.  
Keep the Owner's Manual (CD) in an accessible place for future reference.  
The model and serial number of the SET is located on the back and one side of the SET. Record it below should you ever need service.

MODEL \_\_\_\_\_

SERIAL \_\_\_\_\_

To obtain the source code under GPL, LGPL, MPL and other open source licenses, that is contained in this product, please visit <http://opensource.lge.com>.

In addition to the source code, all referred license terms, warranty disclaimers and copyright notices are available for download. LG Electronics will also provide open source code to you on CD-ROM for a charge covering the cost of performing such distribution (such as the cost of media, shipping, and handling) upon email request to [opensource@lge.com](mailto:opensource@lge.com). This offer is valid for three (3) years from the date on which you purchased the product.

**WARNING** -This is a class A product. In a domestic environment this product may cause radio interference in which case the user may be required to take adequate measures.

Temporary noise is normal when powering ON or OFF this device.