



LG

Life's Good

OWNER'S MANUAL

LED TV*

*LG LED TVs are LCD TVs with LED backlighting.

Please read this manual carefully before operating your set and retain it for future reference.

LW75**

LW76**

LY75**

LY76**

LY96**

www.lg.com

TABLE OF CONTENTS

3 LICENSES

3 OPEN SOURCE SOFTWARE NOTICE

4 SAFETY INSTRUCTIONS

- 4 - Viewing 3D Imaging (Only 3D models)

6 INSTALLATION PROCEDURE

7 ASSEMBLING AND PREPARING

- 7 Unpacking
 11 Separate purchase
 12 Parts and Button
 13 - Using the Joystick button
 14 Lifting and Moving the TV
 15 Setting up the TV
 15 - Attaching the Stand
 18 Mounting on a table
 21 Mounting on a wall
 23 Tidying cables

24 MAKING CONNECTIONS

- 24 Antenna Connection
 25 Adapter Connection
 25 Satellite Dish Connection
 25 LED Clock Connection
 26 HDMI Connection
 27 MHL Connection
 27 Speaker Output Setup
 28 Network Setup
 28 - Wired network Connection
 29 Audio Connection
 29 - Digital Optical Audio Connection
 29 CI module Connection
 30 Headphone Connection
 30 USB Connection
 31 Euro Scart Connection

32 REMOTE CONTROL

35 MAINTENANCE

- 35 Cleaning your TV
 35 - Screen, Frame, Cabinet and Stand
 35 - Power Cord

36 TROUBLESHOOTING

37 SPECIFICATIONS

46 IR CODES

47 EXTERNAL CONTROL DEVICE SETUP

- 47 RS-232C Setup
 47 Type of Connector:
 D-Sub 9-Pin Male
 48 RS-232C Configurations
 49 Communication Parameters
 49 Command Reference List
 50 Transmission / Receiving Protocol



WARNING

- If you ignore the warning message, you may be seriously injured or there is a possibility of accident or death.



CAUTION

- If you ignore the caution message, you may be slightly injured or the product may be damaged.



NOTE

- The note helps you understand and use the product safely. Please read the note carefully before using the product.

LICENCES

Supported licenses may differ by model. For more information about licenses, visit www.lg.com.



Manufactured under license from Dolby Laboratories. Dolby and the double-D symbol are trademarks of Dolby Laboratories.



The terms HDMI and HDMI High-Definition Multimedia Interface, and the HDMI logo are trademarks or registered trademarks of HDMI Licensing LLC in the United States and other countries.



ABOUT DIVX VIDEO: DivX[®] is a digital video format created by DivX, LLC, a subsidiary of Rovi Corporation. This is an official DivX Certified[®] device that has passed rigorous testing to verify that it plays DivX video. Visit divx.com for more information and software tools to convert your files into DivX videos.

ABOUT DIVX VIDEO-ON-DEMAND: This DivX Certified[®] device must be registered in order to play purchased DivX Video-on-Demand (VOD) movies. To obtain your registration code, locate the DivX VOD section in your device setup menu. Go to vod.divx.com for more information on how to complete your registration.

"DivX Certified[®] to play DivX[®] video up to HD 1080p, including premium content."

"DivX[®], DivX Certified[®] and associated logos are trademarks of Rovi Corporation or its subsidiaries and are used under license."

"Covered by one or more of the following U.S. patents :
7,295,673; 7,460,668; 7,515,710; 7,519,274"



For DTS patents, see <http://patents.dts.com>. Manufactured under license from DTS Licensing Limited. DTS, the Symbol, & DTS and the Symbol together are registered trademarks, and DTS 2.0+Digital Out is a trademark of DTS, Inc. © DTS, Inc. All Rights Reserved.

OPEN SOURCE SOFTWARE NOTICE

To obtain the source code under GPL, LGPL, MPL and other open source licenses, that is contained in this product, please visit <http://opensource.lge.com>.

In addition to the source code, all referred license terms, warranty disclaimers and copyright notices are available for download.

LG Electronics will also provide open source code to you on CD-ROM for a charge covering the cost of performing such distribution (such as the cost of media, shipping and handling) upon email request to opensource@lge.com. This offer is valid for three (3) years from the date on which you purchased the product.

SAFETY INSTRUCTIONS



Please read these safety precautions carefully before using the product.

Viewing 3D Imaging (Only 3D models)



WARNING

Viewing Environment

- Viewing Time
 - When watching 3D contents, take 5 - 15 minute breaks every hour. Viewing 3D contents for a long period of time may cause headache, dizziness, fatigue or eye strain.

Those that have a photosensitive seizure or chronic illness

- Some users may experience a seizure or other abnormal symptoms when they are exposed to a flashing light or particular pattern from 3D contents.
- Do not watch 3D videos if you feel nausea, are pregnant and/ or have a chronic illness such as epilepsy, cardiac disorder, or blood pressure disease, etc.
- 3D Contents are not recommended to those who suffer from stereo blindness or stereo anomaly. Double images or discomfort in viewing may be experienced.
- If you have strabismus (cross-eyed), amblyopia (weak eyesight) or astigmatism, you may have trouble sensing depth and easily feel fatigue due to double images. It is advised to take frequent breaks than the average adult.
- If your eyesight varies between your right and left eye, revise your eyesight prior to watching 3D contents.

Symptoms which require discontinuation or refraining from watching 3D contents

- Do not watch 3D contents when you feel fatigue from lack of sleep, overwork or drinking.
- When these symptoms are experienced, stop using/watching 3D contents and get enough rest until the symptom subsides.
 - Consult your doctor when the symptoms persist. Symptoms may include headache, eyeball pain, dizziness, nausea, palpitation, blurriness, discomfort, double image, visual inconvenience or fatigue.

**CAUTION****Viewing Environment**

- Viewing Distance
 - Maintain a distance of at least twice the screen diagonal length when watching 3D contents. If you feel discomfort in viewing 3D contents, move further away from the TV.

Viewing Age

- Infants/Children
 - Usage/ Viewing 3D contents for children under the age of 6 are prohibited.
 - Children under the age of 10 may overreact and become overly excited because their vision is in development (for example: trying to touch the screen or trying to jump into it. Special monitoring and extra attention is required for children watching 3D contents.
 - Children have greater binocular disparity of 3D presentations than adults because the distance between the eyes is shorter than that of adults. Therefore they will perceive more stereoscopic depth compared to adults for the same 3D image.
- Teenagers
 - Teenagers under the age of 19 may react with sensitivity due to stimulation from light in 3D contents. Advise them to refrain from watching 3D contents for a long time when they are tired.
- Elderly
 - The elderly may perceive less 3D effect compared to the young. Do not sit closer to the TV than the recommended distance.

Cautions when using the 3D glasses

- Make sure to use LG 3D glasses. Otherwise, you may not be able to view 3D videos properly.
- Do not use 3D glasses instead of your normal glasses, sunglasses or protective goggles.
- Using modified 3D glasses may cause eye strain or image distortion.
- Do not keep your 3D glasses in extremely high or low temperatures. It will cause deformation.
- The 3D glasses are fragile and are easily scratched. Always use a soft, clean piece of cloth when wiping the lenses. Do not scratch the lenses of the 3D glasses with sharp objects or clean/wipe them with chemicals.

**NOTE**

- Image shown may differ from your TV.
- Your TV's OSD (On Screen Display) may differ slightly from that shown in this manual.
- The available menus and options may differ from the input source or product model that you are using.
- New features may be added to this TV in the future.
- The TV can be placed in standby mode in order to reduce the power consumption. And the TV should be turned off if it will not be watched for some time, as this will reduce energy consumption.
- The energy consumed during use can be significantly reduced if the level of brightness of the picture is reduced, and this will reduce the overall running cost.

INSTALLATION PROCEDURE

- 1 Open the package and make sure all the accessories are included.
 - 2 Attach the stand to the TV set. (Depending on model)
 - 3 Connect an external device to the TV set.
 - 4 Make sure the network connection is available.
You can use the TV network functions only when the network connection is made.
- * If the TV is turned on for the first time after it was shipped from the factory, initialization of the TV may take a few minutes.

ASSEMBLING AND PREPARING

Unpacking

Check your product box for the following items. If there are any missing accessories, contact the local dealer where you purchased your product. The illustrations in this manual may differ from the actual product and item.



CAUTION

- Do not use any unapproved items to ensure the safety and product life span.
- Any damage or injuries caused by using unapproved items are not covered by the warranty.
- Some models have a thin film attached on to the screen and this must not be removed.



NOTE

- The items supplied with your product may vary depending on the model.
- Product specifications or contents of this manual may be changed without prior notice due to upgrade of product functions.
- For an optimal connection, HDMI cables and USB devices should have bezels less than 10 mm thick and 18 mm width. Use an extension cable that supports USB 2.0 if the USB cable or USB memory stick does not fit into your TV's USB port.

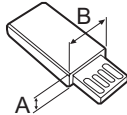
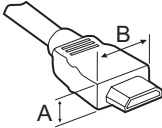

*A \leq 10 mm

*B \leq 18 mm

- Use a certified cable with the HDMI logo attached.
- If you do not use a certified HDMI cable, the screen may not display or a connection error may occur. (Recommended HDMI Cable Types)
 - High-Speed HDMI[®]/™ Cable
 - High-Speed HDMI[®]/™ Cable with Ethernet

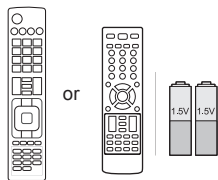

Remote control, Batteries (AAA)
 (Only LW75**, LY75**, LY76**, LY96**)
 (See p. 32, 33, 34)

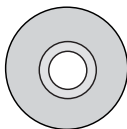

Owner's manual



Cable Holder
 (Depending on model)
 (See p. 23)



Wall Mount Spacers
 2EA
 (Only 42LW75**, 42LW76**, 42LY75**, 42LY76**)
 (See p. 22)

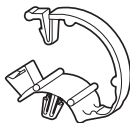

Cable Managements
 2EA
 (Only LY750*, LY760*, LY96**)
 (See p. 23)

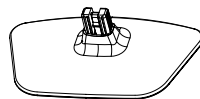

Stand Base
 (Only 22LW75**)
 (See p. 15)

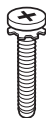

Stand Screws
 4EA, M4 x L20
 (Only 32LY750*, 42/47/55LY751*, 32LY760*, 42/47/55LY761*)
 6EA, M4 x L20
 (Only 32/39LY751*, 32/39LY761*)
 (See p. 15, 16, 17)



Stand Screws
 4EA, M4 x L14
 (Only 39/42/47/55LY750*, 42/47/55LY751*, 39/42/47/55LY760*, 42/47/55LY761*, 42/47/55LY96**)
 (See p. 15, 17)



Stand Screws
 4EA, M4 x L12
 (Only 60LY96**)
 (See p. 15)



Power cord

or

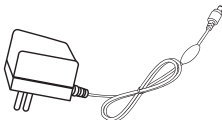

AC-DC Adapter
 (See p. 25)

or

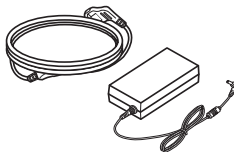

Power Cord/ AC-DC Adapter
 (See p. 25)

(Depending on model)

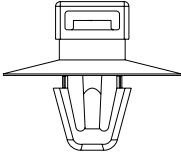

Cable Holders
4EA
(Only 22/28LW75**)

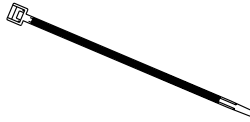

Cable Managements
2EA
(Only 22/28LW75**)

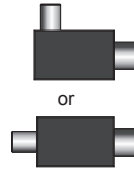

Isolator
(Depending on model)
(See p. 10)

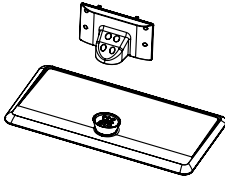

Stand Base/Stand Body
(Only LY751*, LY761*)
(See p. 16, 17)

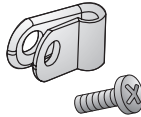

Power Cord Holder/Screw
1EA
(Only 39/42/47/55LY751*,
39/42/47/55LY761*)
(See p. 23)



**Torx Plus Star-Head
Screws**
2EA
(Only LY751*, LY761*)
(See p. 16, 17)

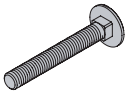

Screws for Stand Fixing
2EA
(Depending on model)
(See p. 20)



Washers for Stand Fixing
2EA
(Depending on model)
(See p. 20)

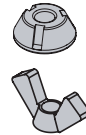

Nuts for Stand Fixing
2EA
(Depending on model)
(See p. 20)



Rubbers
2EA
(Only LY751*, LY761*)
(See p. 18)

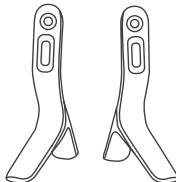

Stand Bases
(Only LY750*, LY760*,
LY96**)
(See p. 15)

**NOTE**

- Antenna Isolator Installation Guide
 - Use this to install TV in a place where there is a voltage difference between TV Set and GND of antenna signal.
 - » If there is a voltage difference between TV Set and GND of antenna signal, the antenna contact might be heated and excessive heat might cause an accident.
 - You can improve the safety when watching TV by efficiently removing power voltage from TV antenna. It is recommended to mount the isolator to the wall. If it cannot be mounted to the wall, mount it on the TV. Avoid disconnecting the antenna Isolator after installation.
 - Before starting, be sure that the TV antenna is connected.

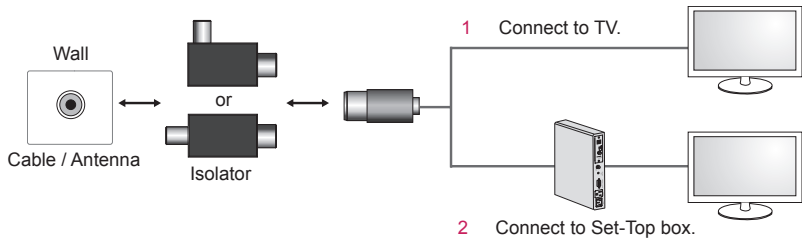

Connect one end of the isolator to cable/antenna jack and the other to TV set or set-top box.

"Equipment connected to the protective earthing of the building installation through the mains connection or through other equipment with a connection to protective earthing - and to a cable distribution system using coaxial cable, may in some circumstances create a fire hazard. Connection to a cable distribution system has therefore to be provided through a device providing electrical isolation below a certain frequency range (galvanic isolator, see EN 60728-11)"

When applying the RF Isolator, a slight loss of signal sensitivity can occur.

Separate purchase

Separate purchase items can be changed or modified for quality improvement without any notification. Contact your dealer to buy these items. These devices only work with certain models.

LG Audio Device	AN-MR300 Magic Remote	AN-MR500 Magic Remote
LED Clock LEC-003	AG-F*** Cinema 3D Glasses	WCR-800 Wireless Charging Remote
WCP-800 Wireless Charging Pad		

Compatibility	LW75**	LW76**	LY75**	LY76**	LY96**
LG Audio Device	•	•	•	•	•
AN-MR300 Magic Remote	•		•		
AN-MR500 Magic Remote		•		•	•
LED Clock LEC-003	• (Except for 22/28LW75**)	•	•	•	
AG-F*** Cinema 3D Glasses					•
WCR-800 Wireless Charging Remote		•			
WCP-800 Wireless Charging Pad		•			

The model name or design may be changed depending on the upgrade of product functions, manufacturer's circumstances or policies.

Parts and Button

A type : 22/28LW75**

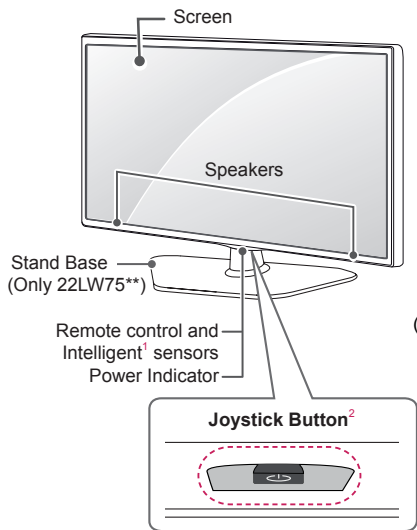

B type : 32/39/42/47LW75**, LW76**, LY750*, LY760*

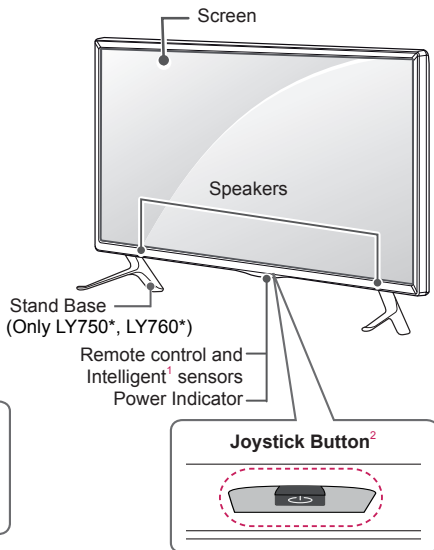

C type : LY751*, LY761*

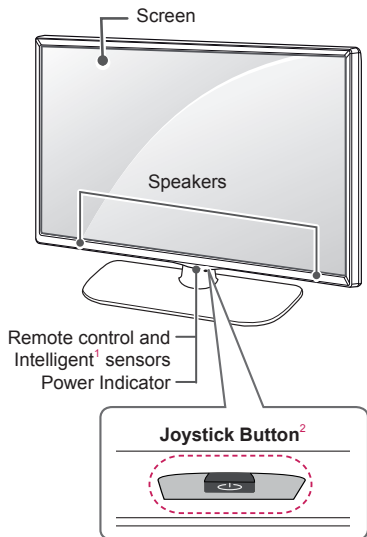

D type : LY96**

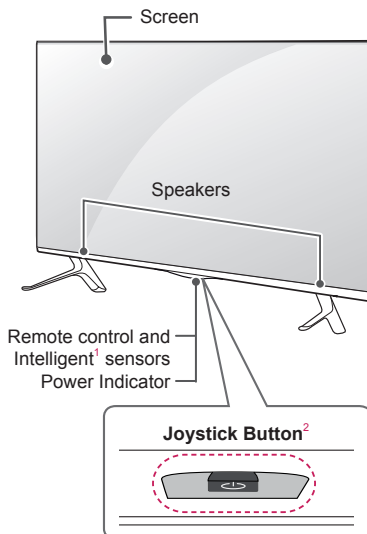

- 1 Intelligent sensor - Adjusts the image quality and brightness based on the surrounding environment.
- 2 Joystick Button - This button is located below the TV screen.



**NOTE**

- You can set the power indicator light to on or off by selecting **OPTION** or **General** in the main menus.

Using the Joystick button

You can simply operate the TV functions, pressing or moving the joystick button up, down, left or right.

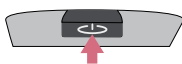
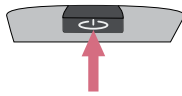
Basic Functions

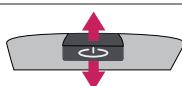
	Power On	When the TV is turned off, place your finger on the joystick button and press it once and release it.
	Power Off	When the TV is turned on, place your finger on the joystick button and press it once for a few seconds and release it.
	Volume Control	If you place your finger over the joystick button and move it left or right, you can adjust the volume level you want.
	Programmes Control	If you place your finger over the joystick button and move it up or down, you can scrolls through the saved programmes you want.

**NOTE**





- When your finger over the joystick button and push it to the up, down, left or right, be careful not to press the joystick button. If you press the joystick button first, you may not be able to adjust the volume level and saved programmes.

Adjusting the Menu

(Only LW76**, LY76**, LY96**)

When the TV is turned on, press the joystick button one time.

You can adjust the Menu items(, , ) moving the joystick button left or right.

		TV OFF	Turns the power off.
		CLOSE	Closes Clears on-screen displays and returns to TV viewing.
		INPUT	Changes the input source.

Lifting and Moving the TV

Please note the following advice to prevent the TV from being scratched or damaged and for safe transportation regardless of its type and size.



CAUTION

- Avoid touching the screen at all times, as this may result in damage to the screen.
- It is recommended to move the TV in the box or packing material that the TV originally came in.
- Before moving or lifting the TV, disconnect the power cord and all cables.
- When holding the TV, the screen should face away from you to avoid damage.

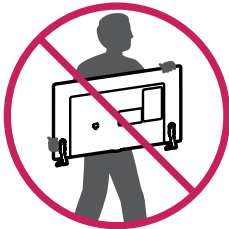

- Hold the top and bottom of the TV frame firmly. Make sure not to hold the transparent part, speaker, or speaker grill area.

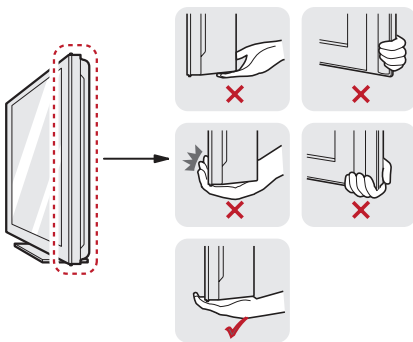

- When transporting a large TV, there should be at least 2 people.
- When transporting the TV by hand, hold the TV as shown in the following illustration.

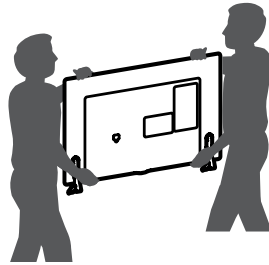

- When transporting the TV, do not expose the TV to jolts or excessive vibration.
- When transporting the TV, keep the TV upright, never turn the TV on its side or tilt towards the left or right.
- Do not apply excessive pressure to cause flexing /bending of frame chassis as it may damage screen.



CAUTION

- When handling the TV, be careful not to damage the protruding joystick button. (Image shown may differ from your TV.)



Setting up the TV

Image shown may differ from your TV.

Attaching the Stand

22LW75**

1

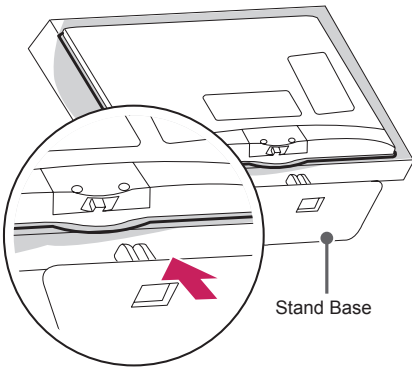

LY750*, LY760*, LY96**

1

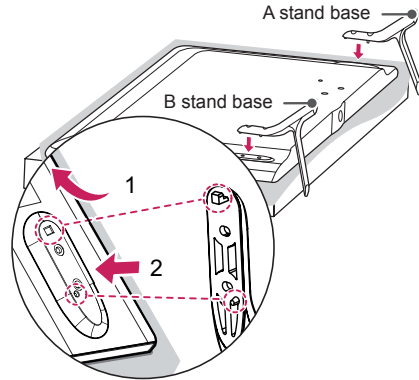

- 1 Attach the stand to the TV using the upper mounting hole on the back of the TV.
- 2 Attach the stand to the TV using the lower connection on the back of the TV.

2

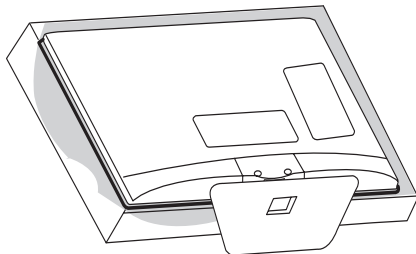

2

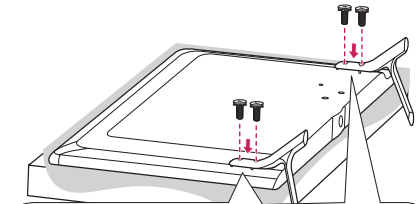

	 M4 x L12 (Only 60LY96**)
	 M4 x L14 (Only 39/42/47/55LY750*, 39/42/47/55LY760*, 42/47/55LY96**)
	 M4 x L20 (Only 32LY750*, 32LY760*)

4EA

32/39LY751*, 32/39LY761*

1

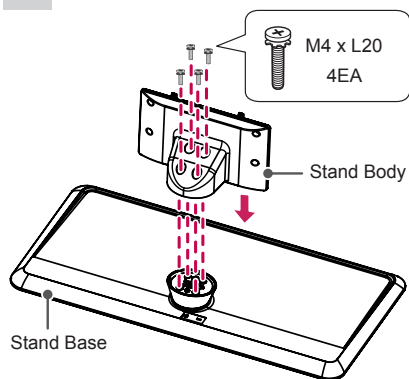

2

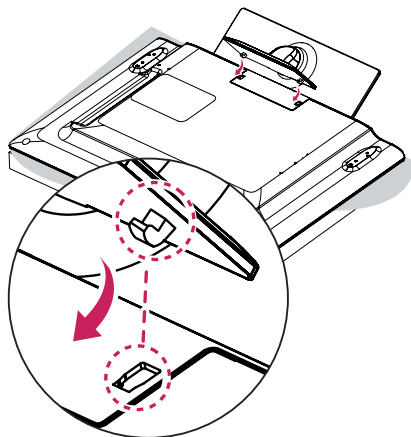

3

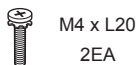

or

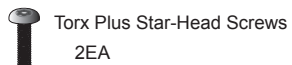

Tighten the two Torx head screws (supplied with TV) with a Torx Bit Driver (not supplied with TV).

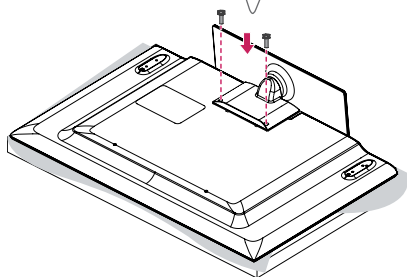
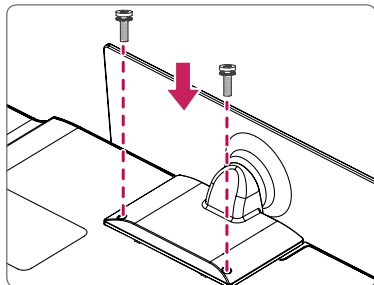

42/47/55LY751*, 42/47/55LY761*

1

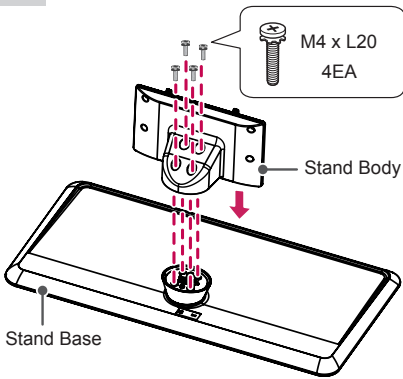

2

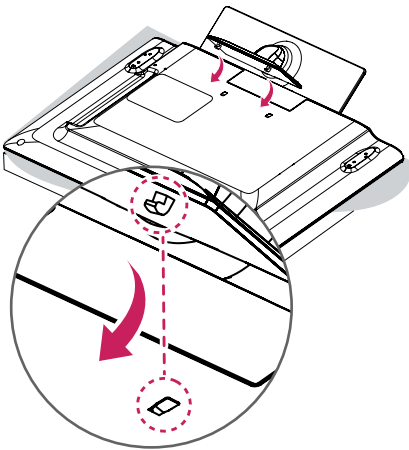

3

M4 x L14
4EA

or

M4 x L14
2EA

Torx Plus Star-Head Screws
2EA

Tighten the two of these four screws and the two Torx screws (supplied with TV) to secure the TV. Tighten the two Torx screws with a Torx Bit Driver (not supplied with TV).

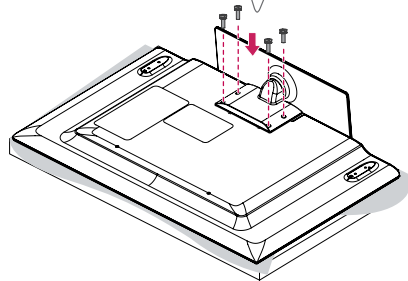
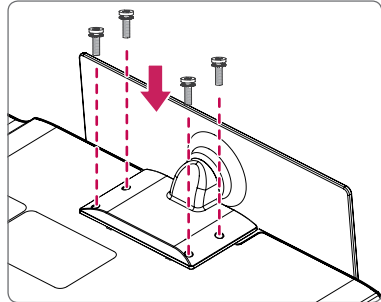

**CAUTION**

- When attaching the stand to the TV set, place the screen facing down on a cushioned table or flat surface to protect the screen from scratches.
- Make sure that the screws are fastened completely. (If they are not fastened securely enough, the TV may tilt forward after being installed.)
Do not use too much force and over tighten the screws; otherwise screw may be damaged and not tighten correctly.

**NOTE**

- Remove the stand before installing the TV on a wall mount by performing the stand attachment in reverse.
- The Rubber will protect the opening from accumulating dust and dirt. When installing the wall mounting bracket, use the Rubber. (Only LY751*, LY761*)

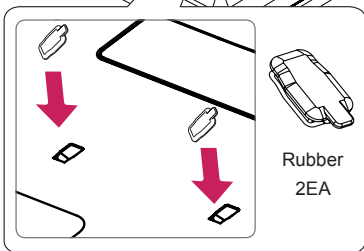
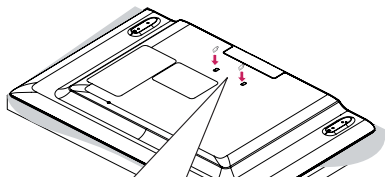
**Mounting on a table**

- 1 Lift and tilt the TV into its upright position on a table.
 - Leave a 10 cm (minimum) space from the wall for proper ventilation.

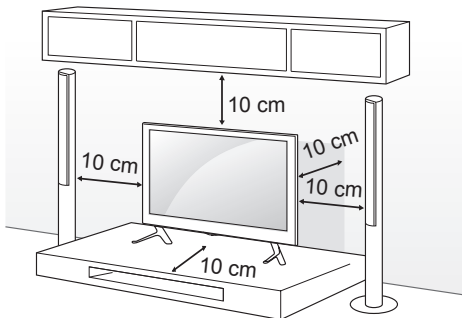

- 2 Connect the power cord to a wall outlet.

**CAUTION**

- Do not place the TV near or on sources of heat, as this may result in fire or other damage.

Using the Kensington security system

(This feature is not available for all models.)
 • Image shown may differ from your TV.

The Kensington security system connector is located at the rear of the TV. For more information of installation and using, refer to the manual provided with the Kensington security system or visit <http://www.kensington.com>.

Connect the Kensington security system cable between the TV and a table.

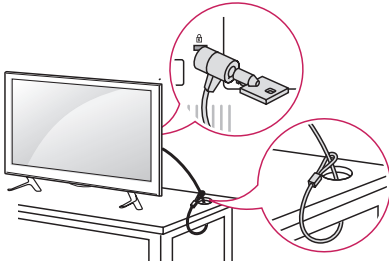

Adjusting the angle of the TV to suit view

(Only LY751*, LY761*)

Swivel 20 degrees to the left or right and adjust the angle of the TV to suit your view.

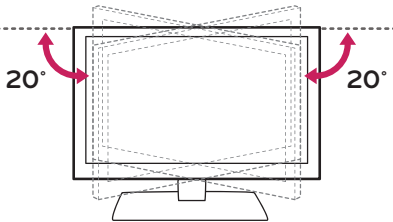

CAUTION

- When adjusting the angle of the product, watch out for your fingers.
 - » Personal injury may occur if hands or fingers are pinched. If the product is tilted too much, it may fall, causing damage or injury.

Attaching the TV to a desk

(Depending on model)

The TV should be attached to a desk so it cannot be pulled in a forward/backward direction, potentially causing injury or damaging the product.

A type)

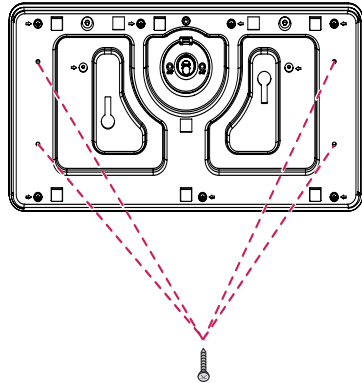

4-Screws
(Not supplied with TV)

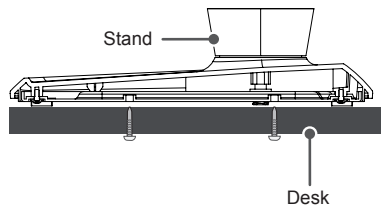

NOTE

- Screw : M5 x L (*L: Table depth + 8~10 mm)
 ex) Table depth: 15 mm, Screw: M5 x 25

B type)

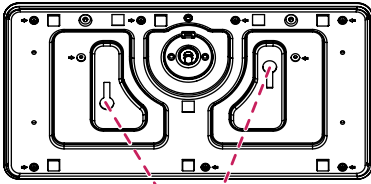

2-Screws for Stand Fixing,
2-Washers for Stand Fixing,
2-Nuts for Stand Fixing
(Supplied with TV)

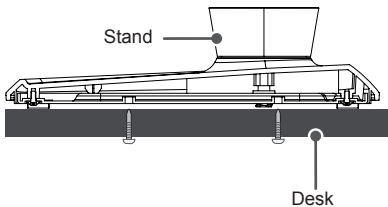

Securing the TV to a Wall

(This feature is not available for all models.)

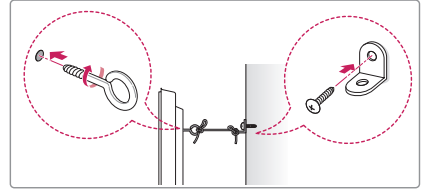
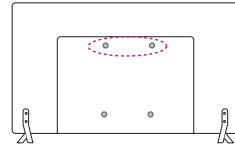

- 1 Insert and tighten the eye-bolts, or TV brackets and bolts on the back of the TV.
- If there are bolts inserted at the eye-bolts position, remove the bolts first.
- 2 Mount the wall brackets with the bolts to the wall.
Match the location of the wall bracket and the eye-bolts on the rear of the TV.
- 3 Connect the eye-bolts and wall brackets tightly with a sturdy rope.
Make sure to keep the rope horizontal with the flat surface.



CAUTION

- Make sure that children do not climb on or hang on the TV.



NOTE

- Use a platform or cabinet that is strong and large enough to support the TV securely.
- Brackets, bolts and ropes are not provided. You can obtain additional accessories from your local dealer.

Mounting on a wall

Attach an optional wall mount bracket at the rear of the TV carefully and install the wall mount bracket on a solid wall perpendicular to the floor. When you attach the TV to other building materials, please contact qualified personnel. LG recommends that wall mounting be performed by a qualified professional installer. We recommend the use of LG's wall mount bracket.

When you do not use LG's wall mount bracket, please use a wall mount bracket where the device is adequately secured to the wall with enough space to allow connectivity to external devices.

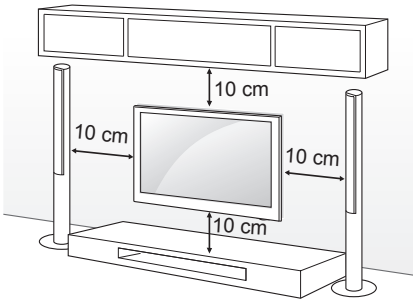

Make sure to use screws and wall mount bracket that meet the VESA standard. Standard dimensions for the wall mount kits are described in the following table.

Separate purchase (Wall Mounting Bracket)

Model	32/39LY76** 32/39LY75** 32/39LW75** 32LW76**	42/47/55LY76** 42/47/55LY75** 42/47LW75** 42LW76**
VESA (A x B)	200 x 200	400 x 400
Standard screw	M6	M6
Number of screws	4	4
Wall mount bracket	LSW240B MSW240	LSW440B MSW240
Model	22LW75**	28LW75**
VESA (A x B)	75 x 75	100 x 100
Standard screw	M4 X L10	M4 X L10
Number of screws	4	4
Wall mount bracket	LSW140B	LSW140B
Model	42/47/55/60LY96**	
VESA (A x B)	400 x 400	
Standard screw	M6	
Number of screws	4	
Wall mount bracket	LSW440B	

Wall mount bracket			
LSW140B	LSW240B	LSW440B	MSW240

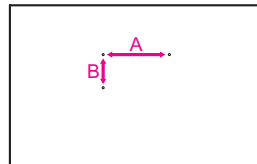

**CAUTION**

- Disconnect the power first, and then move or install the TV. Otherwise electric shock may occur.
- If you install the TV on a ceiling or slanted wall, it may fall and result in severe injury. Use an authorised LG wall mount and contact the local dealer or qualified personnel.
- Do not over tighten the screws as this may cause damage to the TV and void your warranty.
- Use the screws and wall mounts that meet the VESA standard. Any damages or injuries by misuse or using an improper accessory are not covered by the warranty.
- Screw length from outer surface of back cover should be under 8 mm. (Only 22/28LW75**)

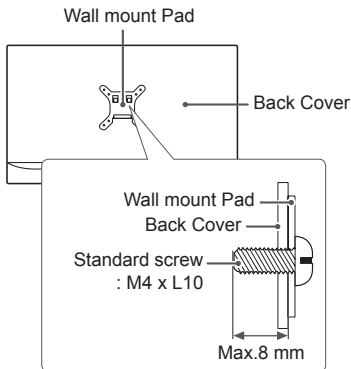
**NOTE**

- Use the screws that are listed on the VESA standard screw specifications.
- The wall mount kit includes an installation manual and necessary parts.
- The wall mount bracket is not provided. You can obtain additional accessories from your local dealer.
- The length of screws may differ depending on the wall mount. Make sure to use the proper length.
- For more information, refer to the manual supplied with the wall mount.
- When attaching a wall mounting bracket to the TV, insert the wall mount spacers into the TV wall mount holes to adjust the vertical angle of the TV. (Only 42LW75**, 42LW76**, 42LY75**, 42LY76**)

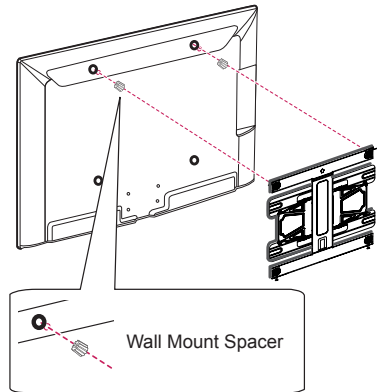

Tidying cables

Image shown may differ from your TV.

(Only 22LW75**)

- 1 Gather and bind the cables with the cable holder.

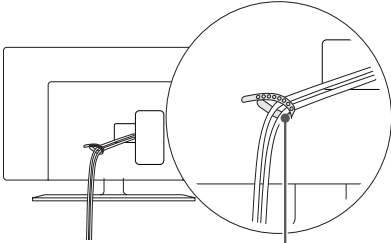

Cable Holder

(Only 28/32/39/42/47LW75**, LW76**)

- 1 Gather and bind the cables with the cable holder.

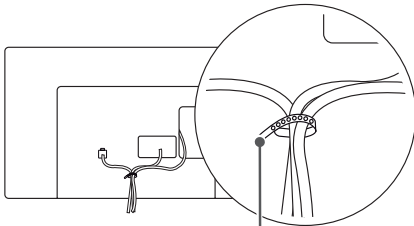

Cable Holder

(Only LY750*, LY760*, LY96**)

- 1 Gather and bind the cables with the cable holder.
- 2 Fix the Cable Management firmly to the TV.

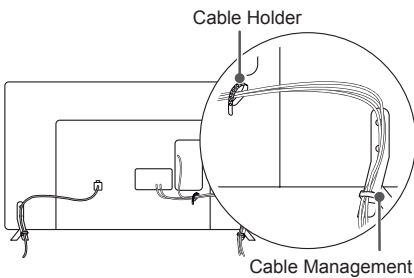

Cable Management

(Only 32LY751*, 32LY761*)

- 1 Gather and bind the cables with the cable holder.

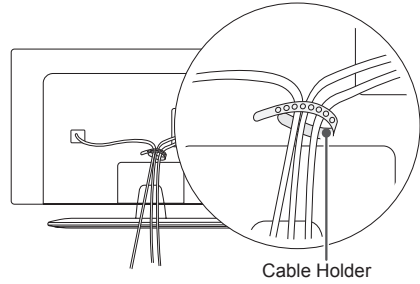

Cable Holder

(Only 39/42/47/55LY751*, 39/42/47/55LY761*)

- 1 Install the power cord holder and power cord. It will help prevent the power cable from being removed by accident.
- 2 Gather and bind the cables with the cable holder.

Power Cord Holder/Screw

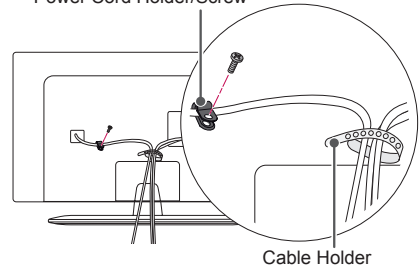

Cable Holder



CAUTION

- Do not move the TV by holding the cable holder, as the cable holder may break, and injuries and damage to the TV may occur.

MAKING CONNECTIONS

This section on **MAKING CONNECTIONS** mainly uses diagrams for the 42LY750* models.

Connect various external devices to the TV and switch input modes to select an external device. For more information on external device's connection, refer to the manual provided with each device.

Available external devices are: HD receivers, DVD players, VCRs, audio systems, USB storage devices, PC, gaming devices, and other external devices.

NOTE

- The external device connection may differ from the model.
- Connect external devices to the TV regardless of the order of the TV port.
- If you record a TV program on a DVD recorder or VCR, make sure to connect the TV signal input cable to the TV through a DVD recorder or VCR. For more information on recording, refer to the manual provided with the connected device.
- Refer to the external equipment's manual for operating instructions.
- If you connect a gaming device to the TV, use the cable supplied with the gaming device.
- In PC mode, there may be noise associated with the resolution, vertical pattern, contrast or brightness. If noise is present, change the PC output to another resolution, change the refresh rate to another rate or adjust the brightness and contrast on the PICTURE menu until the picture is clear.
- In PC mode, some resolution settings may not work properly depending on the graphics card.
- Only a USB storage device is recognizable.

Antenna Connection

Connect the TV to a wall antenna socket with an RF cable (75 Ω).

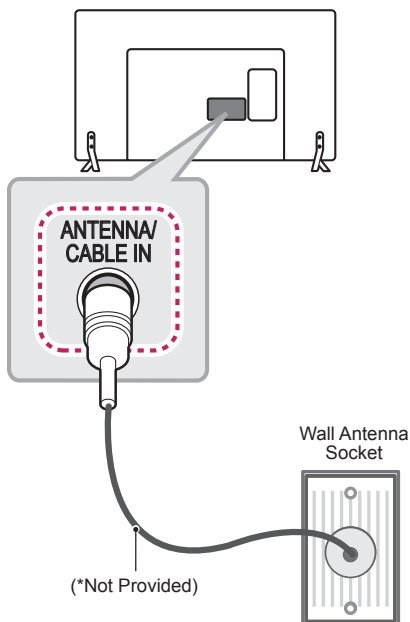

NOTE

- Use a signal splitter to use more than 2 TVs.
- If the image quality is poor, install a signal amplifier properly to improve the image quality.
- If the image quality is poor with an antenna connected, try to realign the antenna in the correct direction.
- An antenna cable and converter are not supplied.
- Supported DTV Audio: MPEG, Dolby Digital, Dolby Digital Plus, HE-AAC

Adapter Connection

(Only 22/28LW75**)

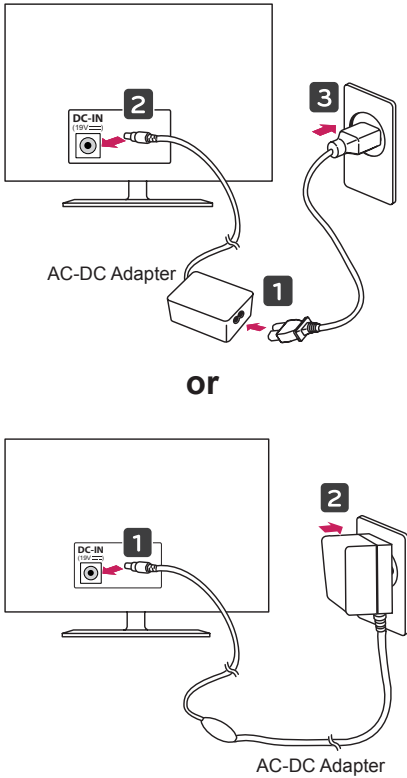

CAUTION

- Please be sure to connect the TV to the AC-DC power adapter before connecting the TV's power plug to a wall power outlet.

Satellite Dish Connection

(Only satellite models)

Connect the TV to a satellite dish to a satellite socket with a satellite RF cable (75 Ω).

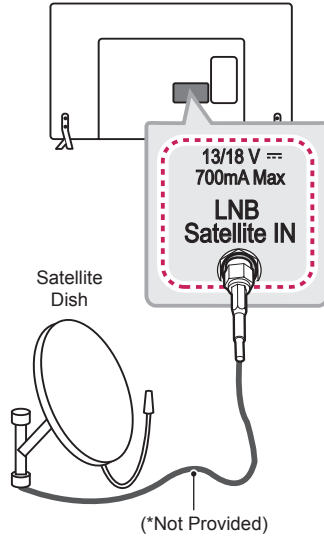

LED Clock Connection

(Only 32/39/42/47LW75**, LW76**, LY75**, LY76**)

This TV can be connected to a LED Clock via the **CLOCK** port.

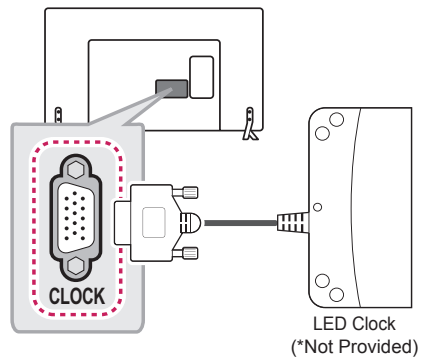

HDMI Connection

Transmits the digital video and audio signals from your PC to the TV. Connect the PC and the TV with the HDMI cable as shown. Choose any HDMI input port to connect. It does not matter which port you use.

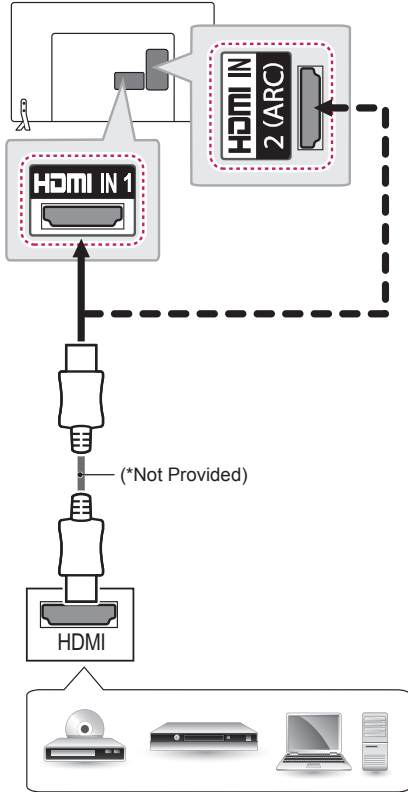

ARC (Audio Return Channel)

- An external audio device that supports SIMPLINK and ARC must be connected using **HDMI IN 1 (ARC)** or **HDMI IN 2 (ARC)** port.
- When connected with a high-speed HDMI cable, the external audio device that supports ARC outputs optical SPDIF without additional optical audio cable and supports the SIMPLINK function.



NOTE

- It is recommended to use the TV with the HDMI connection for the best image quality.
- Use the latest High Speed HDMI™ Cable with CEC (Customer Electronics Control) function.
- High Speed HDMI™ Cables are tested to carry an HD signal up to 1080p and higher.
- Supported HDMI Audio format :
Dolby Digital (32 KHz, 44.1 KHz, 48 KHz),
PCM (32 KHz, 44.1 KHz, 48 KHz, 96 KHz, 192 KHz),
DTS supported. (44.1 KHz, 48KHz - Only LW76**, LY76**, LY96**),
DTS not supported. (Only LW75**, LY75**)

MHL Connection

(Only LW76**, LY76**, LY96**)

Mobile High-definition Link (MHL) is an interface for transmitting digital audiovisual signals from mobile phones to television sets.

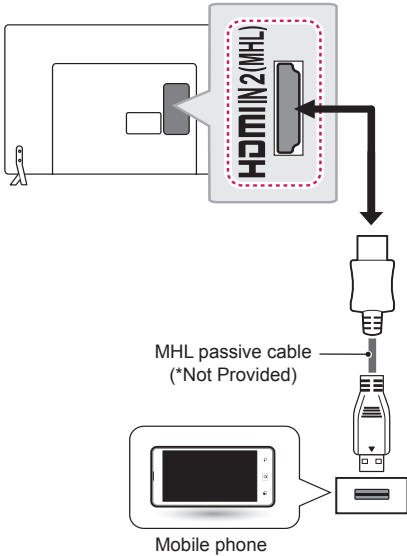

NOTE

- Connect the mobile phone to the **HDMI IN 2 (MHL)** or **HDMI IN 3 (MHL)** port to view the phone screen on the TV.
- The MHL passive cable is needed to connect the TV and a mobile phone.
- This only works for the MHL-enabled phone.
- Some applications can be operated by the remote control.
- Remove the MHL passive cable from the TV when:
 - » the MHL function is disabled
 - » your mobile device is fully charged in standby mode

Speaker Output Setup

Connect the external speaker to the **SPEAKER OUT** jack on the TV.

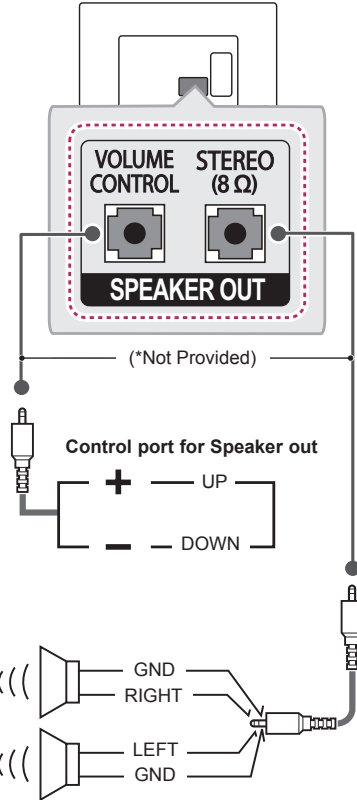

Method of Volume control port

* Cable Spec.

	<p>Each Up/ Down pin is pulled to 3.3V with CPU GPIO.</p> <p>CPU detects transition from 3.3V to GND level for volume control.</p>
--	--

Network Setup

Wired network Connection

This TV can be connected to a Pro:Centric server via the **LAN** port. After making the physical connection, the TV needs to be set up for network communication.

Connect the LAN port of the Modem or Router from Pro:Centric server to the **LAN** port on the TV.



CAUTION

- Do not connect a modular phone cable to the **LAN** port.
- Since there are various connection methods, please follow the specifications of your telecommunication carrier or internet service provider.

(Only 22/28LW75**)

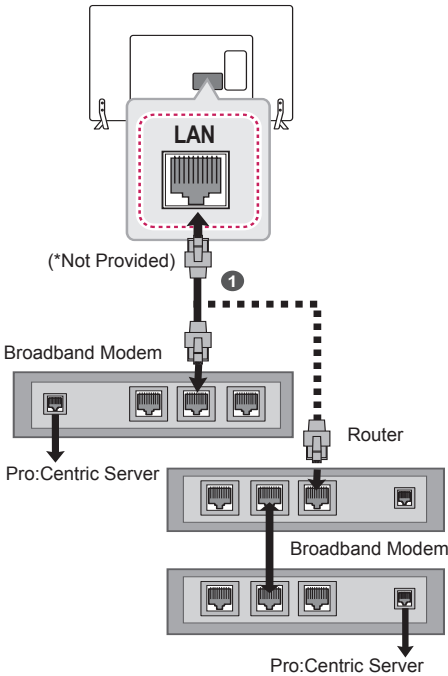

1

Connect the LAN port of the Modem or Router to the LAN port on the TV.

(Only 32/39/42/47LW75**, LW76**, LY75**, LY76**, LY96**)

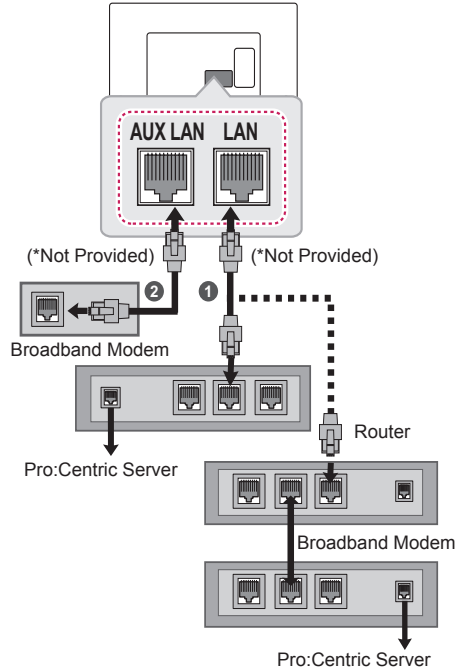

1

Connect the LAN port of the Modem or Router to the LAN port on the TV.

2

Connect the LAN port of the PC to the AUX LAN port on the TV.

Audio Connection

You may use an optional external audio system instead of the built-in speaker.

Digital Optical Audio Connection

Transmits a digital audio signal from the TV to an external device. Connect the external device and the TV with the optical audio cable as shown.

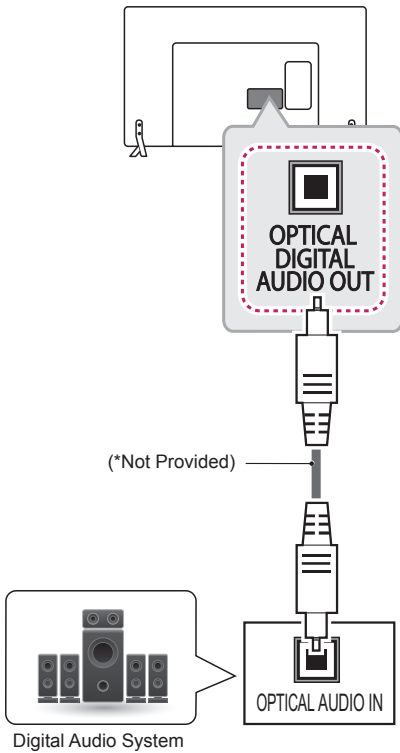

NOTE

- Do not look into the optical output port. Looking at the laser beam may damage your vision.
- Audio with ACP (Audio Copy Protection) function may block digital audio output.

CI module Connection

View the encrypted (pay) services in digital TV mode. This feature is not available in all countries.

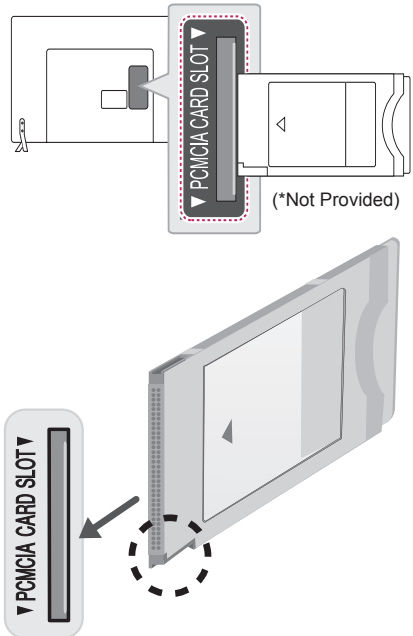

NOTE

- Check if the CI module is inserted into the PCMCIA card slot in the right direction. If the module is not inserted properly, this can cause damage to the TV and the PCMCIA card slot.

Headphone Connection

Transmits the headphone signal from the TV to an external device. Connect the external device and the TV with the headphone as shown.

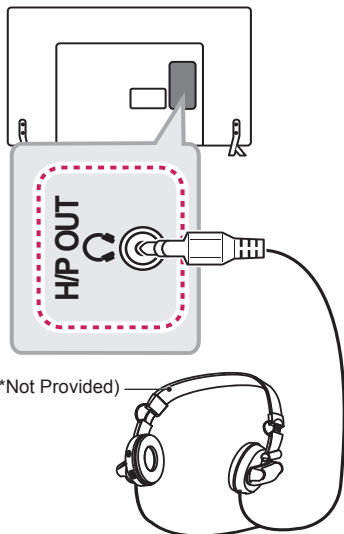

(*Not Provided)

NOTE

- AUDIO menu items are disabled when connecting a headphone.
- When changing **AV MODE** with a headphone connected, the change is applied to video but not to audio.
- Optical Digital Audio Out is not available when connecting a headphone.
- Headphone impedance: 16 Ω
- Max audio output of headphone:
 - » 9 mW to 15 mW (Only LW75**, LY75**)
 - » 0.627 mW to 1.334 mW (Only LW76**, LY76**, LY96**)
- Headphone jack size: 0.35 cm

USB Connection

Connect a USB storage device such as a USB flash memory, external hard drive or a USB memory card reader to the TV and access the SmartShare menu to use various multimedia files.

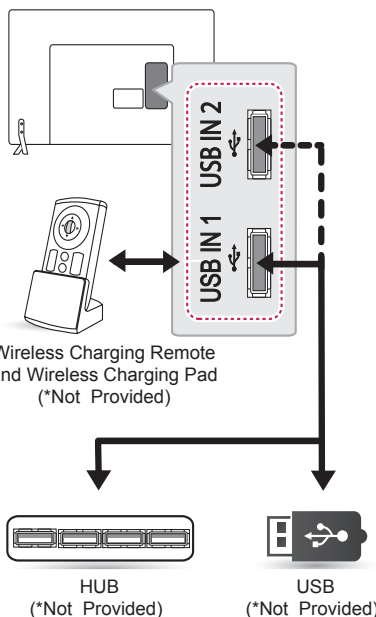

Wireless Charging Remote and Wireless Charging Pad
(*Not Provided)



HUB
(*Not Provided)



USB
(*Not Provided)

NOTE

- Some USB Hubs may not work. If a USB device connected using a USB Hub is not detected, connect it to the USB port on the TV directly.
- To charge the Wireless Charging Remote (WCR-800), please use **USB IN 1**. (Only LW76**)

Euro Scart Connection

Transmits the video and audio signals from an external device to the TV set. Connect the external device and the TV set with the Euro scart cable as shown.

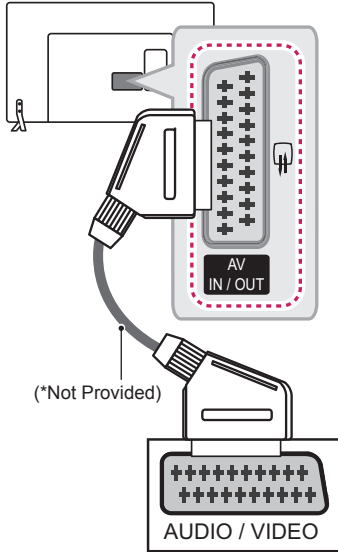

Output Type	AV (TV Out ¹)
Current input mode	
Digital TV	Digital TV
Analogue TV, AV	Analogue TV
HDMI	

¹ TV Out : Outputs Analogue TV or Digital TV signals.



NOTE

- Any Euro scart cable used must be signal shielded.
- When watching digital TV in 3D imaging mode, only 2D out signals can be output through the SCART cable. (Only 3D models)

REMOTE CONTROL

The descriptions in this manual are based on the buttons on the remote control. Please read this manual carefully and use the TV correctly. To replace batteries, open the battery cover, replace batteries (1.5 V AAA) matching the \oplus and \ominus ends to the label inside the compartment, and close the battery cover. To remove the batteries, perform the installation actions in reverse.

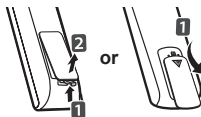

CAUTION

- Do not mix old and new batteries, as this may damage the remote control.

Make sure to point the remote control toward the remote control sensor on the TV.

(Only 22/28/32/42LW75**, LY75**)

	<p>(POWER) Turns the TV on or off.</p> <p>ENERGY SAVING Adjusts the brightness of the screen to reduce energy consumption.</p> <p>AV MODE Selects an AV mode. (Depending on model)</p> <p>INPUT Changes the input source.</p> <p>TV/RAD Selects Radio, TV and DTV programme.</p>
	<p>Number buttons Enters numbers.</p> <p>LIST Accesses the saved programme list.</p> <p>Q.VIEW Returns to the previously viewed programme.</p>
	<p>+ / - Adjusts the volume level.</p> <p>FAV Accesses your favourite programme list.</p> <p>RATIO Resizes an image.</p> <p>MUTE Mutes all sounds.</p> <p>^ P v Scrolls through the saved programmes.</p> <p>← PAGE → Moves to the previous or next screen.</p>
	<p>GUIDE Shows programme guide.</p> <p>PORTAL Displays and removes hotel interactive menu.</p> <p>INFO Views the information of the current programme and screen.</p> <p>Navigation buttons (up/down/left/right) Scrolls through menus or options.</p> <p>OK Selects menus or options and confirms your input.</p> <p>SETTINGS Accesses the main menu.</p> <p>(BACK) Returns to the previous level.</p> <p>EXIT Clears on-screen displays and return to TV viewing.</p>
	<p>Coloured buttons These access special functions in some menus. (: Red, : Green, : Yellow, : Blue)</p> <p>Teletext buttons These buttons are used for teletext.</p> <p>SUBTITLE Recalls your preferred subtitle in digital mode.</p> <p>Control buttons (, , , ,) Controls the Premium contents, SmartShare menu or the SIMPLINK compatible devices (USB or SIMPLINK).</p> <p>(SIMPLINK) Accesses the AV devices connected with the HDMI cable through HDMI-CEC. Opens the SIMPLINK menu.</p> <p>Q.MENU Accesses the Quick menu.</p> <p>AD By Pressing AD button, audio descriptions function will be enabled.</p> <p>ALARM Sets the alarm function. (Depending on model)</p>

(Only 39/47LW75**)

ENERGY SAVING Adjusts the brightness of the screen to reduce energy consumption.

(POWER) Turns the TV on or off.

TV/RAD Selects Radio, TV and DTV programme.

GUIDE Shows programme guide.

INFO Views the information of the current programme and screen.

SUBTITLE Recalls your preferred subtitle in digital mode.

Q.MENU Accesses the Quick menus.

INPUT Changes the input source.

Number buttons Enters numbers.

LIST Accesses the saved programme list.

Q.VIEW Returns to the previously viewed programme.

PORTAL Displays and removes hotel interactive menu.

SETTINGS Accesses the main menus.

Navigation buttons (up/down/left/right) Scrolls through menus or options.

OK Selects menus or options and confirms your input.

BACK Returns to the previous level.

EXIT Clears on-screen displays and return to TV viewing.

+ / - Adjusts the volume level.

FAV Accesses your favourite programme list.

RATIO Resizes an image.

MUTE Mutes all sounds.

+ P - Scrolls through the saved programmes.

PAGE Moves to the previous or next screen.

Coloured buttons These access special functions in some menus.
 (Red): Red, (Green): Green, (Yellow): Yellow, (Blue): Blue

Control buttons Controls the Premium contents, SmartShare menus or the SIMPLINK compatible devices (USB or SIMPLINK).

SIMPLINK Accesses the AV devices connected with the HDMI cable through HDMI-CEC. Opens the SIMPLINK menu.

Teletext buttons These buttons are used for teletext.

(Only LY76**, LY96**)

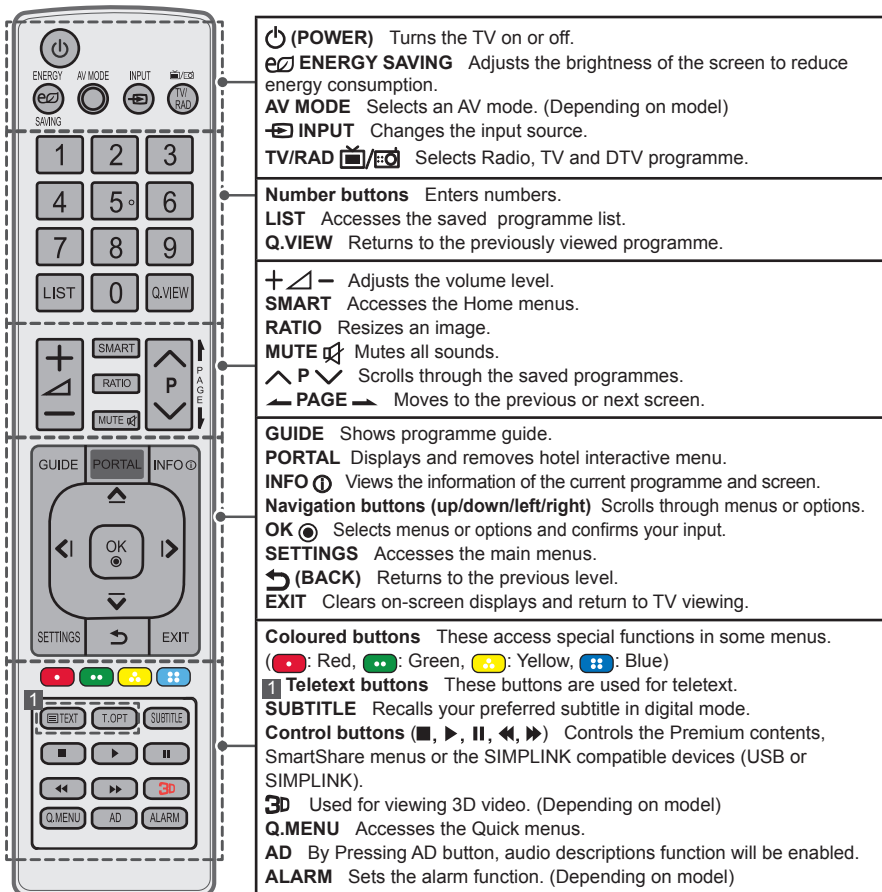

MAINTENANCE

Cleaning your TV

Clean your TV regularly to keep the best performance and to extend the product lifespan.



CAUTION

- Make sure to turn the power off and disconnect the power cord and all other cables first.
- When the TV is left unattended and unused for a long time, disconnect the power cord from the wall outlet to prevent possible damage from lightning or power surges.

Screen, Frame, Cabinet and Stand

- To remove dust or light dirt, wipe the surface with a dry, clean, and soft cloth.
- To remove major dirt, wipe the surface with a soft cloth dampened in clean water or a diluted mild detergent. Then wipe immediately with a dry cloth.



CAUTION

- Avoid touching the screen at all times, as this may result in damage to the screen.
- Do not push, rub, or hit the screen surface with your fingernail or a sharp object, as this may result in scratches and image distortions.
- Do not use any chemicals as this may damage the product.
- Do not spray liquid onto the surface. If water enters the TV, it may result in fire, electric shock, or malfunction.

Power Cord

Remove the accumulated dust or dirt on the power cord regularly.

TROUBLESHOOTING

The software version can be updated for improvement in performance. Customer needs to ensure the compatibility of customer's equipment with LGE software. If needed, please consult with LGE and upload revised software version according to the guidance provided by LGE.

Problem	Solution
Cannot control the TV with the remote control.	<ul style="list-style-type: none"> • Check the remote control sensor on the product and try again. • Check if there is any obstacle between the product and the remote control. • Check if the batteries are still working and properly installed (⊕ to ⊕, ⊖ to ⊖).
No image display and no sound is produced.	<ul style="list-style-type: none"> • Check if the product is turned on. • Check if the power cord is connected to a wall outlet. • Check if there is a problem in the wall outlet by connecting other products.
The TV turns off suddenly.	<ul style="list-style-type: none"> • Check the power control settings. The power supply may be interrupted. • Check if the Automatic Standby (Depending on model) / Sleep Timer / Time Power Off is activated in the TIME or Timers settings.
When connecting to the PC (HDMI), 'No signal' or 'Invalid Format' is displayed.	<ul style="list-style-type: none"> • Turn the TV off/on using the remote control. • Reconnect the HDMI cable. • Restart the PC with the TV on.

SPECIFICATIONS

Product specifications may be changed without prior notice due to upgrade of product functions.

MODELS		22LW75**	28LW75**	
		22LW750H-ZA	28LW750H-ZA	
Dimensions (W x H x D)	With stand (mm)	506 x 354 x 140.6	-	
	Without stand (mm)	506 x 311.7 x 55.8	638 x 389 x 56.8	
Weight	With stand (kg)	3.2	-	
	Without stand (kg)	3.0	4.3	
Power consumption		42 W	55 W	
Power requirement		19 V --- 2.0 A	19 V --- 2.7 A	
AC/DC Adapter		Manufacturer : Lien Chang Model : LCAP35 Manufacture : APD Model : DA-48F19	Manufacturer : Lien Chang Model : LCAP39 Manufacture : APD Model : DA-65G19	
		Input: AC 100-240 V~ 50/60 Hz Output: 19 V --- 2.53 A	Input: AC 100-240 V~ 50/60 Hz Output: 19 V --- 3.42 A	
MODELS		32LW75**	39LW75**	42LW75**
		32LW750H-ZA	39LW750H-ZB	42LW750H-ZA
Dimensions (W x H x D)	With stand (mm)	-	-	-
	Without stand (mm)	732 x 437 x 55.5	885 x 524 x 55.5	961 x 567 x 55.5
Weight	With stand (kg)	-	-	-
	Without stand (kg)	6.0	8	9.2
Power requirement		AC 100-240 V~ 50 / 60 Hz		
Power consumption		75 W	100 W	110 W
MODELS		47LW75**	32LW76**	42LW76**
		47LW750H-ZB	32LW760H-ZA	42LW760H-ZA
Dimensions (W x H x D)	With stand (mm)	-	-	-
	Without stand (mm)	1073 x 629 x 55.8	732 x 437 x 55.5	961 x 567 x 55.5
Weight	With stand (kg)	-	-	-
	Without stand (kg)	12.3	6.0	9.2
Power requirement		AC 100-240 V~ 50 / 60 Hz		
Power consumption		120 W	75 W	110 W

MODELS		32LY750*	39LY750*	42LY750*
		32LY750H-ZA	39LY750H-ZA	42LY750H-ZA
Dimensions (W x H x D)	With stand (mm)	732 x 481 x 207	885 x 567 x 218	961 x 612 x 218
	Without stand (mm)	732 x 437 x 55.5	885 x 524 x 55.5	961 x 567 x 55.5
Weight	With stand (kg)	6.2	8.3	9.5
	Without stand (kg)	6.0	8	9.2
Power requirement		AC 100-240 V~ 50 / 60 Hz		
Power consumption		75 W	100 W	110 W
MODELS		47LY750*	55LY750*	32LY751*
		47LY750H-ZA	55LY750H-ZA	32LY751H-ZA
Dimensions (W x H x D)	With stand (mm)	1073 x 676 x 247	1243 x 772 x 247	732 x 482 x 282
	Without stand (mm)	1073 x 629 x 55.8	1243 x 725 x 56.8	732 x 437 x 55.5
Weight	With stand (kg)	12.7	17.7	8.9
	Without stand (kg)	12.3	17.3	6.0
Power requirement		AC 100-240 V~ 50 / 60 Hz		
Power consumption		120 W	140 W	75 W
MODELS		39LY751*	42LY751*	47LY751*
		39LY751H-ZA	42LY751H-ZA	47LY751H-ZA
Dimensions (W x H x D)	With stand (mm)	885 x 572 x 282	961 x 617 x 325	1073 x 680 x 325
	Without stand (mm)	885 x 524 x 55.5	961 x 567 x 55.5	1073 x 629 x 55.8
Weight	With stand (kg)	10.9	12.6	15.7
	Without stand (kg)	8	9.2	12.3
Power requirement		AC 100-240 V~ 50 / 60 Hz		
Power consumption		100 W	110 W	120 W
MODELS		55LY751*	32LY760*	39LY760*
		55LY751H-ZA	32LY760H-ZA	39LY760H-ZA
Dimensions (W x H x D)	With stand (mm)	1243 x 771 x 325	732 x 481 x 207	885 x 567 x 218
	Without stand (mm)	1243 x 725 x 56.8	732 x 437 x 55.5	885 x 524 x 55.5
Weight	With stand (kg)	20.7	6.2	8.3
	Without stand (kg)	17.3	6.0	8
Power requirement		AC 100-240 V~ 50 / 60 Hz		
Power consumption		140 W	75 W	100 W

MODELS		42LY760*	47LY760*	55LY760*
		42LY760H-ZA	47LY760H-ZA	55LY760H-ZA
Dimensions (W x H x D)	With stand (mm)	961 x 612 x 218	1073 x 676 x 247	1243 x 772 x 247
	Without stand (mm)	961 x 567 x 55.5	1073 x 629 x 55.8	1243 x 725 x 56.8
Weight	With stand (kg)	9.5	12.7	17.7
	Without stand (kg)	9.2	12.3	17.3
Power requirement		AC 100-240 V~ 50 / 60 Hz		
Power consumption		110 W	120 W	140 W
MODELS		32LY761*	39LY761*	42LY761*
		32LY761H-ZA	39LY761H-ZA	42LY761H-ZA
Dimensions (W x H x D)	With stand (mm)	732 x 482 x 282	885 x 572 x 282	961 x 617 x 325
	Without stand (mm)	732 x 437 x 55.5	885 x 524 x 55.5	961 x 567 x 55.5
Weight	With stand (kg)	8.9	10.9	12.6
	Without stand (kg)	6.0	8	9.2
Power requirement		AC 100-240 V~ 50 / 60 Hz		
Power consumption		75 W	100 W	110 W
MODELS		47LY761*	55LY761*	42LY96**
		47LY761H-ZA	55LY761H-ZA	42LY960H-ZA
Dimensions (W x H x D)	With stand (mm)	1073 x 680 x 325	1243 x 771 x 325	949 x 611 x 218
	Without stand (mm)	1073 x 629 x 55.8	1243 x 725 x 56.8	949 x 560 x 55.1
Weight	With stand (kg)	15.7	20.7	10.3
	Without stand (kg)	12.3	17.3	10
Power requirement		AC 100-240 V~ 50 / 60 Hz		
Power consumption		120 W	140 W	95 W
MODELS		47LY96**	55LY96**	60LY96**
		47LY960H-ZA	55LY960H-ZA	60LY960H-ZA
Dimensions (W x H x D)	With stand (mm)	1061 x 677 x 247	1231 x 772 x 247	1338.4 x 837 x 273.5
	Without stand (mm)	1061 x 623 x 55.1	1231 x 718 x 55.1	1338.4 x 778.8 x 58.1
Weight	With stand (kg)	13.2	18.9	21.8
	Without stand (kg)	12.8	18.5	21.3
Power requirement		AC 100-240 V~ 50 / 60 Hz		
Power consumption		100 W	130 W	140 W

CI Module Size (W x H x D)		100.0 mm x 55.0 mm x 5.0 mm
Environment condition	Operating Temperature	0 °C to 40 °C
	Operating Humidity	Less than 80 %
	Storage Temperature	-20 °C to 60 °C
	Storage Humidity	Less than 85 %

	Satellite Digital TV ¹	Digital TV	Analogue TV
Television system	DVB-T/T2 DVB-C DVB-S/S2	DVB-T DVB-C	PAL/SECAM B/G/D/K, PAL I/I', SECAM L/L'
Programme coverage	VHF, UHF C-Band, Ku-Band	VHF, UHF	VHF : E2 to E12, UHF : E21 to E69, CATV: S1 to S20, HYPER: S21 to S47
Maximum number of storable programmes	DVB-S/S2 : 6,000 DVB-T/T2/C & Analogue TV : 1,500		
External antenna impedance	75 Ω		

- ¹ Satellite and DVB-T2 support models.

(Only LW75**, LY75**)

Wireless LAN module(TWFM-B006D) specification	
Standard	IEEE802.11a/b/g/n
Frequency Range	2400 to 2483.5 MHz 5150 to 5250 MHz 5725 to 5850 MHz (for Non EU)
Output Power (Max.)	802.11a: 11 dBm 802.11b: 14 dBm 802.11g: 10.5 dBm 802.11n - 2.4GHz: 11 dBm 802.11n - 5GHz: 12.5 dBm
<ul style="list-style-type: none"> Because band channel used by the country could be different, the user can not change or adjust the operating frequency and this product is set for the regional frequency table. This device should be installed and operated with minimum distance 20 cm between the device and your body. And this phrase is for the general statement for consideration of user environment. 	
	

(Only LW76**, LY76**, LY96**)

Wireless module(LGSBW41) Specifications			
Wireless LAN module		Bluetooth module	
Standard	IEEE 802.11a/b/g/n	Standard	Bluetooth Version 3.0
Frequency range	2400 to 2483.5 MHz 5150 to 5250 MHz 5725 to 5850 MHz(for Non EU)	Frequency range	2400 to 2483.5 MHz
Output power(Max.)	802.11a: 13 dBm 802.11b: 15 dBm 802.11g: 14 dBm 802.11n - 2.4GHz: 16 dBm 802.11n - 5GHz: 16 dBm	Output power(Max.)	10 dBm or Lower
<ul style="list-style-type: none"> Because band channel used by the country could be different, the user can not change or adjust the operating frequency and this product is set for the regional frequency table. This device should be installed and operated with minimum distance 20 cm between the device and your body. And this phrase is for the general statement for consideration of user environment. 			
			

HDMI-DTV Supported Mode

Resolution	Horizontal Frequency (kHz)	Vertical Frequency (Hz)
720 x 480	31.469 31.5	59.94 60
720 x 576	31.25 15.625	50 50
1280 x 720	37.500 44.96 45	50 59.94 60
1920 x 1080	33.72 33.75 28.125 26.97 27 28.125 33.716 33.75 56.250 67.43 67.5	59.94 60 50.00 23.97 24 25 29.976 30.00 50 59.94 60

HDMI-PC Supported Mode

- PC audio not supported.

Resolution	Horizontal Frequency (kHz)	Vertical Frequency (Hz)
640 x 350	31.468	70.09
720 x 400	31.469	70.08
640 x 480	31.469	59.94
800 x 600	37.879	60.31
1024 x 768	48.363	60.00
1152 x 864	54.348	60.053
1280 x 1024	63.981	60.020
1360 x 768	47.712	60.015
1920 x 1080	67.5	60.00

3D supported mode (Only 3D models)

- Video, which is input as below media contents is switched into the 3D screen automatically. The method for 3D digital broadcast may differ depending on the signal environment. If video is not switched automatically into 3D, manually convert the settings to view 3D images. For models supporting Miracast / Intel® WiDi, you can set the 3D mode.









3D supported mode automatically					
Input	Signal	Horizontal Frequency (kHz)	Vertical Frequency (Hz)	Playable 3D video format	
HDMI	480p	31.469 / 31.5	59.94 / 60	Top & Bottom, Side by Side(Half), Side by Side(Full)	
		62.938 / 63		Frame Packing, Line Alternative	
	576p	31.25	50	Top & Bottom, Side by Side(Half), Side by Side(Full)	
		62.5		Frame Packing, Line Alternative	
	720p	37.50	50	Top & Bottom, Side by Side(Half), Side by Side(Full)	
		44.96 / 45	59.94 / 60		
		75	50	Frame Packing, Line Alternative	
	89.91 / 90	59.94 / 60	50	Top & Bottom, Side by Side(Half), Side by Side(Full)	
		28.125			50
		33.72 / 33.75			59.94 / 60
	1080i	56.25	50	Frame Packing, Field Alternative	
		67.432 / 67.5	59.94 / 60		
		26.97 / 27	23.97 / 24		Top & Bottom, Side by Side(Half), Side by Side(Full)
	28.125	25			
	33.716 / 33.75	29.976 / 30			
	1080p	43.94 / 54	23.97 / 24	Frame packing, Line Alternative	
		56.25	25		
		67.432 / 67.5	29.976 / 30		
		56.25	50		
		67.432 / 67.5	59.94 / 60		Top & Bottom, Side by Side(Half)
	Signal			Playable 3D video format	
DTV	Frame Compatible			Side by Side(Half), Top & Bottom	

3D supported mode manually				
Input	Signal			Playable 3D video format
	Resolution	Horizontal Frequency (kHz)	Vertical Frequency (Hz)	
DTV	HD / SD	-	-	2D to 3D, Side by Side(Half), Top & Bottom
ATV (CVBS/ SCART)	SD	-	-	
HDMI-PC	1024 x 768p	48.36	60	
	1360 x 768p	47.71		
	1920 x 1080p	67.5		2D to 3D, Side by Side(Half), Top & Bottom, Checker Board, Single Frame Sequential, Row Interleaving, Column Interleaving
	Others	-	-	2D to 3D, Side by Side(Half), Top & Bottom
HDMI-DTV	480P	31.5	60	2D to 3D, Side by Side(Half), Top & Bottom, Checker Board, Frame Sequential, Row Interleaving, Column Interleaving
	576P	31.25	50	
	720p	37.5	50	
		45	60	
	1080i	28.125	50	2D to 3D, Side by Sied(Half), Top & Bottom
		33.75	60	
	1080p	27	24	2D to 3D, Side by Side(Half), Top & Bottom, Checker Board, Row Interleaving, Column Interleaving
		28.12	25	
		33.75	30	
		56.25	50	2D to 3D, Side by Side(Half), Top & Bottom, Checker Board, Frame Sequential, Row Interleaving, Column Interleaving
67.5	60			
USB (Movie)	Under 704 x 480	-	-	2D to 3D
	Over 704 x 480 under 1080p interlaced	-	-	2D to 3D, Side by Side(Half), Top & Bottom
	Over 704 x 480 under 1080p progressive	-	50 / 60	2D to 3D, Side by Side(Half), Top & Bottom, Checker Board, Row Interleaving, Column Interleaving, Frame Sequential
	Over 704 x 480 under 1080p progressive	-	Others	2D to 3D, Side by Side(Half), Top & Bottom, Checker Board, Row Interleaving, Column Interleaving

3D supported mode manually				
Input	Signal			Playable 3D video format
	Resolution	Horizontal Frequency (kHz)	Vertical Frequency (Hz)	
USB(Photo)	Under 320 x 240	-	-	2D to 3D
	Over 320 x 240	-	-	2D to 3D, Side by Side(Half), Top & Bottom
Miracast/ Intel® WiDi	1024 x 768p	-	30 / 60	2D to 3D, Side by Side(Half), Top & Bottom
	1280 x 768p	-	30 / 60	
	1920 x 1080p	-	30 / 60	
	Others	-	-	2D to 3D

IR CODES

- This feature is not available for all models.

Code (Hexa)	Function	Note	Code (Hexa)	Function	Note
08	 (POWER)	Remote control Button (Power On/Off)	44	OK	Remote control Button
95	ENERGY SAVING	Remote control Button	43	SETTINGS	Remote control Button
30	AV MODE	Remote control Button	28		Remote control Button
0B	INPUT	Remote control Button	5B	EXIT	Remote control Button
F0	TV/RAD	Remote control Button	72	RED	Remote control Button
10-19	Number Key 0-9	Remote control Button	71	GREEN	Remote control Button
53	LIST	Remote control Button	63	YELLOW	Remote control Button
1A	Q.VIEW	Remote control Button	61	BLUE	Remote control Button
02	 +	Remote control Button	20	TEXT	Remote control Button
03	 -	Remote control Button	21	T.OPT (T.Option)	Remote control Button
1E	FAV	Remote control Button	39	SUBTITLE	Remote control Button
79	RATIO	Remote control Button	B1		Remote control Button
09	MUTE	Remote control Button	B0		Remote control Button
00	P ^ / PAGE ^	Remote control Button	BA		Remote control Button
01	P v / PAGE v	Remote control Button	8E		Remote control Button
AB	GUIDE	Remote control Button	8F		Remote control Button
0C	PORTAL	Remote control Button	7E	SIMPLINK	Remote control Button
AA	INFO	Remote control Button	45	Q.MENU	Remote control Button
40	^	Remote control Button	91	AD	Remote control Button
41	v	Remote control Button	E8	ALARM	Remote control Button
07	<	Remote control Button	7C	SMART	Remote control Button
06	>	Remote control Button	DC	3D	Remote control Button

EXTERNAL CONTROL DEVICE SETUP

RS-232C Setup

Connect the RS-232C (serial port) input jack to an external control device (such as a computer or an A/V control system) to control the product's functions externally.

Connect the serial port of the control device to the RS-232C jack on the product back panel.



NOTE

- RS-232C connection cables are not supplied with the product.

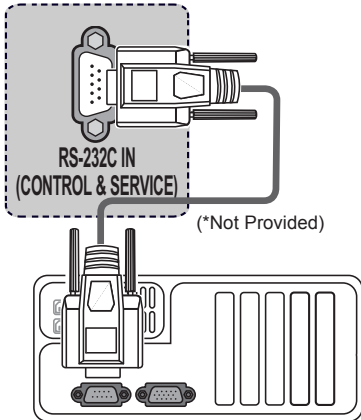

Type of Connector: D-Sub 9-Pin Male

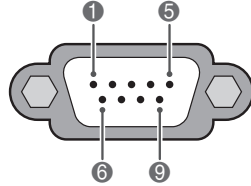

No.	Pin name
1	3.5V
2	RXD (Receive data)
3	TXD (Transmit data)
4	IR OUT from TV
5	GND
6	No Connection
7	<ul style="list-style-type: none"> • No Connection (Only 22/28LW75**, LW76**) • No Connection (5V available in some models - Only 32/39/42/47LW75**, LY75**, LY76**, LY96**)
8	No Connection
9	<ul style="list-style-type: none"> • No Connection (Only 22/28LW75**, LW76**) • No Connection (12V available in some models - Only 32/39/42/47LW75**, LY75**, LY76**, LY96**)

RS-232C Configurations

7-Wire Configurations (Standard RS-232C cable)

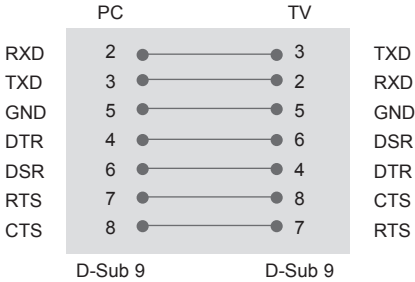

3-Wire Configurations (Not standard)

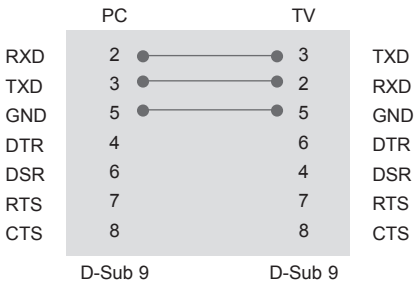

Set ID

Set ID number. "Real Data Mapping".

- 1 Press **SETTINGS** or **HOME** to access the main menus.
- 2 Press the Navigation buttons to scroll to **OPTION** and press **OK**.
- 3 Press the Navigation buttons to scroll to **Set ID** and press **OK**.
- 4 Scroll left or right to select a set ID number and select **Close**. The adjustment range is 1-99.
- 5 When you are finished, press **EXIT**.

Communication Parameters

- Baud rate : 9600 bps (UART)
- Data length : 8 bits
- Parity : None
- Stop bit : 1 bit
- Communication code : ASCII code
- Use a crossed (reverse) cable.

Command Reference List

(Depending on Model)

	COM-MAND1	COM-MAND2	DATA (Hexadecimal)		COM-MAND1	COM-MAND2	DATA (Hexadecimal)
01. Power	k	a	00 to 01	12. Remote Control Lock Mode	k	m	00 to 01
02. Aspect Ratio	k	c	(See p. 51)	13. Balance	k	t	00 to 64
03. Screen Mute	k	d	(See p. 51)	14. Colour Temperature	x	u	00 to 64
04. Volume Mute	k	e	00 to 01	15. Energy Saving	j	q	00 to 05
05. Volume Control	k	f	00 to 64	16. Auto Configure	j	u	01
06. Contrast	k	g	00 to 64	17. Equalize	j	v	(See p. 53)
07. Brightness	k	h	00 to 64	18. Tune Command	m	a	(See p. 53)
08. Colour	k	i	00 to 64	19. Programme Add/Skip	m	b	00 to 01
09. Tint	k	j	00 to 64	20. Key	m	c	(See p. 54)
10. Sharpness	k	k	00 to 32	21. Control Back Light	m	g	00 to 64
11. OSD Select	k	l	00 to 01	22. Input select	x	b	(See p. 54)



NOTE

- During USB operations such as DivX or EMF, all commands except Power(ka) and Key(mc) are not executed and treated as NG.

Transmission / Receiving Protocol

Transmission

[Command1][Command2][][Set ID][][Data][Cr]

- [Command 1] : First command to control the TV.(j, k, m or x)
- [Command 2] : Second command to control the TV.
- [Set ID] : You can adjust the set ID to choose desired monitor ID number in option menu.
Adjustment range is 1 to 99. When selecting Set ID '0', every connected set is controlled.
Set ID is indicated as decimal (1 to 99) on menu and as Hexa decimal (0x0 to 0x63) on transmission/receiving protocol.
- [Data] : To transmit command data. Transmit 'FF' data to read status of command.
- [Cr] : Carriage Return
ASCII code '0x0D'
- [] : ASCII code 'space (0x20)'

OK Acknowledgement

[Command2][][Set ID][][OK][Data][x]

- * The set transmits ACK (acknowledgement) based on this format when receiving normal data. At this time, if the data is data read mode, it indicates present status data. If the data is data write mode, it returns the data of the PC computer.

Error Acknowledgement

[Command2][][Set ID][][NG][Data][x]

- * The set transmits ACK (acknowledgement) based on this format when receiving abnormal data from non-viable functions or communication errors.

Data 00 : Illegal Code

01. Power (Command: k a)

- ▶ To control Power On/Off of the set.

Transmission [k][a][][Set ID][][Data][Cr]

Data 00 : Power Off 01 : Power On

Ack [a][][Set ID][][OK/NG][Data][x]

- ▶ To Show TV is Power On/Off.

Transmission [k][a][][Set ID][][FF][Cr]

Ack [a][][Set ID][][OK/NG][Data][x]

- * Similarly, if other functions transmit '0xFF' data based on this format, Acknowledgement data feed back presents status about each function.
- * OK Ack., Error Ack. and other message may display on the screen when TV is power On.

02. Aspect Ratio (Command: k c)

(Main Picture Size)

- ▶ To adjust the screen format. (Main picture format) You can also adjust the screen format using the Aspect Ratio n the Q.MENU. or PICTURE menu.

Transmission [k][c][][Set ID][][Data][Cr]

Data 01 : Normal screen 07 : 14:9
 (4:3) 09 : Just Scan
 02 : Wide screen 0B : Full Wide
 (16:9) 10 to 1F : Cinema
 04 : Zoom Zoom 1 to 16
 06 : Original

Ack [c][][Set ID][][OK/NG][Data][x]

- * Using the PC input, you select either 16:9 or 4:3 screen aspect ratio.
- * In DTV/HDMI (1080i 50 Hz / 60 Hz, 720p 50Hz / 60 Hz, 1080p 24 Hz / 30 Hz / 50 Hz / 60 Hz), Component (720p, 1080i, 1080p 50 Hz / 60 Hz) mode, Just Scan is available.
- * Full Wide is supported only for Digital, Analogue, AV.

03. Screen Mute (Command: k d)

- ▶ To select screen mute on/off.

Transmission [k][d][][Set ID][][Data][Cr]

Data 00 : Screen mute off (Picture on)
 Video mute off
 01 : Screen mute on (Picture off)
 10 : Video mute on

Ack [d][][Set ID][][OK/NG][Data][x]

- * In case of video mute on only, TV will display On Screen Display(OSD). But, in case of Screen mute on, TV will not display OSD.

04. Volume Mute (Command: k e)

- ▶ To control volume mute on/off.
 You can also adjust mute using the MUTE button on remote control.

Transmission [k][e][][Set ID][][Data][Cr]

Data 00 : Volume mute on (Volume off)
 01 : Volume mute off (Volume on)

Ack [e][][Set ID][][OK/NG][Data][x]

05. Volume Control (Command: k f)

- ▶ To adjust volume.
 You can also adjust volume with the volume buttons on remote control.

Transmission [k][f][][Set ID][][Data][Cr]

Data Min : 00 to Max : 64

- * Refer to 'Real data mapping'. See p. 54.

Ack [f][][Set ID][][OK/NG][Data][x]

06. Contrast (Command: k g)

- ▶ To adjust screen contrast.
 You can also adjust contrast in the PICTURE menu.

Transmission [k][g][][Set ID][][Data][Cr]

Data Min : 00 to Max : 64

- * Refer to 'Real data mapping'. See p. 54.

Ack [g][][Set ID][][OK/NG][Data][x]

07. Brightness (Command: k h)

- ▶ To adjust screen brightness.
You can also adjust brightness in the PICTURE menu.

Transmission [k][h][][Set ID][][Data][Cr]

Data Min : 00 to Max : 64

- * Refer to 'Real data mapping'. See p. 54.

Ack [h][][Set ID][][OK/NG][Data][x]

08. Colour (Command: k i)

- ▶ To adjust the screen Colour.
You can also adjust colour in the PICTURE menu.

Transmission [k][i][][Set ID][][Data][Cr]

Data Min : 00 to Max : 64

- * Refer to 'Real data mapping'. See p. 54.

Ack [i][][Set ID][][OK/NG][Data][x]

09. Tint (Command: k j)

- ▶ To adjust the screen tint.
You can also adjust tint in the PICTURE menu.

Transmission [k][j][][Set ID][][Data][Cr]

Data Red : 00 to Green : 64

- * Refer to 'Real data mapping'. See p. 54.

Ack [j][][Set ID][][OK/NG][Data][x]

10. Sharpness (Command: k k)

- ▶ To adjust the screen sharpness.
You can also adjust sharpness in the PICTURE menu.

Transmission [k][k][][Set ID][][Data][Cr]

Data Min : 00 to Max : 32

- * Refer to 'Real data mapping'. See p. 54.

Ack [k][][Set ID][][OK/NG][Data][x]

11. OSD Select (Command: k l)

- ▶ To select OSD (On Screen Display) on/off when controlling remotely.

Transmission [k][l][][Set ID][][Data][Cr]

Data 00 : OSD off 01 : OSD on

Ack [l][][Set ID][][OK/NG][Data][x]

12. Remote control lock mode (Command: k m)

- ▶ To lock the front panel controls on the monitor and remote control.

Transmission [k][m][][Set ID][][Data][Cr]

Data 00 : Lock off 01 : Lock on

Ack [m][][Set ID][][OK/NG][Data][x]

- * If you are not using the remote control, use this mode. When main power is on/off, external control lock is released.

- * In the standby mode, if key lock is on, TV will not turn on by power on key of IR & Local Key.

13. Balance (Command: k t)

- ▶ To adjust balance.
You can also adjust balance in the AUDIO menu.

Transmission [k][t][][Set ID][][Data][Cr]

Data L : 00 to R : 64

- * Refer to 'Real data mapping'. See p. 54.

Ack [t][][Set ID][][OK/NG][Data][x]

14. Colour Temperature (Command: x u)

- ▶ To adjust colour temperature. You can also adjust Colour Temperature in the PICTURE menu.

Transmission [x][u][][Set ID][][Data][Cr]

Data Min : 00 to Max : 64

- * Refer to 'Real data mapping'. See p. 54.

Ack [u][][Set ID][][OK/NG][Data][x]

15. Energy Saving (Command: j q)

- ▶ To reduce the power consumption of the TV. You can also adjust Energy Saving in PICTURE menu.

Transmission [j][q][][Set ID][][Data][Cr]

Power Saving Function				Level	Description	
7	6	5	4			
0	0	0	0	Low Power	0 0 0 0	Off
0	0	0	0	Low Power	0 0 0 1	Minimum
0	0	0	0	Low Power	0 0 1 0	Medium
0	0	0	0	Low Power	0 0 1 1	Maximum
0	0	0	0	Low Power	0 1 0 1	Screen Off
0	0	0	0	Low Power	0 1 0 0	Auto

- ▶ 'Auto' is available in TV that supports 'Intelligent Sensor'.

Ack [q][][Set ID][][OK/NG][Data][x]

16. Auto Configure (Command: j u)
(Only RGB support model)

- ▶ To adjust picture position and minimize image shaking automatically. It works only in RGB (PC) mode.

Transmission [j][u][][Set ID][][Data][Cr]

Data 01 : To set

Ack [u][][Set ID][][OK/NG][Data][x]

17. Equalizer (Command : j v) (Only LW76**, LY76**, LY96**)

- ▶ To adjust equalize.

Transmission [j][v][][Set ID][][Data][Cr]

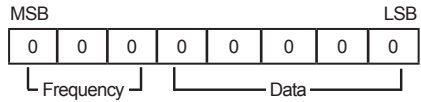

7	6	5	Frequency	4	3	2	1	0	Step
0	0	0	1st Band	0	0	0	0	0	0(decimal)
0	0	1	2nd Band	0	0	0	0	1	1(decimal)
0	1	0	3rd Band
0	1	1	4th Band	0	0	0	1	1	19(decimal)
1	0	0	5th Band	0	0	1	0	1	20(decimal)

Ack [v][][Set ID][][OK/NG][Data][x]

18. Tune Command (Command: m a)

- ▶ Select channel to following physical number.

Transmission [m][a][][Set ID][][Data 00][][Data 01][][Data 02][Cr]

Data 00 : High channel data

Data 01 : Low channel data

ex. No. 47 -> 00 2F (2FH)

No. 394 -> 01 8A (18AH),

DTV No. 0 -> Don't care

Data 02 : [Antenna]

0x00 : Analog Main

0x10 : DTV Main

0x20 : Radio

[Cable]

0x80 : Analog Main

0x90 : DTV Main

0xA0 : Radio

[Satellite - Only LW76**, LY76**, LY96**]

0x40 : DTV Main

0x50 : Radio Main

Channel data range

Analog - Min: 00 to Max: 63 (0 to 99)

Digital - Min: 00 to Max: 3E7 (0 to 999)

Ack [a][][Set ID][][OK/NG][Data][x]

Data Min: 00 to Max: 7DH

19. Programme Add/Skip (Command: m b)

- ▶ To set skip status for the current Programme.

Transmission [m][b][][Set ID][][Data][Cr]

Data 00 : Skip 01 : Add

Ack [b][][Set ID][][OK/NG][Data][x]

20. Key (Command: m c)

- ▶ To send IR remote key code.

Transmission [m][c][][Set ID][][Data][Cr]

Data Key code - See p. 46.

Ack [c][][Set ID][][OK/NG][Data][x]

21. Control Backlight (Command: m g)

- ▶ To control the backlight.

Transmission [m][g][][Set ID][][Data][Cr]

Data Min : 00 to Max : 64

Ack [g][][Set ID][][OK/NG][Data][x]

22. Input select (Command: x b)
(Main Picture Input)

- ▶ To select input source for main picture.

Transmission [x][b][][Set ID][][Data][Cr]

Data Structure

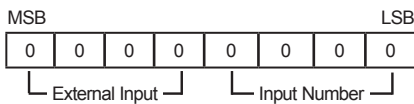

External Input				Data
0	0	0	0	DTV
0	0	0	1	Analogue
0	0	1	0	AV
0	1	0	0	Component
0	1	1	0	RGB
0	1	1	1	HDMI
1	0	0	0	
1	0	0	1	
1	0	1	0	

Input Number				Data
0	0	0	0	Input1
0	0	0	1	Input2
0	0	1	0	Input3
0	0	1	1	Input4

Ack [b][][Set ID][][OK/NG][Data][x]

* Real data mapping	
00 :	Step 0
:	:
A :	Step 10 (Set ID 10)
:	:
F :	Step 15 (Set ID 15)
10 :	Step 16 (Set ID 16)
:	:
64 :	Step 100
:	:
6E :	Step 110
:	:
73 :	Step 115
74 :	Step 116
:	:
CF :	Step 199
:	:
FE :	Step 254
FF :	Step 255



Record the model number and serial number of the TV.

Refer to the label on the back cover and quote this information to your dealer when requiring any service.

MODEL _____

SERIAL _____

