



# OWNER'S MANUAL

# LED MONITOR\*

\*LG LED Monitors are LCD Monitors with LED Backlighting.

Please read the safety information carefully before using the product.

## LED Monitor Model List

24GM77

# TABLE OF CONTENTS

## 3 LICENSE

---

## 4 ASSEMBLING AND PREPARING

---

- 4 Product Composition
- 5 Component and Button Description
- 6 - How to Use the Joystick Button
- 7 Moving and Lifting the Monitor
- 8 Installing the Monitor
- 8 - Assembling the Stand Base
- 9 - Detaching the Stand Base
- 9 - Installing on to a Table
- 10 - Adjusting the Stand Height
- 11 - Adjusting the Angle
- 11 - Tidying Cables
- 12 - Pivot Feature
- 13 - Using the Kensington Lock
- 13 - Detaching the Stand Body
- 14 - Installing the Wall Mount Plate
- 14 - Installing on the Wall

## 16 USING THE MONITOR

---

- 16 Connecting to a PC
- 16 - HDMI Connection
- 17 - DisplayPort Connection
- 17 - D-SUB Connection
- 18 - DVI Connection
- 18 Connecting AV Devices
- 18 - HDMI Connection
- 19 Connecting Peripherals
- 19 - USB Cable Connection - PC
- 20 - Headphone Port Connection

## 21 USER SETTINGS

---

- 21 Activating the Main Menu
- 21 - Main Menu Features
- 22 User Settings
- 22 - Menu Settings
- 23 - Ratio
- 24 - Function
- 27 - Picture
- 29 - Color
- 30 - Display
- 31 - Settings
- 32 - Auto Configuration
- 33 - Reset

## 34 TROUBLESHOOTING

---

## 36 PRODUCT SPECIFICATION

---

- 37 Factory Support Mode  
(Preset Mode, DisplayPort/D-SUB/DVI-D/  
HDMI PC)
- 37 HDMI Timing (Video)
- 37 Power LED

## 38 PROPER POSTURE

---

- 38 Proper Posture for Using the Monitor

**WARNING:** This product contains chemicals known to the State of California to cause cancer and birth defects or other reproductive harm. **Wash hands after handling.**

# LICENSE

Each model has different licenses. Visit [www.lg.com](http://www.lg.com) for more information on the license.



The terms HDMI and HDMI High-Definition Multimedia Interface, and the HDMI logo are trademarks or registered trademarks of HDMI Licensing LLC in the United States and other countries.



VESA, VESA logo, Display Port Compliance Logo and Display Port Compliance Logo for dual-mode source are all registered trademarks of the Video Electronics Standards Association.

# ASSEMBLING AND PREPARING

## Product Composition

Please check whether all the components are included in the box before using the product. If there are missing components, contact the retail store where you purchased the product. Note that the product and components may look different from those shown here.

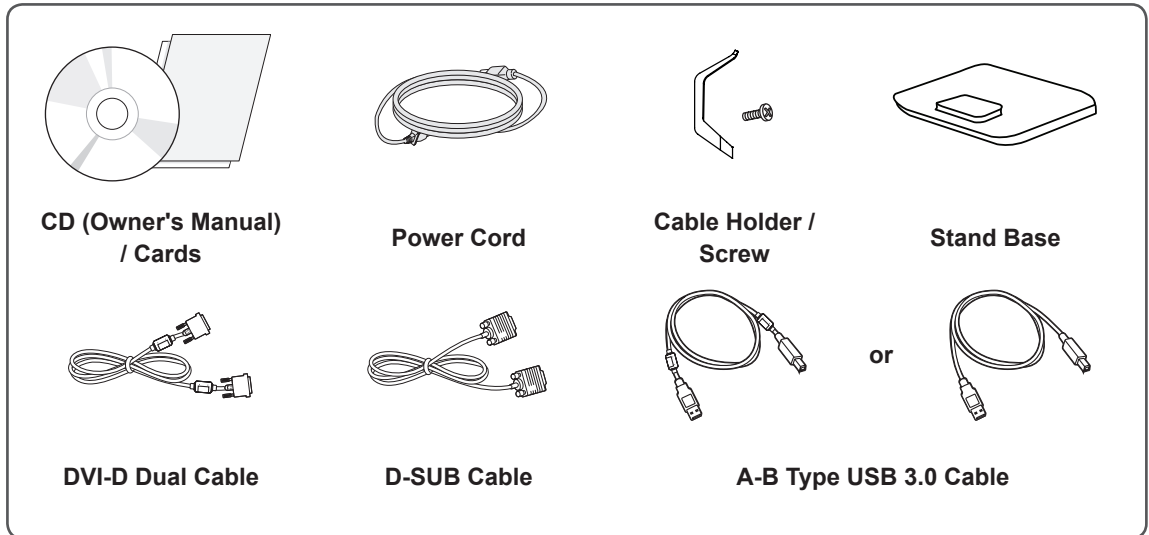

### CAUTION

- Always use genuine components to ensure safety and product performance.
- The product warranty will not cover damage or injury caused by the use of unauthorized components.



### NOTE

- The components may look different from those illustrated here.
- Without prior notice, all product information and specifications contained in this manual are subject to change to improve the performance of the product.
- To purchase optional accessories, visit an electronics store or an online shopping site, or contact the retailer from which you purchased the product.
- The power cord provided may differ depending upon the region.

## Component and Button Description

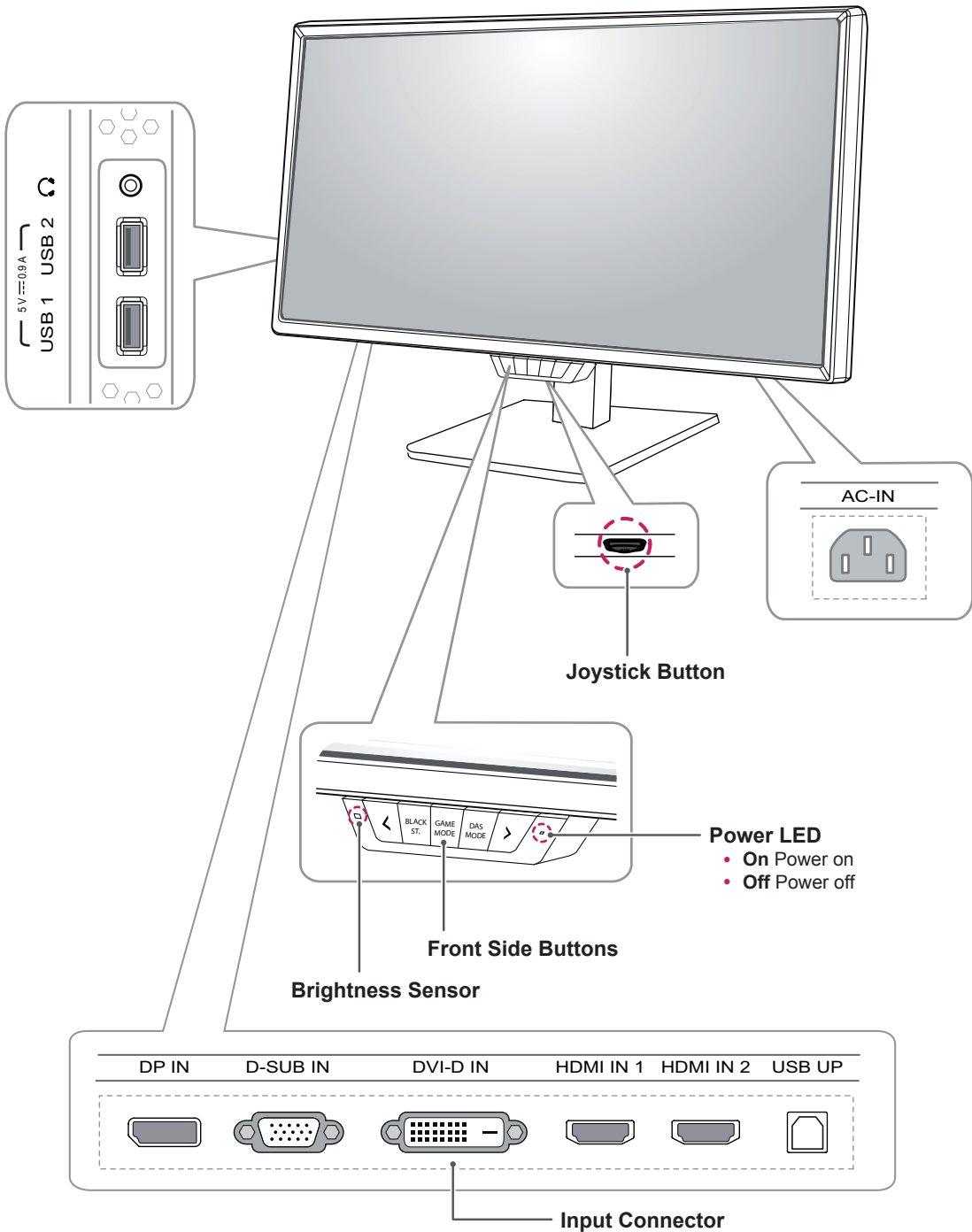





### NOTE

- The Brightness Sensor senses the amount of exterior light so that the processor can make necessary adjustments to the brightness level to compensate.
- The joystick button is located at the bottom of the monitor.

## How to Use the Joystick Button

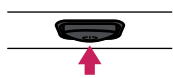
You can easily control the functions of the monitor by pressing the joystick button or moving it left/right with your finger.

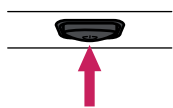
### Basic Functions

		<b>Power on</b>	Press the joystick button once with your finger to turn on the monitor.
		<b>Power off</b>	Press and hold the joystick button once with your finger to turn off the monitor.
		<b>Volume Control</b>	You can control the volume by moving the joystick button left/right.

## Moving and Lifting the Monitor

When moving or lifting the monitor, follow these instructions to prevent the monitor from being scratched or damaged and to ensure safe transportation, regardless of its shape or size.

- It is advisable to place the monitor in the original box or packing material before attempting to move it.
- Before moving or lifting the monitor, disconnect the power cord and all cables.
- Hold the top and bottom of the monitor frame firmly. Do not hold the panel itself.

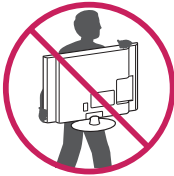
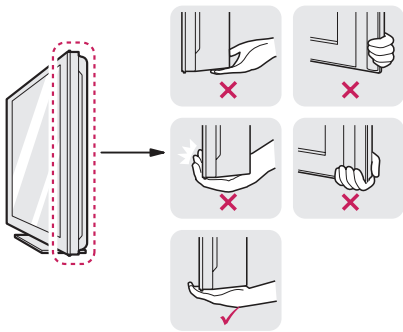

- When holding the monitor, the screen should face away from you to prevent it from being scratched.
- When transporting the monitor, do not expose the monitor to jolts or excessive vibration.
- When moving the monitor, keep it upright and never turn the monitor on its side or tilt it sideways.



### CAUTION

- Avoid touching the monitor screen as much as possible. Do not apply pressure.
  - This may result in damage to the screen or some of the pixels used to create images.

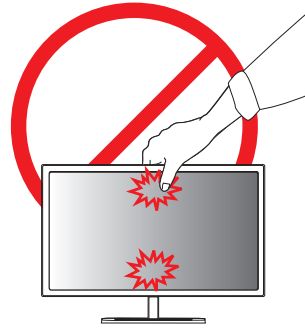

- If you use the monitor panel without the stand base, its joystick button may cause the monitor to become unstable and fall, resulting in damage to the monitor or human injury. In addition, this may cause the joystick button to malfunction.

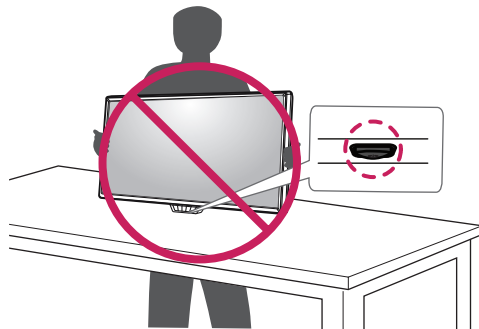

## Installing the Monitor

### Assembling the Stand Base

- 1 Place the screen face down.
- 2 Rotate the **Stand Body** 90° counter clockwise.

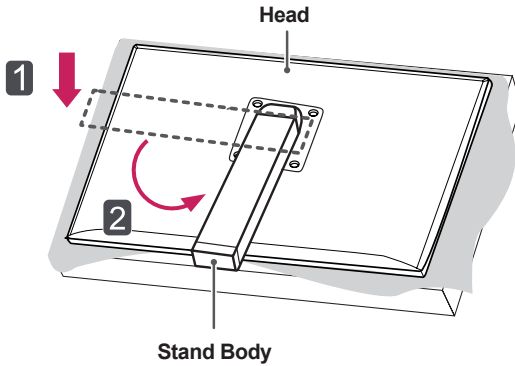

#### CAUTION

- To protect the screen from scratches, cover the surface with a soft cloth.
- To avoid scratching the head, make sure that when rotating the **Stand Body**, the stand body does not make contact with the head.

- 3 Align the hole on the **Stand Base** with the **Stand Body** and push it all the way up. Turn the screws on the **Stand Base** to the right.

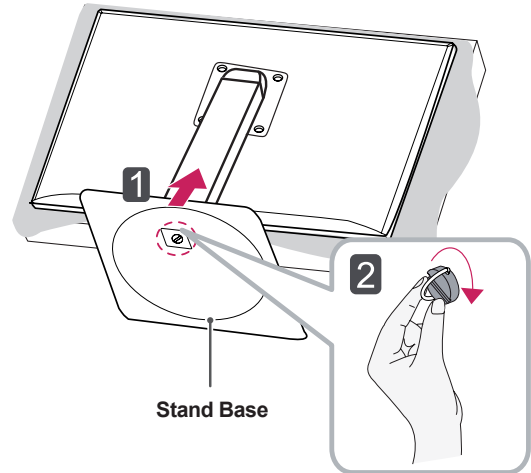

#### CAUTION

- Applying excessive force when tightening screws may cause damage to the monitor. Damage caused in this way will not be covered by the product warranty.



## Detaching the Stand Base

- 1 Place the screen face down.



### CAUTION

- To protect the screen from scratches, cover the surface with a soft cloth.

- 2 BodyTurn the screws on the **Stand Base** to the left to detach the **Stand Base** from the **Stand Body**.

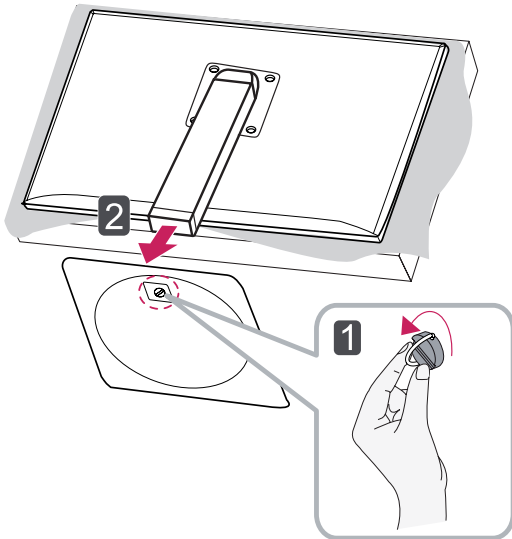

### CAUTION

- The components in the illustrations may differ from the actual product.
- Do not carry the monitor upside down, as this may cause it to fall off its stand and result in damage or injury.
- To avoid damaging the screen when lifting or moving the monitor, only hold the stand or the plastic cover. This avoids putting unnecessary pressure on the screen.

## Installing on to a Table

- 1 Lift the monitor and place it on the table in an upright position. Place at least **10 cm (4 inches)** away from the wall to ensure sufficient ventilation.

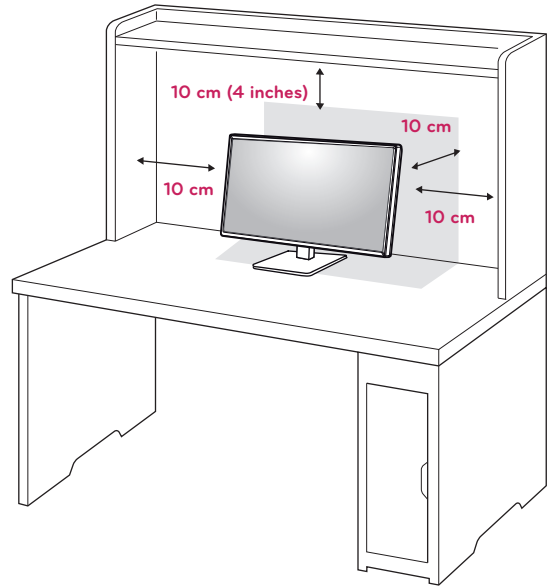

- 2 Connect the **Power Cord** to a wall outlet.

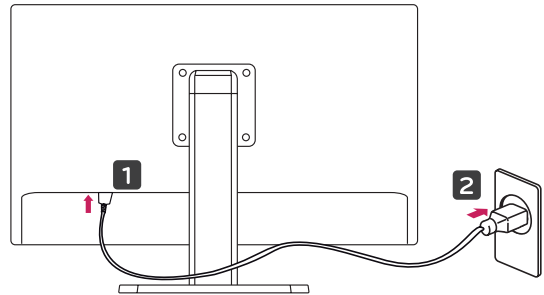

- 3 Press the **Power** button on the bottom of the monitor to turn it on.



### CAUTION

- To avoid the risk of electric shock, disconnect the Power Cord before moving or installing the monitor.

## Adjusting the Stand Height

- 1 Place the monitor mounted on the stand base in an upright position.
- 2 Push the **Head** downward and pull out the **Locking Pin**.

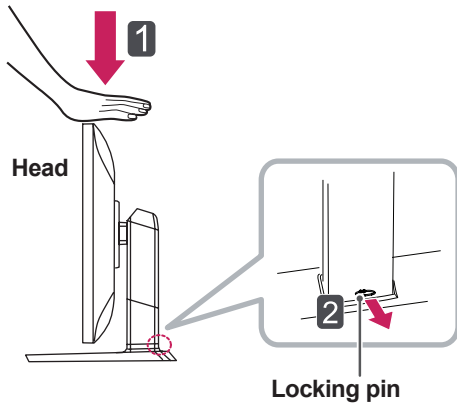

- 3 Handle the monitor with both hands for safety.

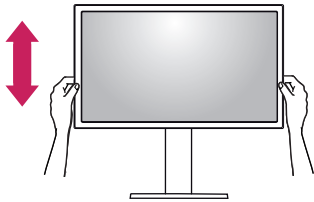

- 4 The height can be adjusted up to **100.0 mm (approx. 4 inches)**.

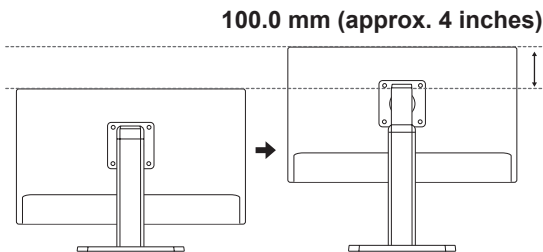

### ! CAUTION

- Once the pin is removed, it is not necessary to re-insert it to adjust the height.
- Problems with the height or angle adjustment of the product caused by the attachment of protective glass in Internet cafes specializing in gaming will not be covered by the warranty.

### ! WARNING



- To avoid injury, do not put your fingers or hand between the head and the base when adjusting the screen's height.

## Adjusting the Angle

- 1 Place the monitor in an upright position, mounted on the stand base.
- 2 Adjust the angle of the screen. The angle of the screen can be adjusted forwards or backwards from  $-5^{\circ}$  to  $20^{\circ}$  for a comfortable viewing experience.

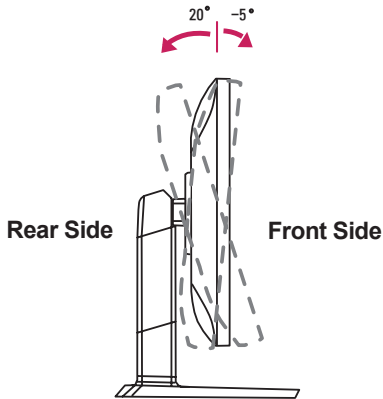

### **!** WARNING

- To avoid injury, do not put your fingers or hand between the head and the base when adjusting the screen's angle or height.

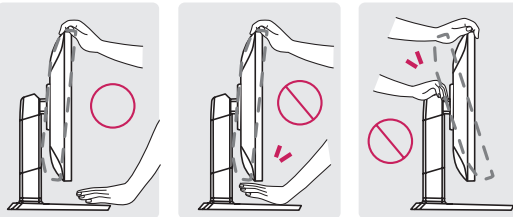

- Be careful not to touch or press the screen area when adjusting the angle of the monitor.

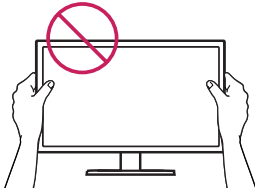

### **!** CAUTION

- Problems with the height or angle adjustment of the product caused by the attachment of protective glass in Internet cafes specializing in gaming will not be covered by the warranty.

## Tidying Cables

- 1 Use the screw provided to attach the cable holder to the stand body as illustrated.

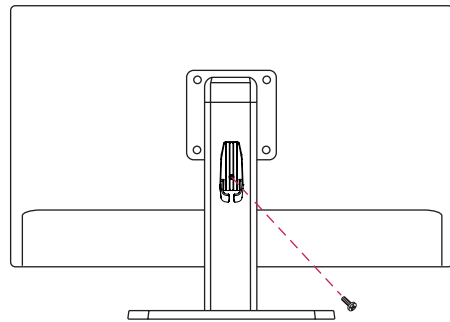

- 2 Gather and bind the cables with the supplied cable holder.

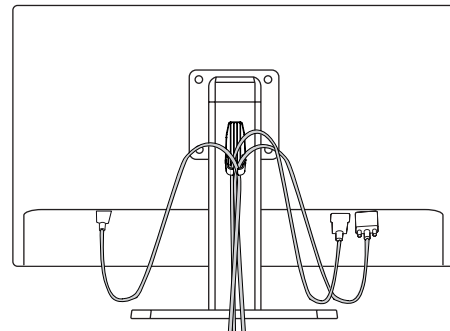

## Pivot Feature

The pivot feature allows the monitor to rotate 90° clockwise.

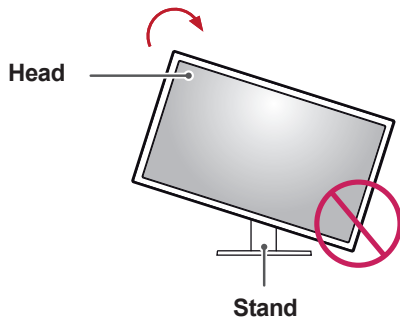

### ! WARNING

- To avoid scratching the stand base, make sure that when rotating the monitor using the pivot feature, the stand does not make contact with the monitor.

- 1 Raise the monitor to the maximum height.

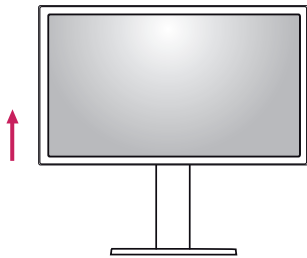

- 2 Adjust the angle of the monitor in the direction of the arrow as shown in the figure.

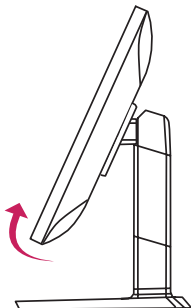

- 3 Rotate the monitor clockwise as shown in the figure.

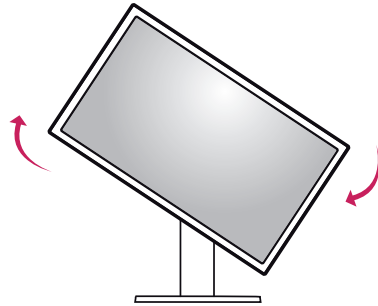

- 4 Complete the installation by rotating the monitor 90° as shown below.



### ! NOTE

- Auto Pivot feature of the display is not supported.
- The screen can be rotated easily using the screen pivot shortcut key provided with your Windows operating system. Note that some Windows versions may use different settings for the screen pivot key or may not support the pivot key at all.
- Supported Windows versions: Windows 7 and Windows 8
- Windows screen pivot shortcut keys
  - 0°: Ctrl + Alt + Up arrow key (↑)
  - 90°: Ctrl + Alt + Left arrow key (←)
  - 180°: Ctrl + Alt + Down arrow key (↓)
  - 270°: Ctrl + Alt + Right arrow key (→)

**! WARNING**

- Take care when rotating the monitor if the cable is connected.
- To avoid injury when rotating the display, do not place your fingers between the display and the stand base.

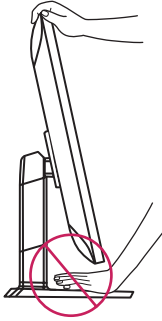
**Using the Kensington Lock**

The Kensington security system connector is located at the back of the Monitor set. For more information on installation and usage, refer to the Kensington lock user manual or visit the website at <http://www.kensington.com>.

Connect the Kensington security system cable between the Monitor and a table.

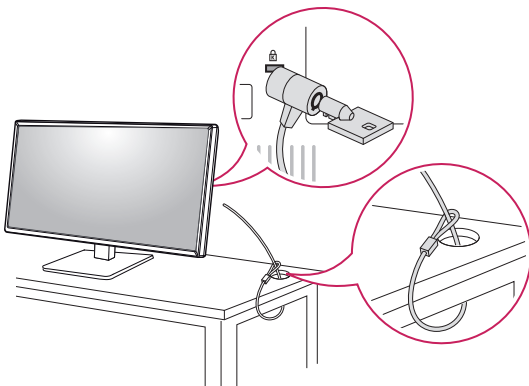
**! NOTE**

- The Kensington security system is optional. You can obtain additional accessories from most electronics stores.

**Detaching the Stand Body**

- 1 Place the monitor's screen face down. To protect the screen from scratches, cover the surface with a soft cloth.
- 2 Using a screwdriver, remove the four screws and detach the stand from the monitor.

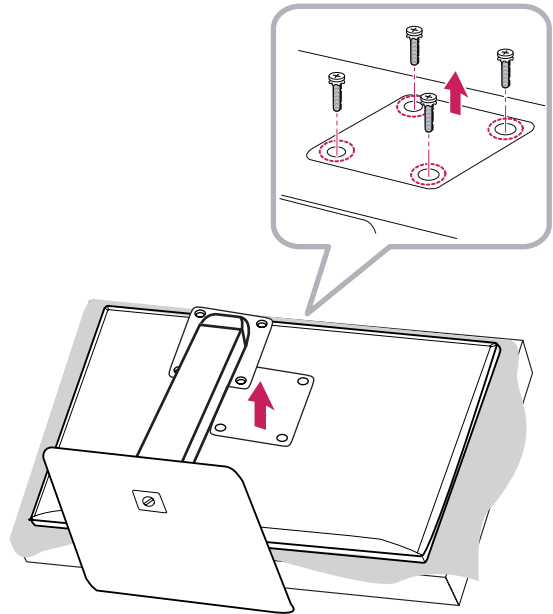

## Installing the Wall Mount Plate

This monitor meets the specifications for the wall mount plate or other compatible devices.

- 1 Place the screen face down. To protect the screen from scratches, cover the surface with a soft cloth.
- 2 Place the wall mount plate onto the monitor and align it with the screw holes.
- 3 Tighten the four screws to fix the plate to the monitor using a screwdriver.

### NOTE

- The wall mount plate is sold separately.
- For more information on installation, refer to the wall mount plate's installation guide.
- Be careful not to apply too much force while mounting the wall mount plate as it may cause damage to the screen

## Installing on the Wall

Install the monitor at least 10 cm (4 inches) away from the wall and leave about 10 cm (4 inches) of space at each side of the monitor to ensure sufficient ventilation. Detailed installation instructions can be obtained from your local retail store. Alternatively, please refer to the manual for how to install and set up a tilting wall mounting bracket.

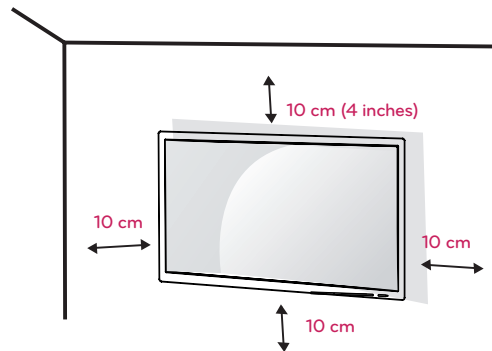

To install the monitor to a wall, attach a wall mounting bracket (optional) to the back of the monitor.

Make sure that the wall mounting bracket is securely fixed to the monitor and to the wall.

- 1 If you use screws longer than the standard length, it may damage the inside of the product.
- 2 A non-VESA standard screw may damage the product and cause the monitor to fall. LG Electronics is not liable for any accidents relating to the use of non-standard screws.

<b>Wall Mount (A x B)</b>	100 x 100
<b>Stand Screw</b>	M4 x 10 mm
<b>Required Screws</b>	4
<b>Wall Mount Plate (Optional)</b>	RW120

- Wall Mount (A x B)

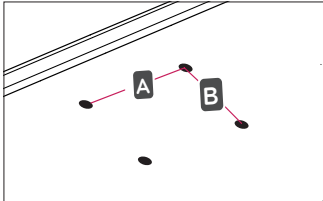

**NOTE**

- Use the screws specified by VESA standards.
- The wall mount kit includes the installation guide and all necessary parts.
- The wall mounting bracket is optional. You can obtain optional accessories from your local dealer.
- The length of the screw may differ for each wall mounting bracket. Be sure to use the proper length.
- For more information, please refer to the user manual for the wall mounting bracket.

**CAUTION**

- Unplug the power cord before moving or installing the monitor to avoid electric shock.
- Installing the monitor on the ceiling or on a slanted wall may result in the monitor falling off, which could lead to injury. Use an authorized LG wall mount and contact the local dealer or qualified personnel.
- Applying excessive force when tightening screws may cause damage to the monitor. Damage caused in this way will not be covered by the product warranty.
- Use the wall mounting bracket and screws that conform to VESA standards. Damage caused by the use or misuse of inappropriate components will not be covered by the product warranty.
- To prevent injury, this apparatus must be securely attached to the wall in accordance with the installation instructions. (This pertains only to Australia and New Zealand.)
- When measured from the back of the monitor, the length of each installed screw must be 8 mm (5/16 inches) or less.

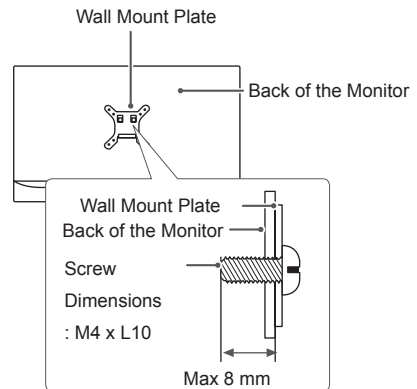

# USING THE MONITOR



## CAUTION

- Do not press on the screen for a prolonged period of time. This may cause image distortion.
- Do not display a still image on the screen for a prolonged period of time. This may cause image retention. Use a screensaver if possible.



## NOTE

- When connecting the power cord to the outlet, use a grounded (3-hole) multi-socket or a grounded power outlet.
- The monitor may flicker when turned on in an area of low temperature. This is normal.
- Sometimes red, green, or blue spots may appear on the screen. This is normal.

## Connecting to a PC

- This monitor supports the \*Plug and Play feature.  
\*Plug and Play: A feature that allows you to add a device to your computer without having to reconfigure anything or install any manual drivers.

## HDMI Connection

Transmits digital video and audio signals from your PC to the monitor. Connect your PC to the monitor using the HDMI cable as shown in the illustration below.

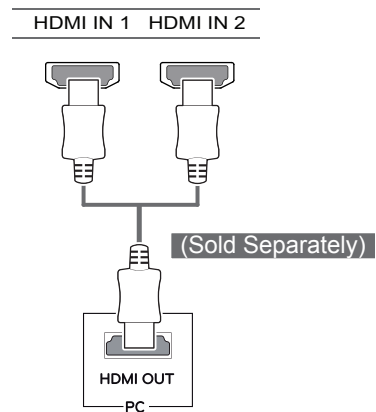

## CAUTION

- Connecting your PC to the monitor using the HDMI cable may cause device compatibility issues.
- Using a DVI to HDMI / DP(DisplayPort) to HDMI cable may cause compatibility issues.
- Use a certified cable with the HDMI logo attached. If you do not use a certified HDMI cable, the screen may not display or a connection error may occur.
- Recommended HDMI cable types
  - High-Speed HDMI<sup>®</sup>/™ Cable
  - High-Speed HDMI<sup>®</sup>/™ Cable with Ethernet



## DisplayPort Connection

Transmits digital video and audio signals from your PC to the monitor. Connect the monitor to your PC using the display port cable as shown in the illustration below:

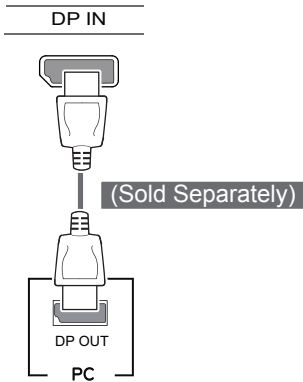

**NOTE**

- There may be no video or audio output depending on the DP (DisplayPort) version of the PC.
- When using a Mini DP to DP (Mini DisplayPort to DisplayPort) cable, a cable with DisplayPort 1.1a specifications or above is recommended.

## D-SUB Connection

Transmits the analog video signal from your PC to the monitor. Connect the monitor to the PC using the provided 15-pin D-Sub signal cable as illustrated below.

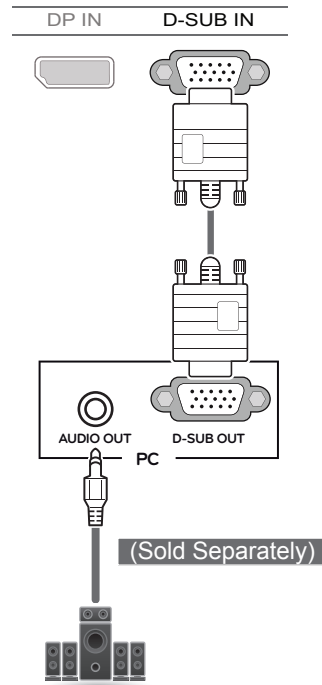

**CAUTION**

- Connect the input signal cable and turn in the direction of the arrow. To prevent disconnection secure the cable firmly, do not over tighten.

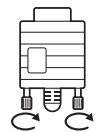

**NOTE**

- **Apple® Adapter**  
If you are using an Apple® computer, an Apple® adapter is required. The adapter can be purchased at an Apple® store.

## DVI Connection

Transmits digital video signals to the monitor. Connect the monitor using the DVI cable as illustrated below.

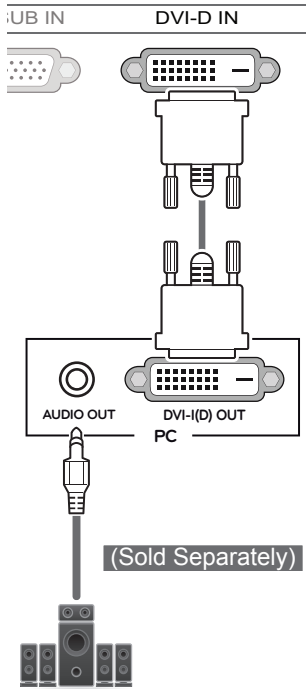

### CAUTION

- Connect the input signal cable and turn in the direction of the arrow. To prevent disconnection secure the cable firmly, do not over tighten.

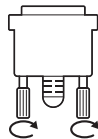

### NOTE

- Using a DVI to HDMI cable may cause compatibility issues.
- If you connect a DVI signal cable, use the DVI-D dual cable.

## Connecting AV Devices

### HDMI Connection

HDMI transmits digital video and audio signals from your AV device to the monitor. Connect your AV device to the monitor using the HDMI cable as shown in the illustration below.

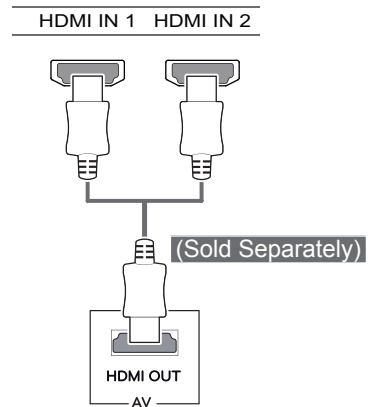

### NOTE

- Using a DVI to HDMI / DP(DisplayPort) to HDMI cable may cause compatibility issues.
- Use a certified cable with the HDMI logo attached. If you do not use a certified HDMI cable, the screen may not display or a connection error may occur.
- Recommended HDMI cable types
  - High-Speed HDMI<sup>®</sup>/™ Cable
  - High-Speed HDMI<sup>®</sup>/™ Cable with Ethernet

## Connecting Peripherals

### USB Cable Connection - PC

The USB port on the product functions as a USB hub.

**NOTE**

- Make sure to install the most recent Windows OS service pack before using the product.
- Peripheral devices are sold separately.
- A keyboard, mouse, or USB device can be connected to the USB port.

**CAUTION**

**Cautions When Using a USB Device**

- A USB device with an automatic recognition program installed or that uses its own driver may not be recognized.
- Some USB devices may not be supported or may not work properly.
- It is recommended to use a USB hub or hard disk drive with an external power supply. (If the power supply is not adequate, the USB device may not be recognized properly.)

To use USB 3.0, connect the A-B type USB 3.0 cable of the product to the PC. Peripheral devices connected to the USB 1, 2 port can be controlled from the PC.

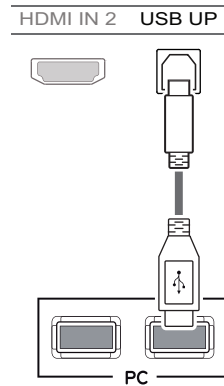
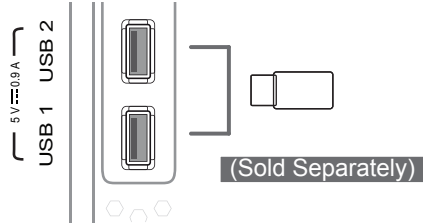

## Headphone Port Connection

Use the headphone port to connect a peripheral device to the monitor. Connect as illustrated.

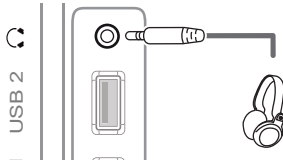

(Sold Separately)



### NOTE

- Peripheral devices are sold separately.
- It is difficult to connect an angle plug earphone or a peripheral device, so please use a straight type plug.



**Angle Type**

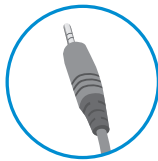

**Straight Type**

- Depending on the audio settings of the PC and external device, headphone and speaker functions may be limited.

# USER SETTINGS

## Activating the Main Menu

- 1 Press the **joystick button** on the bottom of the monitor.
- 2 Move the joystick up/down (▲/▼) and left/right (◀/▶) to set the options.
- 3 Press the joystick button once more to exit the main menu.

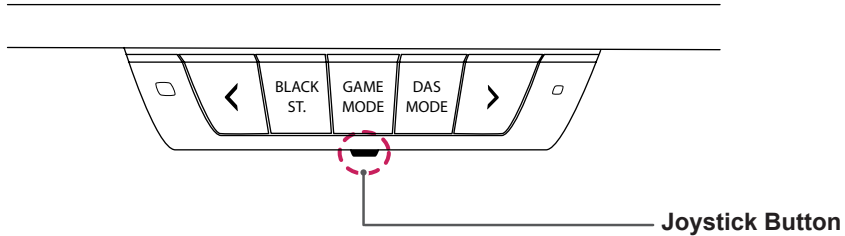

Button	Menu Status	Description
	Main menu disabled	Enables the main menu.
	Main menu enabled	Exits the main menu. (Press and hold the button to turn off the monitor: You can turn off the monitor using this method at any time, including when the OSD (On Screen Display) is on.)
	◀ Main menu disabled	Adjusts the monitor volume level.
	◀ Main menu enabled	Enters the menu features.
	▶ Main menu disabled	Adjusts the monitor volume level.
	▶ Main menu enabled	Enters the input feature.
	▲ Main menu disabled	Enables the main menu.
	▲ Main menu enabled	Enters the picture mode feature.
	▼ Main menu disabled	Enables the main menu.
	▼ Main menu enabled	Turns the monitor off.

## Main Menu Features

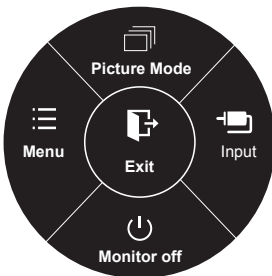

Main Menu	Description
Menu	Configures the screen settings.
Picture Mode	Optimizes the screen for picture mode.
Input	Sets input mode.
Monitor off	Turns off the monitor.
Exit	Exits the main menu.

⓪ Long Press: Monitor Off.

## User Settings

### Menu Settings

- 1 To view the **OSD menu**, press the **joystick button** on the bottom of the monitor and then enter the **Menu**.
- 2 Configure the options by moving the joystick up/down/left/right.
- 3 If you want to configure an upper menu or another option, move the joystick ◀ or press it (⊙ / OK).
- 4 If you want to exit the OSD menu, move the joystick ◀ until you exit.
  - When you enter the menu, instructions on how to use the button will appear in the bottom right corner of the screen.



Easy control



Function



Screen



Settings

Auto  
Configuration

Reset

Each option is described below.

Menu		Description
Easy control	Brightness	Adjusts the screen brightness.  <div style="border: 1px solid black; border-radius: 10px; padding: 5px;"> <p><b>NOTE</b></p> <ul style="list-style-type: none"> <li>• You can turn the auto brightness adjustment on/off by moving the joystick button ▼ in the Brightness menu.</li> </ul> </div>
	Contrast	Adjusts the screen contrast.
	Volume	Adjusts the volume level.  <div style="border: 1px solid black; border-radius: 10px; padding: 5px;"> <p><b>NOTE</b></p> <ul style="list-style-type: none"> <li>• You can turn mute on/off by moving the joystick button ▼ in the Volume menu.</li> </ul> </div>
	Input	Selects the input mode.
	Ratio	Adjusts the aspect ratio of the screen.
Function		Adjusts Picture Mode, Game Mode, DAS Mode, Motion 240, and SUPER ENERGY SAVING.
Screen	Picture	Adjusts SUPER RESOLUTION+, Sharpness, Black Level, Black Stabilizer, and Response Time of the screen.
	Color	Adjusts the Gamma, Color Temp, and Color.
	Display	Adjusts Position, Width, and Phase of the screen. (Activated only when using a D-Sub Analog input.)
Settings		Adjusts Language, Power LED, Automatic Standby, and OSD Lock.
Auto Configuration		Adjusts the Position, Width, and Phase of the screen automatically. (Activated only when using a D-Sub Analog input.)
Reset		Restores the default settings.
◀	Exit	Exits the OSD menu.

## Ratio

- 1 To view the **OSD menu**, press the **joystick button** on the bottom of the monitor and then enter the **Menu**.
- 2 Go to **Easy control > Ratio** by moving the joystick.
- 3 Configure the options following the instructions that appear in the bottom right corner.
- 4 If you want to configure an upper menu, or another option, move the joystick to ◀ or press it (⊙ / OK).
- 5 If you want to exit the OSD menu, move the joystick to ◀ until you exit.

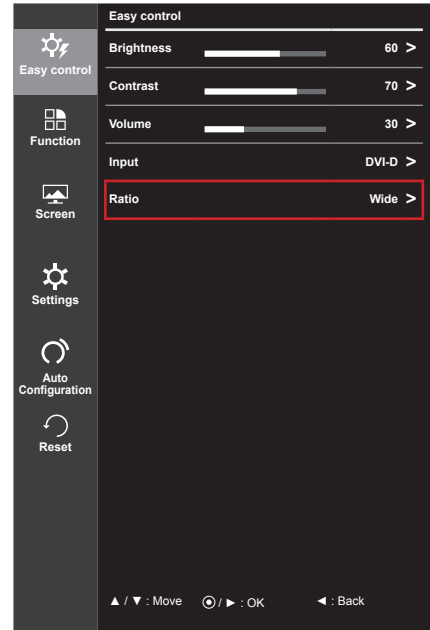

Each option is described below.

Menu > Easy control > Ratio	Description
<b>Wide</b>	Displays the video in wide screen, regardless of the video signal input.
<b>Original</b>	Displays the video according to the aspect ratio of the video signal input.
<b>1:1</b>	The aspect ratio is not adjusted from the original. <div style="border: 1px solid black; padding: 5px; margin-top: 10px;"> <p><b>NOTE</b></p> <ul style="list-style-type: none"> <li>This function is not available when the DAS mode is turned on. To use the 1:1 mode, you should turn the DAS mode off.</li> </ul> </div>

- NOTE**
- The display may look the same for Wide, Original, and 1:1 options at the recommended resolution (1920 x 1080).
  - Ratio is disabled with an interlaced signal.

## Function

- 1 To view the **OSD menu**, press the **joystick button** on the bottom of the monitor and then enter the **Menu**.
- 2 Go to **Function** by moving the joystick.
- 3 Configure the options following the instructions that appear in the bottom right corner.
- 4 If you want to configure an upper menu, or another option, move the joystick ◀ or press it (● / OK).
- 5 If you want to exit the OSD menu, move the joystick ◀ until you exit.

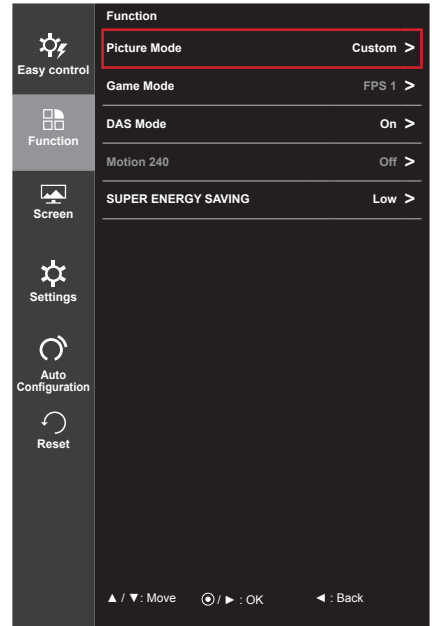

Each option is described below.

Menu > Function	Description	
<b>Picture Mode</b> (Move the joystick to ▲ in the main menu to enter Picture Mode directly.)	<b>Reader 1</b>	Optimizes the screen for browsing newspapers. You can brighten the screen in the OSD menu.
	<b>Reader 2</b>	Optimizes the screen for reading comics. You can brighten the screen in the OSD menu.
	<b>Photo</b>	Optimizes the screen for photos.
	<b>Cinema</b>	Optimizes the screen for video.
	<b>Custom</b>	You can customize Screen functions.
<b>Game Mode</b>	<b>Gamer 1, 2, 3</b>	Brightness, Contrast, Sharpness, Gamma, Color Temp, Black Stabilizer, Response Time, DAS Mode, and Motion 240 functions can be customized as Gamer 1, 2, or 3.
	<b>FPS 1</b>	Game Mode functions are optimized for FPS games.
	<b>FPS 2</b>	The Black Stabilizer value is greater than that of FPS 1. It is suitable for very dark FPS games.
	<b>RTS</b>	Game Mode functions are optimized for RTS games.
<div style="border: 1px solid black; padding: 10px;"> <p><b>NOTE</b></p> <ul style="list-style-type: none"> <li>Use the GAME MODE button on the front of the monitor to quickly select and switch between the Gamer 1/2/3, FPS 1/2, RTS, and Off options.</li> </ul> </div>		

\* FPS: First-Person Shooter  
 \* RTS: Real-Time Strategy  
 \* DAS: Dynamic Action Sync



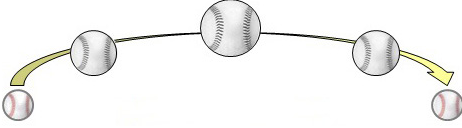
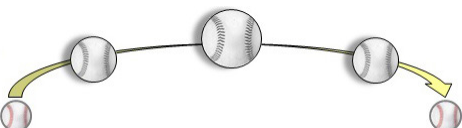





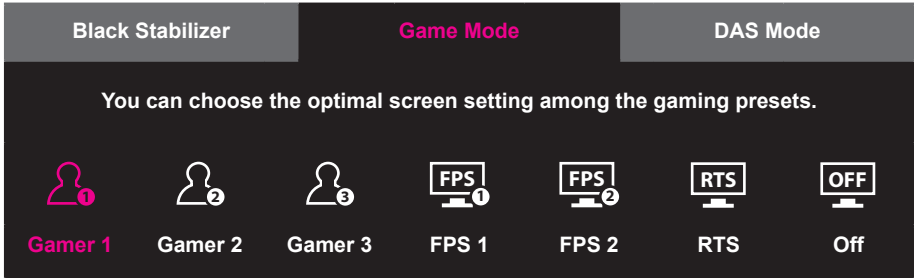
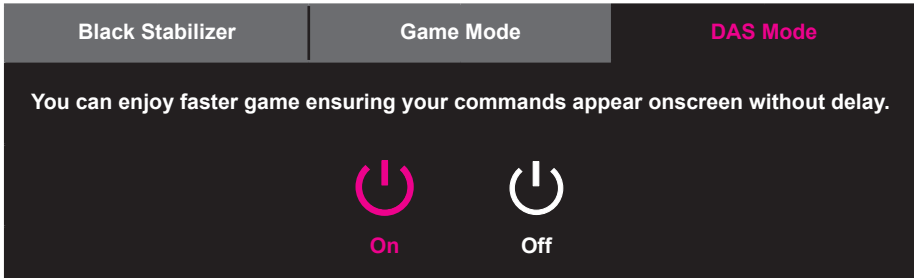

Menu > Function	Description	
<b>DAS Mode</b>	<b>On</b>	You can enjoy faster game ensuring your commands appear onscreen without delay. (The screen flickers when turning DAS Mode on/off.)
	<b>Off</b>	Turns DAS Mode off.
<div style="border: 1px solid black; padding: 10px;"> <p><b>!</b> <b>NOTE</b></p> <ul style="list-style-type: none"> <li>Use the DAS MODE button on the front of the monitor to quickly select and switch between the options.</li> </ul> </div>		
<b>Motion 240</b>	<b>On</b>	<p>This mode minimizes motion blur in fast-moving videos. This function only works for frame rates (vertical frequency) of 100 Hz and 120 Hz. To take full advantage of this function, select 1920 × 1080 @ 120 Hz for DisplayPort (DP) or DVI inputs before enabling Motion 240.</p>  <p><b>This function is available for 100 Hz and 120 Hz only.</b></p>
	<b>Off</b>	<p>Turns Motion 240 Mode off.</p> 
<div style="border: 1px solid black; padding: 10px;"> <p><b>!</b> <b>NOTE</b></p> <ul style="list-style-type: none"> <li>To reduce motion blur, brightness is reduced with backlight control.</li> <li>Motion 240 and DAS Mode cannot be used simultaneously. When Motion 240 is enabled, DAS Mode is disabled automatically.</li> </ul> </div>		
<b>SUPER ENERGY SAVING</b>	Conserve energy by using luminance compensation algorithm	
	<b>High</b>	Saves energy using the high-efficiency SUPER ENERGY SAVING feature.
	<b>Low</b>	Saves energy using the low-efficiency SUPER ENERGY SAVING feature.
	<b>Off</b>	Disables the SUPER ENERGY SAVING function.
<div style="border: 1px solid black; padding: 10px;"> <p><b>!</b> <b>NOTE</b></p> <ul style="list-style-type: none"> <li>If you set the SUPER ENERGY SAVING function to high or low in the picture mode of Reader 1, Reader 2, Photo, or Cinema, the picture mode will be changed to Custom.</li> </ul> </div>		

**!** **NOTE**

- Saving Data depends on the panel. So, those values should be different from each panel and panel vendor. If option of SUPER ENERGY SAVING is High or Low, monitor luminance become higher or lower depend upon source.

**Using Hot Keys**

Use the button on the front of the monitor to quickly select and switch between available options.

Menu	Description								
<p><b>GAME MODE</b></p>	<p>You can enter the OSD menu by pressing the GAME MODE button on the front of the monitor. You can change the Game Mode settings by using the left and right(&lt; &gt;) buttons. Press the GAME MODE button again to save your settings and exit the OSD menu.</p> <div style="background-color: #333; color: white; padding: 10px; text-align: center;"> <p>Black Stabilizer      <b>Game Mode</b>      DAS Mode</p> <p>You can choose the optimal screen setting among the gaming presets.</p> <div style="display: flex; justify-content: space-around; align-items: center;"> <div style="text-align: center;"> <b>Gamer 1</b></div> <div style="text-align: center;"> <b>Gamer 2</b></div> <div style="text-align: center;"> <b>Gamer 3</b></div> <div style="text-align: center;"> <b>FPS 1</b></div> <div style="text-align: center;"> <b>FPS 2</b></div> <div style="text-align: center;"> <b>RTS</b></div> <div style="text-align: center;"> <b>Off</b></div> </div> </div> <table border="1" style="width: 100%; border-collapse: collapse;"> <tr> <td style="width: 20%;"><b>Gamer 1, 2, 3</b></td> <td>To change the detailed settings, go to Menu → Function → Game Mode → Gamer 1,2,3.</td> </tr> <tr> <td><b>FPS 1</b></td> <td>Game Mode functions are optimized for FPS games.</td> </tr> <tr> <td><b>FPS 2</b></td> <td>The Black Stabilizer value is greater than that of FPS 1. It is suitable for very dark FPS games.</td> </tr> <tr> <td><b>RTS</b></td> <td>Game Mode functions are optimized for RTS games.</td> </tr> </table>	<b>Gamer 1, 2, 3</b>	To change the detailed settings, go to Menu → Function → Game Mode → Gamer 1,2,3.	<b>FPS 1</b>	Game Mode functions are optimized for FPS games.	<b>FPS 2</b>	The Black Stabilizer value is greater than that of FPS 1. It is suitable for very dark FPS games.	<b>RTS</b>	Game Mode functions are optimized for RTS games.
<b>Gamer 1, 2, 3</b>	To change the detailed settings, go to Menu → Function → Game Mode → Gamer 1,2,3.								
<b>FPS 1</b>	Game Mode functions are optimized for FPS games.								
<b>FPS 2</b>	The Black Stabilizer value is greater than that of FPS 1. It is suitable for very dark FPS games.								
<b>RTS</b>	Game Mode functions are optimized for RTS games.								
<p><b>DAS MODE</b></p>	<p>You can enter the OSD menu by pressing the DAS MODE button on the front of the monitor. You can change the DAS MODE settings by using the left and right(&lt; &gt;) buttons. Press the DAS MODE button again to save your settings and exit the OSD menu.</p> <div style="background-color: #333; color: white; padding: 10px; text-align: center;"> <p>Black Stabilizer      Game Mode      <b>DAS Mode</b></p> <p>You can enjoy faster game ensuring your commands appear onscreen without delay.</p> <div style="display: flex; justify-content: center; align-items: center; gap: 20px;"> <div style="text-align: center;"> <b>On</b></div> <div style="text-align: center;"> <b>Off</b></div> </div> </div> <table border="1" style="width: 100%; border-collapse: collapse;"> <tr> <td style="width: 20%;"><b>On</b></td> <td>You can enjoy faster game ensuring your commands appear onscreen without delay. (The screen flickers when turning DAS Mode on/off.)</td> </tr> <tr> <td><b>Off</b></td> <td>Turns DAS Mode off.</td> </tr> </table>	<b>On</b>	You can enjoy faster game ensuring your commands appear onscreen without delay. (The screen flickers when turning DAS Mode on/off.)	<b>Off</b>	Turns DAS Mode off.				
<b>On</b>	You can enjoy faster game ensuring your commands appear onscreen without delay. (The screen flickers when turning DAS Mode on/off.)								
<b>Off</b>	Turns DAS Mode off.								

**NOTE**

- The buttons on the front of the monitor are disabled in the sleep mode.

## Picture

- 1 To view the **OSD menu**, press the **joystick button** on the bottom of the monitor and then enter the **Menu**.
- 2 Go to **Screen > Picture** by moving the joystick.
- 3 Configure the options following the instructions that appear in the bottom right corner.
- 4 If you want to configure an upper menu, or another option, move the joystick ◀ or press it (⊙ / OK).
- 5 If you want to exit the OSD menu, move the joystick ◀ until you exit.

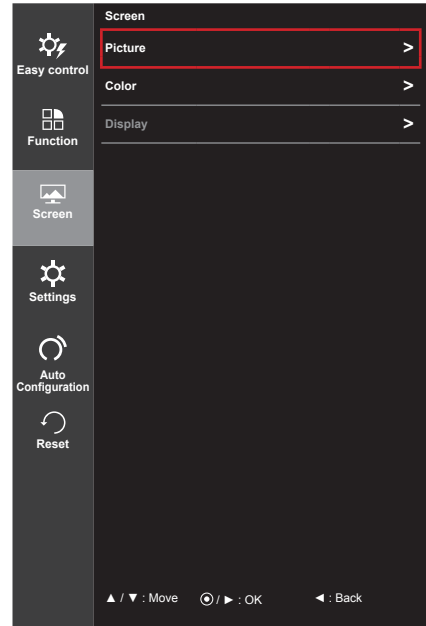

Each option is described below.

Menu > Screen > Picture	Description				
<b>SUPER RESOLUTION+</b>	<p>With the picture improvement technology that minimizes the degradation of the picture quality due to enlargement (e.g. blurred focus or unsharpened edges), the resolution is not compromised, even when the images are enlarged, which guarantees a clear image.</p> <p><b>NOTE</b></p> <ul style="list-style-type: none"> <li>Because this is a function to increase the sharpness of low resolution pictures, it is not recommended to use the function for normal text or for desktop icons. Doing so may result in unnecessarily high sharpness.</li> </ul>				
<b>Sharpness</b>	Adjusts the sharpness of the screen.				
<b>Black Level</b>	<p>Sets the offset level (for HDMI only).</p> <ul style="list-style-type: none"> <li><b>Offset:</b> as a reference for the video signal, this is the darkest color the monitor can display.</li> </ul> <table border="1" style="width: 100%;"> <tr> <td><b>High</b></td> <td>The screen picture gets brighter.</td> </tr> <tr> <td><b>Low</b></td> <td>The screen picture gets darker.</td> </tr> </table>	<b>High</b>	The screen picture gets brighter.	<b>Low</b>	The screen picture gets darker.
<b>High</b>	The screen picture gets brighter.				
<b>Low</b>	The screen picture gets darker.				
<b>Black Stabilizer</b>	<p><b>Black Stabilizer</b> : You can control the black contrast to have better visibility in dark scenes. Increasing the Black Stabilizer value brightens the low gray level area on the screen. (You can easily distinguish objects on dark game screens.) Reducing the Black Stabilizer value darkens the low gray level area and increases the dynamic contrast on the screen.</p> <p><b>NOTE</b></p> <ul style="list-style-type: none"> <li>Use the BLACK ST. button on the front of the monitor to quickly switch between the Black Stabilizer options.</li> </ul>				

Menu > Screen > Picture	Description
<b>Response Time</b>	Sets a response time for displayed pictures based on the speed of the screen. For a normal environment, it is recommended that you use Middle. For a fast-moving picture, it is recommended that you use High. Setting the response time to High may cause image sticking.
	<b>High</b> Sets the response time to High.
	<b>Middle</b> Sets the response time to Middle.
	<b>Low</b> Sets the response time to Low.
	<b>Off</b> Does not use the response time improvement feature.

**Using Hot Keys**

Use the button on the front of the monitor to quickly switch between the BLACK ST. options.

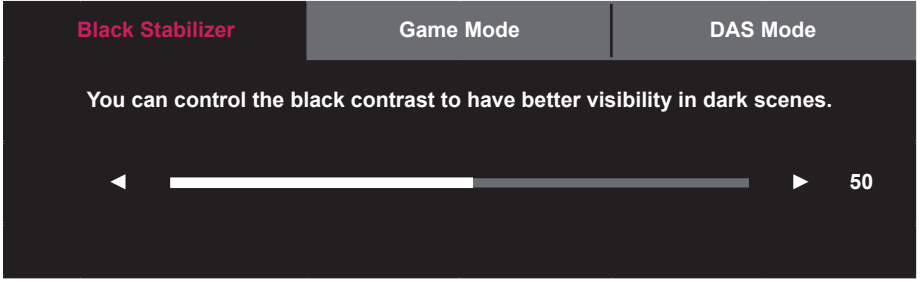
Menu	Description
<b>BLACK ST.</b>	<p>You can enter the OSD menu by pressing the BLACK ST. button on the front of the monitor. You can change the Black Stabilizer settings by using the left and right(&lt; &gt;) buttons. Press the BLACK ST. button again to save your settings and exit the OSD menu.</p> <ul style="list-style-type: none"> <li>-Increasing the Black Stabilizer value brightens the low gray level area on the screen. (You can easily distinguish objects on dark game screens.)</li> <li>- Reducing the Black Stabilizer value darkens the low gray level area and increases the dynamic contrast on the screen.</li> </ul> 

**NOTE**

- The buttons on the front of the monitor are disabled in the sleep mode.

## Color

- 1 To view the **OSD menu**, press the **joystick button** on the bottom of the monitor and then enter the **Menu**.
- 2 Go to **Screen > Color** by moving the joystick.
- 3 Configure the options following the instructions that appear in the bottom right corner.
- 4 If you want to configure an upper menu, or another option, move the joystick ◀ or press it (⊙ / OK).
- 5 If you want to exit the OSD menu, move the joystick ◀ until you exit.

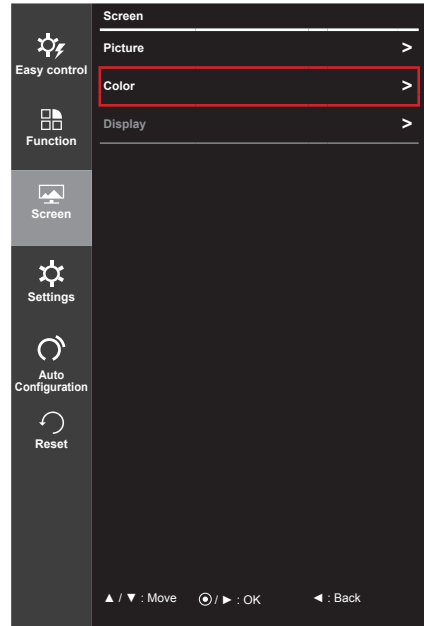

Each option is described below.

Menu > Screen > Color	Description	
<b>Gamma</b>	Custom gamma settings: When using the Gamma 0, Gamma 1, and Gamma 2 monitor settings, higher gamma settings mean a brighter image is displayed and vice versa.	
<b>Color Temp</b>	<b>Warm</b>	Sets the screen color to a reddish tone.
	<b>Medium</b>	Sets the screen color between the reddish and bluish tone.
	<b>Cool</b>	Sets the screen color to a bluish tone.
	<b>Custom</b>	Selects the factory default picture color.
<b>Red</b>	You can customize the picture color using Red, Green, and Blue colors.	
<b>Green</b>		
<b>Blue</b>		
<b>Six Color</b>	Meets the user's requirements for color by adjusting the hue and saturation of the six colors (red, green, blue, cyan, magenta, and yellow) and then saving the settings.	
	<b>Hue</b>	Adjusts the tone of the screen colors.
	<b>Saturation</b>	Adjusts the saturation of the screen colors. The lower the value, the less saturated and brighter the colors become. The higher the value, the more saturated and darker the colors become.
<b>Reset</b>	Returns the colors to the default settings.	

## Display

- 1 To view the **OSD menu**, press the **joystick button** on the bottom of the monitor and then enter the **Menu**.
- 2 Go to **Screen > Display** by moving the joystick.
- 3 Configure the options following the instructions that appear in the bottom right corner.
- 4 If you want to configure an upper menu, or another option, move the joystick ◀ or press it (⊙ / OK).
- 5 If you want to exit the OSD menu, move the joystick ◀ until you exit.

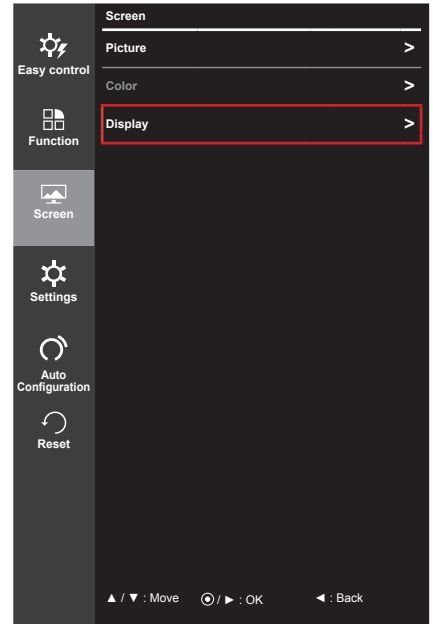

Each option is described below.

Menu > Screen > Display	Description
<b>Horizontal</b>	Used to adjust the horizontal position of the screen.
<b>Vertical</b>	Used to adjust the vertical position of the screen.
<b>Clock</b>	To obtain the correct width of the input signal by adjusting the frequency. Used to minimize the vertical bars that appear because of an incorrect width.
<b>Phase</b>	Used to optimize screen performance by adjusting the phase.

### ! NOTE

- This function is activated only when using D-Sub analog input. (When using analog signals, this function is required because the position and focus of the video varies slightly according to graphic cards, cables, resolution settings, etc. This function is not required when using digital signals.)
- Use the Menu > Auto Configuration (⊙) function to automatically obtain the optimal position and focus.

## Settings

- 1 To view the **OSD menu**, press the **joystick button** on the bottom of the monitor and then enter the **Menu**.
- 2 Go to **Settings** by moving the joystick.
- 3 Configure the options following the instructions that appear in the bottom right corner.
- 4 If you want to configure an upper menu, or another option, move the joystick ◀ or press it (⊙ / OK).
- 5 If you want to exit the OSD menu, move the joystick ◀ until you exit.

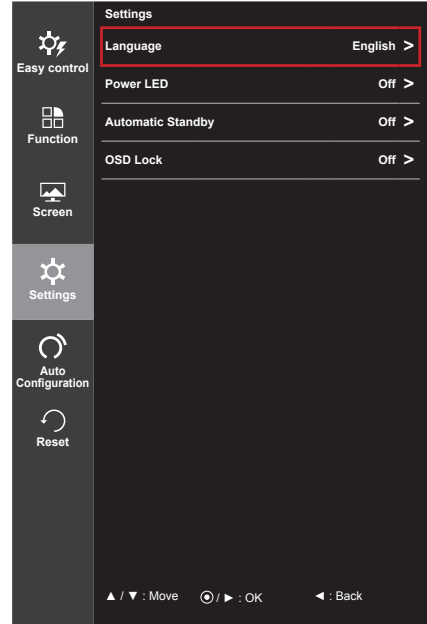

Each option is described below.

Menu > Settings	Description	
<b>Language</b>	Sets the menu screen to the desired language.	
<b>Power LED</b>	Turns the Power LED on the front of the monitor on or off.	
	<b>On</b>	The power LED turns on automatically.
	<b>Off</b>	The power LED turns off.
<b>Automatic Standby</b>	Turns the monitor off automatically when there is no movement on the screen for a set period of time. You can set timer for the auto-off function. (Off, 4H, 6H, and 8H)	
<b>OSD Lock</b>	Prevents incorrect key input.	
	<b>On</b>	Disables the key input feature.
	<b>Off</b>	Enables the key input feature.
<div style="border: 1px solid black; padding: 10px;"> <p><b>NOTE</b></p> <ul style="list-style-type: none"> <li>All of the features are disabled, except for Brightness, Contrast, Volume, Input, OSD Lock in Settings, and the Exit button.</li> </ul> </div>		

## Auto Configuration

- 1 To view the **OSD menu**, press the **joystick button** on the bottom of the monitor and then enter the **Menu**.
- 2 Go to **Auto Configuration** by moving the joystick.
- 3 Configure the options following the instructions that appear in the bottom right corner.
- 4 If you want to configure an upper menu, or another option, move the joystick ◀ or press it (● / OK).
- 5 If you want to exit the OSD menu, move the joystick ◀ until you exit.

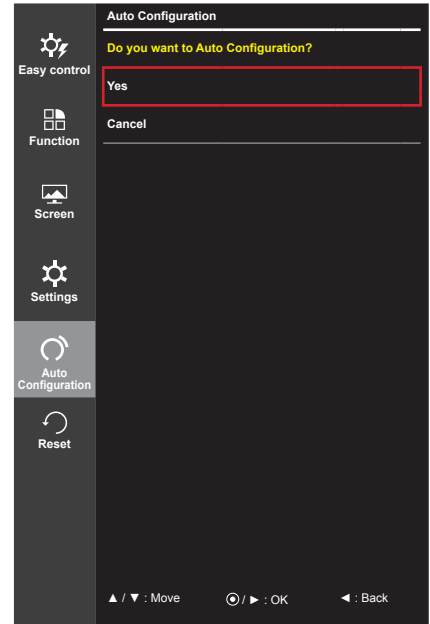

Each option is described below.

Menu > Auto Configuration	Description
<b>Do you want to Auto Configuration?</b>	
<b>Yes</b>	Adjusts the Position, Width, and Phase of the screen automatically. (Activated only when using a D-Sub Analog input.)
<b>Cancel</b>	Cancels the Auto Configuration.



## Reset

- 1 To view the **OSD menu**, press the **joystick button** on the bottom of the monitor and then enter the **Menu**.
- 2 Go to **Reset** by moving the joystick.
- 3 Configure the options following the instructions that appear in the bottom right corner.
- 4 If you want to configure an upper menu, or another option, move the joystick ◀ or press it (⊙ / OK).
- 5 If you want to exit the OSD menu, move the joystick ◀ until you exit.

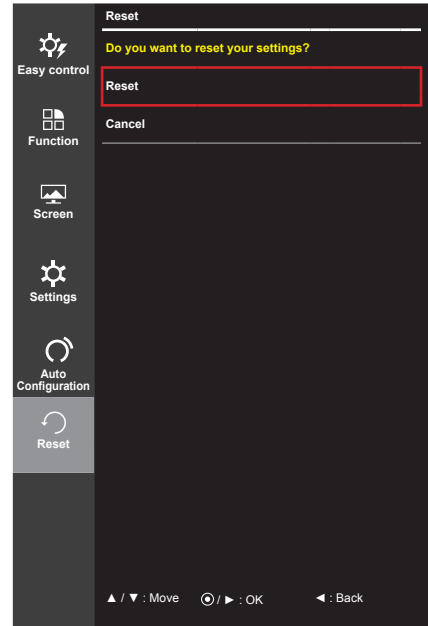

Each option is described below.

Menu > Reset	Description
<b>Do you want to reset your settings?</b>	
<b>Reset</b>	Restores the default settings.
<b>Cancel</b>	Cancels the Reset.

# TROUBLESHOOTING

Nothing is displayed on the screen.	
Is the monitor's power cord plugged in?	<ul style="list-style-type: none"> <li>• Check if the power cord is correctly plugged in to the power outlet.</li> <li>• Confirm there is power available at the AC plug by plugging in a lamp or another electrical device.</li> </ul>
Is the power LED on?	<ul style="list-style-type: none"> <li>• Check the power cable connection and press the power button.</li> </ul>
Is the power on and the power LED displaying white?	<ul style="list-style-type: none"> <li>• Check that the connected input is enabled (Menu - Input).</li> </ul>
Is the power LED blinking?	<ul style="list-style-type: none"> <li>• If the monitor is in sleep mode, move the mouse or press any key on the keyboard to switch the display on.</li> <li>• Check if the computer is turned on.</li> </ul>
Is the <b>OUT OF RANGE</b> message being displayed?	<ul style="list-style-type: none"> <li>• This occurs when signals transferred from the PC (video card) are out of the horizontal or vertical frequency range of the monitor. Please see the <b>Product Specification</b> section of this manual to set the appropriate frequency.</li> </ul>
Is the <b>No Signal</b> message being displayed?	<ul style="list-style-type: none"> <li>• This is displayed when the signal cable between the PC and the monitor is missing or disconnected. Check the cable and reconnect.</li> </ul>

The OSD Lock message is being displayed.	
Are some functions not available when you press the Menu button?	<ul style="list-style-type: none"> <li>• The OSD is locked. Go to <b>Menu &gt; Settings</b> and set <b>OSD Lock</b> to <b>Off</b>.</li> </ul>

The screen retains an image.	
Does image sticking occur even when the monitor is turned off?	<ul style="list-style-type: none"> <li>• Displaying a still image for a prolonged time may cause damage to the screen, resulting in the retention of the image.</li> <li>• To extend the lifetime of the monitor, use a screensaver.</li> </ul>

Screen display is unstable and shaky / Images displayed on the monitor leave shadow trails.	
Did you select the appropriate resolution?	<ul style="list-style-type: none"> <li>• If the selected resolution is HDMI 1080i 60/50 Hz (interlaced), the screen may be flickering. Change the resolution to 1080P or the recommended resolution.</li> </ul>

## NOTE

- **Vertical Frequency:** In order to display an image, the screen must be refreshed dozens of times per second like a fluorescent lamp. The number of times the screen is refreshed per second is called vertical frequency or refresh rate and is represented by Hz.
- **Horizontal Frequency:** The time it takes to display one horizontal line is called the horizontal cycle. The number of horizontal lines displayed in one second can be calculated by dividing one by the horizontal cycle. This is called horizontal frequency and is represented by kHz.

**NOTE**

- Check if the video card's resolution or frequency is within the range allowed by the monitor and set to the recommended (optimal) resolution in **Control Panel > Display > Settings**.
- Failing to set the video card to the recommended (optimal) resolution may result in blurred text, a dimmed screen, a truncated display area or misalignment of the display.
- The configuration procedure may differ depending on your computer and/or operating system. Also, some video cards may not support certain resolutions. If this is the case, contact the manufacturer of the computer or video card for assistance.
- Some video cards may not support 1920 x 1080 resolution.  
If the resolution cannot be displayed, contact the manufacturer of your video card.

**The display color is abnormal.**

Does the display appear discolored (16 color)?	<ul style="list-style-type: none"> <li>• Set the color to 24 bit (true color) or higher. In Windows, go to Control Panel &gt; Display &gt; Settings &gt; Color Quality.</li> </ul>
Does the display color appear unstable or in monochrome?	<ul style="list-style-type: none"> <li>• Check if the signal cable is connected properly. Reconnect the cable or reinsert the PC's video card.</li> </ul>
Are there spots on the screen?	<ul style="list-style-type: none"> <li>• When using the monitor, pixilated spots (red, green, blue, white, or black) may appear on the screen. This is normal for the LCD screen. It is not an error nor is it related to the monitor's performance.</li> </ul>

**No sound from the headphone port.**

Are the D-Sub and DVI connected?	<ul style="list-style-type: none"> <li>• D-Sub and DVI do not support audio.</li> <li>• Audio may not be supported, depending on the type of cable you use.</li> </ul>
Are images displayed using DP (DisplayPort) or HDMI input without sound?	<ul style="list-style-type: none"> <li>• Make sure that the headphone port connections are made properly.</li> <li>• Try increasing the volume with the joystick.</li> <li>• Set the audio output of the PC to the monitor you are using: On Microsoft Windows, go to Control Panel &gt; Hardware and Sound &gt; Sound &gt; set the monitor as default device.</li> </ul>

# PRODUCT SPECIFICATION

LCD Screen	Type	60.9 cm TFT (Thin Film Transistor) LCD (Liquid Crystal Display) Screen Diagonal length of the screen: 60.9 cm 24" class (24" / 60.9 cm diagonal)	
	Pixel Pitch	0.27675 mm x 0.27675 mm	
Resolution	Maximum Resolution	Analog, HDMI	1920 x 1080 @ 60 Hz
		DVI-D, DisplayPort	1920 x 1080 @ 144 Hz
	Recommended Resolution	1920 x 1080 @ 60 Hz	
Video Signal	Horizontal Frequency	Analog, HDMI	30 kHz to 135 kHz
		DVI-D, DisplayPort	30 kHz to 160 kHz
	Vertical Frequency	Analog, HDMI	56 Hz to 120 Hz
		DVI-D, DisplayPort	56 Hz to 144 Hz
Synchronization	Separate Sync.		
Input Connector	USB 1, 2, USB UP, DP(DisplayPort) IN, D-SUB IN, DVI-D IN, HDMI IN 1, 2, HP OUT		
Power	Voltage	AC 100-240 V~ 50 / 60 Hz 0.8 A	
	Power consumption (Typ.)	On Mode ≤ 23 W Sleep Mode ≤ 1.2 W Off Mode ≤ 0.3 W	
Stand Angle	Forward/Backward: -5° to 20° (Head)		
Environmental Conditions	Operating Condition	Temperature: 10°C to 35°C; Humidity: 10% to 80%	
	Storing Condition	Temperature: -20°C to 60°C; Humidity: 5% to 90%	
Dimension	Monitor Size (Width x Height x Depth)		
	With stand	567.6 mm x 401.2 mm x 248 mm (22.3 inch x 15.7 inch x 9.7 inch)	
	Without Stand	567.6 mm x 353.9 mm x 57.3 mm (22.3 inch x 13.9 inch x 2.2 inch)	
Weight (Without Packaging)	With stand	5.43 kg (11.9 lb)	
	Without Stand	3.83 kg (8.4 lb)	

The specifications are subject to change without notice.

## Factory Support Mode (Preset Mode, DisplayPort/D-SUB/DVI-D/HDMI PC)

Preset Mode, PC	Horizontal Frequency (kHz)	Vertical Frequency (Hz)	Polarity (H/V)	Remarks
720 x 400	31.468	70.08	-/+	
640 x 480	31.469	59.94	-/-	
640 x 480	37.5	75	-/-	
800 x 600	37.879	60.317	+/+	
800 x 600	46.875	75	+/+	
800 x 600	76.302	119.972	+/-	
1024 x 768	48.363	60	-/-	
1024 x 768	60.123	75.029	+/+	
1024 x 768	97.551	119.989	+/-	
1280 x 1024	63.981	60.02	+/+	
1280 x 1024	79.976	75.025	+/+	
1280 x 1024 *	130.035	119.958	+/-	
1920 x 1080	67.5	60	+/-	
1920 x 1080 **	137.26	119.98	+/-	
1920 x 1080 **	158.11	144	+/-	

\* 1280 x 1024 @ 120 Hz: HDMI not supported.

\*\* 1920 x 1080 @ 120 Hz/144 Hz: HDMI/D-Sub not supported.

## HDMI Timing (Video)

Preset Mode, PC	Horizontal Frequency (kHz)	Vertical Frequency (Hz)	Remarks
480P	31.5	60	
720P	45	60	
1080P	67.5	60	

## Power LED

Mode	LED Color
On Mode	White
Sleep Mode	Blinking in white
Off Mode	Off

# PROPER POSTURE

## Proper Posture for Using the Monitor

Adjust the screen so that you can comfortably look at it at a slight downward angle from your natural eye level.

- Take a break for approximately 10 minutes every hour to reduce any fatigue caused by long-time usage.
- The stand of the touch monitor allows the product to be used in the optimum position. Adjust the stand angle from  $-5^{\circ}$  to  $20^{\circ}$  to obtain the best view of the screen.

You should be looking slightly down at the screen.

Adjust the angle  $-5^{\circ}$  to  $20^{\circ}$

So that there is no reflection or glare from the screen.

Place your hands gently on the keyboard, keeping your arms bent at the elbows and extended horizontally in front of you.

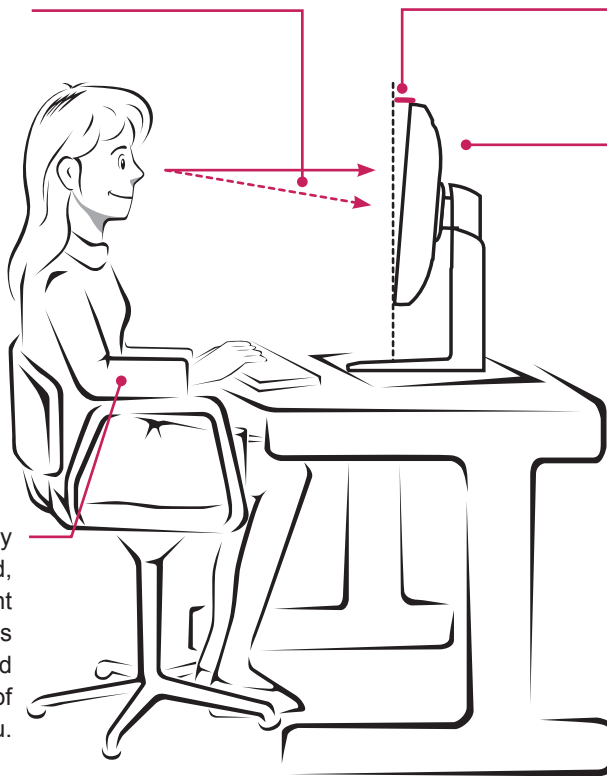





### Declaration of Conformity

Trade Name: LG  
Model: 24GM77  
Responsible Party: LG Electronics Inc.  
Address: 1000 Sylvan Ave.  
Englewood Cliffs NJ 07632  
U.S.A  
TEL: 201-266-2534

This device meets the EMC requirements for home appliances (Class B) and is intended for home usage. This device can be used in all regions. Read the owner's manual (CD) carefully and keep it at hand. Please note that the label attached to the product provides information for technical support.

Model \_\_\_\_\_  
Serial No. \_\_\_\_\_

ENERGY STAR is a set of power-saving guidelines issued by the U.S.Environmental Protection Agency(EPA).



As an ENERGY STAR Partner LGE U. S. A., Inc. has determined that this product meets the ENERGY STAR guidelines for energy efficiency.

Refer to ENERGY STAR.gov for more information on the ENERGY STAR program.