



ENGLISH

OWNER'S MANUAL

# High Power A/V Receiver with Giant Tallboy Speaker System

Please read this manual carefully before operating your set and retain it for future reference.

ARX9 (ARX9, S94P2-F)



MFL68085496

[www.lg.com](http://www.lg.com)

## Safety information



**CAUTION:** TO REDUCE THE RISK OF ELECTRIC SHOCK DO NOT REMOVE COVER (OR BACK) NO USER-SERVICEABLE PARTS INSIDE REFER SERVICING TO QUALIFIED SERVICE PERSONNEL.

This lightning flash with arrowhead symbol within an equilateral triangle is intended to alert the user to the presence of uninsulated dangerous voltage within the product's enclosure that may be of sufficient magnitude to constitute a risk of electric shock to persons.



The exclamation point within an equilateral triangle is intended to alert the user to the presence of important operating and maintenance (servicing) instructions in the literature accompanying the product.



**WARNING:** TO PREVENT FIRE OR ELECTRIC SHOCK HAZARD, DO NOT EXPOSE THIS PRODUCT TO RAIN OR MOISTURE.

**WARNING:** Do not install this equipment in a confined space such as a book case or similar unit.

**CAUTION:** The apparatus should not be exposed to water (dripping or splashing) and no objects filled with liquids, such as vases, shall be placed on the apparatus.

**CAUTION:** Do not block any ventilation openings. Install in accordance with the manufacturer's instructions.

Slots and openings in the cabinet are provided for ventilation and to ensure reliable operation of the product and to protect it from over heating. The openings shall never be blocked by placing the product on a bed, sofa, rug or other similar surface. This product should not be placed in a built-in installation such as a bookcase or rack unless proper ventilation is provided or the manufacturer's instruction has been adhered to.

### CAUTION concerning the Power Cord

Most appliances recommend they be placed upon a dedicated circuit;

That is, a single outlet circuit which powers only that appliance and has no additional outlets or branch circuits. Check the specification page of this owner's manual to be certain. Do not overload wall outlets. Overloaded wall outlets, loose or damaged wall outlets, extension cords, frayed power cords, or damaged or cracked wire insulation are dangerous. Any of these conditions could result in electric shock or fire. Periodically examine the cord of your appliance, and if its appearance indicates damage or deterioration, unplug it, discontinue use of the appliance, and have the cord replaced with an exact replacement part by an authorized service center. Protect the power cord from physical or mechanical abuse, such as being twisted, kinked, pinched, closed in a door, or walked upon. Pay particular attention to plugs, wall outlets, and the point where the cord exits the appliance. To disconnect power from the mains, pull out the mains cord plug. When installing the product, ensure that the plug is easily accessible.

This device is equipped with a portable battery or accumulator.

**Safety way to remove the battery or the battery from the equipment:** Remove the old battery or battery pack, follow the steps in reverse order than the assembly. To prevent contamination of the environment and bring on possible threat to human and animal health, the old battery or the battery put it in the appropriate container at designated collection points. Do not dispose of batteries or battery together with other waste. It is recommended that you use local, free reimbursement systems batteries and accumulators. The battery shall not be exposed to excessive heat such as sunshine, fire or the like.

# Table of Contents

## 1 Getting Started

---

- 2 Safety information
- 6 Unique features
- 6 Accessories
- 6 Introduction
  - 6 – Symbols Used in this Manual
- 7 – Required cables
- 8 Remote control
- 10 Front panel
- 11 Rear panel

## 2 Connecting

---

- 12 Before connecting
- 12 Positioning the system
- 13 Connecting to speakers
- 14 Connecting TV with other devices
  - 14 – Using an HDMI cable
  - 16 – Using a composite video cable
- 17 Connecting audio devices
- 18 Connecting other devices
- 19 Connecting the antenna
- 19 Connecting portable devices

## 3 System Setting

---

- 20 Settings and adjustments using the SETUP menu
  - 20 – SETUP configuration
  - 20 – TESTTONE menu
  - 21 – LEVEL menu
  - 21 – DISTANCE menu
  - 22 – A/V SYNC menu (Adjusting the audio delay)
  - 22 – DOLBY DRC menu
  - 22 – RESET menu

## 4 Operating

---

- 23 Selecting the input source
  - 23 – By using the knob on the unit
  - 23 – By using the remote control
- 24 USB Operation
  - 24 – Basic Operations
  - 24 – Selecting a folder and an MP3/WMA file
  - 25 – Deleting an MP3/WMA file
  - 25 – Playing repeatedly or randomly
  - 25 – To activate the mute function
  - 26 – Playable file Requirement
  - 27 – Playback effect
- 30 Enjoying various sound mode
  - 30 – Setting the USER EQ
- 32 Using a Bluetooth wireless technology
  - 32 – Listening to music stored on the Bluetooth devices
    - 34 – Using Bluetooth App
    - 35 – Activate Bluetooth with "LG Bluetooth Remote" App
- 36 Radio Operations
  - 36 – Listening to FM radio
  - 36 – Improving poor FM reception
  - 36 – Presetting the Radio Stations
  - 36 – Deleting all the saved stations
- 37 Other Operations
  - 37 – Dimmer
  - 37 – Using the Sleep Timer
  - 37 – Displaying file and input source
  - 37 – Auto power down
- 38 Advanced Operations
  - 38 – Recording to USB

## 5 Troubleshooting

---

39 Troubleshooting

## 6 Appendix

---

40 Trademarks and licenses

40 Maintenance

40 – Handling the unit

41 Specifications

1

2

3

4

5

6

## Unique features

### Bluetooth

Listens to music stored on your bluetooth device.

### Portable In

Listens to music from your portable device. (MP3, Notebook, etc.)

### Playback effects

Listens to music various sound and playback effects.

### USB Direct Recording

Records music to your USB device. (analog sources only.)

### LG Bluetooth Remote

LG Bluetooth Remote is an App designed to let you take control of some of LG's latest Audio devices. Refer to the page 34-35.

## Accessories

Please check and identify the supplied accessories.

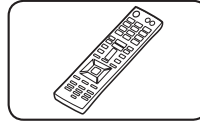

Remote control (1)

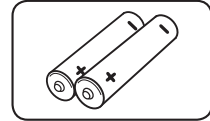

Batteries (2)

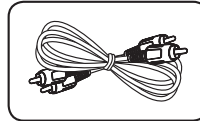

Analog audio cable (1)

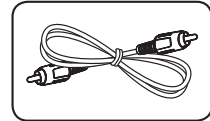

Video cable (1)

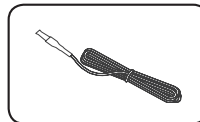

FM antenna (1)

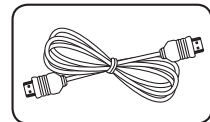

HDMI cable (1)

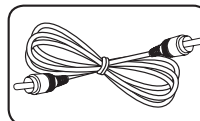

Coaxial cable (1)

## Introduction

### Symbols Used in this Manual

#### ! Note

Indicates special notes and operating features.

#### ! Caution

Indicates cautions for preventing possible damages from abuse.

## Required cables

The hookup diagrams on the subsequent pages assume the use of the following connection cables.

You must purchase the connection cables separately if necessary.

- Analog audio cable



- Composite video cable



- Analog audio/Composite video cable



- Optical digital audio cable



- Coaxial digital audio cable



- HDMI cable



- Portable cable (∅ 3.5 mm Stereo plug)



### ! Note

- Turn off the power to all components before making any connections.
- When connecting an audio/video cable, be sure to match the color-coded pins to the appropriate jacks on the components: yellow (video) to yellow; white (left, audio) to white; and red (right, audio) to red.
- When connecting optical digital cables, insert the cable plugs straight in until they click into place.
- Do not bend or tie optical digital audio cables.

1

Getting Started

# Remote control

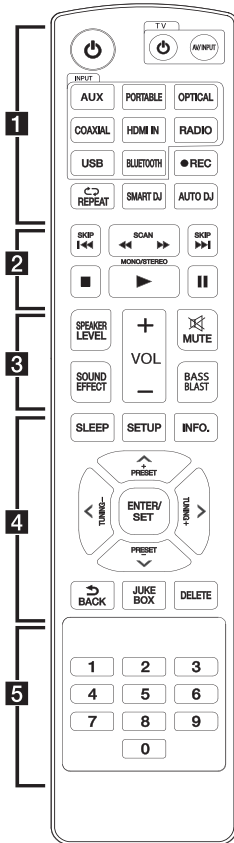

..... **1** .....

⏻ : Switches the unit ON or OFF.

TV control buttons : Controls the TV. (LG TV only)

- ⏻ : Turns the TV on or off.

- **AV/INPUT** : Switches the TV's input source between the TV and other input sources.

INPUT buttons : Selects the input source you want to use. (For more information refer to the page 23.)

- **AUX** : Selects the input source connected to AUX IN 1/2(L/R) jack.

- **PORTABLE** : Selects the input source connected to PORT.IN jack.

- **OPTICAL** : Selects the input source connected to OPTICAL IN 1/2 jack.

- **COAXIAL** : Selects the input source connected to COAXIAL IN jack.

- **HDMI IN** : Selects the input source connected to HDMI IN 1/2/3 jack.

- **RADIO** : Selects the FM tuner.

- **USB** : Selects the input source connected to USB port.

- **BLUETOOTH** : Selects Bluetooth function.

● **REC** : USB direct recording.

**REPEAT**(↺↻) : Listens to your files repeatedly or randomly.

**SMART DJ** : Selects SMART DJ mode. (For more information refer to the page 27.)

**AUTO DJ** : Selects the AUTO DJ mode. (For more information refer to the page 28.)

## Battery Installation

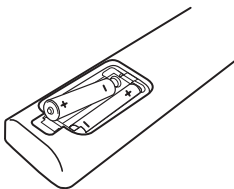

Remove the battery cover on the rear of the Remote Control, and insert two (size AAA) batteries with + and - matched correctly.



2

**⏮/⏭ (SKIP)** : Goes to the next or previous file.

**⏪/⏩ (SCAN)** : Searches backward or forward.

**■ (Stop)** : Stops playback.

**▶/MONO/STEREO (Play)** :

- Starts playback.
- Selects mono/stereo in FM mode.

**⏸ (Pause)** : Pauses playback.

3

**SPEAKER LEVEL** : Sets the sound level of desired speaker.

**SOUND EFFECT** : Selects a sound effect mode.

**VOL (-/+)** : Adjusts speaker volume.

**🔇 MUTE** : Turns off the sound temporarily. Press the button again to restore the sound.

**BASS BLAST** : Selects the BASS BLAST sound mode directly.

4

**SLEEP** : Sets dimmer or the system to turn off automatically at a specified time.

**SETUP** : Displays or exits the [SETUP] menu.

**INFO.** : Displays information. (file name / input source / recording elapsed time)

**ENTER/SET** : Acknowledges menu selection.

**PRESET (-/+)** : Selects a preset stations.

**TUNING (-/+)** : Tunes in the desired radio station.

**^/v/</>** (up/ down/ left/ right): Selects an option in the menu.

**↩ BACK** : Moves backwards in the menu or exits the setup menu.

**JUKE BOX** :

- Selects JUKE BOX mode.
- Makes your favorites list.

**DELETE** :

- Deletes MP3/WMA files.
- Deletes a song on JUKE BOX list.

5

**0 to 9 numerical buttons** : Selects numbered options in a menu.

1

Getting Started

## Front panel

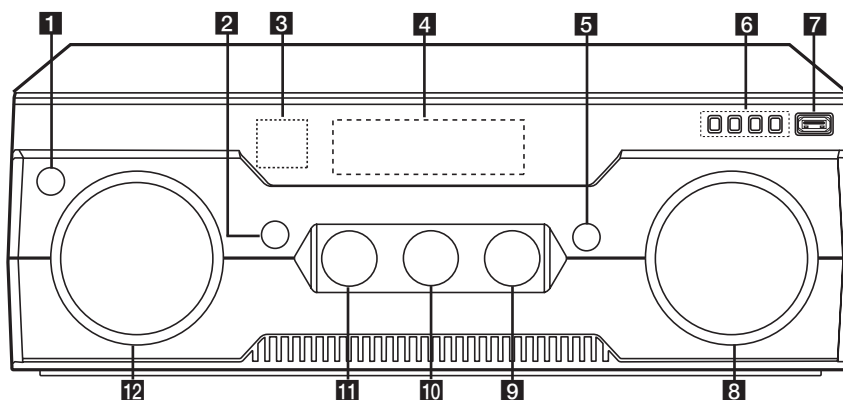

### 1 STANDBY/ON (⏻/⏻)

Switches the unit ON or OFF.

### 2 BASS BLAST

Selects the BASS BLAST sound mode directly.

### 3 Remote sensor

### 4 Display window

Shows the current status of the unit.

### 5 SMART DJ

Selects SMART DJ mode. (For more information refer to the page 27.)

### 6 USER EQ

Sets the USER EQ mode (BASS, MIDDLE and TREBLE). (For more information refer to the page 30.)

### ENTER

- Acknowledges menu selection.
- Enters USER EQ/ Confirms USER EQ setting. (For more information refer to the page 30.)

### PLAY/PAUSE

- Starts playback.
- Pauses playback, press it again to exit pauses status.
- Selects BASS, MIDDLE or TREBLE while in "USER EQ" mode by pressing **PLAY/PAUSE** repeatedly. (For more information refer to the page 30.)

### STOP

Stops playback.

### 7 USB port (5 V --- 500 mA)

Connects an USB device to USB port.

### 8 MASTER VOLUME

Adjusts the speaker volume.

### 9 CONTROL

- Control the DJ EFFECT.
- Adjust USER EQ sound level. (For more information refer to the page 30.)

### 10 DJ EFFECT

- Selects DJ effect. (For more information refer to the page 28.)

### 11 SOUND EFFECT

Selects Sound effect.

### 12 INPUT SELECTION

Selects input source.

## Rear panel

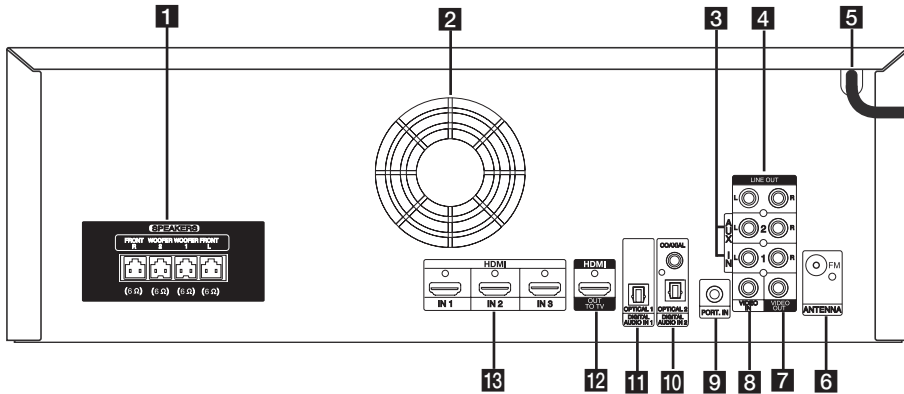

- 1** **Speakers connectors**  
Connects the speaker cables.
- 2** **Cooling fan**
- 3** **AUX IN 1/2 (L/R)**  
Connects to external source with 2 channel audio outputs
- 4** **LINE OUT**  
Connects the components with 2 channel audio inputs.
- 5** **Power cord**
- 6** **ANTENNA**  
FM – Connects the FM wired antenna.
- 7** **VIDEO OUT**  
Connects the components with analog video input jacks.
- 8** **VIDEO IN**  
Connects the components with analog video output jacks.
- 9** **PORT. IN**  
Connects a portable device (MP3 player, etc) to PORT. IN jack.
- 10** **DIGITAL AUDIO IN 2 COAXIAL**  
Connects other components with a coaxial digital audio output.
- 11** **DIGITAL AUDIO IN 1 OPTICAL 1**  
Connects other components with an optical digital audio output.
- 12** **HDMI OUT TO TV**  
Connects to TV with HDMI inputs.
- 13** **HDMI IN 1/2/3**  
Connects the component with HDMI output.

## Before connecting

Please make sure to disconnect the AC power cord before making any connection between the unit and any other device.

## Positioning the system

The following illustration shows an example of positioning the system. Note that the illustrations in these instructions differ from the actual unit for explanation purposes.

For the best possible surround sound, all the speakers should be placed at the same distance from the listening position (A).

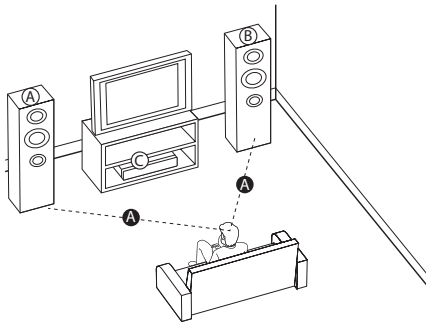

Ⓐ Front speaker with built in subwoofer (L)

Ⓑ Front speaker with built in subwoofer (R)

Place the front speakers to the sides of the monitor or screen and as flush with the screen surface as possible.

Ⓒ Unit

### ⚠ Caution

- Do not stack the speakers and be careful that the speaker should not fall down. Otherwise it may result in the speaker malfunction and causing personal injury and/or property damage.
- Make sure to install the speaker with other people in order to prevent it from falling and causing injuries to the installer.

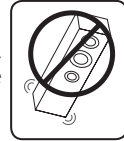

## Connecting to speakers

Connect the speaker cable plugs to the SPEAKERS connector. Make sure to connect the speaker's plug to the corresponding speaker connector when connecting the plug.

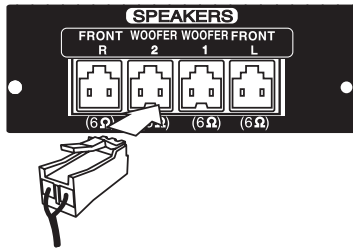

Color	Speaker
Red	FRONT R
Orange	WOOFER 2
Orange	WOOFER 1
White	FRONT L

### ⚠ Caution

- Do not try to lift the speaker alone. It needs two persons to lift the speaker. Otherwise it may result in the speaker malfunction and cause personal injury and/or property damage.
- Check the volume level before playing music to prevent infirm, child, and pregnant women from being shocked by the sudden and loud sound from the unit.
- Do not use the unit in a limited space. It may damage a person's hearing. It is recommended to use it in a wide space.
- Be careful to make sure children not to put their hands or any objects into the opening speaker duct hole.
- The speakers contain magnet parts, so color irregularity may occur on the TV screen or PC monitor screen. Please use the speakers far away from either TV screen or PC monitor.

## Connecting TV with other devices

You can watch the input image from your video device. There are two ways of connecting your video device to AV Receiver System.

### Using an HDMI cable

Since HDMI offers both audio and video signal over one cable, you can enjoy them without additional audio cable.

1. Connect the **HDMI IN 1/2/3** jack on AV Receiver System to your video device with HDMI OUT jack using HDMI cable.
2. Connect the **HDMI OUT TO TV** jack on AV Receiver System to the HDMI IN jack on your TV.
3. Set the input source to HDMI (refer to the page 23).

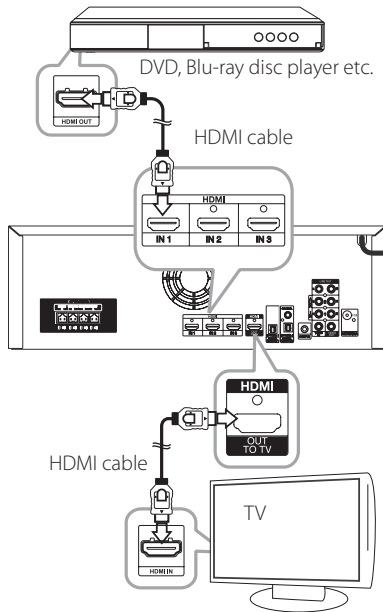

**Note**

- HDMI is the abbreviated name for High Definition Multimedia Interface. It is an interface which transmits video and audio signals in digital format. If a connected HDMI device does not accept the audio output of the unit, the HDMI device's audio sound may be distorted or may not output.
- When you connect a HDMI or DVI compatible device make sure of the followings :
  - Try switching off the HDMI/DVI device and this unit. Next, switch on the HDMI/DVI device and leave it for around 30 seconds, then switch on this unit.
  - The connected device's video input is set correctly for this unit.
  - The connected device is compatible with 720 x 576i (or 480i), 720 x 576p (or 480p), 1280 x 720p, 1920 x 1080i or 1920 x 1080p video input.
  - This unit does not support 4K (Ultra HD) video input normally. So if you play 4k sources, please connect to TV directly.
- Not all HDCP-compatible HDMI or DVI devices will work with this unit.
- The picture will not be displayed properly with non-HDCP device.
- This unit does not playback and TV screen is changed to black screen.
- If there are noises or lines on the screen, please check the HDMI cable (length is generally limited to 4.5 m(15 ft)).
- Changing the resolution when the connection has already been established may result in malfunctions. To solve the problem, turn off the unit and then turn it on again.
- When the HDMI connection with HDCP is not verified, TV screen is changed to black screen. In this case, check the HDMI connection, or disconnect the HDMI cable.
- When DTS source is connected through HDMI IN jacks, the unit converts from DTS source to PCM.

## Using a composite video cable

To enjoy both sounds and pictures from your device, you have to connect analog audio cable as well as composite video cable.

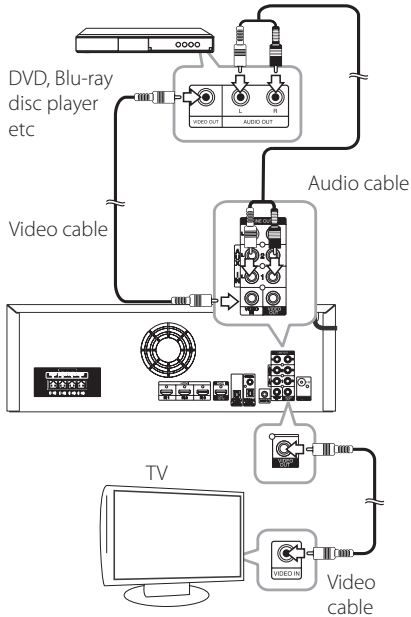

1. Connect the **VIDEO IN** jack on AV Receiver System to the VIDEO OUT jack on your video device using a composite video cable.
2. Connect the **AUX IN 1/2 (L/R)** jacks of AV Receiver System to the left and right AUDIO OUT jacks on your video device using an audio cables.
3. Connect the **VIDEO OUT** jack on your AV Receiver System to the VIDEO IN jack on your TV.
4. Set the input source to AUX1/2 (refer to the page 23).

### ! Note

When connecting an audio/video cable, be sure to match the color-coded pins to the appropriate jacks on the components: yellow (video) to yellow; white (left, audio) to white; and red (right, audio) to red.



## Connecting audio devices

You can hear the sound from your TV, DVD player, Blu-ray player, CD player, etc.

It is not necessary to connect all the cables. Connect AV Receiver System to an AUX, a COAXIAL or an OPTICAL jack on your device you want to connect.

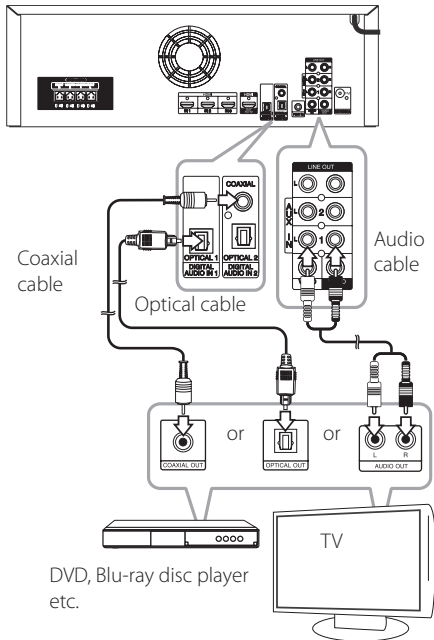

1. Connect **AUX1/2 IN (L/R)**, **COAXIAL** or **OPTICAL 1/2** jack on AV Receiver System to your audio device's OUTPUT jack you want.
2. Set the input source to AUX 1/2, COAXIAL or OPTICAL 1/2 you connect (Refer to the page 23).

### ! Note

- When connecting an audio/video cable, be sure to match the color-coded pins to the appropriate jacks on the components: yellow (video) to yellow; white (left, audio) to white; and red (right, audio) to red.
- When connecting OPTICAL or COAXIAL jack, DTS is not output.

## Connecting other devices

You can connect various devices (TV, recorder, etc) to the jacks on AV receiver system.

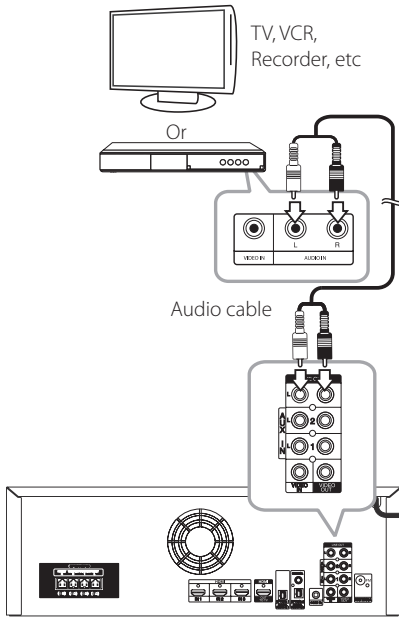

1. Connect the **LINE OUT** jacks on AV Receiver System to your device's INPUT jack you want
2. Set the input source to FM, PORT.IN or AUX1/2 you connect (Refer to the page 23).

Refer to "Connecting audio devices" and "Connecting portable device" when you connect external device.

### ! Note

- When connecting an audio/video cable, be sure to match the color-coded pins to the appropriate jacks on the components: yellow (video) to yellow; white (left, audio) to white; and red (right, audio) to red.
- It is only output analog signal. (FM, portable, or AUX1/2)
- When you connect to a TV by using only audio cable, TV AV setup menu may not be activated (It depends on TV models). But audio will be outputted normally.

## Connecting the antenna

1. Connect the FM wire antenna to the FM antenna connector.

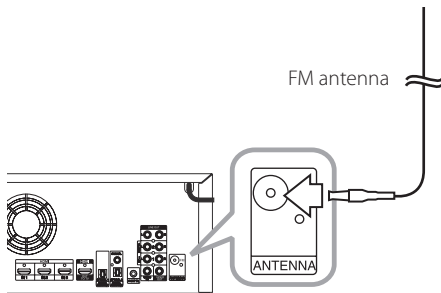

2. Set the input source to FM tune (refer to the page 23).

### ! Note

Be sure to fully extend the FM wire antenna.

## Connecting portable devices

1. Connect the **PORT. IN** jack on the rear panel of AV Receiver System to LINE OUT jack on your portable device (MP3 player, etc.) using a portable cable (∅ 3.5 mm stereo plug).

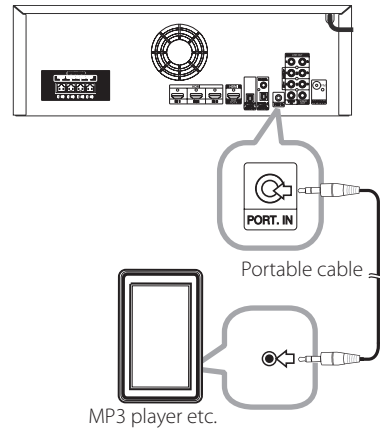

2. Set the input source to PORTABLE (refer to the page 23).

## Settings and adjustments using the SETUP menu

By using the SETUP menus, you can make various adjustments to customize the unit.

### SETUP configuration

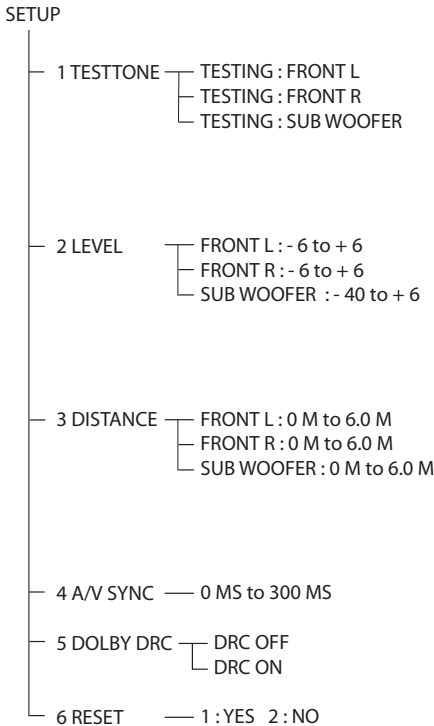

### TESTTONE menu

You can adjust the speaker levels while listening to the test tone from your listening position.

1. Press **SETUP**.  
"1 TESTTONE" appears on the display window.

2. Press **ENTER/SET**.

The test tone is emitted from each speaker in sequence as follows:

TESTING : FRONT L → TESTING : FRONT R →

TESTING : SUB WOOFER

You can select desired speakers manually by pressing **▲/▼** repeatedly

3. You can verify each speakers tone.

4. Press **↶ BACK** to move to the previous menu.  
Press **SETUP** to exit the setup menu.

## LEVEL menu

You can adjust the level of each speaker to suit your preference.

1. Press **SETUP**.  
"1 TESTTONE" appears on the display window.
2. Press **▲/▼** repeatedly until "2 LEVEL" appears, then press **ENTER/SET**.
3. Press **▲/▼** repeatedly until the desired speaker appears.

Display	Description
FRONT L	Front left speaker (- 6 to + 6)
FRONT R	Front right speaker (- 6 to + 6)
SUB WOOFER	Subwoofer (- 40 to + 6)

4. Press **</>** to adjust the level of each speaker.
5. Press **↶ BACK** to move to the previous menu.  
Press **SETUP** to exit the setup menu.

You can adjust speaker level directly by pressing **SPEAKER LEVEL** on the remote control

### Adjusting the speaker levels

You can adjust the level of each speaker. These settings are applied to all sound fields. You can adjust from - 6 to + 6 (Subwoofer - 40 to + 6).

1. Press **SPEAKER LEVEL** on the remote control, and press **▲/▼** repeatedly until the desired speaker appears.  
The display changes cyclically in the display window as follows.  
FRONT L → FRONT R → SUB WOOFER
2. Press **</>** to adjust the level of each speaker.
3. Repeat and adjust the sound level of the other speakers.

## DISTANCE menu

You can set the distance of the speakers connected to this unit.

1. Press **SETUP**.  
"1 TESTTONE" appears on the display window.
2. Press **▲/▼** repeatedly until "3 DISTANCE" appears, then press **ENTER/SET**.
3. Press **▲/▼** repeatedly until the desired speaker appears.

Display	Description
FRONT L	Front left speaker (0 M to 6.0 M)
FRONT R	Front right speaker (0 M to 6.0 M)
SUB WOOFER	Subwoofer (0 M to 6.0 M)

4. Press **</>** to set the distance of the speakers.
5. Press **↶ BACK** to move to the previous menu.  
Press **SETUP** to exit the setup menu.

## A/V SYNC menu (Adjusting the audio delay)

You can delay the sound output using this function when the image is slower than the sound.

1. Press **SETUP**.  
"1 TESTTONE" appears on the display window.
2. Press **▲ / ▼** repeatedly until "4 A/V SYNC" appears, then press **ENTER/SET**.
3. Press **< / >** to adjust the delay between sound and image.  
You can adjust from 0 MS to 300 MS in 10 MS steps.
4. Press **↶ BACK** to move to the previous menu.  
Press **SETUP** to exit the setup menu.

### ! Note

You may not be able to adjust the delay between sound and image perfectly using this function.

## RESET menu

This allows you to initialize settings you have made in the SETUP menu.

1. Press **SETUP**.  
"1 TESTTONE" appears on the display window.
2. Press **▲ / ▼** repeatedly until "6 RESET" appears, then press **ENTER/SET**.  
"1 : YES 2 : NO" appears on the display window.
3. Press the numeric 1 to reset the unit to its original settings.  
If you don't want to reset it, press the numeric 2.
4. Press **↶ BACK** to move to the previous menu.  
Press **SETUP** to exit the setup menu.

## DOLBY DRC menu

This function allows you to listen to a movie at a lower volume without losing clarity of sound. You can compress the dynamic range of the Dolby Digital audio output.

1. Press **SETUP**.  
"1 TESTTONE" appears on the display window.
2. Press **▲ / ▼** repeatedly until "5 DOLBY DRC" appears, then press **ENTER/SET**.
3. Press **< / >** to set the DRC.  
- DOLBY DRC OFF : Deactivates this function.  
- DOLBY DRC ON : Activates this function.
4. Press **↶ BACK** to move to the previous menu.  
Press **SETUP** to exit the setup menu.

### ! Note

Audio dynamic range compression lets you compress the dynamic range of the soundtrack based on the dynamic range information included in the Dolby Digital signal.

## Selecting the input source

This section explains how to select the input source (i.e., the AUX component that you want to listen).

It is necessary to connect the equipment you want to enjoy such as DVD, Blu-ray disc player, USB etc.

### By using the knob on the unit

1. Press **⏻/I (STANDBY/ON)** on the unit.
2. Select a source by using **INPUT SELECTION** on the unit. The selected source appears on the display window.

To select	Display (Function)
Component connected to AUX IN 1 jack	AUX 1
Component connected to AUX IN 2 jack	AUX 2
Portable device connected to PORT. IN jack	PORTABLE
Connect Bluetooth device to unit.	BLUETOOTH
Component connected to HDMI IN 1 jack	HDMI IN 1
Component connected to HDMI IN 2 jack	HDMI IN 2
Component connected to HDMI IN 3 jack	HDMI IN 3
Component connected to OPTICAL IN 1 jack	OPTICAL 1
Component connected to OPTICAL IN 2 jack	OPTICAL 2
Component connected to COAXIAL IN jack	COAXIAL
FM radio	FM
USB device connected to USB port	USB

### By using the remote control

1. Press **⏻** on the remote control.
2. Select a source by pressing the button on the remote control once or repeatedly.

To select	Button
Component connected to AUX 1/2	<b>AUX</b>
Portable device connected to PORT. IN jack	<b>PORTABLE</b>
Component connected to OPTICAL IN 1/2 jack	<b>OPTICAL</b>
Component connected to COAXIAL IN jack	<b>COAXIAL</b>
Component connected to HDMI 1/2/3 jack	<b>HDMI IN</b>
FM radio	<b>RADIO</b>
USB device connected to USB port	<b>USB</b>
Bluetooth device connected to unit.	<b>BLUETOOTH</b>

## USB Operation

### Basic Operations

1. Connect the USB device to the USB port.

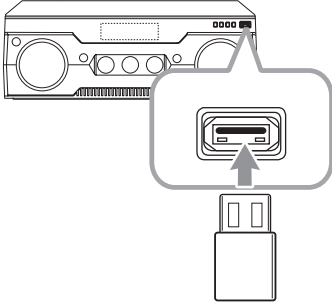

2. Select the USB function by rotating **INPUT SELECTION** on the unit or pressing **USB** on the remote control.

To	Do this
Stop	Press <b>■</b> on the remote control or <b>STOP</b> on the unit.
Playback	Press <b>▶</b> on the remote control or <b>PLAY/PAUSE</b> on the unit.
Pause	Press <b>⏸</b> on the remote control or <b>PLAY/PAUSE</b> on the unit during playback.
Searching for a section within a file	Press <b>◀▶</b> on the remote control during playback and release it at the point you want to listen to.
Selecting a file directly	Press <b>0</b> to <b>9</b> numerical buttons on the remote control to go to the desired file directly.
Skipping to the next/previous file	Press <b>⏮</b> / <b>⏭</b> to go to the next file or to return to the beginning of the current file. Press <b>⏮</b> twice briefly to step back to the previous file.

### Selecting a folder and an MP3/WMA file

1. Press **Λ/V** repeatedly until a desired folder appears.
2. Press **▶** to play it. The first file of folder will play.

#### ! Note

- USB Folders/Files are recognized as below.

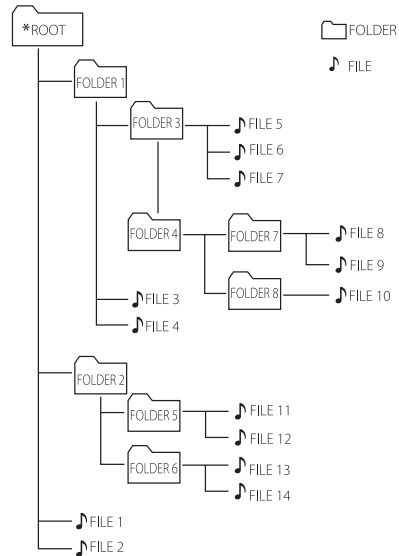

- If there is no file in a folder, the folder will not appear.
- Folders will be presented as the following order;  
ROOT → FOLDER 1 → FOLDER 3 → FOLDER 7 → FOLDER 8 → FOLDER 5 → FOLDER 6
- File will be played from **♪** file No.1 to **♪** file No.14 one by one.
- Files and folders will be presented in order recorded and may be presented differently according to the record circumstances.
- **\*ROOT** : The first screen you can see when a computer recognize the USB is "ROOT".



## Deleting an MP3/WMA file

You can delete file, folder or format by pressing **DELETE**. This function is supported only in stop status. (USB only)

1. -Select the file or folder you want to delete and press **DELETE**.  
-Press and hold **DELETE** to format the USB device.

Or

Press **DELETE** repeatedly during selecting the MP3/WMA file.

The display changes in the following order.

- DEL FILE? : Deletes file
- DEL FOLDER? : Deletes folder
- FORMAT? : Formats USB

2. To delete file/folder or format, press ►.
3. If you want to exit the current mode, press ■



### Caution

- Do not extract the USB device during operation. (play, delete, etc.)
- Regular back up is recommended to prevent data loss.
- The delete function may not be supported according to the USB status. (lock, etc.)

## Playing repeatedly or randomly

During playback, press **REPEAT** repeatedly to select a desired mode.

Display	Description
REPEAT TRK	The current file will be played repeatedly.
REPEAT DIR	All the files in Directory will be played repeatedly.
REPEAT ALL	All the files in device will be played repeatedly.
RANDOM	The files will be played in random order.
Off	Returns to normal playback.

## To activate the mute function

Press **MUTE** on the remote control. "X" appears on the display window.

To cancel, press **MUTE** on the remote control again or change the volume level by using **VOL -/+** on the remote or rotating **MASTER VOLUME** on the front panel.

## Playable file Requirement

### Music file requirement

MP3/WMA file compatibility with this unit is limited as follows.

- Sampling frequency : within 32 to 48 kHz (MP3), within 32 to 48 kHz (WMA)
- Bit rate : within 32 to 320 kbps (MP3), 40 to 192 kbps (WMA)
- Maximum files : Under 999
- Maximum folders : Under 99
- File extensions : “.mp3”/ “.wma”

The DTS is not supported. In case of DTS audio format, audio is not output

## Compatible USB Devices

- MP3 Player : Flash type MP3 player.
- USB Flash Drive :  
Devices that support USB2.0 or USB1.1.
- The USB function of this unit does not support all USB devices.

## USB device requirement

- Devices which require additional program installation when you have connected it to a computer, are not supported.
- Do not extract the USB device while in operation.
- For a large capacity USB, it may take longer than a few minute to be searched.
- To prevent data loss, back up all data.
- If you use a USB extension cable or USB hub, the USB device is not recognized.
- Using NTFS file system is not supported. (Only FAT(16/ 32) file system is supported.)
- This unit is not supported when the total number of files is 1000 or more.
- External HDD, Card readers, Locked devices, or hard type USB devices are not supported.
- USB port of the unit cannot be connected to PC. The unit cannot be used as a storage device.
- Some USB may not work with this unit.

## Playback effect

The unit supports various sound and playback effects : SMART DJ, AUTO DJ, DJ EFFECT, and JUKE BOX playback.

### SMART DJ playback

SMART DJ plays music with various sound and playback effects : auto effect, cross fade, back spin, beat box, and voice sampling.

It plays repeatedly all the music in the USB device and gives various effects randomly.

You can enjoy it with 3 types of genre : ELECTRO, HOUSE and REGUETON. Press **SMART DJ** repeatedly. The display window changes each time you press **SMART DJ** as followings : SMART DJ OFF -> SMART DJ ELECTRO -> SMART DJ HOUSE -> SMART DJ REGUETON.

To cancel it, press **SMART DJ** repeatedly until "SMART DJ OFF" appears on the display window. You can listen to music as usual.

### ! Note

- Find sound and playback effects below.

Effect	Description
Auto effect	Auto effect blends various sound effects to fit the mood automatically. It includes flanger, phaser, delay, and chorus.
Cross fade	It playbacks to seamlessly fade from one song into the beginning of another.
Back spin	It playbacks a section of music fast in reverse.
Beat box	It inserts a beat box during playback.
Voice sampling	It inserts a sound during playback.

- You can identify the effect by hearing the sound, not by display window.
- It is recommended to play only the certain genres (ELECTRO, HOUSE, REGUETON) on SMART DJ mode. SMART DJ is optimized to enjoy that music.
- If the function changes to the others or turn off and on the unit on SMART DJ mode, SMART DJ will be turned off.
- If SMART DJ is turned off, you should turn it on again to enjoy the effect.
- It is impossible to operate SMART DJ and AUTO DJ at the same time. If you select one, another will be turned off automatically.
- SMART DJ is supported only on USB function

## DJ effect

It allows you to enjoy DJ effect such as scratch sound and several kinds of voices yourself. This function is supported on all sources.

1. Rotate **DJ EFFECT** on the unit. The display window changes each time you rotate **DJ EFFECT** as followings : OFF -> SCRATCH -> VOICE 1 -> VOICE 2 -> VOICE 3.

Display Window	Description
SCRATCH	You can hear two kinds of scratch sound depending on the direction in which you turn <b>CONTROL</b> .
VOICE 1/2/3	You can hear only one kind of the sound regardless of the direction in which you turn <b>CONTROL</b> .

2. Rotate **CONTROL** on the unit during playback. To cancel it, rotate **DJ EFFECT** until "DJ EFFECT OFF" appears on the display window.

## AUTO DJ playback

Auto DJ blends the end of one song into the beginning of another for seamless playback. It equalizes volume across files for uninterrupted playback.

Press **AUTO DJ** on the remote control or unit repeatedly, the display changes as followings. RANDOM (AUTO DJ RANDOM) -> REPEAT ALL (AUTO DJ SEQUENTIAL) -> (AUTO DJ OFF)

Mode	Display Window	Description
OFF	AUTO DJ OFF	-
RANDOM	AUTO DJ RANDOM	The music is played randomly on this mode.
REPEAT ALL	AUTO DJ SEQUENTIAL	The all music is played repeatedly on this mode.

### ! Note

- It is not supported on the AUTO DJ mode to search for a section within a file or to play repeatedly or randomly.
- If you move to other functions or stop the music using **STOP** on the unit (or **■** on the remote control) on AUTO DJ mode, AUTO DJ function will be disable.
- AUTO DJ function is not supported in the music file whose length is less than 60 seconds.
- Only AUTO DJ SEQUENTIAL is selected when played JUKE BOX list.
- You can only use AUTO DJ playback when using USB playback.

## JUKE BOX Playback (Program play)

JUKE BOX function enables you to make a playlist of your favorite files from a USB device. A playlist of up to 100 files can be entered.

### Making JUKE BOX list

It is supported only on stop status.

1. Press and hold **JUKE BOX** to enter the edit mode.
2. Select a file by pressing **◀◀/▶▶** on the remote control.
3. Press **JUKE BOX** to save the file.
4. Repeat 2 to 3 to store the other files.  
(You can modify the list by pressing **▲/▼** to select the JUKE BOX program number.)
5. Press **JUKE BOX** once again.

To play the JUKE BOX list, press **▶** after you make the list.

### Enjoying JUKE BOX

Press **JUKE BOX** twice on stop status. "JUKE BOX ON" appears on the display window. To play JUKE BOX list, press **▶** on the remote control or **PLAY/PAUSE** on the unit.

To cancel it, press **JUKE BOX** twice. "JUKE BOX OFF" appears on the display window.

### Deleting JUKE BOX list

Deleting function is worked only on the edit mode. Refer to "Making JUKE BOX list" step 1.

1. Select a song by pressing **JUKE BOX** repeatedly or pressing **▲/▼**.
2. Press **DELETE** while a song is selected.

### ! Note

- To check the status of JUKE BOX, press **JUKE BOX** once. You can also check it by the word "PROG." on the display window.
- If there is no JUKE BOX list, "JUKE BOX NONE" appears on the display window when you press **JUKE BOX**.
- JUKE BOX is switched off in the case below.
  - Changing the function to the others.
  - Turning off and on the unit.
  - Operating the numeric buttons on the remote control.
- JUKE BOX list is cleared in the case below.
  - Removing the USB device.
  - Deleting or recording music files in the USB device.
- You can only use JUKE BOX playback when using USB playback.

## Enjoying various sound mode

You can enjoy various sound mode. For details, refer to "Setting the USER EQ", "Sound effect" and "Bass Blast".

### Setting the USER EQ

You can listen to music with desired sound effect by adjusting the BASS, MIDDLE and TREBLE.

1. Press **USER EQ** on the front panel. "USER EQ" appears on the display window.
2. Press **ENTER** on the front panel while the "USER EQ" is displayed in the display window.
3. Select the BASS, MIDDLE or TREBLE by pressing **PLAY/PAUSE** on the front panel.
4. Rotate **CONTROL** on the front panel to set sound level.
5. Press **ENTER** on the front panel to finish the settings.

### Sound effect

This system has a number of preset sound effects. You can select a suitable sound effect. Rotate **SOUND EFFECT** on the remote control or on the front repeatedly until the desired sound effect appears on the display window.

Display	Description
NATURAL	You can enjoy comfortable and natural sound.
Local specialization equalizer	Regionally optimized sound effect. (DANGDUT/ ARABIC/ PERSIAN/ INDIA/ REGUETON/ MERENGUE/ SAMBA/ SALSA/ CUMBIA/ AFRO(AFRO Hip Hop))
AUTO EQ	Sets the sound equalizer to the mode that is the most similar to the genre which is included in the MP3 ID3 tag of song files.
POP CLASSIC JAZZ ROCK	This program lends an enthusiastic atmosphere to the sound, giving you the feeling you are at an actual pop, classic, jazz or rock concert.
MP3-OPTIMIZER	This function is optimized for compressible MP3 file. It improves the treble sound.
BASS BLAST	During playback, reinforces the bass sound.
LOUDNESS	Improves the bass and treble sound.
FOOTBALL	You can enjoy the sound effect FOOTBALL STADIUM.
3D SOUND	3D Sound features deliver sound creating a wider spot so you can enjoy more immersive and cinematic surround sound.
BYPASS	You can enjoy the sound without equalizer effect.

### ! Note

- In some of surround modes, some speakers, there's no sound or low sound. It depends on the mode of surround and the source of audio, it is not defective.
- You may need to reset the surround mode, after switching the input, sometimes even after the sound track changed.
- Depending on region, specific Local specialization equalizer is selected.

## Bass Blast

You can set the BASS BLAST sound mode directly. Press **BASS BLAST** repeatedly.

Display	Description
BASS BLAST	During playback, reinforces the bass sound.
BYPASS	You can enjoy the sound without equalizer effect.

## Using a Bluetooth wireless technology

### About Bluetooth

**Bluetooth®** is wireless communication technology for short range connection.

The sound may be interrupted when the connection interfered by the other electronic wave or you connect the bluetooth in the other rooms.

Connecting individual devices under **Bluetooth®** wireless technology does not incur any charges. A mobile phone with **Bluetooth®** wireless technology can be operated via the Cascade if the connection was made via **Bluetooth®** wireless technology. Available Devices : Mobile phone, MP3, Laptop, PDA.

### Bluetooth Profiles

In order to use **Bluetooth®** wireless technology, devices must be able to interpret certain profiles. This unit is compatible with following profile. A2DP (Advanced Audio Distribution Profile)

## Listening to music stored on the Bluetooth devices

Before you start the pairing procedure, make sure the Bluetooth feature is turned on in to your Bluetooth device. Refer to your Bluetooth device's user guide. Once a pairing operation is performed, it does not need to be performed again.

1. Select the Bluetooth function by using the **BLUETOOTH** on the remote control or rotating **INPUT SELECTION** on the front panel. "BT READY" appears on the display window.
2. Operate the Bluetooth device and perform the pairing operation. When searching for this unit with the Bluetooth device, a list of the devices found may appear in the Bluetooth device display depending on the type of Bluetooth device. Your unit appears as "LG AVR (XX:XX)".

### ! Note

- XX:XX means the last four digits of BT address. For example, if your unit has a BT address such as 9C:02:98:4A:F7:08, you will see "LG AVR (F7:08)" on your Bluetooth device.
- Depending on the Bluetooth device type, some device have a different pairing way. Enter the PIN code (0000) as needed.

4

Operating



3. When this unit is successfully connected with your Bluetooth device, "PAIRED" will appear on the display window and bluetooth indicator will be lit up.

**! Note**

Depending on the Bluetooth device type, some device have a different pairing way.

4. Listen to music.  
To play a music stored on your Bluetooth device, refer to your Bluetooth device's user guide.

**! Note**

- Sound from the main set can be distorted if you raise the volume of Bluetooth device up to two-thirds or more.
- When you use the bluetooth function, adjust the volume of a bluetooth device to a proper level to listen to.

**! Note**

- When using Bluetooth® technology, you have to make a connection between the unit and the bluetooth device as close as possible and keep the distance. However it may not work well in the case below :
  - There is a obstacle between the unit and the bluetooth device.
  - There is a device using same frequency with **Bluetooth®** technology such as a medical equipment, a microwave or a wireless LAN device.
- You should connect your Bluetooth device to this unit again when you restart it.
- The sound may be interrupted when the connection interfered by the other electronic wave.
- You cannot control the Bluetooth device with this unit.
- Pairing is limited one Bluetooth device per one unit and multi-pairing is not supported.
- Depending on the type of the device, you may not be able to use the Bluetooth function.
- You can enjoy wireless system using phone, MP3, Notebook, etc..
- When not connected the Bluetooth, "BLUETOOTH" and "BT READY" appears on the control panel.
- When someone stands and interrupts communication between Bluetooth device and the player, the connection will be disconnected.
- The more distant between the unit and the bluetooth device, the lower the sound quality becomes.
- When Bluetooth connection is disconnected, connect the bluetooth device to the unit again.

## Using Bluetooth App

### ! Note

Only Android OS is available to use "LG Bluetooth Remote" app with this unit.

### About "LG Bluetooth Remote" App

"LG Bluetooth Remote" app brings a suite of new features to this unit.

To enjoy more features, you are recommended to download and install free "LG Bluetooth Remote" app.

### Install "LG Bluetooth Remote" App onto Your Bluetooth Device

1. Install "LG Bluetooth Remote" app through QR code. Use the scanning software to scan the QR code.



2. Tap an icon for installation.
3. Tap an icon for downloading.

### ! Note

- Make sure that your Bluetooth device is connected to the Internet.
- Make sure that your Bluetooth device has a scanning software application. If you don't have one, download one from "Google Android Market (Google Play Store)".

### Install "LG Bluetooth Remote" App through "Google Android Market (Google Play Store)"

1. Tap the "Google Android Market (Google Play Store)" icon.
2. In the search bar, type in the "LG Bluetooth Remote" and search it.
3. In the search result list, find and tap "LG Bluetooth Remote" to start downloading Bluetooth app.
4. Tap an icon for installation.
5. Tap an icon for downloading.

### ! Note

- Make sure that your Bluetooth device is connected to the Internet.
- Make sure that your Bluetooth device is equipped with "Google Android Market (Google Play Store)".

## Activate Bluetooth with “LG Bluetooth Remote” App

“LG Bluetooth Remote” app helps to connect your bluetooth device to this unit.

1. Tap “LG Bluetooth Remote” app icon on the home screen to open “LG Bluetooth Remote” app, and go to the main menu.
2. Tap [Setting] and select the unit you want.
3. If you want to get more information to operate, tap [Setting] and [Help].

### Note

- BT app will be available in the software version as follow;
  - Android O/S : Ver 2.3.3 (or later)
- This unit does not support the multi-pairing. If this unit is already connected with other Bluetooth device, disconnect that device and then try again.
- If you use “LG Bluetooth Remote” app for operation, there would be some differences between “LG Bluetooth Remote” app and the supplied remote control. Use the supplied remote control as necessary.
- Depending on the Bluetooth device, “LG Bluetooth Remote” app may not work.
- The connection you’ve made may be disconnected if you select other application or change the setting of the connected device via “LG Bluetooth Remote” app. In such a case, please check the connection status.
- After connection of BT app, music may be output from your device. In this case, try connecting procedure again.

## Radio Operations

Be sure that FM antenna is connected.(Refer to the page 19.)

### Listening to FM radio

1. Press **RADIO** on the remote control or turn **INPUT SELECTION** on the unit until FM appears on the display window.

The last received station is tuned in.

2. Auto tuning :  
Press and hold **TUNING -/+** for about 2 seconds until the frequency indication starts to change, then release. Scanning stops when the unit tunes in a station.

Manual tuning :

Press **TUNING -/+** on the remote control repeatedly.

3. Adjust the volume by pressing **VOL+/-** on the remote control or turn **MASTER VOLUME** on the unit.

### Improving poor FM reception

Press **MONO/STEREO** on the remote control. This will change the tuner from stereo to mono and usually improve the reception.

## Presetting the Radio Stations

You can preset 50 stations for FM.

Before tuning, make sure to turn down the volume.

1. Tune in to a radio station.
2. Press **ENTER/SET**. A preset number will blink in the display window.
3. Press **PRESET +/-** to select the preset number you want.
4. Press **ENTER/SET**. The station is stored.
5. Repeat steps 1 to 4 to store the other stations.
6. To listen to a preset station, press **PRESET +/-** or 0 to 9 numerical buttons.

## Deleting all the saved stations

1. Press and hold **DELETE** for two seconds. "ERASE ALL?" will flash up on the unit display.
2. Press **ENTER** to erase all the saved radio stations.

## Other Operations

### Dimmer

Press **SLEEP** once. The display window is darkened by half and the lighting is turned off. To cancel it, press **SLEEP** repeatedly until dim off.

### Using the Sleep Timer

You can set the unit to turn off automatically at a specified time. Press **SLEEP** repeatedly.

The indicator changes cyclically in the display window as follows.

SLEEP 180 -> 150 -> 120 -> 90 -> 80 -> 70 -> 60 -> 50 -> 40 -> 30 -> 20 -> 10 -> Off (No display)

To check the remaining time, press **SLEEP**. The remaining time appears on the display window.

To cancel the sleep function, press **SLEEP** repeatedly until "SLEEP 10" appears, and then press **SLEEP** once again while "SLEEP 10" is displayed.

#### Note

When the sleep timer is activated, the display window dims and the lighting is turned off.

## Displaying file and input source

You can display various information of the input source by pressing **INFO**.

Function	Description
HDMI IN 1/2/3 OPTICAL 1/2 COAXIAL	Displays the audio format and audio channel. (ex : PCM 2.0 CH, etc.)
USB	Displays the file information during MP3/WMA playback and audio channel. (ex : FILE-XXXXXX)

## Auto power down

This unit will be off itself to save electric consumption in the case main unit is not connected to external device and is not used for 20 minutes.

So does this unit after six hours since Main unit has been connected to other device using analog input.

## Advanced Operations

### Recording to USB

You can record a various sound source to USB. (AUX1/2 ,PORTABLE, FM)

1. Connect the USB device to the unit.
2. Select a function in which you want to record by using **INPUT SELECTION** on the unit or **INPUT** on the remote control.
3. Press **REC** on the remote control.
4. To stop recording, press **STOP** on the unit or **REC** on the remote control.

### Pausing recording

During recording, press **PLAY/PAUSE** on the unit or **II** on the remote control to pause recording.

Press **PLAY/PAUSE** on the unit or **▶** on the remote control to restart recording.

### To select recording bit rate

1. Press **REC** on the remote control for longer than 3 seconds.
2. Press **◀◀/▶▶** on the remote control to select a bit rate.
3. Press **REC** on the remote control again to finish the setting.

### Note

- It is not supported to record music stored on bluetooth, HDMI IN , COAXIAL and OPTICAL IN sources.
- When you stop recording during playback, the file that has been recorded at that time will be stored.
- Do not remove the USB device or turn off the unit during USB recording. If does not, an incomplete file may be made and not deleted on PC.
- If USB recording does not work, the message like "NO REC","USB ERR","USB FULL" is displayed on the display window.
- Multi card reader device or External HDD can not be used for USB recording.
- A file is recorded by about 512 Mbyte when you record for a long term.
- You may not store more than 999 files.
- You can check recording elapsed time by pressing **INFO**, button on the remote control.
- It'll be stored as follows.

Tuner	The other source*
<ul style="list-style-type: none"> <li>■ TUNER_REC</li> <li>├─ AUDIO_001_87-50FM</li> <li>├─ AUDIO_002_87-60FM</li> <li>└─ ⋮</li> </ul>	<ul style="list-style-type: none"> <li>■ OTHERS_REC</li> <li>├─ AUDIO_001</li> <li>├─ AUDIO_002</li> <li>└─ ⋮</li> </ul>

- TUNER : The current recording frequency is shown.
- \* : PORTABLE and the like.

The making of unauthorized copies of copy-protected material, including computer programs, files, broadcasts and sound recordings, may be an infringement of copyrights and constitute a criminal offense. This equipment should not be used for such purposes.

**Be responsible**  
**Respect copyrights**

# Troubleshooting

PROBLEM	CAUSE & CORRECTION
The unit does not work properly.	<ul style="list-style-type: none"> <li>• Turn off the power of this unit and the connected external device (TV, Woofer, DVD-player, Amplifier, etc.) and turn it on again.</li> <li>• Disconnect the power cord of this unit and the connected external device (TV, Woofer, DVD-player, Amplifier, etc.) and then try connecting again.</li> </ul>
No Power	<ul style="list-style-type: none"> <li>• The power cord is unplugged. Plug in the power cord.</li> <li>• Check the condition by operating other electronic devices.</li> </ul>
No sound	<ul style="list-style-type: none"> <li>• The speaker wires are disconnected. Check the speaker connections.</li> <li>• The volume is set to minimum. Adjust the volume level.</li> <li>• Incorrect input source is selected. Check the input source and select the correct input source.</li> <li>• The mute function is activated. Press <b>MUTE</b> or adjust the volume level to cancel the mute function.</li> </ul>
No lighting	<ul style="list-style-type: none"> <li>• The Dimmer or the Sleep function is activated. Press <b>SLEEP</b> to cancel the function.</li> </ul>
Radio stations cannot be tuned in properly.	<ul style="list-style-type: none"> <li>• The antenna is positioned poorly. Adjust its position.</li> <li>• The signal strength of the radio station is too weak. Tune to the station manually.</li> <li>• No stations have been preset or preset stations have been cleared (when tuning by scanning preset channels). Preset some radio stations, see page 36 for details.</li> </ul>
The remote control does not work properly.	<ul style="list-style-type: none"> <li>• The remote control is too far from the unit. Operate the remote control within about 23 ft (7 m).</li> <li>• There is an obstacle in the path of the remote control and the unit. Remove the obstacle.</li> <li>• The batteries in the remote control are exhausted. Replace the batteries with new one.</li> </ul>

## Trademarks and licenses



The terms HDMI and HDMI High-Definition Multimedia Interface, and the HDMI logo are trademarks or registered trademarks of HDMI Licensing LLC in the United States and other countries.



Manufactured under license from Dolby Laboratories. Dolby and the double-D symbol are trademarks of Dolby Laboratories.



*Bluetooth*® wireless technology is a system which allows radio contact between electronic devices.

Connecting individual devices under *Bluetooth*® wireless technology does not incur any charges. A mobile phone with *Bluetooth*® wireless technology can be operated via the Cascade if the connection was made via *Bluetooth*® wireless technology.

The *Bluetooth*® word mark and logos are owned by the *Bluetooth*® SIG, Inc. and any use of such marks by LG Electronics is under license.

Other trademarks and trade names are those of their respective owners.

## Maintenance

### Handling the unit

#### When shipping the unit

Please save the original shipping carton and packing materials. If you need to ship the unit, for maximum protection, re-pack the unit as it was originally packed at the factory.

#### Keeping the exterior surfaces clean

- Do not use volatile liquids such as insecticide spray near the unit.
- Wiping with strong pressure may damage the surface.
- Do not leave rubber or plastic products in contact with the unit for a long period of time.

#### Cleaning the unit

To clean the player, use a soft, dry cloth. If the surfaces are extremely dirty, use a soft cloth lightly moistened with a mild detergent solution. Do not use strong solvents such as alcohol, benzene, or thinner, as these might damage the surface of the unit.



## Specifications

General	
Power requirements	Refer to the main label.
Power consumption	Refer to the main label.
Dimensions (W x H x D)	(430 x 147.5 x 368) mm
Net Weight (Approx.)	4.7 kg
Operating temperature	5 °C to 35 °C
Operating humidity	5 % to 90 %
Bus Power Supply	5 V  500 mA

Input/Output	
ANALOG AUDIO IN	2.0 Vrms (1 kHz, 0 dB), 600 Ω, RCA jack (L, R) x 2
ANALOG VIDEO IN	1.0 Vrms (p-p), 75 Ω, sync negative, RCA jack x 1
OPTICAL IN	3.0 Vrms (p-p), Optical jack x 2
COAXIAL IN	3.0 Vrms (p-p), Coaxial jack x 1
PORT. IN	0.5 Vrms (∅ 3.5 mm stereo jack) x 1
HDMI IN/OUT	19 pin (Type A, HDMI™ connector)
AUDIO OUT	2.0 Vrms (1 kHz, 0 dB), 600 Ω, RCA jack (L, R) x 1
VIDEO OUT	1.0 Vrms (p-p), 75 Ω, sync negative, RCA jack x 1

Tuner	
FM Tuning Range	87.5 MHz to 108.0 MHz or 87.50 MHz to 108.00 MHz

Amplifier		
Stereo mode	460 W (6 Ω at 1 kHz) x 2	
Surround mode	Front	460 W (6 Ω at 1 kHz) x 2
	Sub woofer	465 W (6 Ω at 70 Hz) x 2

Front speakers/Subwoofers		
Type	Front Speaker	2 Way 2 Speaker
	Subwoofer	1 Way 1 Speaker
Impedance	Front Speaker	6 $\Omega$
	Subwoofer	6 $\Omega$
Rated Input Power	Front Speaker	460 W x 2
	Subwoofer	465 W x 2
Max. Input Power	Front Speaker	920 W x 2
	Subwoofer	930 W x 2
Net Dimensions (W x H x D)		(360 X 1190 X 300.5) mm
Net Weight(1EA)		23.76 Kg

- Designs and specifications are subject to change without prior notice.



