

OWNER'S MANUAL

AIR CONDITIONER

Please read this manual carefully before operating your set and retain it for future reference.

TYPE : WALL MOUNTED



P/NO : MFL67734508

www.lg.com

TIPS FOR SAVING ENERGY

Here are some tips that will help you minimize the power consumption when you use the air conditioner. You can use your air conditioner more efficiently by referring to the instructions below:

- Do not cool excessively indoors. This may be harmful for your health and may consume more electricity.
- Block sunlight with blinds or curtains while you are operating the air conditioner.
- Keep doors or windows closed tightly while you are operating the air conditioner.
- Adjust the direction of the air flow vertically or horizontally to circulate indoor air.
- Speed up the fan to cool or warm indoor air quickly, in a short period of time.
- Open windows regularly for ventilation as the indoor air quality may deteriorate if the air conditioner is used for many hours.
- Clean the air filter once every 2 weeks. Dust and impurities collected in the air filter may block the air flow or weaken the cooling / dehumidifying functions.

For your records

Staple your receipt to this page in case you need it to prove the date of purchase or for warranty purposes. Write the model number and the serial number here:

Model number : _____

Serial number : _____

You can find them on a label on the side of each unit.

Dealer's name : _____

Date of purchase : _____

IMPORTANT SAFETY INSTRUCTIONS

READ ALL INSTRUCTIONS BEFORE USING THE APPLIANCE.

Always comply with the following precautions to avoid dangerous situations and ensure peak performance of your product

WARNING

It can result in serious injury or death when the directions are ignored

CAUTION

It can result in minor injury or product damage when the directions are ignored

WARNING

- Installation or repairs made by unqualified persons can result in hazards to you and others.
- Installation **MUST** conform with local building codes.
- The information contained in the manual is intended for use by a qualified service technician familiar with safety procedures and equipped with the proper tools and test instruments.
- Failure to carefully read and follow all instructions in this manual can result in equipment malfunction, property damage, personal injury and/or death.

Installation

- Use a standard circuit breaker and fuse conforming with the rating of the air conditioner. Failure to do so may result in electric shock or product failure.
- Contact an authorized service center when you install or relocate the air conditioner. Failure to do so may result in serious injury or product failure.
- Always use a power plug and socket with a ground terminal. Failure to do so may result in electric shock or product failure
- Install the panel and the cover of the control box safely. Failure to do so may result in explosion or fire.
- Install a dedicated electric outlet and circuit breaker before you use the air conditioner. Failure to do so may result in electric shock or product failure.
- Use a standard circuit breaker and fuse conforming with the rating of the air conditioner. Failure to do so may result in electric shock or product failure.
- Do not modify or extend the power cable. If the power cable or cord has scratches or skin peeled off or deteriorated then it must be replaced. It may result in fire or electric shock.
- Be cautious when you unpack or install the air conditioner. Failure to do so may result in serious injury or product failure.
- Contact an authorized service center when you install or relocate the air conditioner. Failure to do so may result in serious injury or product failure.
- Do not install the air conditioner on an unstable surface or where there may be a danger of it falling. It may result in death, serious injury, or product failure.

Operation

- Do not let the air conditioner run for a long time when the humidity is very high or when a door or window has been left open. Failure to do so may result in product failure.
- Make sure that the power cord is not pulled or damaged while the air conditioner is operating. Failure to do so may result in fire, electric shock, or product failure.
- Do not place any objects on the power cord. It may result in electric shock or product failure.
- Do not turn on or off the air conditioner by plugging in or unplugging the power plug. It may result in fire or electric shock.
- Do not touch, operate or repair the air conditioner with wet hands. It may result in electric shock or product failure.
- Do not place a heater or other heating appliances near the power cable. It may result in fire, electric shock, or product failure.
- Do not allow water to run into the air conditioner. It may result in explosion or fire.
- Do not leave flammable substances such as gasoline, benzene and thinner near the air conditioner. It may result in explosion or fire.
- Do not use the air conditioner for an extended period of time in a small place without ventilation. Ventilate the place regularly. Failure to do so may result in explosion or fire.
- When there is a gas leak, ventilate sufficiently before using the air conditioner again. Failure to do so may result in explosion or fire.
- Unplug the power plug if there is a noise, smell or smoke coming from the air conditioner. Failure to do so may result in explosion or fire.
- Stop operating and close the window in storm or hurricane. If possible remove the product from the window before hurricane arrives
- Do not touch the electrostatic filter after opening the front grille. Failure to do so may result in electric shock or product failure.
- Contact an authorized service center when the air conditioner is submerged into water due to flooding. Failure to do so may result in explosion or fire.
- Be cautious water could not enter the product
- Make sure to ventilate sufficiently when this air conditioner and a heating appliance such as a heater are used simultaneously. Failure to do so may result in fire, serious injury, or product failure.
- Turn the main power off and unplug the power plug when you clean or repair the air conditioner. Failure to do so may result in death, serious injury, or product failure.
- Unplug the power plug when the air conditioner is not used for an extended period of time. Failure to do so may result in product failure.
- Do not place any objects on the air conditioner. It may result in product failure.
- For inner cleaning, contact an Authorized Service Center or a dealer.
Do not use harsh detergent that causes corrosion or damage on the unit.
Harsh detergent may also cause failure of product, fire, or electronic shock.

 **CAUTION****Installation**

- Make sure to check if there is a refrigerant leak after you install or repair the air conditioner. Failure to do so may result in product failure.
- Install the drain hose properly for smooth drainage of condensed water. Failure to do so may result in product failure.
- Keep level even when installing the product.
- Install the air conditioner where the noise from the outdoor unit or the exhaust gas will not inconvenience the neighbors. Failure to do so may result in conflict between neighbors.
- When transporting the equipment, there should be at least 2 or more people, or a forklift. It may result in serious injury.
- Do not install the air conditioner where it will be exposed to sea wind (salt spray) directly. It may result in product failure.

Operation

- Do not expose people, animals or plants to the cold or hot wind from the air conditioner. It may result in serious injury.
- Do not use the product for special purposes, such as preserving foods, works of art, etc. It is a consumer air conditioner, not a precision refrigeration system. It may result in death, fire or electric shock.
- Do not block the inlet or outlet of air flow. It may result in explosion or product failure.
- Do not use strong cleaning agents or solvents when you clean the air conditioner, or spray water. Use a smooth cloth. It may result in serious injury or product failure.
- Never touch the metal parts of the air conditioner when you remove the air filter. It may result in serious injury or product failure.
- Do not place any objects on the air conditioner. It may result in product failure.
- Always insert the filter securely after cleaning. Clean the filter every two weeks or more often if necessary.
- Do not insert hands or other objects through the air inlet or outlet while the air conditioner is operating. It may result in electric shock.
- Do not drink the water drained from the air conditioner. It may result in serious health complications.
- Use a sturdy stool or ladder when you clean, maintain or repair the air conditioner at a height. Failure to do so may result in serious injury or product failure.
- Do not mix the batteries for the remote control with other types of batteries or mix new batteries with used batteries. Failure to do so may result in product failure.
- Do not recharge or disassemble the batteries. Failure to do so may result in explosion, fire or serious injury.
- Stop using the remote control if there is a battery fluid leak. If your cloth or skin is exposed to the battery fluid from a leak, wash it off with clean water. Failure to do so may result in serious injury.
- If you swallow the battery fluid from a leak, wash out the inside of your mouth thoroughly and then consult a doctor. Failure to do so may result in serious health complications.

TABLE OF CONTENTS

2 TIPS FOR SAVING ENERGY

3 IMPORTANT SAFETY INSTRUCTIONS

7 ELECTRICAL SAFETY

- 7 Temporary Use of an Adapter
- 7 Temporary Use of an Extension Cord
- 7 Symbols used in this Manual

8 BEFORE USE

- 8 Components
- 9 Using the remote control
- 10 - Inserting batteries
- 10 - Installing the remote control holder

11 BASIC FUNCTIONS

- 11 Cooling your room
- 11 Heating your room
- 11 Removing humidity
- 12 Airing your room
- 12 Adjusting the fan speed
- 12 Adjusting the air flow direction
- 12 Setting the timer
- 12 - Setting the current time
- 13 - Turning on the air conditioner automatically at a set time
- 13 - Turning off the air conditioner automatically at a set time
- 13 - Canceling the timer setting
- 13 - Setting simple timer mode

14 ADVANCED FUNCTIONS

- 14 Changing room temperature quickly
- 14 Indoor air purification
- 14 - Auto Clean operation
- 15 Plasma Purification operation (Optional)
- 15 Auto operation (Optional)
- 16 Auto Changeover operation (Optional)
- 16 Energy saving cooling mode
- 16 Display screen brightness
- 17 Using the 1 Touch soft air
- 17 Setting Comfort Sleep mode
- 18 Operating the air conditioner without the remote control
- 18 Restarting the air conditioner automatically

19 MAINTENANCE

- 20 Cleaning the Air filter
- 20 Cleaning 3M filter(Optional)
- 20 Cleaning the plasma (+HAF) filter (Optional)

21 TROUBLESHOOTING

- 21 Self-diagnosis function
- 21 Before requesting service
- 22 Operation ranges
- 23 Details of LG serial No.

24 SPECIFICATION

ELECTRICAL SAFETY

WARNING

- This appliance must be properly grounded. To minimize the risk of electric shock, you must always plug into a grounded outlet.
- Do not cut or remove the grounding prong from the power plug.
- Attaching the adapter ground terminal to the wall receptacle cover screw does not ground the appliance unless the cover screw is metal and not insulated, and the wall receptacle is grounded through the house wiring.
- If you have any doubt whether the air conditioner is properly grounded, have the wall receptacle and circuit checked by a qualified electrician.

Temporary Use of an Adapter

We strongly discourage the use of an adapter due to potential safety hazards. For temporary connections, use only a genuine adapter, available from most local hardware stores. Ensure that the large slot in the adapter is aligned with the large slot in the receptacle for a proper polarity connection.

To disconnect the power cord from the adapter, use one hand on each to avoid damaging the ground terminal. Avoid frequently unplugging the power cord as this can lead to eventual ground terminal damage.

WARNING

- Never use the appliance with a broken adapter.

Temporary Use of an Extension Cord

We strongly discourage the use of an extension cord due to potential safety hazards.

WARNING

- This appliance should be installed in accordance with national wiring regulations. This guide acts as a guide to help to explain product features.

Symbols used in this Manual

 This symbol alerts you to the risk of electric shock.

 This symbol alerts you to hazards that may cause harm to the air conditioner.

 This symbol indicates special notes.

BEFORE USE

Components

Indoor unit

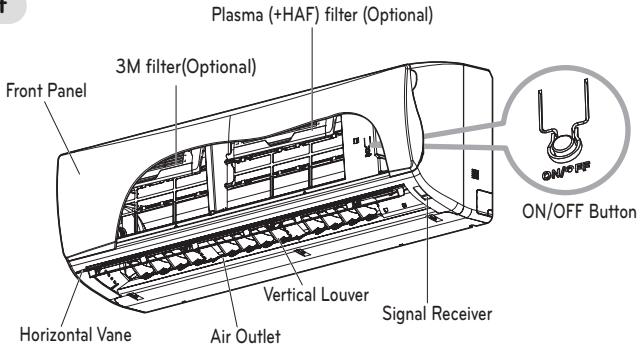

NOTE

The number of operation lamps and their locations may vary, depending on the model of the air conditioner.

Operation Indication lamps

	Temperature display : lamp indicates the desired temperature
	Timer : lamp lights up during Timer setting set.
	Outdoor unit operation : lamp lights up during operating the outdoor unit.
	Defrosting : lamp lights up during preheating and defrosting
	Power : lamp lights up during the unit turned on.
	Energy Saving : lamp lights up during Energy saving cooling mode.

* The feature can be changed according to type of model.

Outdoor unit

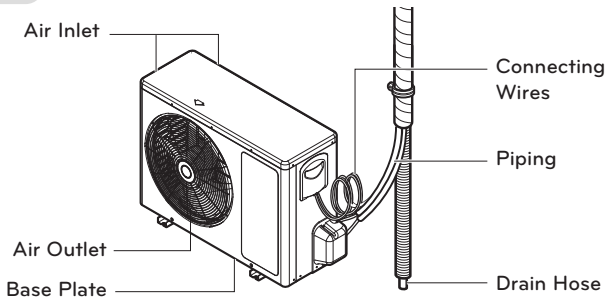

* The feature can be changed according to type of model.

Using the remote control

You can operate the air conditioner more conveniently with the remote control. You will find the buttons for the additional functions under the cover of the remote control.

Wireless remote control

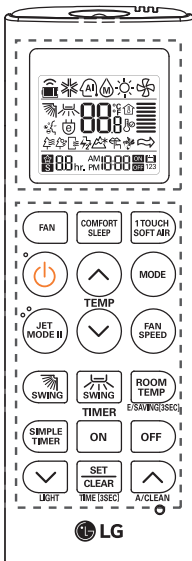
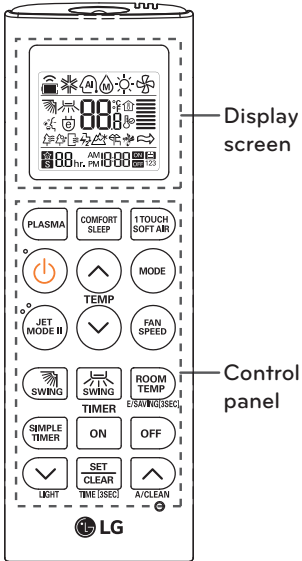

Control panel	Display screen	Description
		Plasma button* : Purifies the air by removing particles that enter the indoor unit.
		Air circulation button* : Used to circulate the room air without cooling or heating.
		Comfort sleep button* : Set the sleep mode auto operation
		1 Touch soft air button : Easily adjust the air flow to deflect direct wind away.
		Temperature adjustment buttons : Adjusts the room temperature when cooling and heating.
	-	On/Off button : Turns the power on/off.
		Indoor fan speed button : Adjusts the fan speed.
		Operation mode selection button* : Selects the operation mode. Cooling operation (❄️) / Auto operation or auto changeover (Ⓜ️) / Dehumidifying operation (💧) / Heating operation (🔥) / Air circulation (🌀)
		Jet mode II button : Cools down the indoor temperature within a short period of time
		Air flow direction button : Adjusts the air flow direction vertically or horizontally.
		Temperature display button : Displays the room temperature. Ⓜ️: Operates energy saving cooling
		Timer button : Sets the current time and the start / end time.
		Functions button* : Adjusts the time and sets the special functions. 🧹: Auto clean
	-	Light button : Adjusts the brightness of the indoor unit display
	-	Set/clear button : Sets or cancels functions.
	-	Reset button : Initialize the air conditioner settings.

* Some functions may not be supported, depending on the model.

Inserting batteries

Insert batteries before using the remote control. The battery type used is AAA (1.5 V).

- 1 Remove the battery cover.

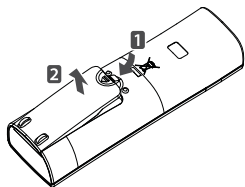

- 2 Insert the new batteries and make sure that the + and - terminals of the batteries are installed correctly.

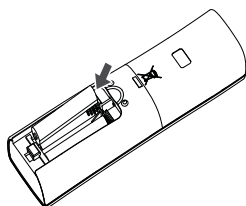

- 3 Reattach the battery cover.

NOTE

If the display screen of the remote control starts to fade, replace the batteries.

Installing the remote control holder

Install the holder where there is no direct sunlight to protect the remote control.

- 1 Choose a safe and easily-accessible place.

- 2 Fix the holder by fastening the 2 screws firmly with a screwdriver.

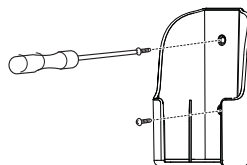

- 3 Slide the remote control into the holder.

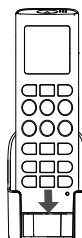

Operating method

Point the remote control towards the signal receiver at the bottom of the air conditioner to operate it.

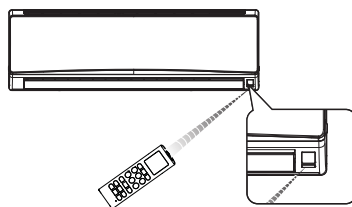



NOTE

- The remote control may operate other electronic devices if pointed towards them. Make sure to point the remote control towards the signal receiver of the air conditioner.
- For proper operation, use a soft cloth to clean the signal transmitter and receiver.



BASIC FUNCTIONS

Cooling your room

(Cooling operation)

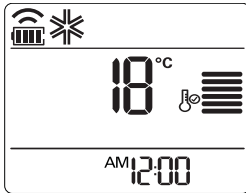

- 1 Press  to turn on the power.
- 2 Press  repeatedly to select the cooling operation.
-  is displayed on the display screen.





- 3 Press  or  to set the desired temperature.
- The temperature range is 18°C - 30°C.

Heating your room

(Heating operation)

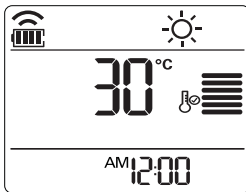
- 1 Press  to turn on the power.
- 2 Press  repeatedly to select the heating operation.
-  is displayed on the display screen.



- 3 Press  or  to set the desired temperature.
- The temperature range is 16°C - 30°C.



NOTE

Cooling-only models do not support this function.

Removing humidity

(Dehumidifying operation)

This mode removes excess moisture from an environment with high humidity or in the rainy season, in order to prevent mold from setting in. This mode adjusts the room temperature and the fan speed automatically to maintain the optimal level of humidity.

- 1 Press  to turn on the power.
- 2 Press  repeatedly to select the dehumidifying operation.
-  is displayed on the display screen.

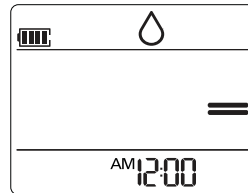

NOTE

- In this mode you cannot adjust the room temperature, as it is adjusted automatically. Also, the room temperature is not displayed on the display screen.

Airing your room (Air Circulation operation)

This mode only circulates the indoor air without changing the room temperature. The cooling lamp lights up in air circulation mode.

- 1 Press to turn on the power.
- 2 Fan button : Press turn on the air circulation operation.

Mode button : Press repeatedly to select air circulation operation.

- is displayed on the display screen.

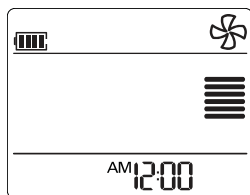

- 3 Press to adjust the fan speed.

Adjusting the fan speed

- 1 Press repeatedly to adjust the fan speed.

- Select if you want natural air.

The fan speed adjusts automatically.

Remark	Speed
	High
	Medium
	Low
	Natural Wind

Adjusting the air flow direction

- 1 To adjust the direction of the air flow horizontally, press repeatedly and select the desired direction.
 - Select to adjust the direction of the air flow automatically.
- 2 To adjust the direction of the air flow vertically, press repeatedly and select the desired direction.
 - Select to adjust the direction of the air flow automatically.

NOTE

- Adjusting the air flow direction vertically may not be supported, depending on the model.
- Adjusting the air deflector arbitrarily may cause product failure.
- If you restart the air conditioner, it starts to operate with the previously set direction of air flow, so the air deflector may not match the icon displayed on the remote control. When this occurs, press or to adjust the direction of the air flow again.

Setting the timer

You can use the timer function to save energy and to use the air conditioner more efficiently.

Setting the current time

- 1 Press and hold it for longer than 3 seconds.
 - The AM/PM icon flickers at the bottom of the display screen.

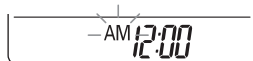



- 2 Press or to select the times.
- 3 Press to finish.

Turning on the air conditioner automatically at a set time

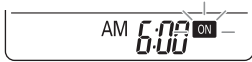
- 1 Press .
 - The icon below flickers at the bottom of the display screen.





- 2 Press  or  to select the times.
- 3 Press  to finish.
- 4 When setting the timer, current time and ON icon are displayed on the display screen indicating that the desired time is set.



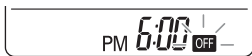

Turning off the air conditioner automatically at a set time

- 1 Press .
 - The icon below flickers at the bottom of the display screen.









- 2 Press  or  to select the times.
- 3 Press  to finish.
- 4 When setting the timer, current time and OFF icon are displayed on the display screen indicating that the desired time is set.

Canceling the timer setting

- 1 Press .
- 2 Press  or  to select the timer setting to cancel.
- 3 Press .
 - To cancel all timer settings, press .

Setting simple timer mode

Use the simple timer mode to turn off the air conditioner automatically whenever you want to stop it.

- 1 Press  to turn on the power.
- 2 Press .
- 3 Press  or  to select the hour (up to 7 hours).
- 4 Press  to finish.
 -  is displayed on the display screen in simple timer mode.

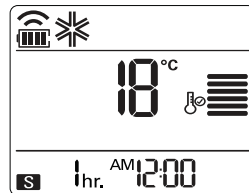

NOTE



It is not possible to set Simple Timer mode and Off Timer mode at once.

ADVANCED FUNCTIONS

The air conditioner offers some additional advanced functions.

Changing room temperature quickly (Jet Mode II)

This mode allows you to cool indoor air quickly in summer or warm it quickly in winter.

- 1 Press  to turn on the power.
- 2 Press .

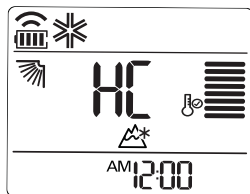

- In Jet Mode II, 30 minutes strong focused air blows out for faster cooling.

! NOTE

- In Air Circulation, Auto, or auto Changeover mode, this function cannot be used.
- During & after Jet Mode II swing function will be ON by default.
- To OFF swing function Press respective swing key.
- This function may not be supported, depending on the model.
- This mode does not have auto restart feature.

Indoor air purification

Auto Clean operation

In the cooling and dehumidifying operations, moisture is generated inside the indoor unit. Use the auto cleaning function to remove such moisture.

- 1 Press .
-  is displayed on the display screen.

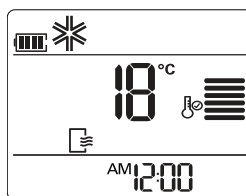



- If you turn off the power, the fan operates for 30 minutes and cleans the inside of the indoor unit.

! NOTE

Some buttons cannot be used while the auto cleaning function is in operation.

Plasma Purification operation (Optional)

The plasma filter developed by LG removes microscopic contaminants from the intake air completely to supply clean and fresh air.

- 1 Press  to turn on the power.
- 2 Press .
 -  is displayed on the display screen.

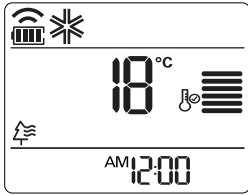





! NOTE

- You can use this function by pressing  without turning the air conditioner on.
- Both the plasma lamp and the cooling lamp light up while plasma purification is in operation.
- This function may not be supported, depending on the model.

Auto operation (Optional) (Artificial intelligence)

Cooling-only models

In this mode, the fan speed and the temperature adjust automatically, based on the room temperature.

- 1 Press  to turn on the power.
- 2 Press  repeatedly to select auto operation.
- 3 Press  or  to select the desired operation code if the temperature is higher or lower than the desired temperature.

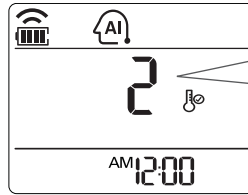



Code	Description
2	Cool
1	Cool slightly
0	Maintain room temperature
-1	Heat slightly
-2	Heat

! NOTE



- In this mode, you cannot adjust the fan speed, but you can set the air deflector to rotate automatically.
- This function may not be supported, depending on the model.

Auto Changeover operation (Optional)

This mode changes the operation mode automatically to maintain the set temperature at $\pm 2^{\circ}\text{C}$.

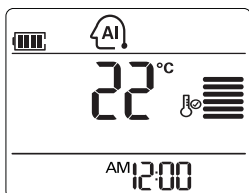
- 1 Press  to turn on the power.
- 2 Press  repeatedly to select the auto changeover operation.
 -  is displayed on the display screen.



- 3 Press  or  to set the desired temperature.
 - The temperature range is 18°C - 30°C .
- 4 Press  repeatedly to select the fan speed.

! NOTE





This function may not be supported, depending on the model.

Energy saving cooling mode

This mode minimizes power consumption during cooling and increases the set temperature to the optimal level for a more comfortable environment.

The temperature automatically sets at 22°C if ambient temperature is below 22°C .

The temperature maintains if ambient temperature is above 22°C .

- 1 Press  to turn the power on.
- 2 Press  repeatedly to select the cooling operation.
- 3 Press .
 -  is displayed on the display screen.

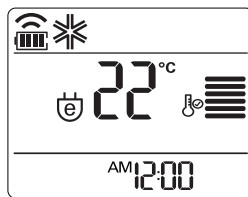

! NOTE

This function may not be supported, depending on the model.

Display screen brightness

You can adjust the brightness of the indoor unit display screen.





- 1 Press  to turn on/off the Display screen.

! NOTE

This function may not be supported, depending on the model.



Using the 1 Touch soft air (Comfort Vane operation)

The Comfort Vane option conveniently sets the vane to a preset position that deflects the supply air away from blowing directly onto room occupants. Vane preset positions will vary depending on the unit's operating mode (cooling or heating).

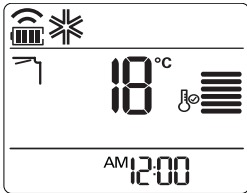
- 1 Press  to turn on the power.
- 2 Press .
 -  is displayed on the screen in cooling, fan and dehumidifying operation.
 -  is displayed on the screen in heating operation.





! NOTE

- This feature is not available in Auto or Auto changeover operation.
- Pressing ,  or  during comfort vane operation will turn off the comfort vane feature.
- When this feature is off, the horizontal vane operates automatically depending on the set mode.

Setting Comfort Sleep mode

Comfort Sleep mode operates the air conditioner automatically to make the comfortable sleep environment.

- 1 Press  to turn the power on.
- 2 Press .

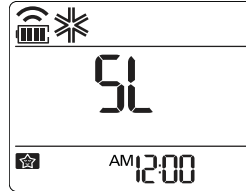

When Comfort sleep mode is set, the air conditioner operates automatically according to room temperature.

When the room temperature is too high to sleep, the vane is swing for quick cooling to help users to fall asleep.

When the room temperature is optimal, the air conditioner adjusts the temperature with an indirect airflow angle of vane.

! NOTE

- The vane stops swing and sets indirect airflow angle, after 30 minutes from start even though the room temperature doesn't decrease to optimal temperature to sleep.
- It is possible that a comfortable sleep environment is different according to the people.

Operating the air conditioner without the remote control

You can use the On/Off button of the indoor unit to operate the air conditioner when the remote control is unavailable. However, the fan speed is set to high.

- 1 Open the front cover.
 - Lift up both sides of the cover slightly.

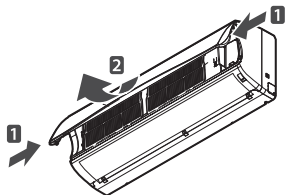

* The feature can be changed according to type of model.

- 2 Press the On/Off button.

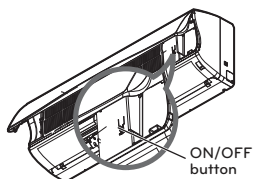

* The feature can be changed according to type of model.

- For cooling and heating models, the operation mode changes, depending on the room temperature.

Room temp.	Set temp.	Operation mode
Below 21°C	24°C	Heating operation
Above 21°C And Below 24°C	23°C	Dehumidifying operation
Above 24°C	22°C	Cooling operation

- For cooling-only models, the temperature is set to 22°C.

Restarting the air conditioner automatically

When the air conditioner is turned on again after a power failure, this function restores the previous settings. This function is a factory default setting.

Disabling auto restart

- 1 Open the front cover.
 - Lift up both sides of the cover slightly.

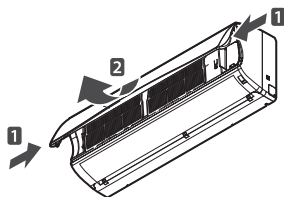

* The feature can be changed according to type of model.

- 2 Press the On/Off button and hold it for 6 seconds.
 - The unit will beep twice and the lamp will blink 6 times.

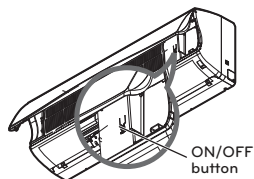

* The feature can be changed according to type of model.

- To re-enable the function, press the On/Off button and hold it for 6 seconds. The unit will beep twice and the blue lamp will blink 4 times.

NOTE

If you press and hold the On/Off button for 3 – 5 seconds instead of 6 seconds, the unit will switch to the test operation. In the test operation, the unit blows out strong air for cooling for 18 minutes and then returns to the factory default settings.

MAINTENANCE

Clean the product regularly to maintain optimal performance and to prevent possible breakdown.

* This may not be provided, depending on the model.

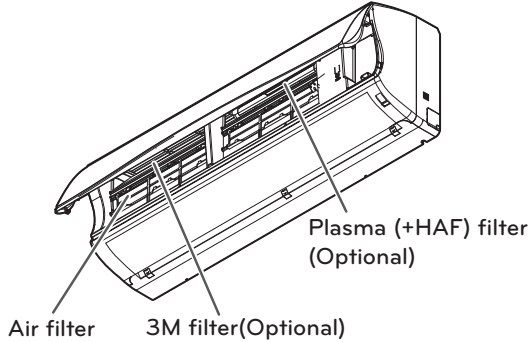

* The feature can be changed according to type of model.

Item	Cleaning interval	Cleaning method
Air filter	2 weeks	See "Cleaning air filter."
3M filter(Optional)	1 months	See "Cleaning 3M filter(Optional)."
Plasma (+HAF) filter*	3 months	See "Cleaning the plasma (+HAF) filter."
Indoor unit surface	Regularly	Use a soft, dry cloth. Do not use bleach or abrasives.
Outdoor unit	Regularly	Use steam to clean the heat exchanger coils and the panel vents (consult with technician).

CAUTION

- Turn off the power and unplug the power cord before you perform any maintenance; otherwise it may cause electric shock.
- Never use water that is hotter than 40°C when you clean the filters. It may cause deformation or discoloration.
- Never use volatile substances when you clean the filters. They may damage the surface of the product.
- Do not washed the 3M filter with water, because the filter can be damaged.

NOTE

- The location and shape of the filters may differ, depending on the model.
- Make sure to clean the heat exchanger coils of the outdoor unit regularly, as dirt collected in the coils may decrease the operational efficiency or increase energy costs.

Cleaning the air filter

Clean the air filter once every 2 weeks or more if necessary.

- 1 Turn off the power and unplug the power cord.
- 2 Open the front cover.
 - Lift up both sides of the cover slightly.

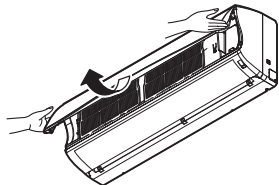

* The feature can be changed according to type of model.

- 3 Hold the knob of the air filter, lift it up slightly and remove it from the unit.

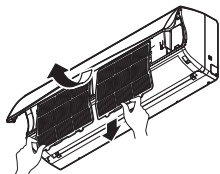

* The feature can be changed according to type of model.

- 4 Clean the filter with a vacuum cleaner or with warm water.
 - If dirt is difficult to remove, wash the filter in lukewarm water with detergent.
- 5 Dry the filter in the shade.

Cleaning 3M filter(Optional)

- 1 Turn off the power and unplug the power cord.
- 2 Open the front cover and remove the air filter (see "Cleaning air filter").
- 3 Pull out the 3M Filter.

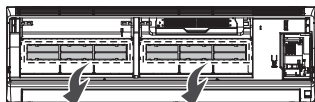

* The feature can be changed according to type of model.

- 4 Use a vacuum cleaner to remove dirt, Do not wash the 3M Filter with water, because the filter can be damaged.

! NOTE

- The location and shape of the filters may differ, depending on the model.
- We suggest changing the 3M Filter every 6 Months.

Cleaning the plasma (+HAF) filter (Optional)

- 1 Turn off the power and unplug the power cord.
- 2 Open the front cover and remove the air filter (see "Cleaning air filter").
- 3 Remove the plasma (+HAF) filter in 10 seconds.

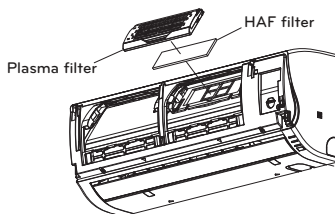

* The feature can be changed according to type of model.

- 4 Use a vacuum cleaner to remove any dirt.
 - If dirt is difficult to remove, wash the filter with lukewarm water.
- 5 Dry the filter in the shade.

* We suggest changing the HAF filter every 2years.

! NOTE

- The location of the filters may differ, depending on the model.
- The plasma filter may not be included in some models.
- If you need more filters, please contact the LG service center. (Refer to the Warranty card.)

TROUBLESHOOTING

Self-diagnosis function

This product has a built-in self-diagnosis function. If an error occurs, the lamp of the indoor unit will blink in 2 second intervals. If this occurs, contact your local dealer or service center.

Before requesting service

Please check the following before you contact the service center. If the problem persists, contact your local service center.

Problem	Possible causes	Corrective action
There is a burning smell and a strange sound coming from the unit.		Turn off the air conditioner, unplug the power cord and contact the service center.
Water leaks from the indoor unit even when the humidity level is low.		
The power cord is damaged or generating excessive heat.		
A switch, a circuit breaker (safety, ground) or a fuse is not operated properly.		
The air conditioner does not work.	The air conditioner is unplugged.	Check whether the power cord is plugged into the outlet.
	A fuse is blown or the power supply is blocked.	Replace the fuse or check if the circuit breaker has tripped.
	A power failure has occurred.	Turn off the air conditioner when a power failure occurs. When the power is restored, wait 3 minutes, and then turn on the air conditioner.
	The voltage is too high or too low.	Check if the circuit breaker has tripped.
	The air conditioner turned off automatically at a preset time.	Press the power button again.

Problem	Possible causes	Corrective action
The air conditioner does not generate cool air.	Air is not circulating properly.	Make sure that there are no curtains, blinds or furniture blocking the front of the air conditioner.
	The air filter is dirty.	Clean the air filter once every 2 weeks. See "Cleaning Air Filter" for more information.
	The room temperature is too high.	In summer, it may take some time to cool indoor air. In this case, select the jet cool operation to cool indoor air quickly.
	Cold air is escaping from the room.	Make sure that no cold air is escaping through ventilation points in the room.
	The desired temperature is higher than the set temperature.	Set the desired temperature to a level lower than the current temperature.
	There is a heating source nearby.	Avoid using a heat generator such as an electric oven or a gas burner while the air conditioner is in operation.
	Air circulation operation is selected.	In the air circulation operation, air blows from the air conditioner without cooling or heating the indoor air. Switch the operation mode to the cooling operation.
It is not possible to adjust the fan speed.	The auto operation, jet operation or dehumidifying operation is selected.	In some operation modes, such as the jet or dehumidifying operation modes, you cannot adjust the fan speed. Select an operation mode in which you can adjust the fan speed.
It is not possible to adjust the temperature.	The air circulation operation or jet operation is selected.	In some operation modes, such as the air circulation or jet operation mode, you cannot adjust the temperature. Select an operation mode in which you can adjust the temperature.

Operation ranges

For Heat & Cool model, heating operation range follows the below table.

Heating operation range	Outdoor temperature
	1 ~ 24 °C

* When the outdoor temperature drops below 0 °C, heating capacity may drop slightly depending on the operation condition.

Details of LG serial No.

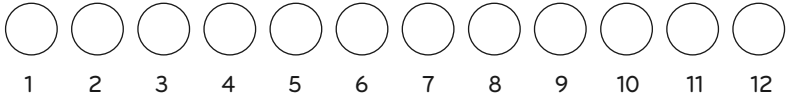

Code	Detail	Code of Model	Meaning
1	Year	0~9 (Digit)	The last digit of year ex) 1997 → 7, 2000 → 0
2,3	Month	01~12 (Digit)	Month ex) March → 03, August → 08
4	Nation	A~Z (Alphabet)	Where manufactured ex) K → Korea, S → Saudi Arabia
5	Product	A~Z (Alphabet)	ex) A → Airconditioner
6,7	Security Code	A~Z (Alphabet)	ex) TS, GH
8~12	Serial No.	0~9 (Digit)	Production Quantity

Main Service Part List

NO	PART NAME
1	COMPRESSOR
2	MOTOR
3	CROSS FLOW FAN
4	MAIN PCB ASSY
5	DISPLAY PCB ASSY
6	REMOCON
7	FRONT GRILLE
8	TRANSFORMER

H. G. IBRAHIM SHAKER COMPANY, LTD.

SERVICE CENTER

- * JEDDAH → P. O. BOX 200, JEDDAH 21411 KINGDOM OF SAUDI ARABIA
TEL NO. : 920006054
- * RIYADH → P. O. BOX 15, RIYADH 11411 KINGDOM OF SAUDI ARABIA
TEL NO. : 920006054
- * AL-KHOBAR → P. O. BOX 78, AL-KHOBAR 31952 KINGDOM OF SAUDI ARABIA
TEL NO. : 920006054
Toll Free No. 8002445454

SPECIFICATION

Model	Indoor	A1828Q NC0	A182SH NC0
	Outdoor	A1828Q UC0	A182SH UC0
Brand		LG Electronics Inc	LG Electronics Inc
Country of origin		Korea	Korea
Type		WALL MOUNTED	WALL MOUNTED
Voltage (V)		230V ~	230V ~
Phase		1 Phase	1 Phase
Hz		60Hz	60Hz
Refrigerant	R410A (kg)	1.4	1.4
Cooling(T1)	Capacity (kW)	5.00	5.00
	Input (kW)	1.48	1.48
	Current (A)	6.6	6.6
	EER (Btu/Watt.hr)	11.53	11.53
Cooling(T3)	Capacity (kW)	4.32	4.32
	Input (kW)	1.78	1.78
	Current (A)	7.9	7.9
	EER (Btu/Watt.hr)	8.28	8.28
Heating(H1)	Capacity (kW)	4.76	4.76
	Input (kW)	1.50	1.50
	Current (A)	6.6	6.6
	COP (W/W)	3.17	3.17
Dimensions	Indoor (W*H*D)	1030*320*245 mm	1030*320*245 mm
		40.5*12.6*9.6 inch	40.5*12.6*9.6 inch
	Outdoor (W*H*D)	870*808*320 mm	870*808*320 mm
		34.25*25.79*12.6 inch	34.25*25.79*12.6 inch
Net Weight	Indoor	13 kg	13 kg
	Outdoor	51.5 kg	51.5 kg
Annual energy consumption (kWh)		3996	3996

* Note : These values come after 20 hours aging(run in) at test condition.