

OWNER'S MANUAL

AIR CONDITIONER

Please read this manual carefully before
operating your set and retain it for future reference.

TYPE : WALL MOUNTED



* M F L 6 8 7 8 1 2 0 3 *

Rev : 01 (01T15)

TIPS FOR SAVING ENERGY

Here are some tips that will help you to minimize the power consumption when you use the air conditioner. You can use your air conditioner more efficiently by referring to the instructions below :

- Do not cool the indoor excessively. This may be harmful for your health and may consume more electricity.
- Block sunlight with blinds or curtains while you are operating the air conditioner.
- Keep doors or windows closed tightly while you are operating the air conditioner.
- Adjust the direction of the air flow vertically or horizontally to circulate indoor air.
- Speed up the fan to cool or warm indoor air quickly, in a short period of time.
- Open windows regularly for ventilation as the indoor air quality may deteriorate if the air conditioner is used for many hours.
- Clean the air filter once every 2 weeks. Dust and impurities collected in the Air filter may block the air flow or weaken the cooling / dehumidifying functions.

For your records

Staple your receipt to this page in case you need it to prove the date of purchase or for warranty purposes. Write the model number and the serial number here:

Model number : _____

Serial number : _____

You can find them on a label on the side of each unit.

Dealer's name : _____

Date of purchase : _____

IMPORTANT SAFETY INSTRUCTIONS

READ ALL INSTRUCTIONS BEFORE USING THE APPLIANCE.

Always comply with the following precautions to avoid dangerous situation and ensure peak performance of you product.



WARNING

It can result in serious injury or death when the directions are ignored.



CAUTION

It can result in minor injury or product damage when the directions are ignored.



WARNING

- Installation or repairs made by unqualified persons can result in hazards to you and others.
- Air conditioner shall be installed in accordance with national wiring regulations.
- The information contained in the manual is intended for use qualified service technician familiar with safety procedures and equipped with the proper tools and test instruments.
- Failure to carefully read and follow all instructions in this manual can result in equipment malfunction, property damage, personal injury and/or death.
- This appliance is not intend for use by persons (including children) with reduced physical, sensory or mental capabilities, or lack of experience and knowledge, unless they have been given supervision or instruction concerning use of the appliance by a person responsible for theirs safety.
- Children should be supervised to ensure that they do not play with the appliance.
- When the power cord is to be replaced, replacement work shall be performed by authorized personnel only genuine replacement parts.

INSTALLATION

- Use a standard circuit breaker and fuse conforming with the rating of the air conditioner. Failure to do so may result in electric shock or product failure.
- Contact an authorized service center when you install or relocate the air conditioner. Failure to do so may result in serious injury or product failure.
- Always use a power plug and socket with a ground terminal. Failure to do so may result in electric shock or product failure.
- Install the panel and the cover of the control box safely. Failure to do so may result in explosion or fire.
- Install a dedicated electric outlet and circuit breaker before you use the air conditioner. Failure to do so may result in electric shock or product failure.
- Do not modify or extend the power cable. If the power cable or cord has scratches or skin peeled off or deteriorated then it must be replaced. It may result in fire or electric shock.
- Be cautious when you unpack or install the air conditioner. Failure to do so may result in serious injury or product failure.
- Do not install the air conditioner on an unstable surface or where there may be a danger of it falling. It may result in death, serious injury, or product failure.

OPERATION

- Do not let the air conditioner run for a long time when the humidity is very high or when a door or window has been left open. Failure to do so may result in product failure.
- Make sure that the power cord is not pulled or damaged while the air conditioner is operating. Failure to do so may result in fire, electric shock, or product failure.
- Do not place any objects on the power cord. It may result in electric shock or product failure.
- Do not turn on or off the air conditioner by plugging in or unplugging the power plug. It may result in fire or electric shock.
- Do not touch, operate or repair the air conditioner with wet hands. It may result in electric shock or product failure.
- Do not place a heater or other heating appliances near the power cable. It may result in fire, electric shock, or product failure.
- Do not allow water to run into the air conditioner. It may result in explosion or fire.
- Do not leave flammable substances such as gasoline, benzene and thinner near the air conditioner. It may result in explosion or fire.
- Do not use the air conditioner for an extended period of time in a small place without ventilation. Ventilate the place regularly. Failure to do so may result in explosion or fire.
- When there is a gas leak, ventilate sufficiently before using the air conditioner again. Failure to do so may result in explosion or fire.
- Unplug the power plug if there is a noise, smell or smoke coming from the air conditioner. Failure to do so may result in explosion or fire.
- Stop operating and close the window in storm or hurricane. If possible remove the product from the window before hurricane arrives.
- Do not touch the electrostatic filter after opening the front grille. Failure to do so may result in electric shock or product failure.
- Contact an authorized service center when the air conditioner is submerged into water due to flooding. Failure to do so may result in explosion or fire.
- Be cautious water could not enter the product.
- Make sure to ventilate sufficiently when this air conditioner and a heating appliance such as a heater are used simultaneously. Failure to do so may result in explosion or fire, serious injury, or product failure.
- Turn the main power off and unplug the power plug when you clean or repair the air conditioner. Failure to do so may result in death, serious injury, or product failure.
- Unplug the power plug when the air conditioner is not used for an extended period of time. Failure to do so may result in product failure.
- For inner cleaning, contact an Authorized Service Center or a dealer.
- Do not use harsh detergent that causes corrosion or damage on the unit. Harsh detergent may also cause failure of product, fire, or electric shock.

 **CAUTION****INSTALLATION**

- Make sure to check if there is a refrigerant leak after you install or repair the air conditioner. Failure to do so may result in product failure.
- Install the drain hose properly for smooth drainage of condensed water. Failure to do so may result in product failure.
- Keep level even when installing the product.
- Install the air conditioner where the noise from the outdoor unit or the exhaust gas will not inconvenience the neighbors. Failure to do so may result in conflict between neighbors.
- When transporting the equipment, there should be at least 2 or more people, or a forklift. It may result in serious injury.
- Do not install the air conditioner where it will be exposed to sea wind (salt spray) directly. It may result in product failure.
- Do not turn on the breaker or power under condition that front panel, cabinet, top cover, control box cover are removed or opened. Otherwise, it may cause fire, electric shock, explosion or death.

OPERATION

- Do not expose people, animals or plants to the cold or hot wind from the air conditioner. It may result in serious injury.
- Do not use the product for special purposes, such as preserving foods, works of art, etc. It is a consumer air conditioner, not a precision refrigeration system. It may result in death, fire or electric shock.
- Do not block the inlet or outlet of air flow. It may result in explosion or product failure.
- Do not use strong cleaning agents or solvents when you clean the air conditioner, or spray water. Use a smooth cloth. It may result in serious injury or product failure.
- Never touch the metal parts of the air conditioner when you remove the air filter. It may result serious injury or product failure.
- Do not place any objects on the air conditioner. It may result in product failure.
- Always insert the filter securely after cleaning. Clean the filter every two weeks or more often if necessary.
- Do not insert hands or other objects through the air inlet or outlet while the air conditioner is operating. It may result in electric shock.
- Do not drink the water drained from the air conditioner. It may result in serious health complications.
- Use a sturdy stool or ladder when you clean, maintain or repair the air conditioner at a height. Failure to do so may result in serious injury or product failure.
- Do not mix the batteries for the remote control with other types of batteries or mix new batteries with used batteries. Failure to do so may result in product failure.
- Do not recharge or disassemble the batteries. Failure to do so may result in explosion, fire or serious injury.
- Stop using the remote control if there is a battery fluid leak. If your cloth or skin is explosion to the battery fluid from a leak, wash it off with clean water. Failure to do so may result in serious injury.
- If you swallow the battery fluid from a leak. Wash out the inside of your mouth thoroughly and then consult a doctor. Failure to do so may result in serious health complications.

CONTENTS

2 TIPS FOR SAVING ENERGY

3 IMPORTANT SAFETY INSTRUCTIONS

7 BEFORE USE

- 7 COMPONENTS
- 7 - INDOOR UNIT TYPE 1
- 7 - INDOOR UNIT TYPE 2
- 8 - OUTDOOR UNIT
- 9 INSERTING BATTERIES
- 9 INSTALLING THE REMOTE CONTROL HOLDER
- 9 OPERATING METHOD

10 USING THE REMOTE CONTROL

- 10 WIRELESS REMOTE CONTROL

11 BASIC FUNCTIONS

- 11 COOLING YOUR ROOM (COOLING OPERATION)
- 11 REMOVING HUMIDITY (DEHUMIDIFYING OPERATION)
- 11 AIRING YOUR ROOM (AIR CIRCULATION OPERATION)
- 11 ADJUSTING THE FAN SPEED
- 12 ADJUSTING THE AIR FLOW DIRECTION
- 12 SETTING THE TIMER
 - 12 - SETTING THE CURRENT TIME
 - 12 - TURNING ON THE AIR CONDITIONER AUTOMATICALLY AT A SET TIME
 - 12 - TURNING OFF THE AIR CONDITIONER AUTOMATICALLY AT A SET TIME
 - 12 - CANCELING THE TIMER SETTING
- 13 SETTING SLEEP MODE

13 ADVANCED FUNCTIONS

- 13 CHANGING ROOM TEMPERATURE QUICKLY (JET COOL) (OPTIONAL)
- 14 INDOOR AIR PURIFICATION (AUTO CLEAN OPERATION)
- 14 DISPLAY SCREEN BRIGHTNESS
- 14 AUTO OPERATION (ARTIFICIAL INTELLIGENCE)
- 15 1 TOUCH SOFT AIR OPERATION (COMFORT VANE OPERATION) (OPTIONAL)
- 15 MOSQUITO AWAY OPERATION
- 16 ACTIVE ENERGY CONTROL OPERATION
- 17 OPERATING THE AIR CONDITIONER WITHOUT THE REMOTE CONTROL
- 17 RESTARTING THE AIR CONDITIONER AUTOMATICALLY
 - 17 - DISABLING AUTO RESTART

18 MAINTENANCE

- 19 CLEANING THE AIR FILTER
- 19 CLEANING ALLERGY FREE FILTER AND TRIPLE FILTER (OPTIONAL)
- 20 CLEANING 3M FILTER (OPTIONAL)

21 TROUBLESHOOTING

- 21 SELF-DIAGNOSIS FUNCTION
- 21 BEFORE REQUESTING SERVICE

BEFORE USE

COMPONENTS

INDOOR UNIT TYPE 1

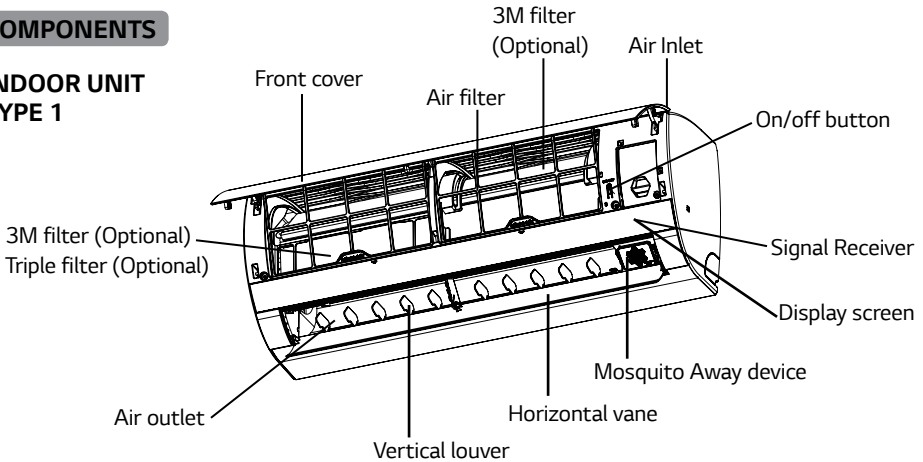

*The feature can be changed according a type of model.

INDOOR UNIT TYPE 2

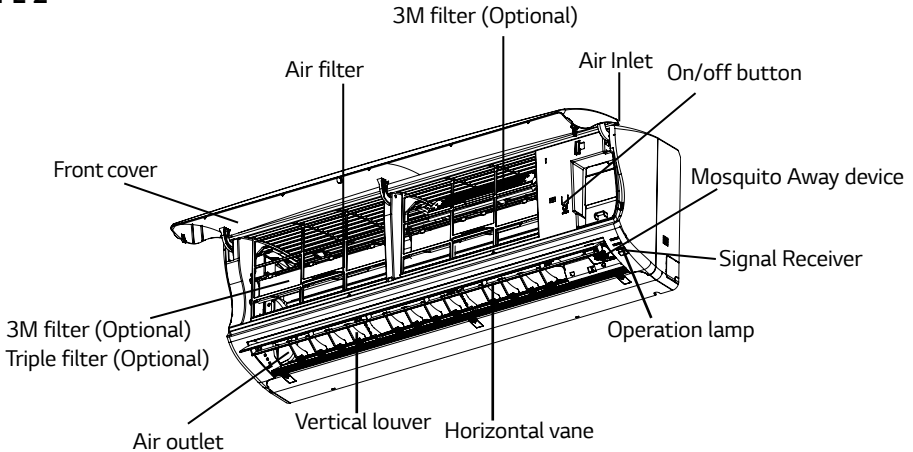

*The feature can be changed according a type of model.

! NOTE

- The number of operation lamps and their locations may vary, depending on the model of the air conditioner.

OUTDOOR UNIT

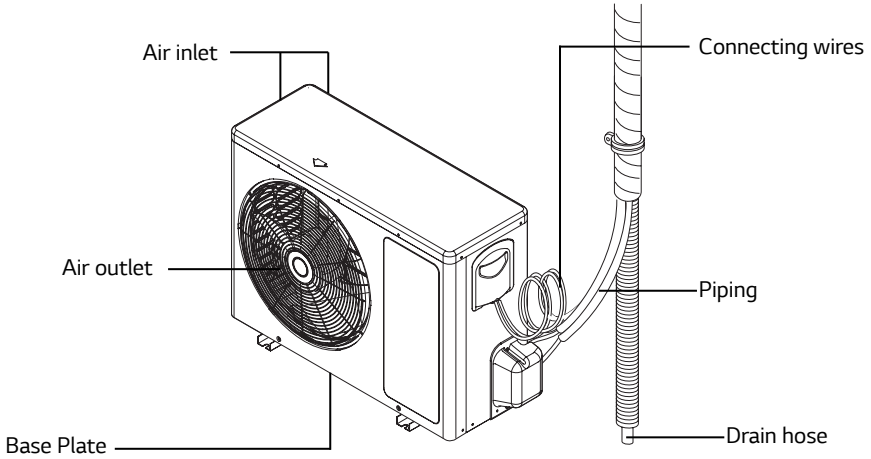

*The feature can be changed according a type of model.

INSERTING BATTERIES

Insert batteries before using the remote control. The battery type used is AAA (1.5 V).

1. Remove the battery cover.

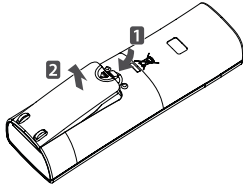

2. Insert the new batteries and make sure that the (+) and (-) terminals of the batteries are installed correctly.

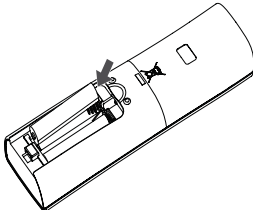

3. Reattach the battery cover.

NOTE

- If the display screen of the remote control starts to fade, replace the batteries.

INSTALLING THE REMOTE CONTROL HOLDER

Install the holder where there is no direct sunlight to protect the remote control.

1. Choose a safe and easily-accessible place.

2. Fix the holder by fastening the 2 screws firmly with a screwdriver.

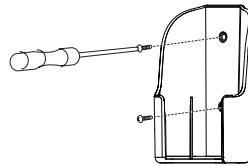

3. Slide the remote control into the holder.

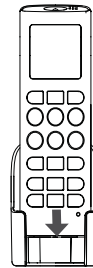

OPERATING METHOD

Point the remote control towards the signal receiver at the bottom of the air conditioner to operate it.

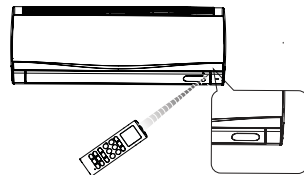

*The feature can be changed according a type of model.

NOTE

- The remote control may operate other electronic devices if pointed towards them. Make sure to point the remote control towards the signal receiver of the air conditioner.
- For proper operation, use a soft cloth to clean the signal transmitter and receiver.

USING THE REMOTE CONTROL

You can operate the air conditioner more conveniently with the remote control.

WIRELESS REMOTE CONTROL

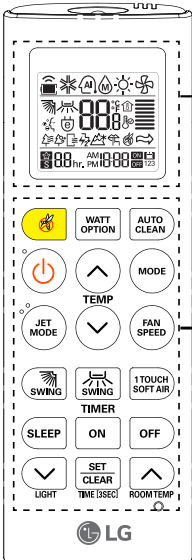



Display screen

Control panel



Control panel	Display screen	Description
		Mosquito Away operation button : Used to start or stop Mosquito Away operation.
		Active energy control button : Select Active energy control Option.
		Auto clean button : Remove moisture and clean inside of the indoor unit when turn off the power.
	-	On/Off button : Turn the power On/Off.
		Temperature adjustment buttons : Adjust the room temperature when cooling.
	 	Operation mode selection button : Select the operation mode. Cooling operation (❄️) Auto operation (Ⓐ) Dehumidifying operation (💧) Air circulation (🌀)
		Jet cool button : Cools down the indoor temperature within a short period of time.
		Indoor fan speed button : Adjust the fan speed.
		Air flow direction button : Adjust the air flow direction vertically or horizontally.
		1 Touch soft air button : To prevent air flow directly to person.
		Sleep mode auto button : Sets the sleep mode auto operation.
		Timer button : Sets the current time and the start / end time.
	-	Light button : Adjusts the brightness of the indoor unit display.
		Temperature display button : Displays the room temperature.
	-	Set/clear button : Sets or cancels functions.
	-	Reset button : Initialize the air conditioner settings.

BASIC FUNCTIONS

COOLING YOUR ROOM (COOLING OPERATION)

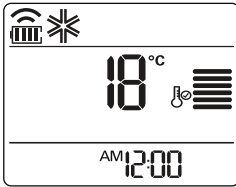

1. Press  to turn on the power.
 2. Press  repeatedly to select the cooling operation.
- ❄️ is displayed on the display screen.



3. Press  or  to set the desired temperature.
- The temperature range is 16°C-30°C

REMOVING HUMIDITY (DEHUMIDIFYING OPERATION)

This mode removes excess moisture from an environment with high humidity or in the rainy season, in order to prevent mold. This mode adjusts the room temperature and the fan speed automatically to maintain the optimal level of humidity.

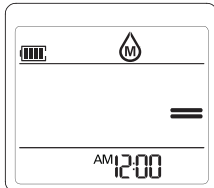

1. Press  to turn on the power.
 2. Press  repeatedly to select the dehumidifying operation.
- 💧 is displayed on the display screen.





! NOTE

- In this mode you cannot adjust the room temperature, as it is adjusted automatically. Also, the room temperature is not displayed on the display screen.

AIRING YOUR ROOM (AIR CIRCULATION OPERATION)

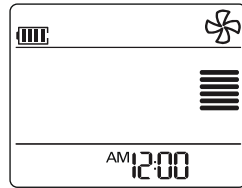





1. Press  to turn on the power.
 2. Press  repeatedly to select the air circulation operation.
- 🌀 is displayed on the display screen.





3. Press  to adjust the fan speed.

ADJUSTING THE FAN SPEED



1. Press  repeatedly to adjust the fan speed.

Remark	Speed
	High
	Medium High
	Medium
	Medium Low
	Low
	Natural wind

ADJUSTING THE AIR FLOW DIRECTION

- To adjust the direction of the air flow vertically, press  change the air flow direction automatically.
- To adjust the direction of the air flow horizontally, press  change the air flow direction automatically.

**NOTE**

- Adjusting the air deflector arbitrarily may cause product failure.
- If you restart the air conditioner, it starts to operate with the previously set direction of air flow, so the air deflector may not match the icon displayed on the remote control. When this occurs, press  or  to adjust the direction of the air flow again.



SETTING THE TIMER

You can use the timer function to save energy and to use the air conditioner more efficiently.

SETTING THE CURRENT TIME

- Press  and hold it for longer than 3 seconds.
 - The AM/PM icon flickers at the bottom of the display screen.





- Press  or  to select the minutes.
- Press  to finish.

TURNING ON THE AIR CONDITIONER AUTOMATICALLY AT A SET TIME

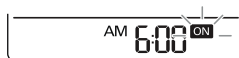
- Press 
 - The icon below flickers at the bottom of the display screen.





- Press  or  to select the minutes.
- Press  to finish.
- When setting the timer, current time and ON icon are displayed on the display screen indicating that the desired time is set.

TURNING OFF THE AIR CONDITIONER AUTOMATICALLY AT A SET TIME

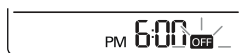
- Press 
 - The icon below flickers at the bottom of the display screen.









- Press  or  to select the minutes.
- Press  to finish.
- When setting the timer, current time and OFF icon are displayed on the display screen indicating that the desired time is set.

CANCELING THE TIMER SETTING

- Press  to cancel all timer setting.

SETTING SLEEP MODE

Use the sleep mode to turn off the air conditioner automatically when you go to sleep.

1. Press  to turn on the power.
 2. Press .
 3. Press  or  to select the hour (Up to 7 hours).
 4. Press  to finish.
-  is displayed on the display screen.

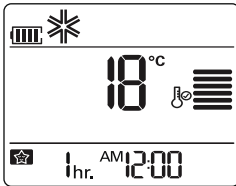



! NOTE

- In the Cooling and Dehumidifying modes, the temperature increases by 1°C (2°F) after 30 minutes and by a further 1°C (2°F) after another 30 minutes for a more comfortable sleep. The temperature increases with up to 2°C (4°F) from the preset temperature.

ADVANCED FUNCTIONS

The air conditioner offers some additional advanced functions.

CHANGING ROOM TEMPERATURE QUICKLY (JET COOL) (OPTIONAL)

1. Press  to turn on the power.
 2. Press .
-  is displayed on the display screen.

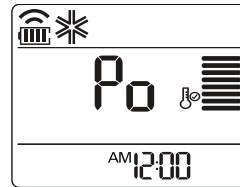



- In jet cooling mode, strong air blows out at a temperature of 18°C for 30 minutes.

! NOTE

- Powerful Cooling enable in Cooling/ Fan / Dehumidifying/Artificial intelligent.
- This function may not be supported, depending on the model.

**INDOOR AIR PURIFICATION
(AUTO CLEAN OPERATION)**

In the cooling and dehumidifying operations, moisture is generated inside the indoor unit. Use the auto cleaning function to remove such moisture.

1. Press  and hold it for longer than 3 seconds.
-  is displayed on the display screen.

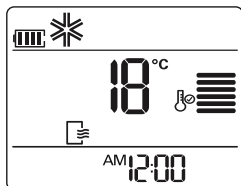

- If you turn off the power, the fan operates for 30 minutes and clean the inside of the indoor unit.

! NOTE

Some buttons cannot be used while the auto cleaning function is in operation.





DISPLAY SCREEN BRIGHTNESS

You can adjust the brightness of the indoor unit display screen.

1. Press  to turn on/off the lamp on the front cover.

**AUTO OPERATION
(ARTIFICIAL INTELLIGENCE)**

In this mode, the fan speed and the temperature adjust automatically, based on the room temperature.

1. Press  to turn on the power.
2. Press  repeatedly to select auto operation.
3. Press  or  to select the desired operation code if the temperature is higher or lower than the desired temperature.
-  is displayed on the display screen.

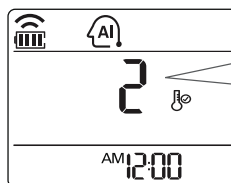





Code	Description
2	Cool
1	Cool slightly
0	Maintain room temperature
-1	Heat slightly
-2	Heat

! NOTE

- In this mode, you cannot adjust the fan speed, but you can set the air deflector to rotate automatically.
- This function may not be supported, depending on the model.



1 TOUCH SOFT AIR OPERATION (COMFORT VANE OPERATION) (OPTIONAL)

The comfort vane option conveniently sets the vane to a preset position that deflects the supply air away from blowing directly onto room occupants.

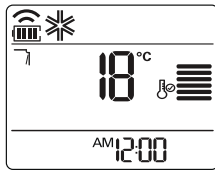
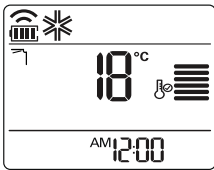
1. Press  to turn on the power.
 2. Press  repeatedly and select the desired direction.
-  or  is displayed on the display screen.





! NOTE

- Pressing  or  during comfort vane operation will turn off the comfort vane feature.
- Pressing  during comfort vane operation will turn off the comfort vane feature and set up the auto swing of vertical direction.
- When this feature is off, the horizontal vane operates automatically depending on the set mode.

MOSQUITO AWAY OPERATION

Mosquito Away is a device to radiate frequency mosquitoes don't like.

1. Press .
- Mosquito Away LED Light up on the display.
2. Press  again to finish.





! NOTE

- You can use this function by pressing  without turning the air conditioner on. (In this case, You cannot use some buttons regarding to air flow.)
- At this time a horizontal vane moves and the fan speed low.
- This function may not be supported depending on the model.
- The Mosquito Away performance can be different depending on the customer's environment.



ACTIVE ENERGY CONTROL OPERATION

This mode reduces power input from rated power input during the cooling mode.

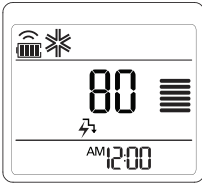

*Active energy control operation : 80% / 60% / 40% compared to the rated power input

1. Press  to turn on the power.
2. Press  repeatedly to select the cooling operation.
3. Press  to select 80
- 80 and  are displayed on the screen.

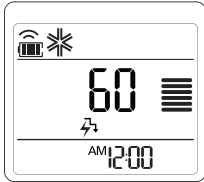

4. Press  one more time to select 60
- 60 and  are displayed on the screen.



5. Press  one more time to select 40
- 40 and  are displayed on the screen.

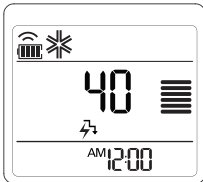

Displayed on the Indoor unit
(The display on the unit depending on the model)

Version 1

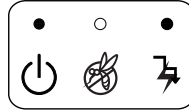

Version 2

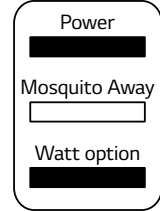

6. Press one more time to return to the normal cooling operation.

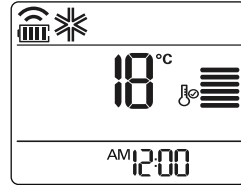

Displayed on the Indoor unit
(The display on the unit depending on the model)

Version 1

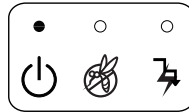

Version 2

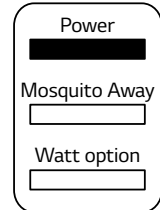

NOTE

- Due to 'Active energy control' inadequate cooling capacity may occur.
 - Cooling capacity for 'Active energy control': Approximately 80% / 60% / 40% of rated cooling capacity.
 - You can set desired temperature in 'Active energy control operation'. Setting temperature will be displayed for 5 seconds and then return to the display 80%/60%/40%.
 - 'Active energy control operation' is memorized.
- Ex) In case of restarting the air-conditioner during 'Active energy control operation 80%', It operates 'Active energy control operation 80%' automatically.

OPERATING THE AIR CONDITIONER WITHOUT THE REMOTE CONTROL

You can use the on/off button of the indoor unit to operation the air conditioner when the remote control is unavailable. However, the fan speed is set to high.

1. Open the front cover.
 - Lift up both side of the cover slightly.

TYPE 1

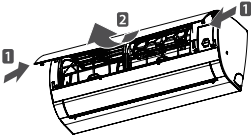

TYPE 2

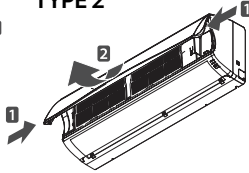

*The feature can be changed according a type of model.

2. Press the On/Off button.

TYPE 1

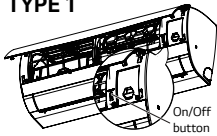

TYPE 2

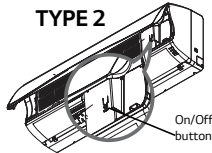

*The feature can be changed according a type of model.

- For cooling and heating model, the operation mode changes, depending on the room temperature.

Room Temp.	Set Temp.	Operation mode
Below 21°C	24°C	Heating operation
Above 21°C and below 24°C	23°C	Dehumidifying operation
Above 24°C	22°C	Cooling operation

- For cooling only model, the temperature is set to 22°C.

RESTARTING THE AIR CONDITIONER AUTOMATICALLY

When the air conditioner is turned on again after a power failure, this function restores the previous settings. This function is a factory default setting.

DISABLING AUTO RESTART

1. Open the front cover.
 - Lift up both side of the cover slightly.

TYPE 1

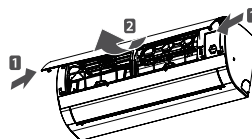

TYPE 2

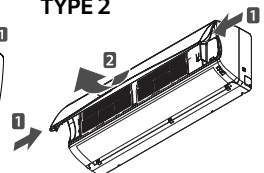

*The feature can be changed according a type of model.

2. Press the On/Off button and hold it for 6 seconds.

- The unit will beep twice and the lamp will blink twice 4 times.

TYPE 1

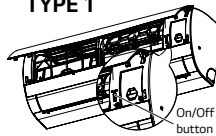

TYPE 2

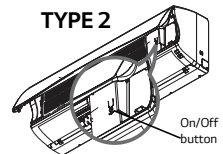

*The feature can be changed according a type of model.

- To re-enable the function, press the On/Off button and hold it for 6 seconds. The unit will beep twice and the lamp will blink 4 times.

NOTE

- If you press and hold the On/Off button for 3-5 seconds, the unit will switch to the test operation. In the test operation, the unit blows out strong air for cooling for 18 minutes and then returns to the factory default setting.

MAINTENANCE

Clean the product regularly to maintain optimal performance and to prevent possible breakdown.

TYPE 1

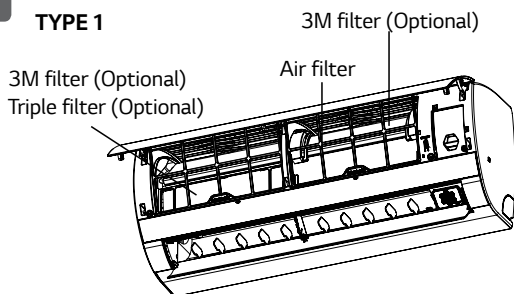

TYPE 2

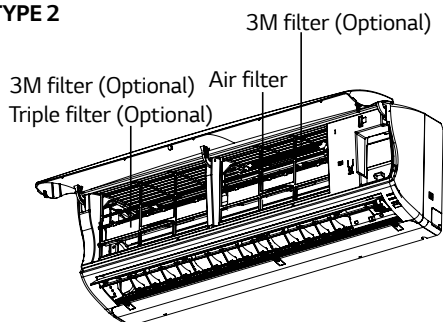

* The feature can be changed according a type of model.

Item	Cleaning interval	Cleaning method
Air filter	2 weeks	See "Cleaning Air filter"
3M filter	1 month	See "Cleaning 3M filter"
Triple filter	3 months	See "Cleaning Allergy free filter and Triple filter"
Allergy free filter	3 months	See "Cleaning Allergy free filter and Triple filter"
Plasma filter	1 month	See "Cleaning Plasma filter"
Indoor unit surface	Regularly	Use a soft, dry cloth. Do not use bleach or abrasives.
Outdoor unit	Regularly	Use steam to clean the heat exchanger coils and the panel vents (consult with technician).

⚠ CAUTION

- Turn off the power and unplug the power cord before you perform any maintenance; otherwise it may cause electric shock.
- Never use water that is hotter than 40°C when you clean the filters. It may cause deformation or discoloration.
- Never use volatile substances when you clean the filters. They may damage the surface of the product.
- Do not washed the 3M filter with water, because the filter can be damaged.

! NOTE

- The location and shape of the filter may differ, depending on the model.
- Make sure to clean the heat exchanger coils of the outdoor unit regularly, as dirt collected in the coil may decrease the operational efficiency or increase energy costs.

CLEANING THE AIR FILTER

Cleaning the Air filter once every 2 weeks or more if necessary.

1. Turn off the power and unplug the power cord.
2. Open the front cover.
- Lift up both sides of the cover slightly.

TYPE 1

TYPE 2

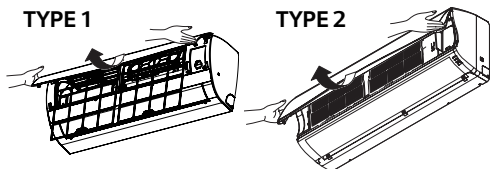

* The feature can be changed according a type of model.

3. Hold the knob of the Air filter, lift it up slightly and remove it from the unit.

TYPE 1

TYPE 2

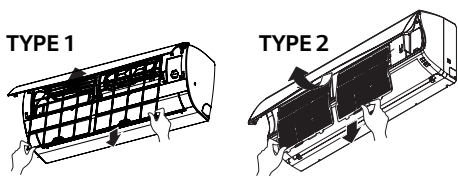

* The feature can be changed according a type of model.

4. Clean the filter with a vacuum cleaner or with warm water.
- If dirt is difficult to remove, wash the filter in lukewarm water with detergent.
5. Dry the filter in the shade.

! NOTE

- For inner cleaning, contact an Authorized Service center or a dealer. Do not use harsh detergent that causes corrosion or damage on the unit. Harsh detergent may also cause failure of product, fire, or electric shock.

CLEANING ALLERGY FREE FILTER AND TRIPLE FILTER (OPTIONAL)

1. Turn off the power and unplug the power cord.
2. Open the front cover and remove Air filter (See "Cleaning Air filter").
3. Pull out the Allergy free filter or Triple filter.

TYPE 1

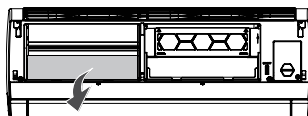

TYPE 2

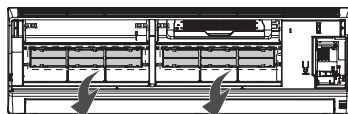

* The feature can be changed according a type of model.

4. Dry the filter in direct sunlight for 2 hours.

! NOTE

- The location and shape of the filters may differ, depend on the model.

CLEANING 3M FILTER (OPTIONAL)

Clean the filter once every 1 months and change the new filter once every 6 months.

1. Turn off the power and unplug the power cord.
2. Open the front cover and remove Air filter. (See "Cleaning Air filter").
3. Pull out 3M filter.

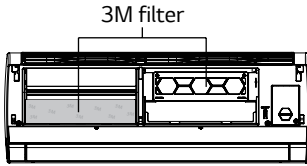
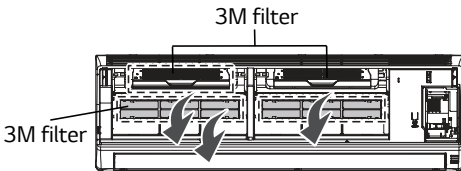
TYPE 1**TYPE 2**

* The feature can be changed according a type of model.

4. Use a vacuum cleaner to remove any dirt. Do not wash the filter with water may be makes damage to the filter.

**NOTE**

- The location and shape of the filters may differ, depend on the model.

TROUBLESHOOTING

SELF-DIAGNOSIS FUNCTION

This product has a built-in self-diagnosis function. If an error occurs, the lamp of the indoor unit will blink in 2 second intervals. If this occurs, contact your local dealer or service center.

BEFORE REQUESTING SERVICE

Please check the following before you contact the service center. If the problem persists, contact your local service center.

Problem	Possible causes	Corrective action
There is a burning smell and a strange sound coming from the unit.	-	Turn off the air conditioner, unplug the power cord and contact the service center.
Water leaks from the indoor unit even when the humidity level is low.		
The power cord is damaged or generating excessive heat.		
A switch, a circuit breaker (safety, ground) or a fuse is not operated properly.		
The air conditioner does not works.	The air conditioner is unplugged.	Check whether the power cord is plugged into the outlet.
	A fuse is blown or the power supply is blocked.	Replace the fuse or check if the circuit breaker has tripped.
	A power failure has occurred.	Turn off the air conditioner when a power failure occurs. When the power is restored, wait 3 minutes, and then on the air conditioner.
	The voltage is too high or too low.	Check if the circuit breaker has tripped.
	The air conditioner turned off automatically at a preset time.	Press the power button again.

Problem	Possible causes	Corrective action
The air conditioner does not generate cool air.	Air is not circulating properly.	Make sure that there are no curtains, blinds or furniture blocking the front of the air conditioner.
	The Air filter is dirty.	Clean the Air filter once every 2 weeks. See "Cleaning Air filter" for more information.
	The room temperature is too high.	In summer, it may take some time to cool indoor air. In this case, select the jet cool operation to cool indoor air quickly.
	Cold air is escaping from the room.	Make sure that no cold air is escaping through ventilation points in the room.
	The desired temperature is higher than the set temperature.	Set the desired temperature to a level lower than the current temperature.
	There is a heating source nearby.	Avoid using a heat generator such as an electric oven or a gas burner while the air conditioner is in operation.
	Air circulation operation is selected.	In the air circulation operation, air blows from the air conditioner without cooling or heating the indoor air. Switch the operation mode to the cooling operation.
It is not possible to adjust the fan speed.	The auto operation, jet operation or dehumidifying operation is selected.	In some operation modes, such as the jet or dehumidifying operation modes, you cannot adjust the fan speed. Select an operation mode in which you can adjust the fan speed.
It is not possible to adjust the temperature.	The air circulation operation or jet operation is selected.	In some operation modes, such as the air circulation or jet operation mode, you cannot adjust the temperature. Select an operation mode in which you can adjust the temperature.

NOTE

