



ENGLISH

Vietnamese

# OWNER'S MANUAL

# SXS

# REFRIGERATOR

Please read this guide thoroughly before operating and keep it handy for reference at all times.



## Table of contents

|                                   |   |    |
|-----------------------------------|---|----|
| <b>Introduction</b>               | Entry   | 4  |
|                                   | Important safety instruction  | 4  |
|                                   | Important safety instruction  | 5  |
|                                   | Identification of parts   | 13 |
| <b>Installation</b>               | Where to install  | 14 |
|                                   | Door removal  | 15 |
|                                   | Door replacement  | 16 |
|                                   | Height adjustment   | 16 |
|                                   | When the freezer door does not align with the height of the refrigerator door | 16 |
| <b>Operation</b>                  | Starting  | 17 |
|                                   | Adjusting the temperatures and functions                                      | 17 |
|                                   | Refreshment center (Applicable to some models only)                           | 20 |
|                                   | Ice making  | 21 |
|                                   | Egg box (Applicable to some models only)                                      | 21 |
|                                   | Shelf   | 22 |
|                                   | Deodorizer (Applicable to some models only)                                   | 22 |
| <b>Suggestion on food storage</b> | Location of foods   | 23 |
|                                   | Storing foods   | 24 |
| <b>Care and maintenance</b>       | How to dismantle parts  | 25 |
|                                   | General information   | 26 |
|                                   | Cleaning  | 26 |
|                                   | Trouble shooting  | 27 |
|                                   | It is normal...   | 31 |
|                                   | <b>Smart Diagnosis (Applicable to some models only)</b>                       | 32 |

## Entry

**The model and serial numbers are found on the inner case or back of refrigerator compartment of this unit. These numbers are unique to this unit and not available to others. You should record requested information here and retain this guide as a permanent record of your purchase. Staple your receipt here.**

Date of purchase : \_\_\_\_\_  
Dealer purchased from : \_\_\_\_\_  
Dealer address : \_\_\_\_\_  
Dealer phone no. : \_\_\_\_\_  
Model no. : \_\_\_\_\_  
Serial no. : \_\_\_\_\_

## Important safety instruction

Before it is used, this refrigerator must be properly installed and located in accordance with the installation instructions in this document.

When moving your appliance away from the wall, be careful not to roll over the power cord or to damage it in any way.

After your refrigerator is in operation, do not touch the cold surfaces in the freezer compartment, particularly when your hands are damp or wet. Skin could adhere to these extremely cold surfaces.

Unplug the power cord from the power outlet for cleaning or other requirements. Never touch it with wet hands because you can get an electric shock or be hurt.

Never place glass products in the freezer because they may be broken due to expansion when their contents are frozen.

Never allow your hands within the ice storage bin of the automatic ice maker. You could be hurt by the operation of the automatic ice maker.

The appliance is not intended for use by young children or infirm persons without supervision.

If possible, connect the refrigerator to its own individual electrical outlet to prevent it and other appliances or household lights from causing an overload that could cause a power outage.

The refrigerator-freezer should be so positioned that the supply plug is accessible for quick disconnection when accident happens.

If the supply cord is damaged, it must be replaced by the manufacturer or its service agent or a similarly qualified person in order to avoid a hazard.



**Don't use an extension cord**

**Accessibility of Supply Plug  
Supply Cord Replacement**





# Important safety instruction

## BASIC SAFETY PRECAUTIONS

This guide contains many important safety messages. Always read and obey all safety messages.

 This is the safety alert symbol. It alerts you to safety messages that inform you of hazards that can kill or hurt you or others or cause damage to the product. All safety messages will be preceded by the safety alert symbol and the hazard signal word DANGER, WARNING, or CAUTION. These words mean:

 **DANGER** You will be killed or seriously injured if you don't follow instructions.

 **WARNING** You can be killed or seriously injured if you don't follow instructions.

 **CAUTION** Indicates an imminently hazardous situation which, if not avoided, may result in minor or moderate injury, or product damage only.

All safety messages will identify the hazard, tell you how to reduce the chance of injury, and tell you what can happen if the instructions are not followed.

## WARNING

To reduce the risk of fire, electric shock, or injury to persons when using your product, basic safety precautions should be followed, including the following. Read all instructions before using this appliance.

### 1. When connecting the power

#### The dedicated outlet should be used.

- Using several devices at one outlet may cause fire.
- The electric leakage breaker may damage food and the dispenser may be leaked.

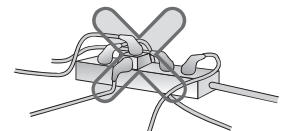

Do not allow the power plug to face upward or to be squeezed at the back of the refrigerator.

Water may be flown into or the plug may be damaged, which causes fire or electric shock.

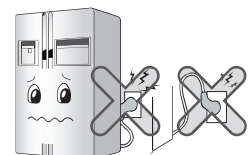

Do not allow the power cord bent or pressed by the heavy object to be damaged.

It may damage the power cord to cause fire or electric shock.

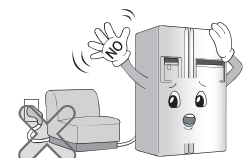

Do not extend or modify the length of the power plug.  
It causes electric shock or fire by the electric damage of the power cord or others.

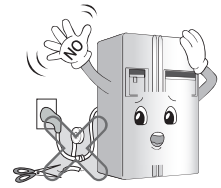

Unplug the power plug when cleaning, handling or replacing the interior lamp of the refrigerator.

- It may cause electric shock or injury.
- When replacing the interior lamp of the refrigerator, make sure that the rubber ring for preventing the electric spark within the socket is not taken off.

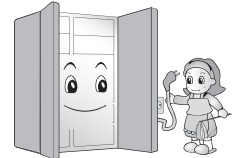

Do not pull out the cord or touch the power plug with wet hands.

- It may cause electric shock or injury.

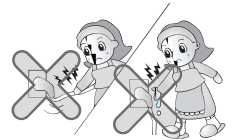

Remove water or dust from the power plug and insert it with the ends of the pins securely connected.

Dust, water or unstable connection may fire or electric shock.

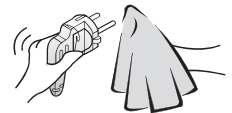

Make sure of grounding.

Consult a qualified electrician or service person if the grounding instructions are not completely understood, or if you have doubts on whether the appliance is properly grounded.

The incorrect grounding may cause breakdown and electric shock.

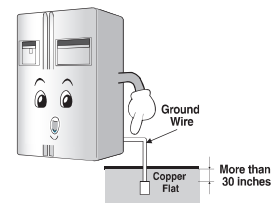

When the power cord or the power plug is damaged or the holes of the outlet are loosed, do not use them.

It may cause electric shock or short circuit to make fire.

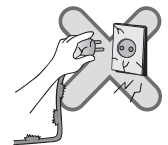

## 2. When using the refrigerator

Do not place the heavy object or the dangerous object (container with liquid) on the refrigerator.

It may be dropped to cause injury, fire or electric shock when opening or closing the door.



Do not install the refrigerator in the wet place or the place which water or rain splashes.

Deterioration of insulation of electric parts may cause electric leakage.

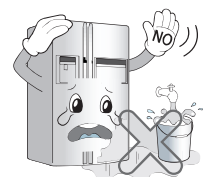

**Do not cling to the door or the shelves of the door or the home bar of the freezer or the cool chamber.**

It may make the refrigerator fallen down or damage the hands. Especially, do not allow the children to do the above.

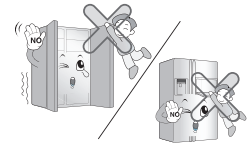

**Do not use or store inflammable materials ether, benzene, alcohol, medicine, LP gas, spray or cosmetics near or in therefrigerator.**

It may cause explosion or fire.

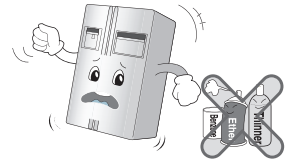

**Do not use drier to dry the inside,nor light a candle to remove odor.**

It may cause explosion or fire.

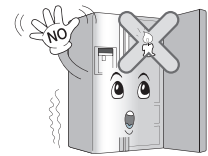

**Do not insert the hands into the ice bucket or the ice dispenser.  
(only for the model with the dispenser).**

Operating the ice maker may cause injury.



**Do not store the medicine or the academic materials at the refrigerator.**

When the material with the strict temperature control is stored, it may be deteriorated or it may make an unexpected reaction to cause any risk.

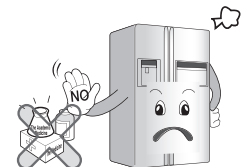

**Do not use the combustibile spray near the refrigerator.**

Do not store explosive substances such as aerosol cans with a flammable propellant in this appliance. It may cause fire.

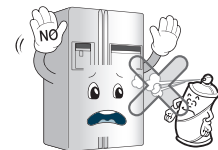

**Install in places away from the fire such as the place where flammable gas is lesked.**

It may cause fire.

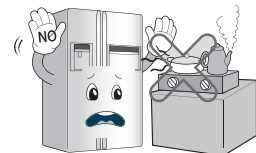

**Supply the automatic ice maker with drinkable water only (only for the model with the dispenser).**

Otherwise, it may cause any risk.

Connect to potable water supply only.

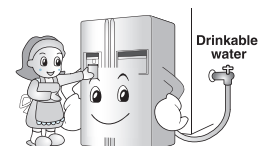

**Do not place flower vase, cup, cosmetics, medicine or any container with water on the refrigerator.**

It may cause fire, electric shock or injury by dropping down.

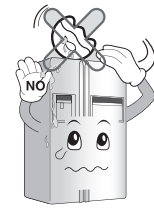

**Use the submerged refrigerator after checking it.**

It may cause electric shock or fire.

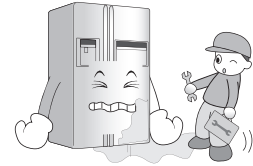

**When gas is leaked, do not touch the refrigerator or the outlet and ventilate the room immediately.**

- The explosion by spark may cause fire or burn.
- Because this refrigerator uses natural gas (R600a) as the environment-friendly refrigerant, even a small amount (80~90g) is combustible. When the gas is leaked by the severe damage during delivering, installing or using the refrigerator, any spark may cause fire or burn. (Only for the model with the R600a.)

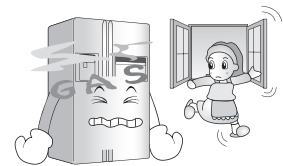

**Do not move refrigerator while the compressor is operating.**

Compressor may occur a temporary rattling noise. (This is normal and will not impact on the performance or the life of the compressor. The rattling will stop after the refrigerator comes to a rest.)

**Do not spray water at the outside or the inside of the refrigerator or do not clean it with benzene or thinner.**

Deterioration of insulation of electric parts may cause electric shock or fire.

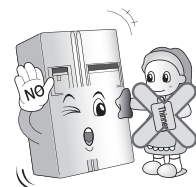

**When any strange smell or smoke is detected from the refrigerator, disconnect the power plug immediately and contact to the service center.**

It may cause fire.



**Do not allow any person except the qualified engineer to disassemble, repair or alter the refrigerator.**

It may cause injury, electric shock or fire.

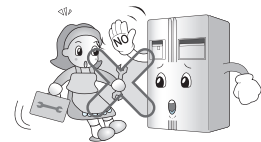

**Do not use the refrigerator for non-domestic purpose (storing medicine or testing material, using at the ship, etc.).**

It may cause an unexpected risk such as fire, electric shock, deterioration of stored material or chemical reaction.

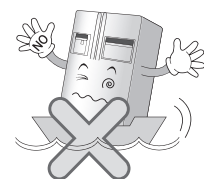

## 2. When using the refrigerator

When disposing the refrigerator, remove the packing materials from the door or take off the doors but leave the shelves in place so that children may not easily climb inside.

It may cause to lock out the child.



Install the refrigerator on the solid and level floor.

Installing it on the unstable place may cause death by falling down the refrigerator when opening or closing the door.

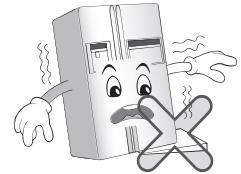

Do not insert the hands or the metal stick into the exit of cool air, the cover, the bottom of the refrigerator, the heatproof grill (exhaust hole) at the backside.

It may cause electric shock or injury.



When you want to dispose the refrigerator, contact to the down-block office.

When you want to dispose the large living waste such as electric home appliance and furniture, you'd better contact the local down-block office.

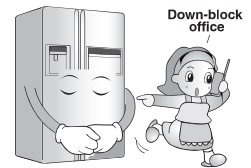

## CAUTION

Violating this direction may cause injury or damage house or furniture. Always be careful, please.

Do not touch food or containers at the freezer with wet hands.

It may cause frostbite.

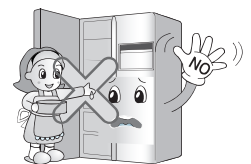

Do not put ice in thin crystal cup or ceramic ware.

It may break cup or ceramic ware to cause injury.

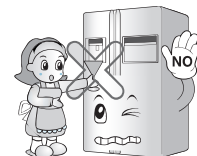

When the electricity is off, remove ice from the ice bucket (only for the model with the dispenser).

The long-time power failure may thaw ice to damage the floor. When the long-time power failure is expected, remove ice from the ice bucket.

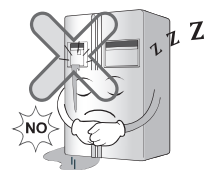

Wait for 5 minutes or longer when reconnecting the plug.  
It may cause the operation of the freezer to fail.



Do not put bottle in the freezer.  
It may freeze the contents to break the bottle to cause injury.



Pull out the power plug not by grasping the cord but the plug of its end.  
It may cause electric shock or short circuit to fire.



Do not install the refrigerator in the wet place or the place which water or rain splashes.  
Deterioration of insulation of electric parts may cause electric leakage.

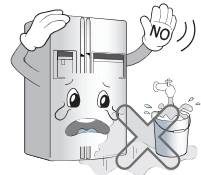

Do not insert the hands into the bottom of the refrigerator.  
The iron plate of the bottom may cause injury.



Carry the refrigerator with the handle bar at the bottom of the front and the top of the rear.  
Otherwise, your hands may be slipped to cause injury.  
Because the product is heavy, carrying it alone may hurt people or accidents may occur.

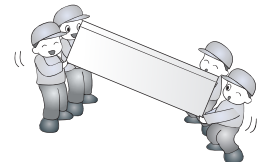

Because opening or closing the door of the refrigerator may cause injury to the person around it, be careful, please.  
Opening or closing the door may cause feet or hands to be caught in the chink in door or the child to be get hurt by the corner.

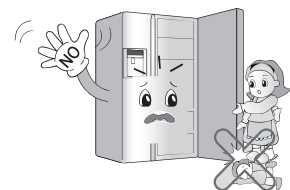

Do not put any living animal in the refrigerator.

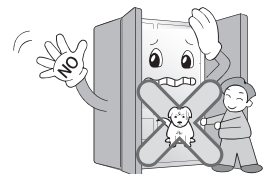

## WARNING

### 1. When connecting the power

Prevent the power cord from being squeezed or imprinted if the refrigerator is pushed in after the power plug is extracted during the installation.

When moving your appliance away from the wall, be careful not to roll over the power cord or to damage it in any way.

It becomes the cause of fire or electric shock.

Be sure to use grounded exclusive proper voltage consent for the power plug.

It becomes the cause of fire.

### 2. When using the refrigerator

Prevent children from entering the product.

It may endanger the life of a child if the child enters the refrigerator.

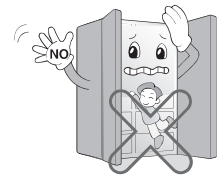

Opening and closing the door of the refrigerator vigorously may cause the stored food in the refrigerator basket to fall by shock and hurt the foot, so take precautions.

Do not put heavy things on the Home Bar.  
(Only for the models with the Home Bar)

Falling objects may hurt people.

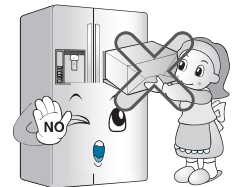

In case of thunder and lightning, or not in use for a long period of time, detach the power plug.

There is a danger of electric shock or fire.

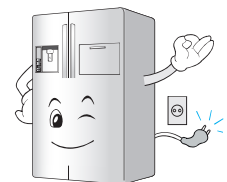

## CAUTION

Do not insert the hands into the ice bucket or the ice dispenser.

Operating the ice maker may cause injury.

Do not remove the cover of the automatic ice maker.  
(Only for the models with automatic ice maker)

The operation mechanic parts of the ice maker may hurt people.



Do not place the food in disorder inside the refrigerator.

The food may fall during opening and closing the door of the refrigerator and hurt people.







 **CAUTION**

This appliance can be used by children aged from 8 years and above and persons with reduced physical, sensory or mental capabilities or lack of experience and knowledge if they have been given supervision or instruction concerning use of the appliance in a safe way and understand the hazards involved.  
Children shall not play with the appliance.  
Cleaning and user maintenance shall not be made by children without supervision.

 **WARNING**

If LED lamp is damaged, it should be replaced by the service center in stead of on your own.

 **WARNING**

-  Keep ventilation openings, in the appliance enclosure or in the built-in structure, clear of obstruction.
-  Do not use mechanical devices or other means to accelerate the defrosting process, other than those recommended by the manufacturer.
-  Do not damage the refrigerant circuit.
-  Do not use electrical appliances inside the food storage compartments of the appliance, unless they are of the type recommended by the manufacturer.
-  The refrigerant and insulation blowing gas used in the appliance require special disposal procedures. When disposal, please consult with service agent or a similarly qualified person.



**This appliance contains a small amount of isobutane refrigerant (R600a), natural gas with high environmental compatibility, but it is also combustible. When transporting and installing the appliance, care should be taken to ensure that no parts of the refrigerating circuit are damaged. Refrigerant squirting out of the pipes could ignite or cause an eye injury. If a leak is detected, avoid any naked flames or potential sources of ignition and air the room in which the appliance is standing for several minutes.**

In order to avoid the creation of a flammable gas air mixture if a leak in the refrigerating circuit occurs, the size of the room in which the appliance may be sited depends on the amount of refrigerant used. The room must be 1m<sup>2</sup> in size for every 8g of R600a refrigerant inside the appliance. The amount of refrigerant in your particular appliance is shown on the identification plate inside the appliance. Never start up an appliance showing any signs of damage. If in doubt, consult your dealer.



**Child entrapment warning**

**⚠️ WARNING** : Risk of child entrapment.

Before you throw away your old refrigerator or freezer:  
Take off the doors but leave the shelves in place so that children may not easily climb inside.

**Don't store**

Don't store or use gasoline or other flammable vapor and liquids in the vicinity of this or any other appliance.

**Grounding (Earthing)**

In the event of an electric short circuit, grounding (earthing) reduces the risk of electric shock by providing an escape wire for the electric current.

In order to prevent possible electric shock, this appliance must be grounded. Improper use of the grounding plug can result in an electric shock. Consult a qualified electrician or service person if the grounding instructions are not completely understood, or if you have doubts on whether the appliance is properly grounded.

**Identification of parts**

**Type-1**

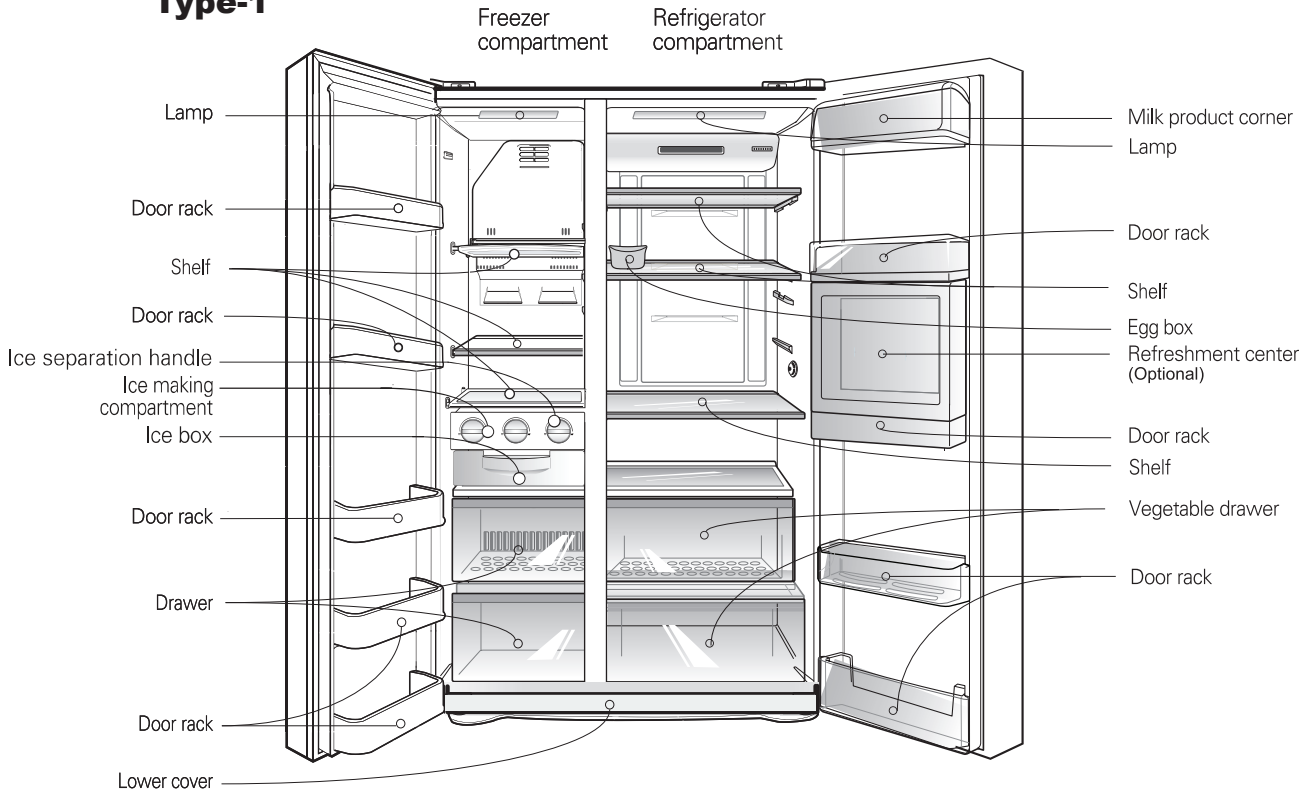

**NOTE**

- Parts, features, and options vary by model. Your model may not include every option.

## Type-2

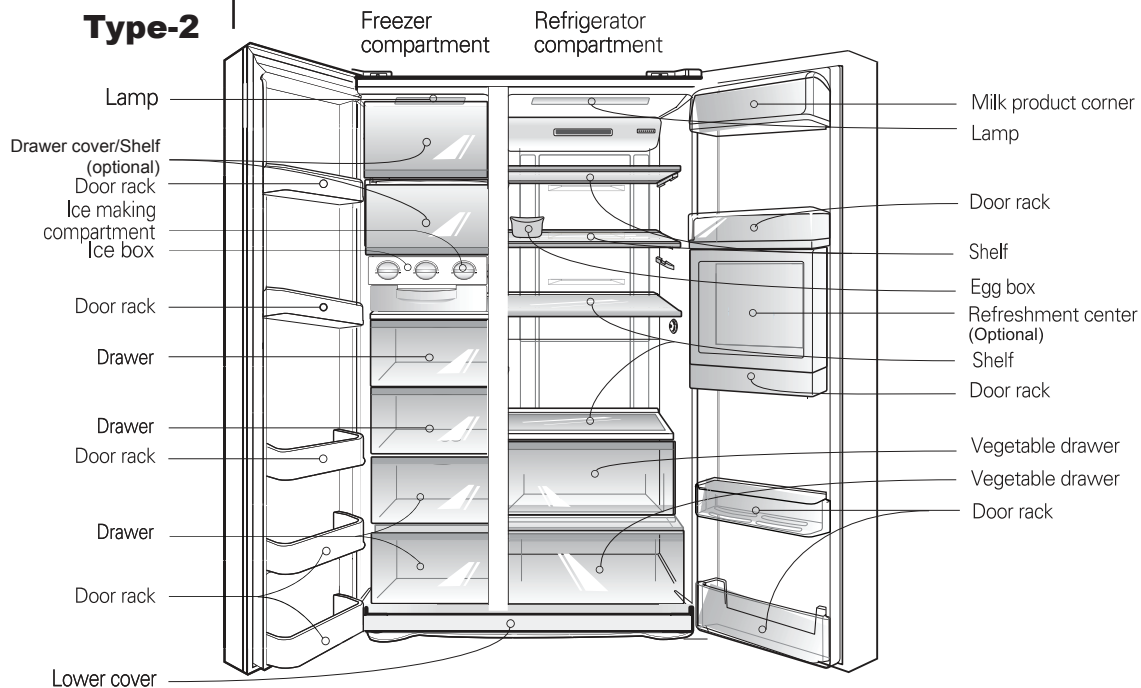

### NOTE

- Parts, features, and options vary by model. Your model may not include every option.

## Select a good location

### Where to install

1. Place your appliance where it is easy to use.
2. Avoid placing the unit near heat sources, direct sunlight or moisture.
3. To ensure proper air circulation around the fridge-freezer, please maintain sufficient space on both the sides as well as top and maintain at least 2 inches (5 cm) from the rear wall.
4. To avoid vibrations, the appliance must be leveled.
5. Don't install the appliance below 5°C . It may cause affect the performance.
6. This appliance is intended to be used in household and similar applications such as staff kitchen areas in shops, offices and other working environments; farm houses and by clients in hotels, motels and other residential type environments;bed and breakfast type environments;catering and similar non-retail applications.

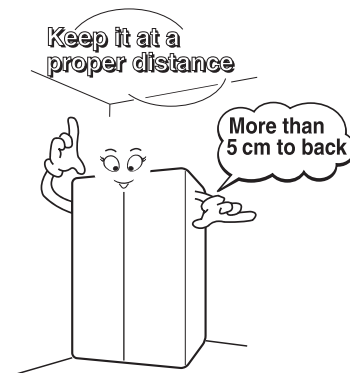

## Disposal of the old appliance

This appliance contains fluid (refrigerant, lubricant)and is made of parts and materials which are reusable and/or recyclable. All the important materials should be sent to the collection center of waste materialand can be reused after rework (recycling). For take back, please contact with thelocal agency.

## **WARNING**

### **Door removal**

#### **Electric Shock Hazard**

Disconnect electrical supply to refrigerator before installing.  
Failure to do so could result in death or serious injury.

**If your access door is too narrow for the refrigerator remove the refrigerator door and pass the refrigerator laterally.**

#### **Remove lower cover**

Remove the lower cover by lifting upward.

#### **Remove the freezer compartment door**

- 1) Loosen the hinge cover screws and remove the cover.
- 2) Remove the keeper by rotating it to counter clockwise ( ① ) and then lifting the upper hinge up ( ② ).

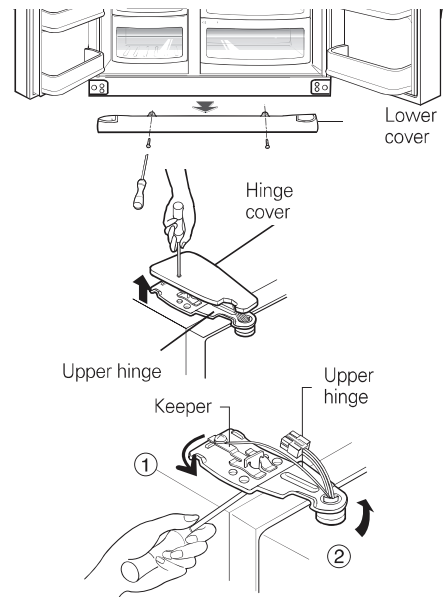

## **CAUTION**

- When removing the upper hinge, be careful that the door does not fall forwards.

- 3) Remove the freezer compartment door by lifting it upward.

#### **Remove the refrigerator door**

- 1) Loosen the hinge cover screws and remove the cover. Remove connection wire, if any, except for the earth line.
- 2) Remove keeper by rotating it clockwise ( ① ) and then remove the upper hinge by lifting it up ( ② ).
- 3) Remove the refrigerator compartment door by lifting it up.

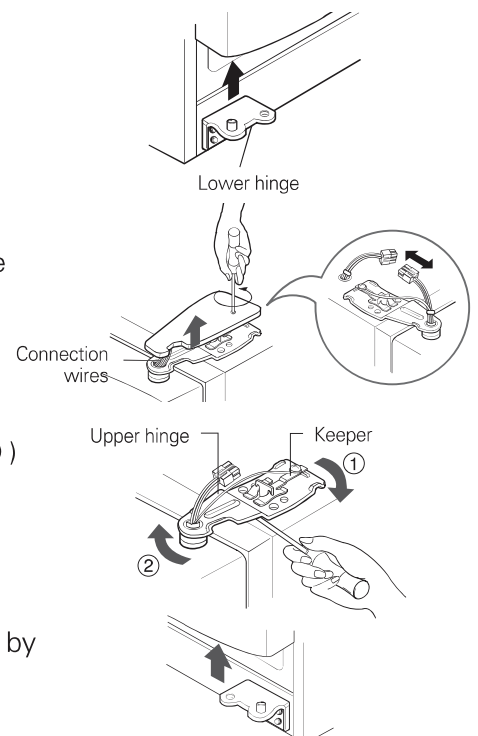

#### **Pass the refrigerator**

Pass the refrigerator laterally through access door as shown in the right figure.

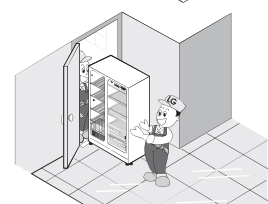

## Door replacement

Mount them in the reverse sequence of removal after they pass through the access door.

## Height adjustment

If the height of freezer compartment door is different from the height of Refrigerator compartment door

If the freezer compartment door is lower than the refrigerator compartment door

Level the door by inserting flat (-type) driver into the groove of the left height adjusting screw and rotate it clockwise (①).

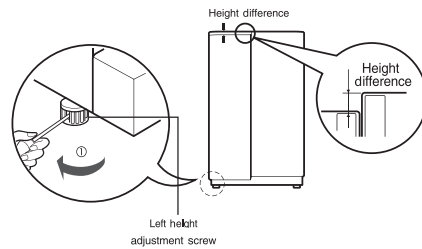

If the freezer compartment door is higher than the refrigerator compartment door

Level the door by inserting flat (-type) driver into the groove of the right height adjusting screw and rotate it clockwise (①).

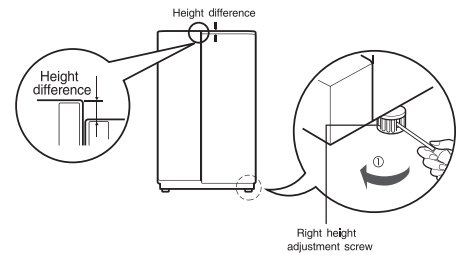

## When the freezer door does not align with the height of the refrigerator door

1. Use the wide side of the adjustment tool ③ to rotate the tightening nut ① in clockwise direction to loosen it.
2. Use the narrow side of the adjustment tool ③ to rotate the adjustment hinge pin ② in either clockwise or counterclockwise direction to level the height of the refrigerator to that of the freezer.
3. After leveling the height of the door, rotate the tightening nut in counterclockwise direction to tighten it all the way.

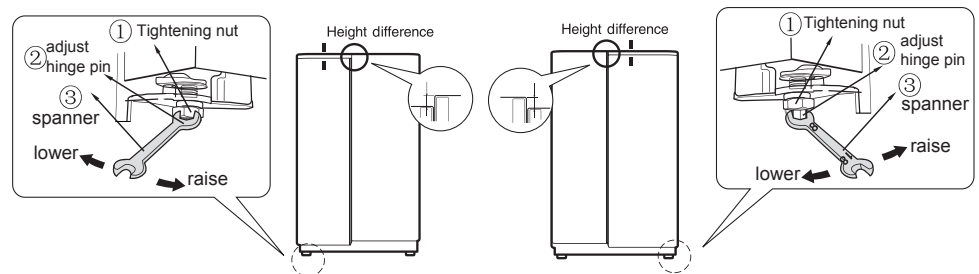

### CAUTION

Do not adjust the height excessively. You can lose the hinge pin. (Height adjustable range: Maximum of 5mm)

After leveling the door height

The refrigerator doors will close smoothly by heightening the front side by adjusting the height adjusting screw. If the doors do not close correctly, performance may be affected.

Next

1. Wipe off all dust accumulated during shipping and clean your appliance thoroughly.
2. Install accessories such as the ice cube box, cover evaporating tray, etc., in their proper places. They are packed together to prevent possible damage during shipping.
3. Connect the power supply cord (or plug) to the outlet. Don't double up with other appliances on the same outlet.

## Starting

When your refrigerator is first installed, allow it to stabilize at normal operating temperatures for 2-3 hours prior to filling it with fresh or frozen foods. If operation is interrupted, wait 5 minutes before restarting.

## Adjusting the temperatures and functions

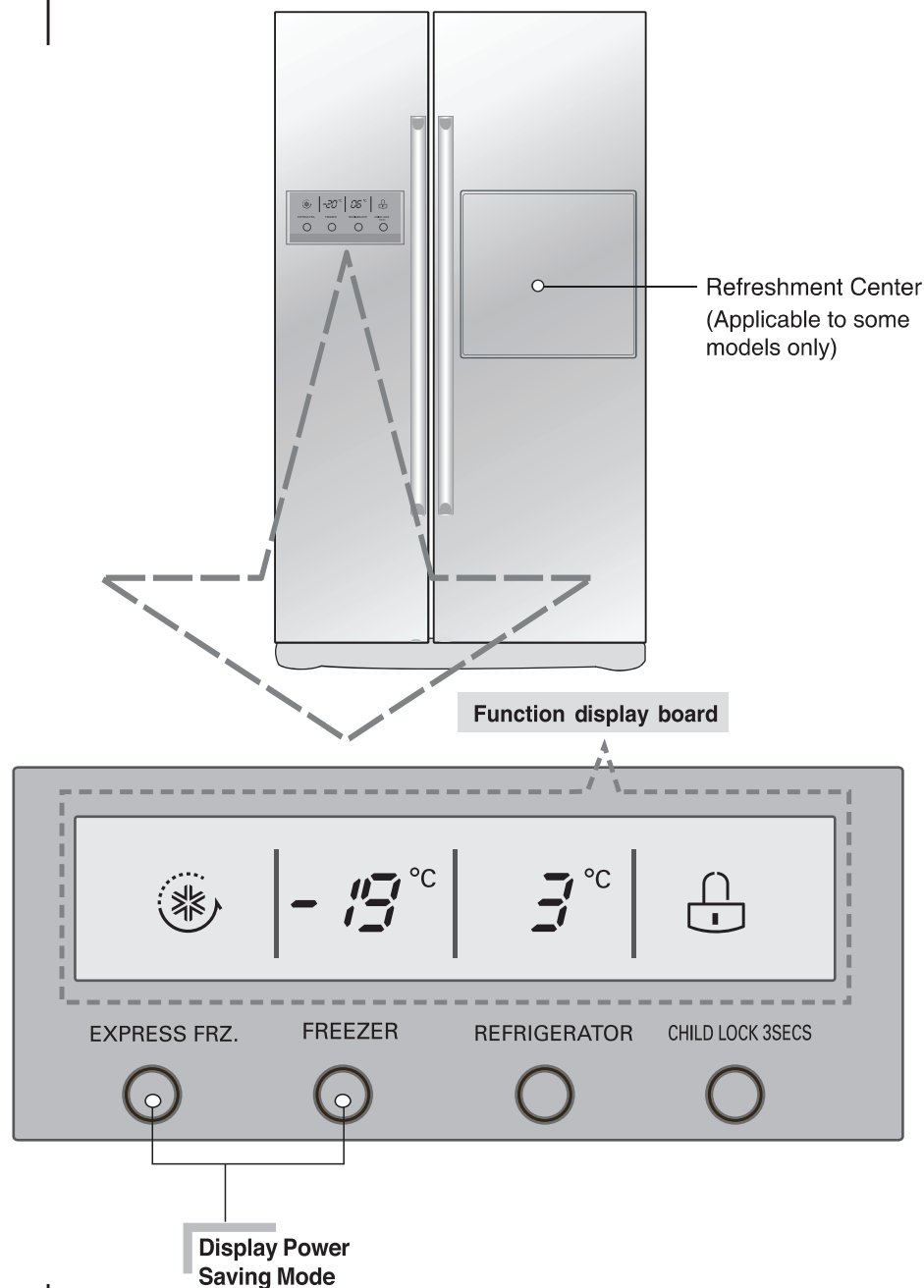

### NOTE

- Your model may not include every option.

### Display Power Saving Mode

This function places the display into power saving mode until the next time the door is opened.

Press the FREEZER and EXPRESS FRZ. buttons simultaneously and hold them for 5 seconds until the Ding sounds. All LED light will then turn ON, then OFF. When the power saving mode is activated, the display will remain off until the next time the door is opened. Then, it will come on whenever a door is opened or a button is pressed and remain on for 20 seconds after the last door opening or button selection. To deactivate the power saving mode, press the FREEZER and EXPRESS FRZ. buttons simultaneously and hold them for 5 seconds until the Ding sounds.

When doors are closed or stopping button selection for 20 seconds, the brightness of LED display will turn down, The power saving mode is activated. When a door is open or a button is pressed, the brightness of LED display will turn up.

**You can adjust temperature of the freezer room and refrigerator room.**

**How to adjust the temperature in the freezer compartment**

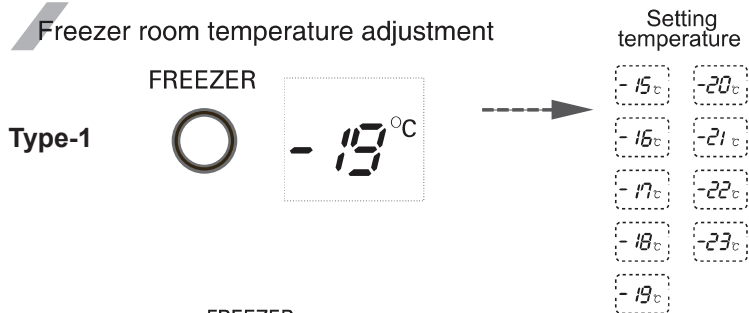

※ Whenever pressing **FREEZER** button, setting is repeated in the order of (-19°C → -20°C → ... → -23°C → -15°C → ... → -19°C).

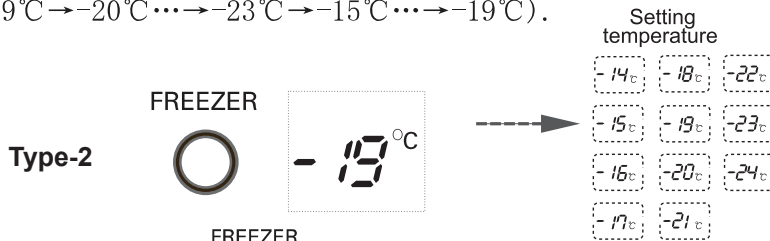

※ Whenever pressing **FREEZER** button, setting is repeated in the order of (-19°C → -20°C → ... → -24°C → -14°C → ... → -19°C).

**How to adjust the temperature in the refrigerator compartment**

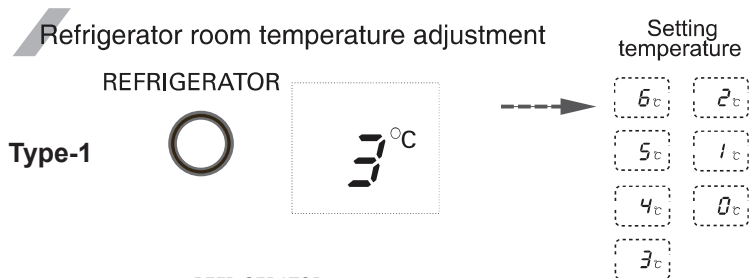

※ Whenever pressing **REFRIGERATOR** button, setting is repeated in the order of (3°C → 2°C → ... → 0°C → 6°C → ... → 3°C).

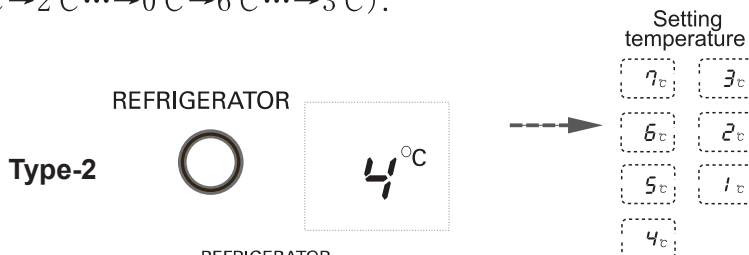

※ Whenever pressing **REFRIGERATOR** button, setting is repeated in the order of (3°C → 2°C → ... → 1°C → 7°C → ... → 3°C).

- The actual inner temperature varies depending on the food status, as the indicated seeing temperature is a target temperature, not actual temperature within refrigerator.
- Refrigeration function is weak in the initial time, Please adjust temperature as above after using refrigerator for minimum 2-3 days.

**Super freezer**

**Please select this function for prompt freezer.**

- “on”and “off ” is repeated whenever pressing EXPRESS FRZ. button.
- The arrow mark graphic remains at the “on” status when selecting Special Refrigeration “on”.
- Super freezer function auto matically turns off if a fixed time passes.

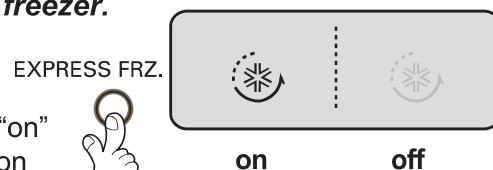

**Lock**

**This button stops operation of different button.**

- Locking or Release is reperated whenever the button is pressed more than 3 seconds.
- When you use the CHILD LOCK 3SECS button, you can not use any other button, until you unlock the unit. When you press the other button when the unit is locked, the  will flash 3 times to notify the current Lock condition.

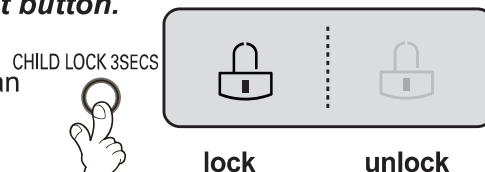

**Door open alarm**

An alarm will sound 3times when the refrigerator door is left open for more than 1 minute. This alarm will be rung at an intervals of 30 sec. and stop at the close of the door. If the alarm sound does not stop even after the freezer and refrigerator compartment doors are closed, contact the service center.

**Self-diagnosis (fault detection) function**

Self-diagnosis function operates when a problem occurs in the unit. When an error occurs in the unit. Immediately contact the service center without turning the power OFF. If the power is OFF, it will take the engineer longer to find out where the fault occurs. The pressing of any function buttons will not alter the temperature setting when a fault occurs.

**How to use the Home Bar**

**Refreshment center (Applicable to some models only)**

1. Press the top central part of the Home Bar until you hear the "Click" sound.
  - You can save electricity because you do not have to open the refrigerator door.
  - Because the indoor lamps of the fridge and freezer are turned on even when you open only the Home Bar door, you can easily take out the food you want.
  - When closing the Home Bar, press until you hear the "Click" sound.
2. Open the door and use the door as the support board.
  - Put the beverage or food on the support board for convenience of use.

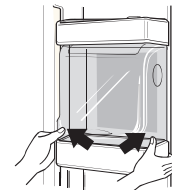
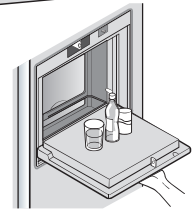
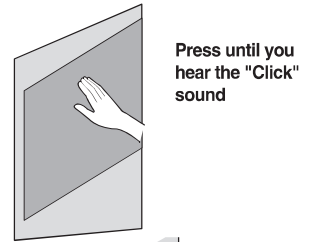

**How to disassemble the fridge Home Bar cover**

First separate the upper door basket of the Home Bar (①) and then pull up the Home Bar cover(②).

**Precaution**

1. Do not use the refrigerator with the internal Home Bar cover taken out.
  - If the cover is taken out, the Home Bar function cannot work.
2. Be careful not to press or damage the Home Bar support board.
  - If you lean or press the support board with your arm, it can be damaged.
  - Do not use the support board as a cutting board or use sharp tools on the support board to prevent any scratches.
  - When the support board is wet with alien fluid such as juice, it may not operate properly.
  - When the packing part is wet with alien fluid such as juice, periodically wipe the part.
  - Never place heavy items on the refreshment center door or allow children to hang it on. Not only can the refreshment center door may be damaged, but also children may be hurt.





When making Ice

**Ice Making**

- Fill water in ice making box of the ice making corner.  
If water is fully filled the ice will not be separated well and water can be dropped to make ice lumped.
- Ice will be dropped into the ice storage bin by rotating ice separation handle of ice making compartment.

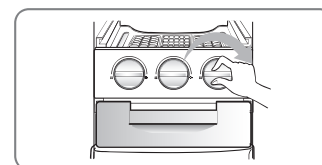
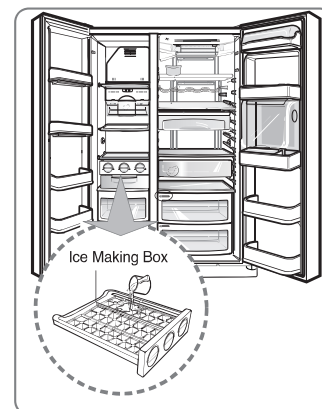

**NOTE**

- Rotating the ice separation handle before ice is fully frozen may cause the remaining water drop into the ice storage bin to lump the ice together.

**Egg box (Applicable to some models only)**

You can move the egg box to wherever you want.

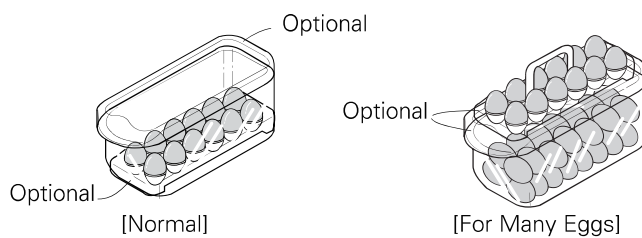

**CAUTION**

- Never use the egg box as an ice storage bin. It can be broken.
- Never store the egg box in the freezer compartment or fresh compartment.

## Shelf

### How to use

You can store side dish or refrigerated food on the shelf with sufficient space in between the containers.



### How to disassemble

1. Lift up the back side of the shelf (①).
2. Pull out the shelf (②).

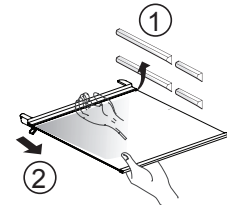

## Deodorizer (Applicable to some models only)

This system efficiently absorbs strong odors by using the optical catalyst. This system does **not** have any affect on stored food.

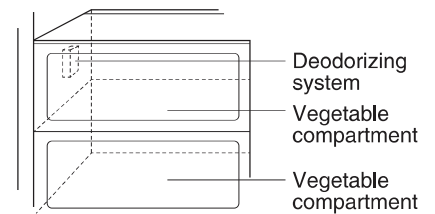

### How to use the deodorizing system

- Since it is installed already installed onto the cool air intake duct from the refrigerator compartment, you need no separate installation.
- Please use closed containers to store food with pungent odors. Otherwise, this odor can be absorbed by other food in the compartment.

### Freezer Compartment

If a large quantity of food is to be placed in the freezer compartment.

- The drawer of freezer compartment shall be taken out of the appliance and the food can be stacked directly on the shelf & bottom of freezer compartment .
- Freezer compartment provides shelf on default to maximize food storage capacity. And also the drawer is provided to convenient usage for watery meat or half-liquid state food.

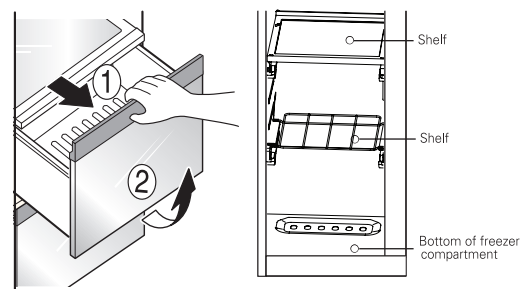

## Location of foods

(Refer to identification of parts)

### Freezer compartment shelf

Store various frozen foods such as meat, fish, ice cream, frozen snacks, etc..

### Freezer compartment door rack

- Store small packed frozen food.
- Temperature is likely to increase as door opens. So, do not store long-term food such ice cream, etc..

### Freezer compartment drawer

- Store meat, fish, chicken, etc.. after wrapping them with thin foil.
- Store dry.

### Milk product corner

Store milk products such as butter, cheese, etc..

### Egg box

Place this egg box in the proper location.

### Refreshment center

Store foods of frequent use such as beverage, etc..

### Refrigerator compartment shelf

Store side dishes or other foods at a proper distance.

### Refrigerator compartment door rack

Store small packed food or beverages such as milk, juice, beer, etc..

### Vegetable drawer

Store vegetable, fruits, meat to thaw, raw fish, etc..

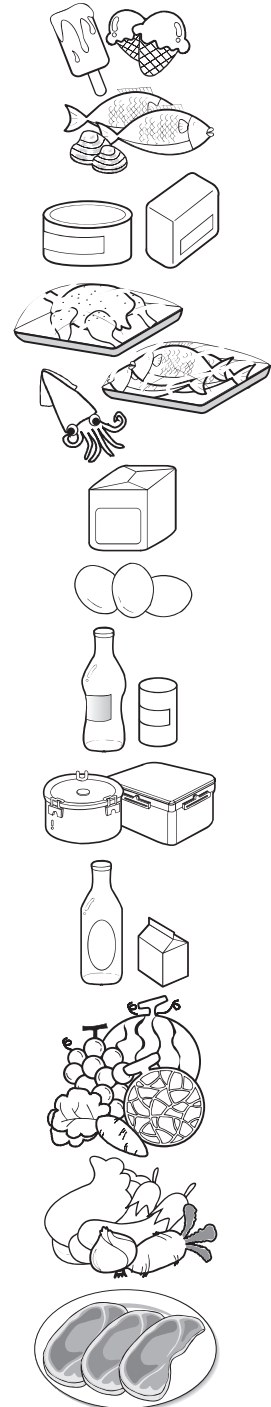

## Storing foods

- Store fresh food in the refrigerator compartment. How food is frozen and thawed is an important factor in maintaining its freshness and flavor.
- Do not store food which goes bad easily at low temperatures, such as bananas, and melons.
- Allow hot food to cool prior to storing, placing hot food in the refrigerator could spoil other food, and lead to higher energy consumption.
- When storing the food, cover it with vinyl wrap or store in a container with a lid. This prevents moisture from evaporating, and helps food to keep its taste and nutrients.
- Do not block air vents with food. Smooth circulation of chilled air keeps refrigerator temperatures even.
- Do not open the door frequently. Opening the door lets warm air enter the refrigerator, and cause temperatures to rise.
- Never keep too much food in door rack because they may push against by inner racks so that the door cannot be fully closed.

### Freezer compartment

- Do not store bottles in the freezer compartment - they may break when frozen.
- Do not refreeze food that has been thawed. This causes loss of taste and nutrient.
- When storing frozen food like ice cream for a long period, place it on the freezer shelf, not in the door rack.
- Do not touch the cold foods or containers- especially made of metallic -, with wet hands and place glass products in the freezer compartment.



### CAUTION

- That's why you may have chilblains and they may be broken when their inner matters are frozen, causing personal injury.

### Refrigerator compartment

- Avoid placing moist food in top refrigerator shelves, it could freeze from direct contact with chilled air.
- Always clean food prior to refrigeration. Vegetables and fruits should be washed and wiped, and packed food should be wiped, to prevent adjacent food from spoiling.
- When storing eggs in their storage rack or box, ensure that they are fresh, and always store them in an upright position, which keeps them fresh longer.

### NOTE

- If you keep the refrigerator in a hot and humid place, frequent opening of the door or storing a lot of vegetables in it may cause dew to form which has no effect on its performance. Remove the dew with dust cloth free from care.

## How to dismantle parts

### NOTE

- Dismantling is done in the reverse sequence of assembly.  
Be sure to unplug the power plug before dismantling and assembly.  
Never apply severe force to dismantle parts. Parts may be damaged.

### Freezer compartment shelf

To remove a shelf, push the shelf to the left ②, lift the left part of the shelf a bit ①, lift the right part up ③, and take it out.

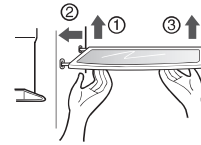

### Door rack and support

Lift the door rack to ① direction holding both sides and pull it out to ② direction.

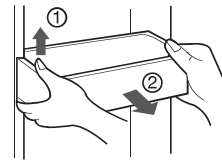

### Refreshment center (In select model only)

- Separate the door rack (①) to upward.
- Separate cover of the refreshment center (②) to upward.
- The door rack (③) can be removed by pulling it upwards.

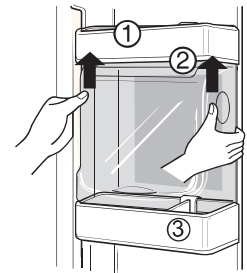

### NOTE

- Be sure to remove parts from the refrigerator door when removing the vegetable compartment and snack corner.

### Vegetable compartment cover

- To remove the vegetable compartment cover, pull out the vegetable compartment to the front ①, lift the **back** part of the vegetable compartment cover as shown by ②, and take it out.

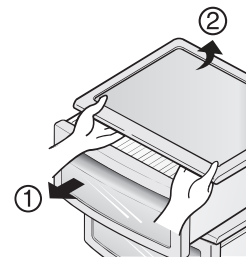

## General information

### Vacation time

During average length vacations, you will probably find it best to leave the refrigerator in operation. Place freezable items in freezer for longer life.

When you plan not to operate, remove all food, disconnect the power cord, clean the interior thoroughly, and leave each door OPEN to prevent odor formation.

### Power failure

Most power failures that are corrected in an hour or two will not affect your refrigerator temperatures.

However, you should minimize the number of door openings while the power is off.

### If you move

Remove or securely fasten down all loose items inside the refrigerator.

To avoid damaging the height adjusting screws, turn them all the way into the base.

### Anti condensation pipe

The outside wall of the refrigerator cabinet may sometimes get warm, especially just after installation.

Don't be alarmed. This is due to the anti-condensation pipe, which pumps hot refrigerator to prevent "sweating" on the outer cabinet wall.

## Cleaning

It is important that your refrigerator be kept clean to prevent undesirable odors. Spilled food should be wiped up immediately, since it may acidify and stain plastic surfaces if allowed to settle.

### Exterior

Use a lukewarm solution of mild soap or detergent to clean the durable finish of your refrigerator. Wipe with a clean damp cloth and then dry.

**For products with a stainless steel exterior, use a clean sponge or soft cloth and a mild detergent in warm water. Do not use abrasive or harsh cleaners. Dry thoroughly with a Soft cloth. Do not use appliance wax, bleach, or other products containing chlorine on stainless steel.**

### Interior

Regular cleaning is recommended. Wash all compartments a baking soda solution or a mild detergent and warm water. Rinse and dry.

### After cleaning

Please verify that the power cord is not damaged, power plug is not overheated, or power plug is well inserted into the power consent.

## WARNING

Always remove power cord from the wall outlet prior to cleaning in the vicinity of electrical parts (lamps, switches, controls, etc.).

Wipe up excess moisture with a sponge or cloth to prevent water or liquid from getting into any electrical part and causing an electric shock.

Never use metallic scouring pads, brushes, coarse abrasive cleaners, strong alkaline solutions, flammable or toxic cleaning liquids on any surface.

Do not touch frozen surfaces with wet or damp hands, because damp object will stick or adhere to extremely cold surfaces.

## Trouble shooting

Before calling for service, review this list. It may save you both time and expense. This list includes common occurrences that are not the result of defective workmanship or materials in this appliance.

| Occurrence                                    | Possible cause  | Solution   |
|---|---|--|
| <b>Runing of refrigerator</b>                 |   |  |
| <b>Refrigerator compressor does not run.</b>  | Refrigerator control is off.  | Set refrigerator control. See setting the controls.  |
|   | Refrigerator is in defrost cycle.   | This is normal for a fully automatic defrosting refrigerator. The defrost cycle occurs periodically.                             |
|   | Plug at wall outlet is disconnected.                                      | Make sure plug is tightly pushed into outlet.  |
|   | Power outage. Check house lights.   | Call local electric company.   |
| <b>Refrigerator runs too much or too long</b> | Refrigerator is larger than the previous one you owned.                   | This is normal. Larger, more efficient units run longer in these conditions.   |
|   | Room or outside weather is hot.   | It is normal for the refrigerator to work longer under these conditions.   |
|   | Refrigerator has recently been disconnected for a period of time.         | It takes some hours for the refrigerator to cool down completely.  |
|   | Large amounts of warm or hot food may have been stored recently.          | Warm food will cause the refrigerator to run longer until the desired temperature is reached.                                    |
|   | Doors are opened too frequently or too long.                              | Warm air entering the refrigerator causes it to run longer. Open the door less often.  |
|   | Refrigerator or freezer door may be slightly open.                        | Make sure the refrigerator is level. Keep food and containers from blocking door. See problem section. OPENING/CLOSING of doors. |
|   | Refrigerator control is set too cold.                                     | Set the refrigerator control to a warmer setting until the refrigerator temperature is satisfactory.                             |
|   | Refrigerator or freezer gasket is dirty, worn, cracked, or poorly fitted. | Clean or change gasket. Leaks in the door seal will cause refrigerator to run longer in order to maintain desired temperatures.  |
|   | Thermostat is keeping the refrigerator at a constant temperature.         | This is normal. Refrigerator goes on and off to keep the temperature constant.   |

| Occurrence  | Possible cause  | Solution   |
|---|---|--|
| <b>Temperatures are too cold</b>  |   |  |
| <b>Temperature in the freezer is too cold and the refrigerator temperature is satisfactory.</b> | Freezer control is set too cold   | Set the freezer control to a warmer setting until the freezer temperature is satisfactory.       |
| <b>Temperature in the refrigerator is too cold and the freezer temperature is satisfactory.</b> | Refrigerator control is set too cold.   | Set the refrigerator control to a warmer setting   |
| <b>Food stored in drawers freezes.</b>  | Refrigerator control is set too cold.   | See above solution.  |
| <b>Meat stored in fresh meat drawer freezes.</b>  | Meat should be stored at temperature just below the freezing point of water (32 ° F, 0 ° C) for maximum fresh storage time. | It is normal for ice crystals to form due to the moisture content of meat.                       |
| <b>Temperatures are too warm</b>  |   |  |
| <b>Temperatures in the freezer is too warm.</b>   | Freezer control is set too warm.  | Set the freezer control to a colder setting until the freezer temperature is satisfactory.       |
|   | Refrigerator control is set too warm. Refrigerator control has some effect on freezer temperature.                          | Set the freezer control to a colder setting until the freezer temperature is satisfactory.       |
| <b>Temperatures in the refrigerator or freezer is too warm.</b>                                 | Doors are opened too frequently or too long.  | Warm air enters the refrigerator/ freezer whenever the door is opened. Open the door less often. |
|   | Door is open slightly.  | Close the door completely.   |
|   | Large amounts of warm or hot food may have been stored recently.  | Wait until the refrigerator or freezer has had a chance to reach its selected temperature.       |
|   | Refrigerator has recently been disconnected for a period of time.   | A refrigerator requires some hours to cool down completely.                                      |
| <b>Temperature in the refrigerator is too warm and the freezer temperature is satisfactory.</b> | Refrigerator control is set too warm.   | Set the refrigerator control to a colder setting.  |



| Occurrence   | Possible cause  | Solution   |
|--|---|--|
| <b>Sound and noise</b>   |   |  |
| <b>Louder sound levels when refrigerator is on.</b>                | Today's refrigerators have increased storage capacity and maintain more even temperatures.                  | It is normal for sound levels to be higher.  |
| <b>Louder sound levels when compressor comes on.</b>               | Refrigerator operates at higher pressures during the start of the ON cycle.                                 | This is normal. Sound will level off as refrigerator continues to run.   |
| <b>Vibrating or rattling noise.</b>                                | Floor is uneven or weak. Refrigerator rocks on the floor when it is moved slightly.                         | Be sure floor is level and solid and can adequately support refrigerator.  |
|  | Items placed on the top of refrigerator are vibrating.  | Remove items.  |
|  | Dishes are vibrating on the shelves in the refrigerator.  | It is normal for dishes to vibrate slightly. Move dishes slightly. Make sure refrigerator is level and solidly set on floor. |
|  | Refrigerator is touching wall or cabinets.  | Relieve or move refrigerator   |
| <b>Water/Moisture /Ice inside refrigerator</b>                     |   |  |
| <b>Moisture collects on inside of refrigerator walls.</b>          | Weather is hot and humid which increases rate of frost buildup and internal sweating.                       | This is normal.  |
|  | Door is slightly open.  | See problem section opening/closing of doors.  |
|  | Door is opened too often or too long.   | Open the door less often.  |
| <b>Water/Moisture /Ice outside refrigerator</b>                    |   |  |
| <b>Moisture forms on outside of refrigerator or between doors.</b> | Weather is humid.   | This is normal in humid weather. When humidity is lower, the moisture should disappear.                                      |
|  | Door is slightly open, causing cold air from the inside the refrigerator to meet warm air from the outside. | This time, close the door completely.  |

| Occurrence                                 | Possible cause  | Solution   |
|--|---|--|
| <b>Odors in refrigerator</b>               |   |  |
|  | Interior needs to be cleaned.   | Clean interior with sponge, warm water and baking soda.  |
|  | Food with strong odor is in refrigerator.   | Cover food completely.   |
|  | Some containers and wrapping paper produce odors.                                   | Use a different container or brand of wrapping paper.  |
| <b>Opening/Closing of doors/Drawers</b>    |   |  |
| <b>Door(s) will not close.</b>             | Food package is keeping door open.  | Move packages that keep door from closing.   |
| <b>Door(s) will not close. (Continued)</b> | Door was closed too hard, causing other door to open slightly.                      | Close both doors gently.   |
|  | Refrigerator is not level. It rocks on the floor when it is moved slightly.         | Adjust the height adjusting screw.   |
|  | Floor is uneven or weak. Refrigerator rocks on the floor when it is moved slightly. | Be sure floor is level and can adequately support refrigerator. Contact carpenter to correct sagging or sloping floor. |
|  | Refrigerator is touching wall or cabinets.  | Relieve or move refrigerator..   |
| <b>Drawers are difficult to move.</b>      | Food is touching shelf on top of drawer   | Keep less food in drawer.  |
|  | Track that drawer slides on is dirty.   | Clean drawer and track.  |
| <b>Other</b>                               | Please thoroughly read this manual.   |  |

## It is Normal...

The following occurrences are normal.

|                             | Occurrence   | Solution   |
|-----------------------------|--|--|
| <b>Noise</b>                | When you hear "Tak" or "Took" sound  | This is the sound of various parts expanding/contracting or various control devices operating depending on the temperature change within the refrigerator.   |
|                             | When you hear "Deureureuk~", "Dulkuk" or "Woong" sound                                   | This is the count of compressor or fan operating when the operation of the refrigerator is starting or ending. This is the same phenomenon of the sound generated when starting or turning off the engine of a car.  |
|                             | When you hear "Kureureuk" sound of water flowing   | This is the sound of refrigerant changing the condition in the freezer/fridge. When the liquid changes to gas, you will hear the sound of water flowing and when gas changes to liquid, you will hear the "Kureureuk" sound.   |
|                             | When you hear the sound of wind such as "Shoo~" or "Shik" right after you close the door | This is the sound generated when the internal pressure is temporarily lowered when the warm air entered through the fridge or freezer is cooled fast.  |
|                             | When you hear the vibrating sound  | If the refrigerator is installed on wooden floor or wooden wall, or if the refrigerator is not leveled properly, the sound can be loud from the vibration.   |
|                             | When you hear a loud sound after installing the product for the first time               | When you operate the refrigerator for the first time, the refrigerator will operate at high speed to cool fast and the sound can seem louder. When the internal temperature falls below a certain level, the noise will subside.   |
| <b>Door open</b>            | When the door is slightly opened after closing the door                                  | Depending on the force or speed of closing the fridge or freezer door, the door can open slightly and then get closed.<br>Be careful not to close the door too hard.   |
| <b>Icing/<br/>Dew drops</b> | When there is icing or dew drops formed on the inner or outer side of the refrigerator   | When external air flows into the cool inner surface of the refrigerator, icing/dew drops can be formed. Especially, this will happen more easily when you open and close the refrigerator door more frequently. Also if the humidity of the installed location is high or during the rainy season or on a rainy day, dew drops can form on the outer side of the refrigerator. This is a natural phenomenon that occurs during the humid weather. Wipe the water drops with a dry cloth. |
| <b>Temperature</b>          | When the front side of the refrigerator is warm  | Heat pipes are installed around the front part of the refrigerator and on the divider of the freezer and fridge to prevent the dew drops from forming. The refrigerator may feel warmer after the installation or during the hot summer, but this is not a problem and you can be rest assured.  |

## Smart Diagnosis (Applicable to some models only)

Should you experience any problems with your refrigerator, it has the capability of transmitting data via your telephone to the LG service center. This gives you the capability of speaking directly to our trained specialists. The specialist records the data transmitted from your machine and uses it to analyze the issue, providing a fast and effective diagnosis.

If you experience problems with your refrigerator, call to the LG service center. Only use the Smart Diagnosis feature when instructed to do so by the LG call center agent. The transmission sounds that you will hear are normal and sound similar to a fax machine.

Smart Diagnosis cannot be activated unless your refrigerator is connected to power. If your refrigerator is unable to turn on, then troubleshooting must be done without using Smart Diagnosis.

### Using Smart Diagnosis

First, call to the LG service center. Only use the Smart Diagnosis feature when instructed to do so by the LG call center agent.

1. Lock the display. To lock the display, press and hold the Lock button for three seconds. (If the display has been locked for over five minutes, you must deactivate the lock and then reactivate it.)



2. Open the right refrigerator door.

3. Hold the mouthpiece of your phone in front of the speaker that is located on the right hinge of the refrigerator door, when instructed to do so by the call center.

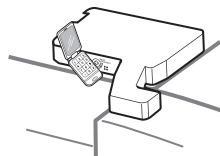

4. Press and hold the Freezer Temperature button for three seconds while continuing to hold your phone to the speaker.



5. After you hear three beeps, release the Freezer Temperature button.
6. Keep the phone in place until the tone transmission has finished. This takes about 3 seconds, and the display will count down the time. Once the countdown is over and the tones have stopped, resume your conversation with the specialist, who will then be able to assist you in using the information transmitted for analysis.

#### NOTE

- For best results, do not move the phone while the tones are being transmitted.
- If the call center agent is not able to get an accurate recording of the data, you may be asked to try again.
- Call quality differences by region may affect the function.
- Use the home telephone for better communication performance, resulting in better service.
- Bad call quality may result in poor data transmission from your phone to the machine, which could cause Smart Diagnosis to not work properly.