



OWNER'S MANUAL

# 2.1 Channel Powerful Bass Sound Bar

Please read this manual carefully before operating your set and retain it for future reference.

NB2540 (NB2540, S24A1-W)

# Safety Information



**CAUTION**  
RISK OF ELECTRIC SHOCK  
DO NOT OPEN



**CAUTION:** TO REDUCE THE RISK OF ELECTRIC SHOCK DO NOT REMOVE COVER (OR BACK) NO USER-SERVICEABLE PARTS INSIDE REFER SERVICING TO QUALIFIED SERVICE PERSONNEL.

This lightning flash with arrowhead symbol within an equilateral triangle is intended to alert the user to the presence of uninsulated dangerous voltage within the product's enclosure that may be of sufficient magnitude to constitute a risk of electric shock to persons.



The exclamation point within an equilateral triangle is intended to alert the user to the presence of important operating and maintenance (servicing) instructions in the literature accompanying the product.



**WARNING:** TO PREVENT FIRE OR ELECTRIC SHOCK HAZARD, DO NOT EXPOSE THIS PRODUCT TO RAIN OR MOISTURE.

**CAUTION:** The apparatus shall not be exposed to water (dripping or splashing) and no objects filled with liquids, such as vases, shall be placed on the apparatus.

**WARNING:** Do not install this equipment in a confined space such as a book case or similar unit.

**CAUTION:** Do not block any ventilation openings. Install in accordance with the manufacturer's instructions.

Slots and openings in the cabinet are provided for ventilation and to ensure reliable operation of the product and to protect it from over heating. The openings shall be never be blocked by placing the product on a bed, sofa, rug or other similar surface. This product shall not be placed in a built-in installation such as a bookcase or rack unless proper ventilation is provided or the manufacturer's instruction has been adhered to.

## CAUTION concerning the Power Cord

Most appliances recommend they be placed upon a dedicated circuit;

That is, a single outlet circuit which powers only that appliance and has no additional outlets or branch circuits. Check the specification page of this owner's manual to be certain. Do not overload wall outlets. Overloaded wall outlets, loose or damaged wall outlets, extension cords, frayed power cords, or damaged or cracked wire insulation are dangerous. Any of these conditions could result in electric shock or fire. Periodically examine the cord of your appliance, and if its appearance indicates damage or deterioration, unplug it, discontinue use of the appliance, and have the cord replaced with an exact replacement part by an authorized service center. Protect the power cord from physical or mechanical abuse, such as being twisted, kinked, pinched, closed in a door, or walked upon. Pay particular attention to plugs, wall outlets, and the point where the cord exits the appliance. To disconnect power from the mains, pull out the mains cord plug. When installing the product, ensure that the plug is easily accessible.

**NOTICE:** For Product Identification and Compliance/Safety labeling information please refer to Main Label on the bottom of Unit.

This device is equipped with a portable battery or accumulator.

**Safety way to remove the battery from the equipment:** Remove the old battery or battery pack, follow the steps in reverse order than the assembly. To prevent contamination of the environment and bring on possible threat to human and animal health, the old battery or the battery put it in the appropriate container at designated collection points. Do not dispose of batteries or battery together with other waste. It is recommended that you use local, free reimbursement systems batteries and accumulators. The battery should not be exposed to excessive heat such as sunshine, fire or the like.

### Disposal of your old appliance



1. All electrical and electronic products should be disposed of separately from the municipal waste stream via designated collection facilities appointed by the government or the local authorities.
2. The correct disposal of your old appliance will help prevent potential negative consequences for the environment and human health.
3. For more detailed information about disposal of your old appliance, please contact your city office, waste disposal service or the shop where you purchased the product.

### Disposal of waste batteries/accumulators



1. This symbol may be combined with chemical symbols for mercury(Hg), cadmium(Cd) or lead(Pb) if the battery Contains more that 0.0005% of mercury,0.002% of cadmium or 0.004% of lead.
2. All batteries/accumulators should be disposed separately from the municipal waste stream via designated collection facilities appointed by the government or the local authorities.
3. The correct disposal of Your old batteries/accumulators will help to prevent potential negative consequences for the environment, animal and human health.
4. For more detailed information about disposal of Your old batteries/accumulators, please contact Your city office, waste disposal service or the shop where You purchased the product.

## Europe Notice

# CE 0197

LG Electronics hereby declares that this/these product(s) is/are in compliance with the essential requirements and other relevant provisions of Directive 1999/5/EC, 2004/108/EC, 2006/95/EC, 2009/125/EC and 2011/65/EU.

Please contact to the following address for obtaining a copy of the DoC (Declaration of Conformity).

### **Contact office for compliance of this product:**

LG Electronics Inc.  
EU Representative, Krijgsman 1,  
1186 DM Amstelveen, The Netherlands

- Please note that this is NOT a Customer Service contact point. For Customer Service Information, see Warranty Card or contact the dealer that you purchased this product.

Indoor Use Only

### **RF Radiation Exposure Statement**

This equipment should be installed and operated with minimum distance 20 cm between the radiator and your body.

# Table of Contents

## 1 Getting Started

---

- 2 Safety Information
- 6 Unique features
- 6 Introduction
  - 6 – Symbols used in this manual
- 7 Remote control
- 8 Front panel
- 8 Rear panel
- 9 About LED condition
- 10 Installing the sound bar
- 11 Mounting the main unit on a wall

## 2 Connecting

---

- 13 Connecting the subwoofer
  - 13 – Attaching the subwoofer to the unit
- 13 Connecting to your TV
  - 13 – Using an OPTICAL cable
- 14 Optional equipment connection
  - 14 – PORT. (Portable) IN connection
  - 14 – OPT.(OPTICAL) IN connection

## 3 Operating

---

- 15 Operations
  - 15 – DRC (Dynamic Range Control)
  - 15 – Turn off the sound temporarily
  - 15 – AUTO POWER On/Off
  - 16 – Auto power down
  - 16 – LG Sound Sync
- 17 Using Bluetooth technology
  - 18 – Listening to music stored on the Bluetooth devices
- 19 Sound adjustment
  - 19 – Setting sound effect
  - 19 – Adjust volume level automatically
  - 19 – Adjust the woofer level settings
- 20 Controlling a TV with the supplied remote control

## 4 Troubleshooting

---

- 21 Troubleshooting

## 5 Appendix

---

- 22 Specifications
- 23 Trademarks and licenses
- 23 Maintenance
  - 23 – Handling the unit

1

2

3

4

5

## Unique features

### Auto power down

This unit will power off by itself for energy saving consumption.

### Portable In

Listen to music from your portable device. (MP3, Notebook, etc)

### Speaker (easy) setup

Listen to sound from TV, DVD or Digital device with vivid 2.1 ch mode.

### LG Sound Sync

Controls volume level of this unit by the remote control of your LG TV that is compatible with LG Sound Sync.

## Introduction

### Symbols used in this manual

 **Note**

Indicates special notes and operating features.

 **Caution**

Indicates cautions for preventing possible damages from abuse.

## Remote control

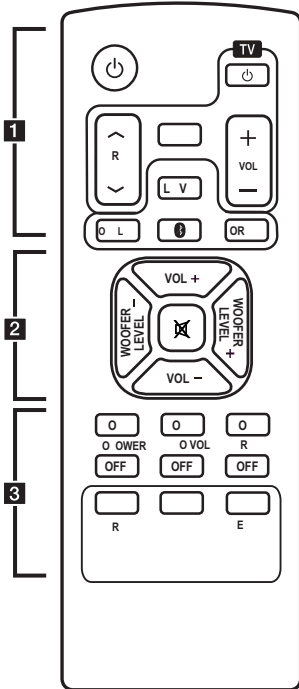

..... **1** .....

**⏻** (Power) : Switches the unit ON or OFF.

**TV Control buttons** : See page 20.

**LG TV** : Select LG TV function.

**OPTICAL** : Select Optical function.

**📶** : Select Bluetooth function.

**PORT.IN** : Select Portable In function.

..... **2** .....

**🔇** : Mutes the sound.

**WOOFER LEVEL +/-** : Sets the sound level of woofer.

**VOL +/-** : Adjusts speaker volume.

..... **3** .....

**AUTO POWER ON/OFF** : This function automatically powers on or off the unit.

**AUTO VOL ON/OFF** : Turns on or off the AUTO VOLUME mode.

**DRC ON/OFF** : Turns on or off DRC function.

**STANDARD** : Selects **STANDARD** sound effect.

**MUSIC** : Selects **MUSIC** sound effect.

**CINEMA** : Selects **CINEMA** sound effect.

## Replacement of battery

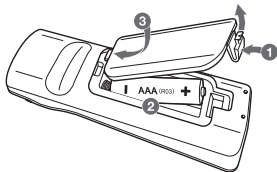

Remove the battery cover on the rear of the Remote Control, and insert two (size AAA) batteries with **+** and **-** matched correctly.

# Front panel

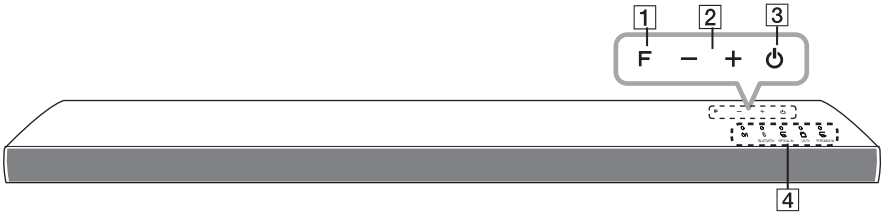

- 1** **F** (Function)  
Selects the function and input source.
- 2** **-/+** (Volume)  
Adjusts volume level.
- 3** **⏻** (Standby/On)
- 4** LED indicator

**! Note**

Precautions in using the touch buttons

- Use the touch buttons with clean and dry hands.  
- In a humid environment, wipe out any moisture on the touch buttons before using.
- Do not apply too much pressure on the touch buttons.  
-If you apply too much pressure, it can damage the sensor of the touch buttons.
- Touch the button that you want to work in order to operate the function correctly.
- Be careful not to have any conductive material such as metallic object on the touch buttons. It can cause malfunctions.



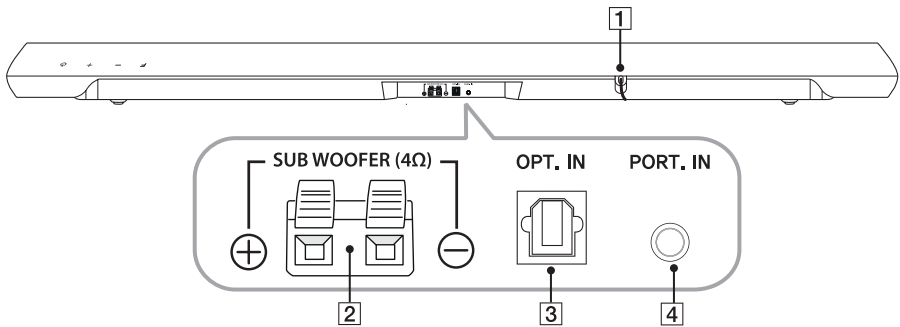





# Rear panel



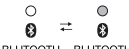

- 1** Power cord
- 2** **SUB WOOFER(4Ω)** Connector
- 3** **OPT. IN** : Optical input
- 4** **PORT. IN** : Portable input



## About LED condition

Function	Condition	LED	Description
On/Off	Turn on the unit.		Turned off.
	Turn off the unit.		Turned on.
Bluetooth	Bluetooth Paired.	 BLUETOOTH BLUETOOTH	Turned on for few seconds.
	Bluetooth Ready.	 BLUETOOTH BLUETOOTH	Blinks quickly.
Optical	Selects Optical In.	 OPTICAL IN OPTICAL IN OPTICAL IN	Turned on for few seconds.
Portable	Selects Portable In.	 PORTABLE IN PORTABLE IN PORTABLE IN	Turned on for few seconds.
LG Sound Sync	LG Sound Sync Connected.	 LG TV LG TV	Turned on for few seconds.
	LG Sound Sync Ready.	 LG TV LG TV	Blinks quickly.
Mute	Turn off the sound temporarily.		Blinks slowly.

### ! Note

- Once the unit is shut down to standby, please wait several seconds before trying to use remote again.
- When you press any button,  LED on the main unit blink twice.
- When you change function, please wait several seconds for operating.
- When you press  (mute), LED on the main unit can not indicate other functions.

## Installing the sound bar

You can hear the sound by connecting the unit to the other device : TV, Blu-ray disc player, DVD player, etc.

Place the unit in front of the TV and connect it to the device you want. (Refer to pp. 13 - 14.)

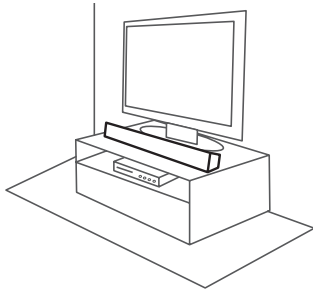

### Caution

For best performance of wireless connection such as Bluetooth, do not install the unit on Metallic furniture because wireless connection communicates through a module positioned on the bottom of the unit.

# Mounting the main unit on a wall

You can mount the main unit on a wall.

## Preparation materials

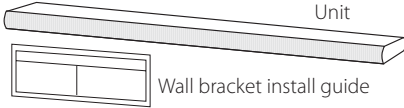

(Not supplied)



1. Match the TV's BOTTOM EDGE of Wall bracket install guide with the bottom of TV and attach to the position.

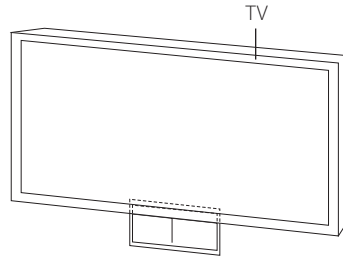

2. When you mount it on a wall (concrete), use the wall plugs. You should drill some holes. A guide sheet (Wall bracket install guide) is supplied to drill. Use the sheet to check the point to drill.

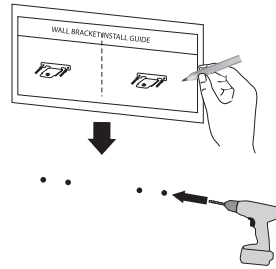

3. Remove the Wall bracket install guide.

4. Fix the brackets with screws (A) as shown in the illustration below.

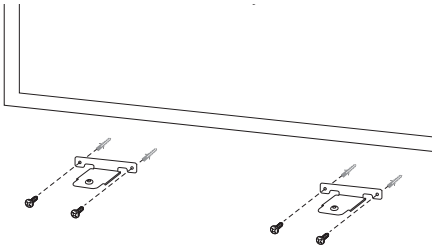

**! Note**

Screws (A) and Wall Plugs are not supplied for mounting the unit. We recommend the Hilti (HUD-1 6 x 30) for the mounting.

5. Put the unit on the brackets to match screw holes on the bottom of the unit.

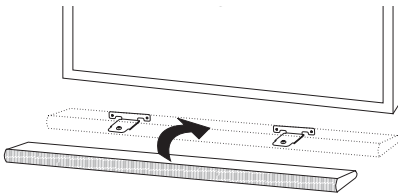

6. Fix the unit with the screws firmly.

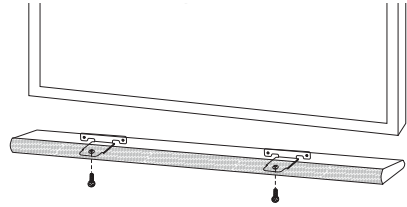

**! Note**

To detach the unit, perform it in reverse order.

**! Caution**

- Do not install this unit upside down. It can damage the parts of this unit or be the cause of personal injury.
- Do not hang onto the installed unit and avoid any impact to the unit.
- Secure the unit firmly to the wall so that it does not fall off. If the unit falls off, it may result in an injury or damage to the product.
- When the unit is installed on a wall, please make sure that a child does not pull any of connecting cables, as it may cause it to fall.

## Connecting the subwoofer

### Attaching the subwoofer to the unit

To connect the cable to the unit, press each plastic finger pad to open the connection terminals on the unit. Insert the wire and release the finger pad.

Connect the black stripe of each wire to the terminals marked - (minus) and the other end to the terminals (red tube) marked + (plus).

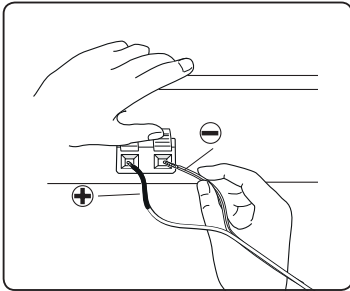

## Connecting to your TV

### Using an OPTICAL cable

1. Connect the OPT. IN jack on the back of the unit to OPTICAL OUT jack on the TV using an OPTICAL cable.

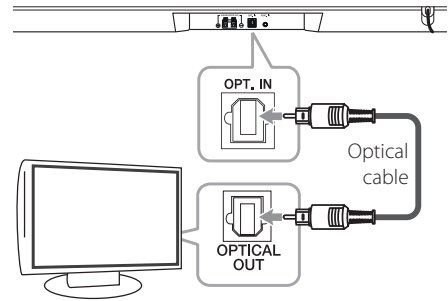

2. Set the INPUT source to OPTICAL. Press **OPTICAL** on the remote control or **F** on the unit until the function is selected.

#### ! Note

You can enjoy the TV audio through the speakers of this unit. In the case of some TV models, you must select the external speaker option from the TV menu. (For details, reference your TV user manual.)

## Optional equipment connection

### PORT. (Portable) IN connection

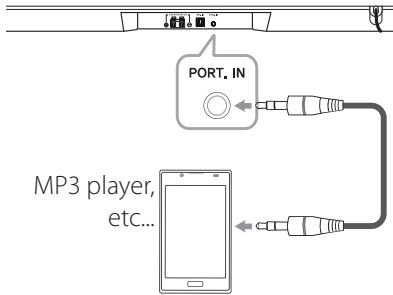

### Listening to music from your portable player

The unit can be used to play the music from many types of portable players or external devices.

1. Connect the portable player to the PORT. (Portable) IN connector of the unit.
2. Turn the power on by pressing  (Power).
3. Select the PORTABLE IN function by pressing **PORT.IN** on the remote control or **F** on the unit until the function is selected.
4. Turn on the portable player or external device and start playing it.

### OPT.(OPTICAL) IN connection

Connect an optical output jack of external devices to the OPT. IN jack.

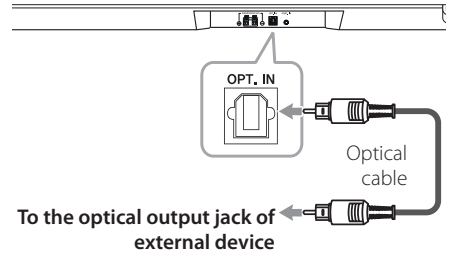

### Speaker (easy) setup

Listens to sound from TV, DVD or Digital Device with 2.1 or 2 ch mode.

1. Connect the OPT. IN jack on the back of the unit to optical out jack of your TV (or digital device etc.)
2. Set the input source to OPTICAL IN. Press **OPTICAL** on the remote control or **F** on the unit until the function is selected.
3. Listen to sound with 2.1 or 2 ch speaker.

## Operations

### DRC (Dynamic Range Control)

Make the sound clear when the volume is turned down (Dolby Digital only). This function turns on or off each time you press **DRC ON/OFF**.

### Turn off the sound temporarily

Press  to mute your unit.

To cancel it, press  again on the remote control or change the volume level.

### AUTO POWER On/Off

This function automatically turns on/off the unit when you turn on/off the TV or the external device (DVD Player, Blu-ray Disc Player, etc.) connected to this unit.

It is supported only on OPTICAL and LG TV functions.

This function turns on or off each time you press **AUTO POWER ON/OFF**.

#### Note

- After the unit is turned on by AUTO POWER function, it will be automatically turned off if there is no signal for a certain period of time from the TV connected by LG Sound Sync (Optical/Wireless).
- After the unit is turned on by AUTO POWER function, it will be automatically turned off if there is no signal for a certain period of time from the external device connected by an optical cable.
- If you turned off the unit directly, it cannot be turned on automatically by AUTO POWER function. However the unit can be turned on by AUTO POWER function when optical signal comes in after 5 seconds of no signal.
- Depending on the connected device, this function may not operate.
- In Bluetooth mode, this unit may be turned on by AUTO POWER setting depending on the connected Bluetooth device and then LG TV function is selected.  
In this case the unit will be turned off automatically and when you restart the unit, it will be turned on by LG TV function.

## Auto power down

This unit will power off itself to save electric consumption in the case main unit is not connected to external device and is not used for 20 minutes.

So does this unit after six hours since Main unit has been connected to other device using analog input.

## LG Sound Sync



You can control some functions of this unit by your TV's remote control with LG Sound Sync. It is compatible with the LG TV that supports LG Sound Sync. Make sure of the LG Sound Sync logo on your TV.

Controllable function by LG TV's remote control :  
Volume up/down, mute

Refer to the TV's instruction manual for the details of LG Sound Sync.

Make one of the following connections, depending on the capabilities of your equipment.

### ! Note

- You can also use the remote control of this unit while using LG Sound Sync. If you use TV's remote control again, the unit synchronizes with the TV.
- When the connection fails, make sure of the condition of the TV and power.
- Make sure of the condition of this unit and the connection in the cases below when using LG Sound Sync.
  - Turn off the unit.
  - Changing the function to the others.
  - Disconnecting the optical cable.
  - Disconnecting the wireless connection caused by interference or a distance.
- The amount of time to turn off this unit is different depending on your TV when you set AUTO POWER function to ON.

## With wired connection

1. Connect your LG TV to the unit by using an optical cable.

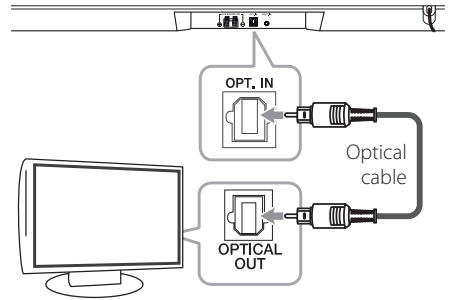

2. Set up LG Sound Sync (Optical) on the TV. Refer to the TV's instruction manual.
3. Turn on the unit by pressing **⏻** (Power) on the remote control.
4. Select OPTICAL IN function by using **OPTICAL** on the remote control or **F** on the unit until the function is selected.

TV sound will be outputted from the soundbar if connecting normally between this unit and your TV.



### With wireless connection

1. Turn on the unit by pressing  (Power) on the remote control.
2. Select LG TV function by using **LG TV** on the remote control or **F** on the unit until the function is selected.
3. Set up LG Sound Sync (Wireless) on the TV. Refer to the TV's instruction manual.

LG TV LED will be turned on for 3 seconds and turned off when unit is completely connected to TV.



#### Note

If you turned off the unit directly by pressing  (Power), LG Sound Sync (Wireless) will be disconnected. To use this function again, you should reconnect the TV and the unit.

## Using Bluetooth technology

### About Bluetooth

Bluetooth is wireless communication technology for short range connection.

The sound may be interrupted when the connection interfered by the other electronic wave or you connect the bluetooth in the other rooms.

Connecting individual devices under **Bluetooth®** wireless technology does not incur any charges. A mobile phone with **Bluetooth®** wireless technology can be operated via the Cascade if the connection was made via **Bluetooth®** wireless technology.

Available Devices : Mobile phone, MP3, Laptop, PDA etc.

### Bluetooth Profiles

In order to use **Bluetooth®** wireless technology, devices must be able to interpret certain profiles. This unit is compatible with following profile.

A2DP (Advanced Audio Distribution Profile)

## Listening to music stored on the Bluetooth devices

### Pairing your unit and Bluetooth device

Before you start the pairing procedure, make sure the Bluetooth feature is turned on in to your Bluetooth device. Refer to your Bluetooth device's user guide. Once a pairing operation is performed, it does not need to be performed again.

1. Select the Bluetooth function by using  on the remote control or **F** on the unit until the function is selected. Bluetooth LED will blink.
2. Operate the Bluetooth device and perform the pairing operation. When searching for this unit with the Bluetooth device, a list of the devices found may appear in the Bluetooth device display depending on the type of Bluetooth device. Your unit appears as "LG SOUND BAR (XX:XX)".

#### ! Note

- XX:XX means the last four digits of BT address. For example, if your unit has a BT address such as 9C:02:98:4A:F7:08, you will see "LG SOUND BAR (F7:08)" on your Bluetooth device.
- Depending on the Bluetooth device type, some device have a different pairing way. Enter the PIN code (0000) as needed.

3. When this unit is successfully connected with your Bluetooth device, Bluetooth LED Will be turned on for few second and turned off.
4. Listen to music.  
To play a music stored on your Bluetooth device, refer to your Bluetooth device's user guide.

#### ! Note

- When using **Bluetooth®** technology, you have to make a connection between the unit and the bluetooth device as close as possible and keep the distance. However it may not work well in the case below :
  - There is a obstacle between the unit and the bluetooth device.
  - There is a device using same frequency with **Bluetooth®** technology such as a medical equipment, a microwave or a wireless LAN device.
- This unit supports Bluetooth auto pairing. However it does not operate in the case below :
  - When you restart this unit.
  - After using LG TV function, auto pairing does not operate.
- The sound may be interrupted when the connection interfered by the other electronic wave.
- You cannot control the Bluetooth device with this unit.
- Pairing is limited one Bluetooth device per one unit and multi-pairing is not supported.
- Depending on the type of the device, you may not be able to use the Bluetooth function.
- You can enjoy wireless system using phone, MP3, Notebook, etc..
- The more distance between the unit and the bluetooth device, the lower the sound quality becomes.
- Bluetooth connection will be disconnected when the unit is turned off or the bluetooth device gets far from the unit.
- When Bluetooth connection is disconnected, connect the bluetooth device to the unit again.

## Sound adjustment

### Setting sound effect

This system has a number of pre-set surround sound fields. You can select a desired sound mode by pressing each effect button.

The displayed items for the equalizer may be different depending on sound sources and effects.

Mode	Description
STANDARD	You can enjoy the sound without equalizer effect.
MUSIC	You can enjoy comfortable and natural sound.
CINEMA	You can enjoy more immersive and cinematic surround sound.

#### Note

- In some of surround modes, some speakers, there's no sound or low sound. It depends on the mode of surround and the source of audio, it is not defective.
- You may need to reset the surround mode, after switching the input, sometimes even after the sound file changed.

### Adjust volume level automatically

This unit supports Auto volume function that automatically adjusts the volume level.

When the output sound is too loud or too low, press **AUTO VOL ON** on the remote control. So you can enjoy the sound with appropriate levels.

To cancel this function, press **OFF** button.

### Adjust the woofer level settings

You can adjust the sound level of woofer from -40 dB to 6 dB.

Press **WOOFER LEVEL-** or **WOOFER LEVEL+** to adjust the sound level of the woofer.

## Controlling a TV with the supplied remote control

You can control your TV using the buttons below.  
(LG TV only.)

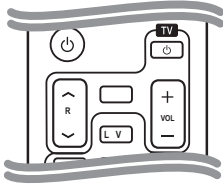

Button	Operation
<b>INPUT</b>	Switch the TV's input source between the TV and other input sources.
⏻ (TV Power)	Turn the TV on or off.
<b>VOL +/-</b>	Adjust the volume of the TV.
<b>PR/CH ^ / V</b>	Scan up or down through memorized channels.

### ! Note

- Depending on the TV being connected, you may not be able to control your TV using some of the buttons.
- The remote control of the unit performs basic operation of your TV. Please use the TV's remote control to enjoy advanced operation of your TV.

# Troubleshooting

PROBLEM	CAUSE & CORRECTION
The unit does not work properly.	<ul style="list-style-type: none"> <li>• Turn off the power of this unit and the connected external device (TV, Woofer, DVD-player, Amplifier, etc.) and turn it on again.</li> <li>• Disconnect the power cord of this unit and the connected external device (TV, Woofer, DVD-player, Amplifier, etc.) and then try connecting again.</li> </ul>
No Power	<ul style="list-style-type: none"> <li>• The power cord is unplugged. Plug in the power cord.</li> <li>• Check the condition by operating other electronic devices.</li> </ul>
No sound	<ul style="list-style-type: none"> <li>• Incorrect input source is selected. Check the input source and select the correct input source.</li> <li>• The mute function is activated. Press  or adjust the volume level to cancel the mute function.</li> </ul>
No woofer sound	<ul style="list-style-type: none"> <li>• Unit and subwoofer are disconnected. Connect the unit and the subwoofer. (Refer to the page 13.)</li> </ul>
The remote control does not work properly.	<ul style="list-style-type: none"> <li>• The remote control is too far from the unit. Operate the remote control within about 7 m (23 ft).</li> <li>• There is an obstacle in the path of the remote control and the unit. Remove the obstacle.</li> <li>• The batteries in the remote control is exhausted. Replace the batteries with new one.</li> </ul>
The AUTO POWER function does not work.	<ul style="list-style-type: none"> <li>• Depending on the connected device, this function may not operate.</li> </ul>
When you feel the output sound of the unit is low.	<p>Check the details below and adjust the unit according to them.</p> <ul style="list-style-type: none"> <li>• Switch [ON] state of DRC function to [OFF] by using remote controller.</li> <li>• With the sound bar connected with TV, change the AUDIO DIGITAL OUT setting on TV Setup Menu from [PCM] to [AUTO] or [BITSTREAM].</li> <li>• With the sound bar connected with Player, change the AUDIO DIGITAL OUT setting on Player Setup Menu from [PCM] to [PRIMARY PASS-THROUGH] or [BITSTREAM].</li> <li>• Change Audio DRC setting on Player setup menu to [OFF] state.</li> </ul>

# Specifications

General (NB2540)	
Power requirements	Refer to the main label on the unit.
Power consumption	Refer to the main label on the unit.
Dimensions (W x H x D)	880 mm x 62 mm x 90 mm
Net Weight (Approx.)	1.8 kg
Operating temperature	5 °C to 35 °C
Operating humidity	5 % to 90 %

Input/Output	
OPT. IN	3 V (p-p), Optical jack x 1
PORT. IN	0.5 Vrms (3.5 mm stereo jack) x 1
Available Digital Input Audio Sampling Frequency	32 kHz, 44.1 kHz, 48 kHz, 96 kHz

Amplifier	
Total	120 W
Front	25 W x 2 (4 Ω at 1 kHz)
Subwoofer	70 W (4 Ω at 100 Hz)
THD	10 %

Subwoofer (S24A1-W)	
Type	1 Way 1 Speaker
Impedance	4 Ω
Rated Input Power	70 W
Max. Input Power	140 W
Dimensions (W x H x D)	156 mm x 300 mm x 294 mm
Net Weight (Approx.)	2.9 kg

- Designs and specifications are subject to change without prior notice.

## Trademarks and licenses

---



Manufactured under license from Dolby Laboratories. Dolby and the double-D symbol are trademarks of Dolby Laboratories.



For DTS patents, see <http://patents.dts.com>. Manufactured under license from DTS Licensing Limited. DTS, the Symbol, & DTS and the Symbol together are registered trademarks, and DTS 2.0 Channel is a trademark of DTS, Inc. © DTS, Inc. All Rights Reserved.



**Bluetooth**® wireless technology is a system which allows radio contact between electronic. Connecting individual devices under **Bluetooth**® wireless technology does not incur any charges. A mobile phone with **Bluetooth**® wireless technology can be operated via the Cascade if the connection was made via **Bluetooth**® wireless technology.

The **Bluetooth**® word mark and logos are owned by the **Bluetooth**® SIG, Inc. and any use of such marks by LG Electronics is under license.

Other trademarks and trade names are those of their respective owners.

---

## Maintenance

### Handling the unit

#### When shipping the unit

Please save the original shipping carton and packing materials. If you need to ship the unit, for maximum protection, re-pack the unit as it was originally packed at the factory.

#### Keeping the exterior surfaces clean

- Do not use volatile liquids such as insecticide spray near the unit.
- Wiping with strong pressure may damage the surface.
- Do not leave rubber or plastic products in contact with the unit for a long period of time.

#### Cleaning the unit

To clean the player, use a soft, dry cloth. If the surfaces are extremely dirty, use a soft cloth lightly moistened with a mild detergent solution. Do not use strong solvents such as alcohol, benzine, or thinner, as these might damage the surface of the unit.

