

WORK	SEC.	甲	乙	丙	PRINTING DEGREE		MATERIAL AND PRINTING DESCRIPTION	LG MODEL NAME	LANGUAGE	PAGE	REMARK
	BRAND	MODEL	P/NO.	EXTERIER	INTERIER						
52		WF-HXB110FS	MFL67568752 ver.052115.00	1	1	材质: 70g 双层纸	T9532HFCP6.AFSREML	English	44	Sapience English Panel	

<<备注 >>

1. 材质，印刷，尺寸参照作业表.
2. 印刷，文字大小和线条以LG设计基准.
3. 数字大小依据一般规格.
4. 批量生产前取的设计限度.
5. 本部品不应含有禁止物质 (Pb, Cd, Hg, Cr+6, PBB, PBDE)，详细内容满足LGEPN-Z-1023.

<< NOTES >>

1. Material,printing and exterier size are refer to work tables.
2. Printing, tsxt size and line are based on LG desing film.
3. Exterier size on the drawing is cutting line.
4. Before product controlled by criteria sample.
5. The part should not contain prohibited substances(Pb,Cd,Hg,Cr+6,PBB,PBDE) and detailsShould comply with LGEPN-Z-1023.

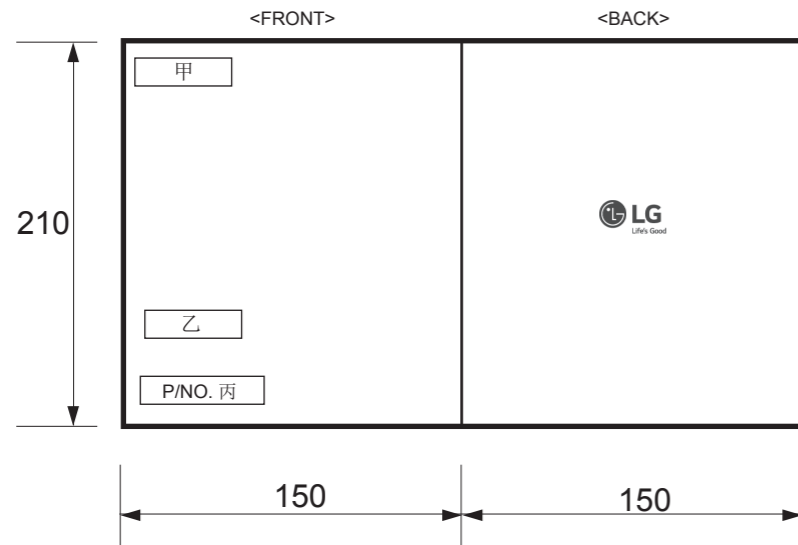

REV.No.	REVISION DESCRIPTION	RER.NO.	DATE	PREPARED	APPROVALED

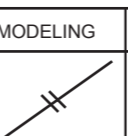
Unit		mm	SCALE	1/1	TITLE	MANUAL, OWNER'S DRUM-EXPORT 1/1
MODELING	DESIGNED	REVIEWED	CHECKED	APPROVALED		
	顾政	盛晓旦	王莹莹	黄圣起	DWG. No.	MFL67568752
LGEPN LG Electronics Inc.			RELATED DRAWING			



OWNER'S MANUAL

WASHING MACHINE

Please read this manual carefully before operating your washing machine and retain it for future reference.

WF-HXB110FS



MFL67568752
ver.052115.00

www.lg.com

Product Features



The Turbo Drum DD washing machine does not operate with the lid open.

If the lid is opened during wash, rinse and spin cycles, the machine will stop automatically.



Please close the door gently. Closing the door in an aggressive manner can cause damage and/or injury.

Smart Drum achieved by DD Motor Technology



- Smart Drum with Drum Washing Type is a more hygienic and cleaner washer tub that protects the fabric and prevents damages.

Normal logic control

- A built-in load sensor automatically detects and measures the laundry load and a microprocessor optimizes washing conditions such as ideal water consumption and washing time.
- Advanced technology is built into the Electronic Control System which ensures the best washing result.

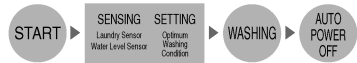

New DD type washing with fabric care



Fast revolution accelerates detergent dissolving and soaking thoroughly into the clothes.



Laundry blade revolution to either side in turn to remove stains in the laundry.



Fast revolution of tub creates the current of water.



Tub rotates to either side to balance and unwind laundry.

Low Noise Direct Drive System

- The advanced Brushless DC motor rotates the Tub directly without belt and clutch, thereby reducing the noise of the washer.
- The washing machine adjusts to optimum speed according to the type of clothing in the load.



SmartDiagnosis™

- It is the technology to transmit the anomalies to the service center when there is a problem with the washer. It provides the service that gives faith and trust to the customers through precise and fast analysis.



Contents

READ THIS MANUAL

Inside you will find many helpful hints on how to use and maintain your washer properly. Just a little preventive care on your part can save you a great deal of time and money over the life of your washer. You will find many answers to common problems in the Troubleshooting section. If you review our chart of Troubleshooting Tips first, you may not need to call for service at all.

Introduction	Safety Information	4
	Identification of Parts	7
	Function Information	8
Before Starting to Wash	Preparation Before Washing	9
	Use of Water, Dispenser Drawer, Detergent, Bleach and Softener	10
	Special Guide for Stain Removal	13
	Function of each Button	14
Washing Course	Normal Wash	16
	Smart Rinse	16
	Eco Wash	16
	Quick Wash	16
	Delicates Wash	16
	School Care Wash	18
	Duvet Wash	18
	Pre Wash+Normal Wash	18
	Favorite Wash	20
	Soak Wash	21
	Intensive Rinse	22
Additional Function Course	Tub Clean	23
	Air Dry	24
	Option Washing	25
	Time Delay (RESERVATION) Wash	26
	Other Useful Functions	27
Installation	Placing and Leveling	28
	Connecting Water Supply Hose	29
	Connecting Drain Hose	32
Care and Maintenance	Grounding Method	33
	Cleaning and Maintenance	34
	Soft Safety Door	36
Troubleshooting	Common washing problems	37
	Troubleshooting	38
	SmartDiagnosis™	39
Terms of Warranty	Terms of Warranty	40
Specification	Specification	41

Safety Information

Read carefully and thoroughly through this booklet as it contains important safety information that will protect the user from unexpected dangers and prevent potential damages to the product.

This booklet is divided into 2 parts : Warning and Caution.



: This is a warning sign specifying user's applications which might be dangerous.





: This is a sign specifying 'Strictly Forbidden' applications.









WARNING : Failure to comply with the instructions under this sign may result in major physical injuries or death.











CAUTION : Failure to comply with the instructions under this sign may result in minor physical injuries or damages to the product.

<p>WATER HEATER SAFETY</p>	<p> WARNING</p> <ul style="list-style-type: none"> • Under certain conditions hydrogen gas may be produced in a water heater that has not been used for two weeks or more. Hydrogen gas can be explosive under these circumstances. If the HOT water has not been used for two weeks or more, prevent the possibility of damage or injury by turning on all Hot water faucets and allowing them to run for several minutes. Do this before using any electrical appliance which is connected to the HOT water system. This simple procedure will allow any built-up hydrogen gas to escape. Since the gas is flammable, do not smoke or use an open flame or appliance during this process.
<p>PROPER INSTALLATION</p>	<p> CAUTION</p> <ul style="list-style-type: none"> • The base opening must not be obstructed by carpeting when the washing machine is installed on a carpeted floor. • Install or store where it will not be exposed to temperatures below freezing or exposed to the weather. If the product is exposed to such conditions, electric shock, fire, break down or deformation may occur. • Properly ground washer to conform with all governing codes and ordinances. Follow details in Installation Instructions. If not grounded properly, break down and leakage of electricity may occur, which may cause electric shock. • Must be positioned so that the plug is accessible. If the plug is placed between the wall and the machine, it may get damaged, possibly causing fire or electric shock. • Make sure the plug is completely pushed into the outlet. Failure to do so may cause electric shock and fire due to overheating.

Safety Information

<p>YOUR LAUNDRY AREA</p>	<p> WARNING</p> <ul style="list-style-type: none">• Keep the area underneath and around your appliances free of combustible materials such as lint, paper, rags, chemical, etc. Operating with such materials around the machine may trigger explosion or fire.• The appliance is not intended for use by young children or infirm persons without supervision.• Young Children should be supervised to ensure that they do not play with appliance. There is potential danger that children might drown in the tub. <p> Do not touch the power plug with a wet hand. It will cause electric shock</p> <p> Do not put your hand, foot or anything under the washing machine while the washing machine is in operation. There is a rotating mechanism under the machine, so you could be injured.</p>
<p>WHEN USING THE WASHER</p>	<p> CAUTION</p> <ul style="list-style-type: none">• Use this appliance only for its intended purpose as described in this Owner's Manual.• The laundry process can reduce the flame retardancy of fabrics. To avoid such a result, carefully follow the garment manufacturer's wash and care instructions.• To minimize the possibility of electric shock, unplug this appliance from the power supply or disconnect the washer at the household distribution panel by removing the fuse or switching off the circuit breaker before attempting any maintenance or cleaning. <p>NOTE : Pressing Circuit button to turn off DO NOT disconnect the appliance from the power supply.</p> <ul style="list-style-type: none">• Make sure that drainage is working properly. If water is not drained properly, your floor may get flooded. Flooded floors may induce electricity leakage, further resulting in electric shock or fire.• If, during spinning, opening the lid does not stop the tub within about 15 seconds, immediately discontinue operating the machine. Call for repair. A machine that spins with its door open may cause injuries. <p> Never reach into washer while it is moving. Wait until the machine has completely stopped before opening the lid. Even slow rotation can cause injury.</p> <p> Never attempt to operate this appliance if it is damaged, malfunctioning, partially disassembled, or has missing or broken parts, including a damaged cord or plug. Operating with a damaged plug may cause electric shock.</p> <p>Do not use water hotter than 50°C.</p> <p> Use of excessively hot water may cause damage to fabrics or cause leakage of water.</p>

Safety Information

<p>WHEN USING THE WASHER</p>	<p> WARNING</p> <p> Do not use a plug socket and wiring equipment for more than their rated capacity. Exceeding the limit may lead to electric shock, fire, break down, and/or deformation of parts.</p> <p> Do not mix chlorine bleach with ammonia or acids such as vinegar and/or rust remover. Mixing different chemicals can produce toxic gases which may cause death.</p> <p> Do not wash or dry articles that have been cleaned in, washed in, soaked in, or spotted with combustible or explosive substances (such as wax, oil, paint, gasoline, dry-cleaning solvents, kerosene, etc). Do not add these substances to the wash water. Do not use or place these substances around your washer or dryer during operation. It may ignite or explode.</p>
<p>WHEN NOT IN USE</p>	<p> CAUTION</p> <ul style="list-style-type: none">• Turn off water faucets to relieve pressure on hoses and valves and to minimize leakage if a break or rupture should occur. Check the condition of the fill hoses; they may need replacement after 5years.• When the air temperature is high and the water temperature is low, condensation may occur and thus wet the floor.• Wipe off dirt or dust on the contacts of the power plug. Using unclean power plug may cause fire.• Before discarding a washer, or removing it from service, remove the washer lid to prevent children from hiding inside. Children may be trapped and suffocated if the lid is left intact. <p> Do not attempt to repair or replace any part of this appliance unless specifically recommended in this Owner's Manual, or in published user-repair instructions that you understand and have the skills to carry out. Operating the machine with improperly replaced parts may be a cause for fire or electric shock.</p> <p> Do not tamper with controls. It may lead to electric shock, fire, break down, deformation.</p> <p> Do not yank the power cord in an attempt to disconnect the power plug. Securely hold the power plug to unplug the machine. Failure to observe these instructions may cause electric shock or fire due to short-circuit.</p> <p> When you are cleaning the washing machine, do not apply water directly to any part of the washing machine. It will cause short circuit and electric shock.</p>

Identification of Parts

Body

* Picture might be different by model.

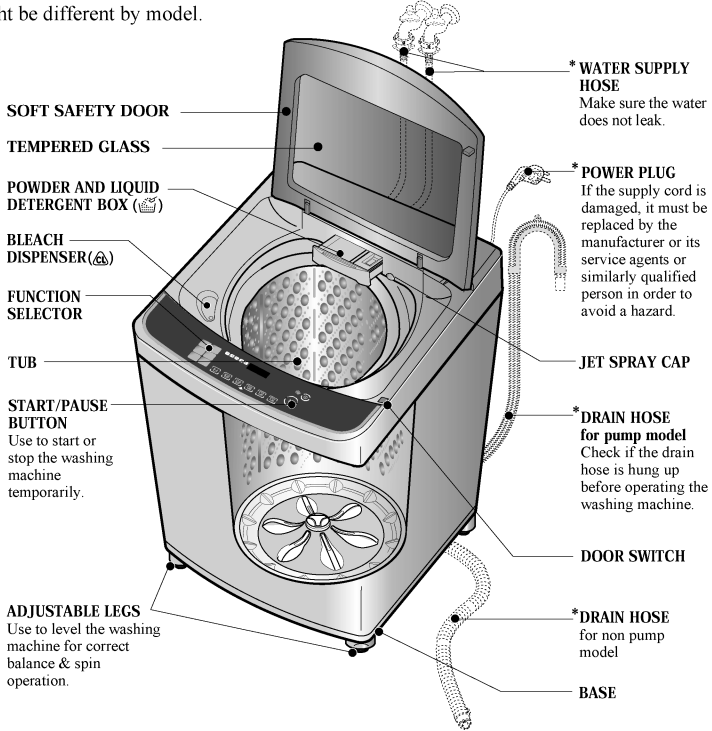

Accessories

Water supply hoses

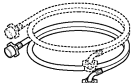

or

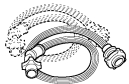

1 Each for COLD and HOT water

Drain hose



or



Anti-rat cover (option)

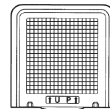

Fixing screw for Anti-rat cover

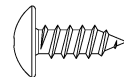

NOTE

* * Part can be different according to the model.

Function Information

Our machine provides various washing methods which suits various conditions and types of laundry.

Different types of laundry washing

Normal Wash

Use this Course for everyday washing e.g. sheets, towels, T-shirts. *(refer to page 16)*

Smart Rinse

Use this Course to get better rinsing performance. *(refer to page 16)*

Eco Wash

To save water and detergent for less than 7kg of laundry that is not too dirty. *(refer to page 16)*

Delicates Wash

Wool clothes (lingerie, wool, etc.) which may be easily damaged can be washed. *(refer to page 16)*
The fibers of machine washable woollens have been specifically modified to prevent felting when they are machine washed. Most handknitted garments are not made of machine washable wool and we recommend that you hand wash them

- Before washing your woollens check the care label for the washing instructions.
- When washing woollens use a mild Detergent recommended for washing wool.
- Hand washed woollens may be spun in a washing machine to reduce the time they take to dry.
- To dry woollens lay down them flat on a towel and pat into shape. Dry woollens out of direct sunlight. (The heat and tumble action of a dryer may cause shrinkage or felting of woolen garments.) Some wool underlays and sheepskin products can be washed in a washing machine but may cause pump blockages. (Ensure that the whole article is suitable for machine washing and not just the backing material.) You may wish to handwash these articles and place them in the machine to spin dry.

School Care Wash

Use this Course to wash School Uniform. *(refer to page 18)*

Duvet Wash

Use for blanket or duvet with (hand wash) sign. *(refer to page 18)*

Pre Wash+Normal Wash

Washing laundry with Pre Wash+Normal cycle that pretreats immediate stain without hand-wash. *(refer to page 18)*

Favorite Wash

This setting allows you to store your Favorite wash conditions in the normal cycle memory. *(refer to page 20)*

Washing according to the condition of laundry

Quick Wash

Quick Wash can be selected to wash lightly soiled clothes of less than 3.0 kg in a short time. *(refer to page 16)*

Soak Wash

Soak Wash can be selected to wash heavily soiled laundry by soaking in water for some time to remove dirt and grime. *(refer to page 21)*

Intensive Rinse

Use Intensive Rinse to remove detergents more effectively. *(refer to page 22)*

Other washing method

Tub Clean

Use this Course to clean the inside of washing machine especially Inner tub & Outer tub. *(refer to page 23)*

Time Delay (RESERVATION) Wash

Time Delay (RESERVATION) Wash is used to delay the finishing time of the operation. The number of hours to be delayed can be set by the user accordingly. *(refer to page 26)*

Option Wash

When the user needs only Spin, Rinse/Spin, Rinse, Wash/Rinse, Wash, Wash/Rinse/Spin, Soak/Wash/Rinse/Spin *(refer to page 25)*

Preparation Before Washing

Care Labels

* Look for a care label on your clothes. This will tell you about the fabric content of your garment and how it should be washed.

Sort clothes into loads that can be washed with the same wash cycle, Water Temperature and spin speed.



Sorting

To get the best results, different fabrics need to be washed in different ways.

- **SOIL** (Heavy, Normal, Light) Separate clothes according to the type and amount of soil.
- **COLOR** (Whites, Lights, Darks) Separate white fabrics from colored fabrics.
- **LINT** (Lint producers, Collectors) Separate lint producers and lint collectors.
Lint Producers Terry cloth, Chenille, Towels, Nappies, Diapers
Lint Collectors Synthetics, Corduroy, Permanent Press, Socks



Check before Loading

- **Check all pockets to make sure that they are empty.** Things such as nails, hairclips, matches, pens, coins, and keys can damage both your washer and your clothes.
- **Mend any torn garments or loose buttons.** Tears or holes may become larger during washing.
- Remove belts, underwires, etc. to prevent damage to the machine or your clothes.
- **Pre-treat any dirt and stains.**
- Make sure the clothes are washable in water.
- Check the washing instructions.
- Remove tissue in pockets.



⚠ CAUTION

Do not wash or spin any item labeled or known to be water-proof or water-resistant, even if the product care label on the item permits machine washing. Failure to follow these instructions could result in severe damage to your laundry, your washer and/or property damage as a result of abnormal vibration of the washer.

- Examples of water-proof or water-resistant items include certain mattress pads, mattress covers, rain gear, camping gear, skiing apparel, outdoor gear and similar items.

Pretreatment on stains or heavy soil

- Use 'PreWash+Normal' cycle for very soiled clothes.
- In case of heavily soiled clothes, pretreatment may require before the cycle.
- Pretreat shirt collars and cuffs with a pre-wash product or liquid Detergent when placing them in the washer. Before washing treat special stains with bar soaps, liquid Detergent or a paste of water and granular Detergent.
- Use a pretreat soil and stain remover.
Treat stains AS SOON AS POSSIBLE. The longer they are left the harder they are to remove. *(For more detail refer to page13)*

Loading

Do not wash fabrics containing flammable materials (waxes, cleaning fluids, etc.).

Load Size

The WATER LEVEL should just cover the clothes. Adjust the load size accordingly. Loosely load clothes no higher than the top row of holes in the washer tub. To add items after washer has started, press Start button and submerge additional items. Close the lid and press Start button again to restart.

Light and Large-sized clothing

Clothes like downs and woollens are light weight, large and float easily. Use a nylon net and wash them in a small amount of water. If the laundry floats during the wash cycle, it may become damaged. Use dissolved Detergent to prevent the Detergent from clumping.

Long laundry items

Use nylon nets for long, DELICATE items. For laundry with long strings or long length, a net will prevent tangling during washing. **Fasten zippers, hook, and strings** to make sure that these items don't snag on other clothes.

※ Nylon net is not supplied by LG.

⚠ WARNING

Fire Hazard

Never place items in the washer that are dampened with gasoline or other flammable fluids. No washer can completely remove oil. Do not dry anything that has ever had any type of oil on it (including cooking oils). Doing so can result in death, explosion, or fire.

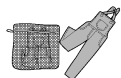

Use of Water, Dispenser Drawer, Detergent, Bleach and Softener

Using Water

Amount of WATER LEVEL

- This machine detects the quantity of laundry automatically, then sets the Water Level and proper amount of Detergent.
- When you select a wash Course, the Water Level will be shown on the control panel.
- The following table shows the amount of water.
- When the Water Level is automatically detected, it may differ depending on the quantity of laundry even though the same Water Level is indicated on the control panel.

9	10	
7	8	
5	6	
3	4	
1	2	

NOTE

[Minimum water amount]

It depends on laundry load and washer model. Or manually you can pour a certain amount water into tub directly to some height. That's because if water level reaches to the some height sensed by washer itself, washer automatically operates. In other words, it is needed to pour water to the point when washer starts operating.

Water Temperature (for 2 valve model)

- The machine sets the appropriate temperature automatically according to the wash Course.
- The temperature of the water impacts the effectiveness of all laundry additives and therefore, the cleaning results.
We recommend temperatures of:
 - HOT 49~60°C... (120-140°F) White items, diapers, underclothing and heavily soiled, colorfast items.
 - WARM 29~40°C... (85-105°F) Most items
 - COLD* 18~24°C... (65-75°F) Only very bright colors with light soil.
- When washing in COLD water additional steps may be needed:
 - Adjust Detergent amount and pre-dissolve Detergent in WARM water
 - Pretreat spots and stains
 - Soak heavily soiled items
 - Use appropriate bleach

* Temperature below 18°C... (65°F) will not activate laundry additives and may cause lint, residue, poor cleaning, etc.

In addition, Detergent manufactures and care labels define COLD water as 26~29°C... (80-85°F).

If the temperature of the water in the tub is too cold for your hands, the Detergent will not activate and clean effectively.

NOTE

If iron is present in the water the clothes may become an all-over yellow or they may be stained with brown or orange spots or streaks. Iron is not always visible. Installation of water softener or an iron filter may be necessary for severe cases.

Using Dispenser Drawer

Using the Dispenser Drawer

The dispenser drawer contains 2 compartments:

- Liquid Fabric Softener
- Powder Low-Sudsing, High-Efficiency Detergent

The dispenser automatically dispenses additives at the proper time in the wash cycle.

1. Slowly open the dispenser drawer by pulling the drawer out until it stops.

2. After adding laundry products, slowly close the dispenser drawer. Closing the drawer too quickly could result in early dispensing of additives.

- Avoid overfilling or splashing when adding laundry products to the dispenser. Doing so could result in early dispensing of laundry products.

At the end of the cycle, you may see water in the compartments. This is part of the normal operation of the washer.

NOTE : Do not use bleach in the dispenser drawer.

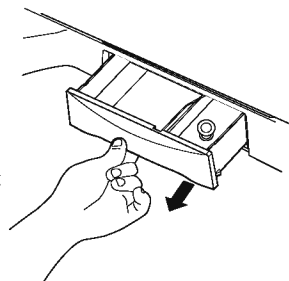

Using Detergent

Detergent

Follow the Detergent package directions. Using too little Detergent is a common cause of laundry problems. Use more Detergent if you have hard water, large loads, greasy or oily soils or lower Water Temperature.

Choosing the right Detergent

We recommend the use of domestic Detergent, (powder, liquid or concentrated). Soap flakes or granulated soap powders should not be used in your washing machine. When washing woolens remember to use Detergent suitable.

How much Detergent

The correct amount of Detergent will vary depending on the amount of soil in your clothes (Jeans and work clothes may need more Detergent, while bath towels usually need less.).

For liquid and concentrated Detergents, follow the recommendations of the Detergent manufacturer.

Note: To check you are using the correct amount of Detergent, lift the lid of your machine about half-way through the wash. There should be a thin layer of foam over the surface of the water. Lots of foam may look good, but it does not contribute to cleaning your clothes. No foam means not enough Detergent has been used; soil and lint can settle back on the clothes or the washing machine.

If excess Detergent is used, the rinse will not be as clean and efficient. Also, it could cause environmental pollution, so use it accordingly.

Adding Detergent

Add measured detergent to the detergent compartment of the dispenser drawer.

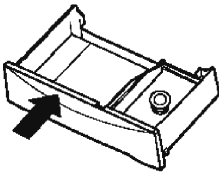

Detergent is flushed through the dispenser at the beginning of the wash phase.

Detergent usage may need to be adjusted for water temperature, water hardness, size and soil level of the load.

Avoid using too much detergent in your washer, as it can lead to oversudsing and detergent residue being left on the clothes.

Note : Using Liquid detergent

- Dilute Liquid detergent with water and pour into the tub, start the cycle.

- Delay wash course is not available if you use liquid detergent.



Attention

Using liquid detergent without diluting, or leaving laundry for a long time after pouring diluted liquid detergent into the tub might cause damage, bleaching or discoloration of cloth.

Use of Water, Dispenser Drawer, Detergent, Bleach and Softener

Using Liquid Bleach

- Check clothing care label for special instructions and separate the laundry to be bleached
- Dilute liquid chlorine bleach.
- Measure the recommended amount of liquid bleach carefully following instructions on the bottle.
- Before starting the washer, pour measured amount of bleach directly into bleach dispenser. Avoid splashing or overfilling. Powdered bleach should be mixed with water before pouring.

Bleach dispenser (Ⓐ)

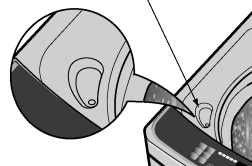

NOTE

- Never pour undiluted liquid bleach directly onto clothes or into the wash basket.
This may cause change of color or damage the laundry.
- Do not pour powdered bleach into bleach dispenser.

Using Fabric Softener

If desired, pour the recommended amount of liquid fabric softener into the right-hand compartment.

Use only liquid fabric softener.

Dilute with water to the maximum fill line.

- Do not exceed the maximum fill line.

Overfilling can cause early dispensing of the fabric softener, which could stain clothes.

NOTE : Do not pour fabric softener directly on the wash load. It may stain the clothes.

: Fabric softener is automatically dispensed in the final rinse with indication beep.

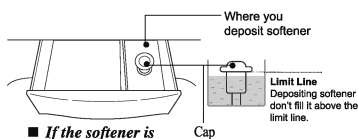

■ **If the softener is over filled, it can overflow.**

Attention

- Do not mix with Detergent or bleach.
- Never pour fabric softener directly on clothes. It may stain them.
- Do not stop the washer during the first spin for timely dispensing.
- Option washing is not designed to be used with fabric softener dispenser.

Scrud(Waxy Build up)

Scrud is the name given to the waxy build-up that can occur within any washer when the fabric softener comes into contact with Detergent. This build-up is not brought about by a fault in the machine.

If scrud is allowed to build-up in the machine it can result in stains on your clothes or an unpleasant smell in your washer.

If you wish to use fabric softener we recommend

- Using fabric softener sparingly.
- When filling the dispenser, do not splash or overfill.
- Clean dispenser as soon as the cycle is finished.
- Clean your machine regularly. (refer to page 23 or 34)
- Cold water washing increases the chance of this build-up occurring. We recommend a regular WARM or HOT wash e.g. every 5th wash should be at least a warm one.
- Fabric softener of thinner consistency is less likely to leave residue on the dispenser and contribute to a build-up.

Special Guide for Stain Removal

▲WARNING

- Do not use or mix liquid chlorine bleach with other household chemicals such as toilet cleaners, rust removers, acid or products containing ammonia. These mixtures can produce dangerous fumes which can cause serious injury or death.
- To reduce the risk of fire or serious injury to persons or property, comply with the basic warnings listed below:
 - Read and comply with all instructions on stain removal products.
 - Keep stain removal products in their original labeled containers and out of children's reach.
 - Thoroughly wash any utensil used.
 - Do not combine stain removal products, especially ammonia and chlorine bleach. Dangerous fumes may result.
 - Never wash items which have been previously cleaned in, washed in, soaked in or spotted with gasoline, dry cleaning solvents or other flammable or explosive substances because they give off vapors that could ignite or explode.
 - Never use highly flammable solvents, such as gasoline, inside the home. Vapors can explode on contact with flames or sparks.

For successful stain removal:

- Remove stains promptly.
Use 'PreWash+Normal' cycle for very soiled clothes.
In case of heavily soiled clothes, pretreatment may require before the cycle.
- Determine the kind of stain, then follow the recommended treatment in the stain removal chart below.
- To pretreat stains, use a prewash product, liquid Detergent, or a paste made from granular Detergent and water.
- Use COLD water on unknown stains because HOT water can set stains.
- Check care label instructions for treatments to avoid on specific fabrics.
- Check for colorfastness by testing stain remover on an inside seam.
- Rinse and wash items after stain removal.



Follow fabric care label instructions

Stain Removal	
STAIN	TREATMENT
Adhesive tape, chewing gum, rubber cement	Apply ice. Scrape off excess. Place stain face down on paper towels. Saturate with prewash stain remover or nonflammable dry cleaning fluid.
Baby formula, dairy products, egg	Use product containing enzymes to pretreat or soak stains.
Beverages (coffee, tea, soda, juice, alcoholic beverages)	Pretreat stain. Wash using COLD water and bleach safe for fabric.
Blood	Rinse with COLD water. Rub with bar soap. Or pretreat or soak with product containing enzymes. Wash using bleach safe for fabric.
Candle wax, crayon	Scrape off surface wax. Place stain face down between paper towels. Press with warm iron until wax is absorbed. Replace paper towels frequently. Treat remaining stain with prewash stain remover or nonflammable dry cleaning fluid. Hand wash to remove solvent. Wash using bleach safe for fabric.
Chocolate	Pretreat or soak in WARM water using product containing enzymes. Wash using bleach safe for fabric.
Collar or cuff soil, cosmetics	Pretreat with prewash stain remover or rub with bar soap.
Dye transfer on white fabric	Use packaged color remover. Wash using bleach safe for fabric.
Grass	Pretreat or soak in WARM water using product containing enzymes. Wash using bleach safe for fabric.
Grease, oil, tar (butter, fats, salad dressing, cooking oils, car grease, motor oils)	Scrape residue from fabric. Pretreat. Wash using hottest water safe for fabric. For heavy stains and tar, apply nonflammable dry cleaning fluid to back of stain. Replace towels under stain frequently. Rinse thoroughly. Wash using hottest water safe for fabric.
Ink	Some inks may be impossible to remove. Washing may set some inks. Use prewash stain remover, denatured alcohol or nonflammable dry cleaning fluid.
Mildew, scorch	Wash with chlorine bleach if safe for fabric. Or, soak in oxygen bleach and HOT water before washing. Badly mildewed fabrics may be permanently damaged.
Mud	Brush off dry mud. Pretreat or soak with product containing enzymes.
Mustard, tomato	Pretreat with prewash stain remover. Wash using bleach safe for fabric.
Nail polish	May be impossible to remove. Place stain face down on paper towels. Apply nail polish remover to back of stain. Repeat, replacing paper towels frequently. Do not use on acetate fabrics.
Paint, varnish	WATER BASED : Rinse fabric in cool water while stain is wet. Wash. Once paint is dry, it cannot be removed, OIL BASED AND VARNISH : Use solvent recommended on can label. Rinse thoroughly before washing.
Rust, brown or yellow discoloration	For spots, use rust remover safe for fabric. For discoloration of an entire load, use phosphate Detergent and nonchlorine bleach. Do not use chlorine bleach because it may intensify discoloration.
Shoe polish	LIQUID : Pretreat with a paste of granular Detergent and water. PASTE : Scrape residue from fabric. Pretreat with prewash stain remover or nonflammable dry cleaning fluid. Rub Detergent into dampened area. Wash using bleach safe for fabric.

Function of each Button

Display laundry progress

- Laundry progress is indicated here.
- Process to be done will have light on. Process in progress will blink and process already done will have light off.

Display remaining time, reservation time, and alarm for trouble

- During operation this indicates time to finish of laundry.
ex) **1:09** indicates remaining time of laundry, rinse, spin dry during operation/pause.
- If there is a trouble, it blinks with buzzer sound and indicates the source of trouble. It will work normally after troubleshooting.

Time Delay (Reservation) button

- Use for laundry reservation.
- To cancel, turn power off. (*refer to page 26*)

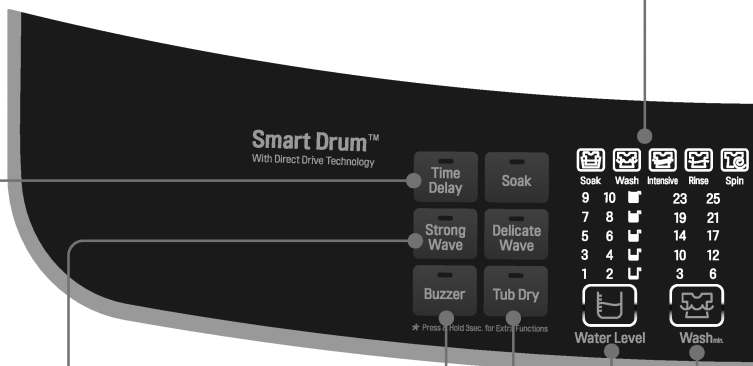

Water wave button

- To control water wave.
- Initially set at “medium” but will not be indicated. To control Strong wave power, press Strong wave. (all course except Allergy Care, Delicate, Silent and Tub Clean can adjust wave.)

Buzzer Button

- Pressing the button allows OFF ► ON.

Tub Dry Button

- Use this when you want to dry the empty tub after a wash.

Water Level button (display detergent amount)

- Use to adjust Water Level.
- It can be changed during operation.
- Add detergent as much as indicated amount next to Water Level.
- Detergent is based on condensed detergent.

NOTE

- * The standard detected by the sensor changing the algorithm is set by the normal standard. It may not be same to the washing habit of a specific user. So, it does not matter that the user uses it according to her/his washing habit.
- * The control panel may differ according to different models.

Air dry

- To shorten dry time.
- Air dry is a stand alone process.
- Press for 3 seconds to select, press power button to deselect. *(refer to page 24)*

START/PAUSE button

- Use to start or pause the washing process.
- After 4 minutes in pause status, it will automatically turn off.

SmartDiagnosis™ Function Display

- It marks the place to put the phone to receive signal when a problem occurs. *(refer to page 39)*

POWER button

- Use to turn the power on or off.
- Push again and power goes on or off.
- The power goes off automatically about 10 seconds after the wash is finished.

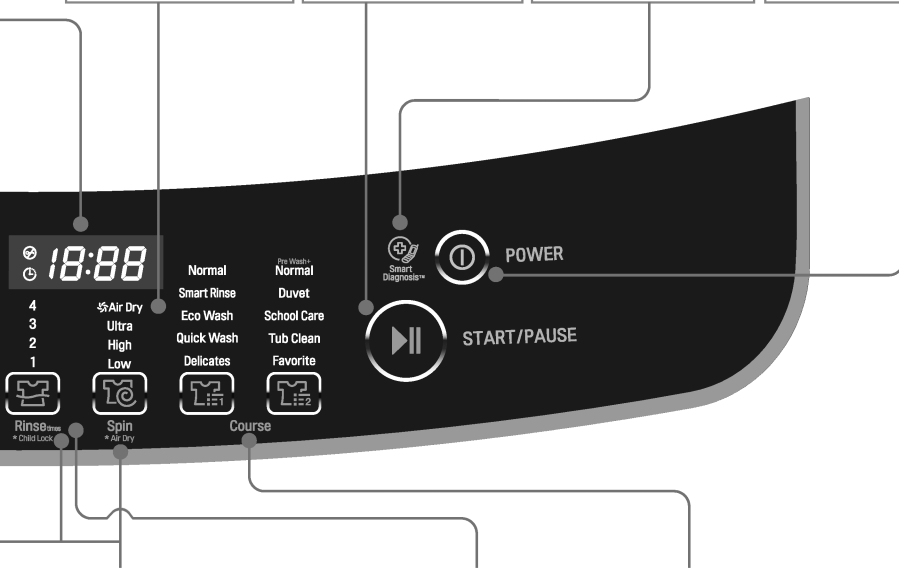

Wash, Rinse, Spin button

- To change laundry time, number of rinse, strength of spin dry.
- Use Intensive rinse can be more effectively to remove detergent.
- Press START/PAUSE button to indicate remaining time.























Child lock function

















- Use to prevent an accident by children operating the machine.
- Press 'rinse' button for 3 seconds to select or deselect. *(refer to page 27)*

Course button

















- To select laundry course.
- Select course by type of clothes and level of dirtiness.

Washing Course











Washing Course	 POWER	Add the laundry	  Course	Add the Detergent
<p>Normal</p> <p>Used for normal loads, this mode automatically selects the most appropriate conditions and completes the sequence in one operation. The built-in sensor detects the size of the load and the ideal wash power and wash, rinse and spin times are set accordingly.</p>				 <ul style="list-style-type: none"> Water will be supplied. After supplying, laundering will be started.
<p>Smart Rinse</p> <p>Use this Course to increase rinsing performance. This would include underwear and baby clothes. If someone has sensitive skin or skin trouble, use this Course.</p>			 <ul style="list-style-type: none"> Select the Smart Rinse Course on the Control panel. 	 <ul style="list-style-type: none"> Add designated amount of detergent by Water Level and close the door. Use exclusive neutral detergent or dry detergent for home.
<p>Eco Wash</p> <p>Eco course consumes less water and electricity to wash normal clothes.</p>			 <ul style="list-style-type: none"> Select the Eco Wash Course on the Control panel. 	 <ul style="list-style-type: none"> Add the appropriate quantity of Detergent as indicated by the Water Level. Or follow the Detergent manufacturer's instructions
<p>Quick Wash</p> <p>Use this mode when washing lightly soiled clothes for a short time. The highly recommended laundry amount is under 3.0kg.</p>			 <ul style="list-style-type: none"> Select the Quick Wash Course on the Control panel. 	 <ul style="list-style-type: none"> Add the appropriate quantity of Detergent as indicated by the Water Level. Or follow the Detergent manufacturer's instructions
<p>Delicates</p> <p>Use this Course for washing delicate fabrics such as lingerie and woolens. (wash only "water washable" clothes) Before washing your woolens check the care label for the washing instructions. (wash only water washable clothes)</p>			 <ul style="list-style-type: none"> Select the Delicates Course on the Control panel. 	 <ul style="list-style-type: none"> Use neutral Detergent appropriate for the laundry. When washing woolens use a mild Detergent recommended for washing wool.

Close the lid	 START/PAUSE	Finish	Caution & Note
 <ul style="list-style-type: none"> Water will be supplied. After supplying, laundering will be started. 	 <ul style="list-style-type: none"> Tub will rotate more than once without water (While Water Level LED blinking) to recognize Water Level. Then the Water Level and the amount of Detergent to be used will be shown and water will be supplied. 	 <ul style="list-style-type: none"> When the wash Course ends, the buzzer will ring for 10 seconds before the Power goes off automatically. 	<ul style="list-style-type: none"> If water is already in the tub, or putting wet laundry into the tub before starting will increase the Water Level. With lightweight bulky loads, Water Level can be set low.
			<ul style="list-style-type: none"> Water supply and drain is executed during rinse and this is a part of normal operation.
			
			
			<ul style="list-style-type: none"> Lay out in cool floor or on a hanger covered by a towel to dry these type of clothes. It might have damp clothes because spin dry intensity and time are set too short to prevent damage of clothes. (Spin dry cannot be changed)







Washing Course

Washing Course	 POWER	Add the laundry	  Course	Add the Detergent
<p>School Care</p> <p>Use this Course to wash School Uniform.</p>			<p></p> <ul style="list-style-type: none"> Select the School Care Course on the Control panel. 	<p></p> <ul style="list-style-type: none"> Add the appropriate quantity of Detergent As indicated by the Water Level. Or follow the Detergent Manufacturer's instructions.
<p>Duvet</p> <p>Use for blanket or bedclothes with  sign.</p>			<p></p> <ul style="list-style-type: none"> Select the Duvet Course on the Control panel. 	<p></p> <ul style="list-style-type: none"> Pour detergent after dissolve at warm water. If detergent is pour into cold water, it might cause leftover detergent in bedclothes.
<p>Pre Wash+Normal</p> <p>Washing laundry with Pre Wash+Normal cycle that pretreats immediate stain without hand-wash.</p>			<p></p> <ul style="list-style-type: none"> Select the Pre Wash+Normal Course on the Control panel 	<p></p> <ul style="list-style-type: none"> Add the appropriate quantity of Detergent as indicated by the Water Level. Or follow the Detergent manufacturer's instructions



Close the lid	 START/PAUSE	Finish	Caution & Note
			
			<ul style="list-style-type: none">• Cashmere bedclothes, acrylic blanket, mixed spinning blanket, woolen blanket, infilling (polyester 100), and bed sheet might be damaged by floating. Please purchase a separate laundry net to wash.• Separate bed clothes to general clothes. It might cause laundry to askew and results in abnormal washing.• Spin dry might take longer to spread out laundry if bedclothes are lumped to a side.• Never laundry an electric blanket or a carpet. It cause damage to a laundry machine and the laundry.• Please use laundry net to soak and sink bedclothes that are easy to be inflated. It might cause damage on laundry and machine parts if inflated.
			<ul style="list-style-type: none">• Washing laundry with Pre Wash+ Normal cycle that pretreats immediate stain without hand-wash. i.e. Necessary for clothes which could be smelled badly without prompt laundry.

Favorite Wash

<p>1</p>  <p>POWER</p>	<p>Press the POWER button to turn power on.</p>
<p>2</p>   <p>Course</p>	<p>Put laundry in and Press the Course button to Select Favorite Course.</p> <ul style="list-style-type: none">• Press Water Wave button and select Water Wave. ("Medium Wave" if nothing is selected)• Select Water Level by pressing Water Level button.• Select laundry time, number of rinse, and Spin intensity desire to save by pressing each of laundry, rinse and Spin button.
<p>3</p>  <p>START/PAUSE</p>	<p>Press the START/PAUSE button.</p>
<p>4</p> 	<p>Add designated amount of detergent by Water Level and close the door.</p> <ul style="list-style-type: none">• Please use appropriate exclusive neutral detergent or dry detergent for home when "Delicate" course is selected for Favorite Course.
	<p>When the wash Course ends, the buzzer will ring for 10 seconds before the Power goes off automatically.</p>













To save Favorite Course.

1. Select laundry options and operate as above.
2. It is saved as the operation starts.
3. It is saved even if laundry is paused or power is turned off.











To recall your Favorite cycle.

1. Press POWER on.
2. Select the Favorite cycle by pressing the Course.
3. Press the START/PAUSE button. Then the wash cycle starts.

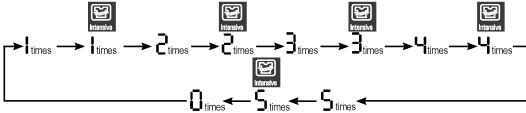
Soak Wash

<p>1</p>  <p>POWER</p>	<p>Press the POWER button to turn power on.</p>
<p>2</p>   <p>Course</p>	<p>Put laundry in and Press the Course button to Select Washing Course.</p> <ul style="list-style-type: none">• Whitening, Allergy Care, Delicate, Quick Wash, Tub Clean Course do not suppose soak laundry.
<p>3</p>  <p>Soak</p>	<p>Press soak laundry button.</p> <ul style="list-style-type: none">• “Soak laundry” can be selected by pressing button and indicated by light on soak indicator()• Soak selection : 15 ▶ 30 ▶ 45 ▶ 1:00 ▶ 2:00 ▶ 3:00 ▶ off ▶ 15
<p>4</p>  <p>Rinse² * Child Lock</p>  <p>Spin * Air Dry</p>	<p>Press each of rinse and Spin button to select number of Rinse and Spin.</p>
<p>5</p> 	<p>Add designated amount of detergent by Water Level and close the door.</p>
<p>6</p>  <p>START/PAUSE</p>	<p>Press the START/PAUSE button.</p> <ul style="list-style-type: none">• Water will be supplied. After supplying, laundry will be started.
	<p>When the wash Course ends, the buzzer will ring for 10 seconds before the Power goes off automatically.</p>

Intensive Rinse





<p>1</p>  <p>POWER</p>	<p>Press the POWER button to turn power on.</p>
<p>2</p>   <p>Course</p>	<p>Put laundry in and Press the Course button to Select Washing Course.</p> <ul style="list-style-type: none"> Intensive Rinse can be selected only under Normal, Smart Rinse, School Care, and Favorite.
<p>3</p>  <p>Rinse</p>	<p>Press Rinse button to start Intensive Rinse ().</p> 
<p>4</p>    <p>Wash Rinse Spin</p>	<p>Press each of Wash button and Spin button to set duration.</p>
<p>5</p> 	<p>Add designated amount of detergent by Water Level.</p>
<p>6</p>  <p>START/PAUSE</p>	<p>Press the START/PAUSE button.</p>
	<p>When the wash Course ends, the buzzer will ring for 10 seconds before the Power goes off automatically.</p>

NOTE

- Use Intensive Rinse to remove detergents more effectively.
- Intensive Rinse might work if Water Level changed during operation.

Tub Clean

If scud is allowed to build-up in the machine it can result in stains on your clothes or unpleasant smell in your washer. Scud is the way build-up that can occur within any washer when the fabric softener comes into contact with Detergent, and according to particular degree of dirtiness or quality of water to be use, in these case, use this Course to clean inner tub and outer tub.

1  POWER	Press the POWER button to turn power on.
2  Course	Press the Course button to Select Tub Clean Course.
3  START/PAUSE	Press the START/PAUSE button. <ul style="list-style-type: none">• Time will be displayed on screen.
4 	Put in exclusive detergent for laundry tub or oxide bleaching agent in the bleaching agent dispenser and close the door.
	When the wash Course ends, the buzzer will ring for 10 seconds before the Power goes off automatically.

Recommended cleaner :



- (1) Powder bleaching agent :
Purchase a product at a market and refer to usage instruction at the back of the product.
- (2) Liquid bleaching agent:
Dilute to 300 times of water capacity of washing machine.





Do not put laundry for laundry tub course.

- Use oxide bleaching agent (300g). (do not use chlorine bleaching agent.)
- Clean laundry tub per month using laundry tub course.
- Please clean laundry tub if there are fuzz.
- It is convenient to use laundry tub course at night or during an outing

Automatic detection of time to clean Tub

- After Power On button pressing, if **E C L** is blinking in the display, it is the time for Tub Cleaning.
- If you want to skip the Tub Clean, press option buttons to select desired cycle.
- After performing tub clean, **E C L** will disappear until next cleaning time.
- Tub Clean time is detected automatically as per the usages of washer (Generally once after 30 usages)

Air Dry

<p>1</p>  <p>POWER</p>	<p>Press the POWER button to turn power on.</p>
<p>2</p>  <p>Spin * Air Dry</p>	<p>Press Spin for 3 seconds to select Air Dry.</p> <ul style="list-style-type: none">• Other function cannot be selected during Air Dry.• Automatically set to 60 minutes upon selection.• Press Spin button again to select duration (90min ▶ 120 min ▶ 60 min.)• To deselect Air Dry press power button.
<p>3</p>  <p>START/PAUSE</p>	<p>Press the START/PAUSE button.</p>
	<p>When the wash Course ends, the buzzer will ring for 10 seconds before the Power goes off automatically.</p>



When you select Air Dry for more than 60 minutes







- 1) You can reduce the drying time by minimizing the moisture in the laundry.
- 2) Always keep the laundry amount to 2kg or less and make sure to spread it out evenly.
- 3) Select 60 minutes for cotton laundry and 120 minutes for synthetic fiber laundry for effective Moisture removal.

Option Washing

When you only need the Wash, Wash/Rinse or Rinse cycles, these can be set manually.

- 1** Press the **POWER** button to turn power on.



2	Only Wash Press the Wash button to select the desired timing.  Wash _{time}	Only Rinse Press the Rinse button to select the desired times of rinse.  Rinse _{time}	Only Spin Press the Spin button to select the desired times of spin.  Spin
	Only Wash,Rinse Press the Wash button to select the desired timing.  Wash _{time} Press the Rinse button to select the desired times of rinse.  Rinse _{time} You can use this option for preventing wrinkles of laundry	Only Rinse,Spin Press the Rinse button to select the desired times of rinse.  Rinse _{time} Press the Spin button to select the desired times of spin.  Spin	Only Drain When you want to only drain, wait until the water in the washing tub drains completely.

- 3** Press the **Water Level** button, to control the water level according to the amount of laundry. If you do not choose anything, it is set the middle water level automatically.



- 4** Add the laundry into the washing tub.

- 5** Press the **START/PAUSE** button.











- 6** Add the detergent and close the lid.

NOTE

- When a **Wash, Wash/Rinse or Rinse only option** is selected, after the wash is completed the water will not be drained off. If you wish to drain the water, press Spin button and wait until the water in the tub has drained completely. Then press the **START/PAUSE** button.
- If you do not specify the **water level**, then Medium will be automatically selected.
- If only Rinse is selected, the process will start from Water Supply.

Time Delay (RESERVATION) Wash

<p>1</p>  <p>POWER</p>	<p>Press the POWER button to turn power on.</p>
<p>2</p>   <p>Course</p>	<p>Put laundry and detergent in and Press the Course button to Select Washing Course.</p> <ul style="list-style-type: none">• Put synthetic powder detergent in a slot for reservation• This Course will not work in Delicate and Tub Clean Course.
<p>3</p>  <p>Time Delay</p>	<p>Press Time Delay (RESERVATION) button to set reservation time.</p> <ul style="list-style-type: none">• If reservation button is pressed, it will turn on reservation lamp and show up 3:00. <div data-bbox="325 671 964 874" style="border: 1px solid gray; padding: 10px;"><p>ex) It is 1:00 PM and if you want to finish laundry by 7:00 PM</p><ul style="list-style-type: none">• Keep press reservation button to set desired laundry ending time. (7:00-1:00=6hours)<div data-bbox="408 794 899 858" style="text-align: center;"> → </div><ul style="list-style-type: none">• Reservation can be made up to 3~18 hours by 1 hour interval up to 3~12hours and 2 hour interval for 12~18 hours.• Less than 3 hour cannot be reserved.</div>
<p>4</p>  <p>START/PAUSE</p>	<p>Close the door and press START/PAUSE button.</p> <ul style="list-style-type: none">• Reservation lamp will blink and remaining time will be displayed
	<p>Laundry will be done at reserved time.</p> <ul style="list-style-type: none">• Ending time might be slightly different by water pressure



- If door is opened during reservation. Press “START/PAUSE” button to reschedule reservation. Then close the door and press “START/PAUSE” button.



- To cancel reservation, press Time Delay (Reservation) button repeatedly until the reservation is canceled or press power button to turn off and on power.

Other Useful Functions

Child Lock Function

If you want to lock all the keys to prevent settings from being changed by a child, you can use the child lock option.

How to Lock

1 Press the **POWER** button.



- Turn Power on.

2 Press the **START/PAUSE** button to start washing.



- After all washing conditions are set according to the manual.

3 Press the **Rinse** button for 3 seconds to select Child Lock.



- The button lock is set, it will not be released automatically if the cycle is terminated.
- Thus, you should turn power on washing machine and then terminate the function by pushing "Rinse" button.

How to Unlock

If you want to unlock during wash, press the **Rinse** button for 3 seconds again.

NOTE

- "CL" & the remaining time are alternatively shown on the display while they are locked.

Seeing Remaining Time

To see the remaining time for each process, press one of the **Wash**, **Rinse** and **Spin** buttons. The remaining time for each process will appear for about 1 second.

Placing and Leveling

Please ensure that transit restraint has been removed before operating your machine.

1 Place the machine on a flat and firm surface which allows proper clearance.

We suggest a minimum clearance of 2 cm to the right side and left sides of the machine for ease of installation.

At the rear, a minimum clearance of 10 cm is suggested.

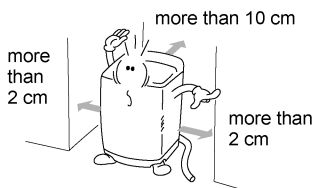

NOTE

If the washer is installed on a uneven, weak or tilted floor causing excessive vibration, spin failure or “UE” error can happen to it.

It must be placed on a firm and level floor to prevent spin failure.

2 Make sure that the washer is properly Level

Open the lid and look from above to see if it is same as shown.

Top view of the machine

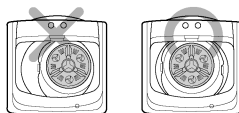

3 Leveling the machine

Lift the front of the washing machine and twist the Adjustable Leg until the machine is placed evenly.

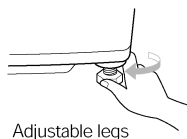

* Installing the Anti-Rat Cover(option) : Insert the anti rat cover to be firmly fixed from the back or the front of the washing machine and then secure it by using the setting screw.

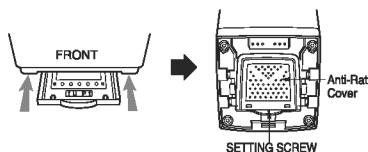

Caution

If the power is supplied from a extension cord set or generator, the extension cord set or electrical portable outlet device should be positioned so that it is not exposed to splashing or ingress of moisture.

Connecting Water Supply Hose

Before connecting the Water Supply Hose to the water tap, check the hose type and then choose the correct instruction here under.

Note that the Water Supply Hose supplied may vary from country to country. Make sure to connect the blue inlet hose to the COLD water tap, and the orange inlet hose to the HOT water tap.

Connecting Water Supply Hose to water tap

Normal Type

(Normal tap without thread & screw type inlet hose.)

1

Untighten the screw

Untighten the screw of the connector so that the tap can be placed in the middle.

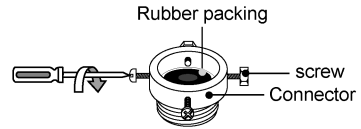

2

Fixing the connector to the tap

Push the upper connector up till the rubber packing is in tight contact with the tap. Then tighten the 4 screws.

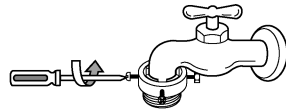

3

Attach the water supply hose securely to the connector

Push the water supply hose vertically upwards so that the rubber seal within the hose can adhere completely to the tap.

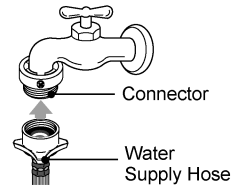

4

Fixing the connector to the water supply hose

Attach the water supply hose to the connector and then tighten it by screwing it to the right.

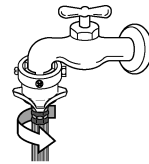

5

Check the connection of water supply hose and the connector

After connecting the hose, open the tap to check for any water leakage. If the water leaks, close the tap and start again from step 1

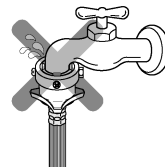

NOTE

The washing machine is to be connected to the water mains using new hose-sets and old hose-sets should not be reused.

Connecting Water Supply Hose

Normal Type (Normal tap without thread & one touch type inlet hose.)

1 Separate Middle connector from Water Supply Hose

Separate Middle connector from the Water Supply Hose by pulling the Pressing Rod and the Pressing Handle that is attached to the Water Supply Hose.

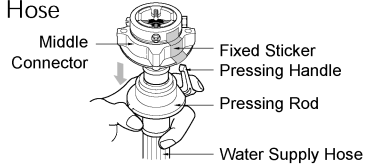

2 Loosen the fixed nuts to connect the connector to the tap

Untighten the screw of the connector so that the tap can be placed in the middle.

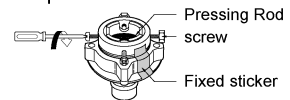

NOTE

In case tap is too large. If the tap diameter is too large or is square, untighten the 4 screws and remove the guide plate. Then follow step 1.

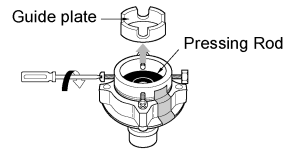

3 Fixing Connectors to the Tap

Push the upper connector up till the rubber packing is in tight contact with the tap. Then tighten the 4 screws.

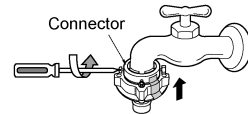

4 Fixing Upper Connector and Middle Connector

Remove the fixed sticker in between the Upper and Middle Connectors. Tighten the connectors by holding one connector and twist middle connector to the right.

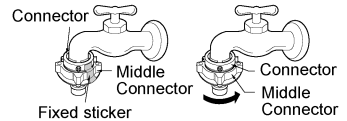

5 Connecting Middle Connector and Water Supply Hose

Press down the pressing rod of the Water Supply Hose which was separated from middle connector (refer to Step1) and then join it to the middle connector.

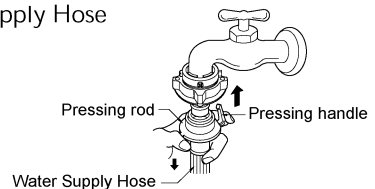

6 Check for water leakage

After connecting the hose, open the tap to check for any water leakage.

If the connection leaks, close the tap and start again from step 1.

If you skip step 1, water leakage may occur.



Screw Type

1 Attach the water supply hose to the tap.

Push the water supply hose up so that the rubber packing within the hose can adhere completely to the tap.

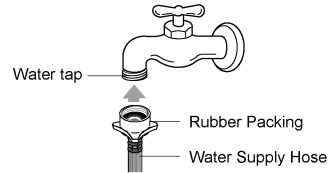

2 Connect the water supply hose to the tap.

Connect the water supply hose to the tap and then tighten it by screwing it to the right.

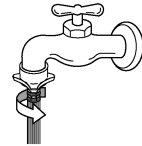

3 Check water leakage.

After connecting the hose, open the tap to check for any water leakage.

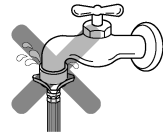

Connecting Water Supply Hose to the machine

- Check to see if there is a rubber seal inside the connector.

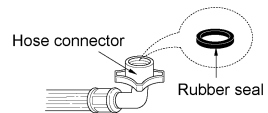

- Connect the water supply hose to inlet valve of the washing machine, and then lock it by turning the hose connecting part.

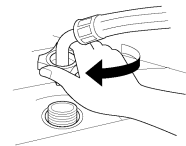

Connecting Drain Hose

Before connecting Drain Hose, check your Drain Hose model and choose the correct instructions.

Pump Model

- 1 Fit the end of the drain hose to the outlet of the drain pump and tighten the clamp.

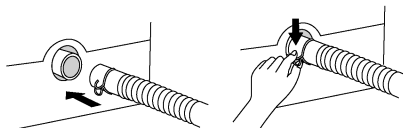

- 2 Put the other end of the drain hose over the standpipe or wash tub.

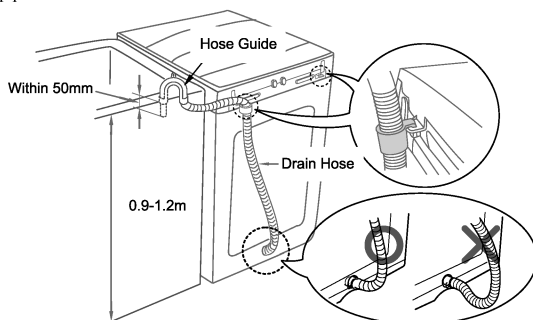

NOTE

- To prevent siphoning, the drain hose should not extend more than 50 mm from the end of the hose guide.
- The discharge height should be approximately 0.9 ~ 1.2 m from the floor.
- The hanging down drain hose might cause poor drainage.

Non-Pump Model

- 1 Before connecting
Ensure that the hose clip is set as indicated here.

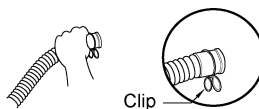

- 2 Connect the Elbow Hose
Push the elbow hose toward the body of the washing machine.

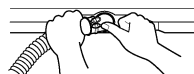

- 3 Place the Drain Hose
To change the direction of the hose, pull out the elbow hose and change the direction.
Repeat Step 2.

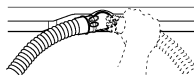

Grounding Method

Earth wire should be connected.

If the earth wire is not connected, there is possible a danger of electric shock caused by the current leakage .

Grounding Method with Ground insert space Terminal

If the AC current outlet has a ground terminal, then separate grounding is not required. Note that AC power outlet configurations may differ from country to country

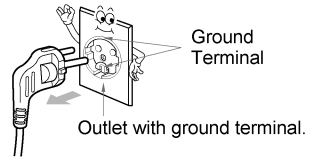

Caution

CAUTION concerning the Power Cord

Most appliances recommend they be placed upon a dedicated circuit; that is, a single outlet circuit which powers only that appliance and has no additional outlets or branch circuits. Check the specification page of this owner's manual to be certain. Do not overload wall outlets. Overloaded wall outlets, loose or damaged wall outlets, extension cords, frayed power cords, or damaged or cracked wire insulation are dangerous. Any of these conditions could result in electric shock or fire. Periodically examine the cord of your appliance, and if its appearance indicates damage or deterioration, unplug it, discontinue use of the appliance, and have the cord replaced with an exact replacement part by an authorized servicer. Protect the power cord from physical or mechanical abuse, such as being twisted, kinked, pinched, closed in a door, or walked upon. Pay particular attention to plugs, wall outlets, and the point where the cord exits the appliance.

Other Grounding Method

Burying Copper Plate

Connect the Ground Wire to a Ground Copper Plate and bury it more than 75cm in the ground.

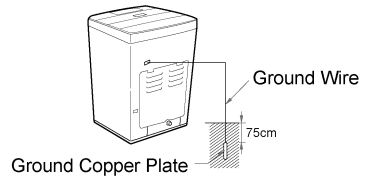

Using Ground Wire

Connect the ground Wire to the socket provided exclusively for Grounding.

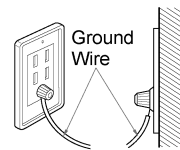

Using a Short Circuit Breaker

If grounding methods described above are not possible, a separate circuit breaker should be employed and installed by a qualified electrician

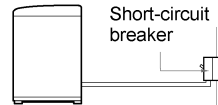

Caution

- To prevent a possible explosion, do not connect ground to a gas pipe
- Do not connect ground to telephone wires or lightning rods. This may be dangerous during electrical storms
- Connecting ground to plastic has no effect
- Ground wires should be connected when an extension cord is used.

Cleaning and Maintenance

Cold water washing

- If you always use COLD water, we recommend that a WARM or HOT wash be used at a regular intervals e.g. every 5th wash should be at least a WARM one.

When you have finished

- Turn off taps to prevent the chance of flooding should a hose burst.
- Always unplug the power cord after use.

When water supply into the tub is not clean or the filter is clogged with particles (such as sand), clean the filter in the inlet valve occasionally.

(The figure of power cord and water tap may vary according to the country)

To Clean the Filter in the Inlet Valve

- 1** Close the tap. Select HOT/COLD(WARM) and then press the [START/PAUSE] button to remove water from the machine completely.



- 2** Turn off the power before pulling out the cord.



- 3** After removing the water supply hose pull out the filter. Then use a brush to clean the filter.

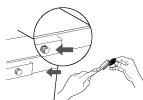

- 4** Replace the filter after cleaning it.

NOTE

- Before cleaning the filter, the impurities in the water supply hose should be removed.

To Clean the Pump casing (for pump model)

- 1** Place a towel on the floor under the drain pump cap. Excess water may flow out.

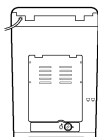

- 2** Turn the cap counter-clockwise and pull it out.

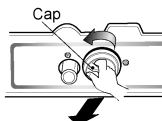

- 3** Remove any foreign objects and fluff inside pump casing and from the filter.

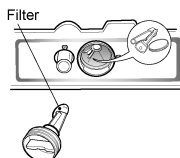

- 4** Replace the cap. Insert the filter along the guide ribs inside the pump casing. Filter must face the guide ribs inside pump casing and securely turn the cap clockwise.

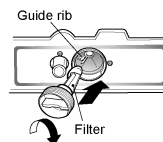

NOTE

- Check if water leaks after reassembling. (The Rubber ring is in the cap)

Cleaning and Maintenance

When there is a fear of freezing

- Close the water taps and remove the Water Supply Hose.
- Remove the water which remains in the water supply.
- Lower the drain hose and drain the water in the bowl and the drain hose by spinning.

If frozen

- Remove the water supply hose, and immerse it in HOT water at approx. 40°C.
- Pour approx. 2 liters of HOT water at approx. 40°C, into the bowl and let it stand for 10 minutes.
- Connect the water supply hose to the water tap and confirm that the washing machine performs the supply and drainage of water.

Wash Inner-tub Leave the lid open after washing to allow moisture to evaporate. If you want to clean the inner-tub, use a clean soft cloth dampened with liquid Detergent, then rinse. (Do not use harsh or gritty cleaners.)

Inlet Hoses Hoses connecting washer to faucet should be replaced every 5 years.
Exterior Immediately wipe off any spills. Wipe with damp cloth. Try not to hit surface with sharp objects.

Long Vacations Be sure water supply is shut off at faucets. Drain all water from hoses if weather will be below freezing.

Cleaning the Inside of your Washer

If you use fabric softener or do regular COLD water washing, it is very important that you occasionally clean the inside of your washer.

- Fill your washer with HOT water.
- Add about two cups of a powdered Detergent that contains phosphate.
- Let it operate for several minutes.
- Stop the washer, open the lid and leave it to soak overnight.
- After soaking, drain the washer and run it through a normal cycle.

Or use TUB CLEAN COURSE periodically.

We do not recommend that you wash clothes during this procedure.

Products that might damage your washing machine

- Concentrated bleaches and diaper sanitizer will cause damage to the paintwork and components of your washer.
- Hydrocarbon solvents i.e. petrol, paint thinners and lacquer thinners, etc. can dissolve plastic and blister paint (Be careful when washing garments stained with these solvents as they are flammable DO NOT put them in washer or dryer.)
- Some pretreatment sprays or liquids can damage your washer's control panel.
- Use of dyes in your washer may cause staining of the plastic components. The dye will not damage the machine but we suggest you thoroughly clean your washer afterwards. We do not recommend the use of dye strippers in your washer.
- Do not use your washer lid as a work surface.

Soft Safety Door

- Using tempered glass, inside can be seen while washing and safety is guaranteed.
- To prevent sudden close of door, it uses smart hinge so the door closes softly.
- Door is heavy. Be careful not to be caught in hand or other material.
It might cause injury or damage on product.

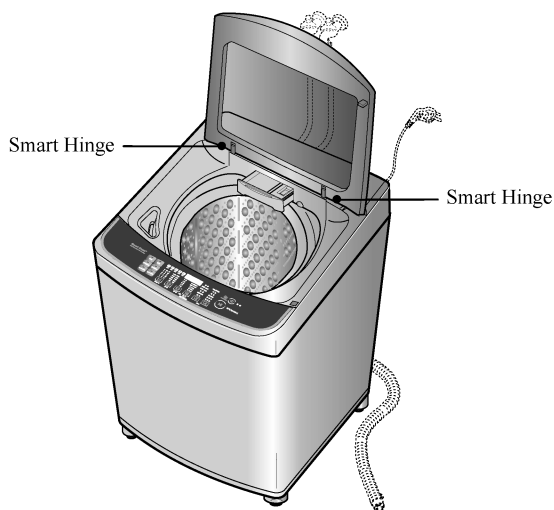

NOTE

- For customer safety, the door will be locked automatically during operation (Light turn on "door lock")sign.
If there are additional laundry to put in, press START/PAUSE to unlock.
- Press START/PAUSE Button again to resume operation.

Common washing problems





Many washing problems involve poor soil & stain removal, residues of lint and scum, and fabric damage. For satisfactory washing results, follow these instructions.

WASH PROBLEM

Problems	Possible Causes	Solutions & Preventive Measures
Poor soil removal	<ul style="list-style-type: none"> • Not enough Detergent • Wash Water Temperature too low. • Overloading the washer • Incorrect wash cycle • Incorrect sorting • Didn't pretreat stain 	<ul style="list-style-type: none"> • Use correct amount of Detergent for load size, amount of soil and water Hardness. • Different Water Temperature may be required according to soil type. • Reduce load size. • Wash with PRE WASH+NORMAL or DUVET or SOAK & DUVET wash cycle for heavy soiled laundry. • Separate heavily soiled items from lightly soiled ones. • Pretreat stain and heavy soil according to directions shown on page 9.
Blue Stains	<ul style="list-style-type: none"> • Undiluted fabric softener dispensed directly onto fabric 	<ul style="list-style-type: none"> • Rub the stain with bar soap. Wash. • Do not overfill fabric softener dispenser and do not pour liquid fabric softener directly onto fabric. <p>See page 12 for more instructions.</p>
Black or gray marks on clothes	<ul style="list-style-type: none"> • A buildup caused by the interaction of fabric softener and Detergent can flake off and mark clothes • Not enough Detergent 	<ul style="list-style-type: none"> • Keep the recommendations against Scrud(waxy buildup). (refer to scrud page12.) • Use correct amount of Detergent for load size, amount of soil and water Hardness.
Yellow or brown rust stains	<ul style="list-style-type: none"> • Iron or manganese in water supply, water pipes, or water heater 	<ul style="list-style-type: none"> • To restore discolored load of whites, use rust remover safe for fabric. • Install nonprecipitating water softener or an iron filter in your water supply system for an ongoing problem. • Before washing, run water for a few minutes to clear lines.
Lint	<ul style="list-style-type: none"> • Incorrect sorting • Tissues left in pocket • Overloading the washer 	<ul style="list-style-type: none"> • Wash lint givers eg towels, flannelette sheets, separately from lint collectors eg synthetic fabrics and remove tissues in pockets before wash. See page 9 for sorting and caring before loading. • Do not overload the washer
Residue or Detergent	<ul style="list-style-type: none"> • Overloading the washer • Undissolved Detergent • Use too much Detergent 	<ul style="list-style-type: none"> • Do not overload the washer. • Some Detergents need to be pre-dissolved, check the Detergent instructions. Try pre-dissolving the Detergent. • Increase Water Temperature using HOT water safe for fabric. • Use proper amount of Detergent.
Holes, tears, or snags	<ul style="list-style-type: none"> • Incorrect use of chlorine bleach. • Unfastened zippers, hooks, buckles • Ribs, tears and broken threads • Overloading the washer • Degradation of fabric 	<ul style="list-style-type: none"> • Never pour chlorine bleach directly on fabric. See page 11 for adding liquid bleach. • Fasten zippers, hooks, and buckles. • Remove objects in pockets. See page 9 for caring before loading. • Do not overload the washer.

Troubleshooting

Before calling for service, check the problem against the list belows.

Symptom	Error Message	Check up
Water Supply Failure		<ul style="list-style-type: none"> • Is the water tap shut off? • Is the water supply cut off ? • Is the tap or water supply hose frozen ? • Is the water pressure low or is the filter of the inlet valve clogged with impurities? • Is the Hot hose connected to cold? • Is the Cold hose connected to hot?
Drainage Failure		<ul style="list-style-type: none"> • Is the drain hose positioned correctly? • Is the drain hose bent or placed too high? • Is the internal part of the hose or drain pump (only pump model) clogged with impurities? • Check if electric power has gone off.
Spin Failure		<ul style="list-style-type: none"> • Is the laundry evenly balanced? • Is the washing machine placed on a flat surface?
Door(Lid) Open		<ul style="list-style-type: none"> • Is the lid closed?
Door(Lid) Close		<ul style="list-style-type: none"> • Is the lid closed? • Make sure that the lid is closed properly and press the START/PAUSE button. The washer will not operate unless the lid is locked. • Make sure that nothing is caught under the lid, including shipping material or clothing.
Foreign objects		<ul style="list-style-type: none"> • Are there foreign objects such as coins, pins, etc., caught between the wash plate and the inner basket ? • Turn off the washer and then press the Power button. Press the spin speed button without selecting a cycle to drain and spin the load. When the spin is complete, remove the clothes and then find and remove any objects caught in the wash plate.
The washer experienced a power failure.		<ul style="list-style-type: none"> • Restart the cycle.
Water temperature is too low.		<ul style="list-style-type: none"> • It occurs when there is a failure in the water supply, drainage failure and the water temperature is low. • Check the water supply and drain cycles are normal? • Check the inlet hose, drain hose and the inner tub are freezing? • If the test is positive, ask for help to the nearest LG technical assistance.
Tub Clean Alarm		<ul style="list-style-type: none"> • Please empty the tub, insert bleach into the detergent dispenser and select the Tub Clean cycle. • If you want to skip the Tub Clean, press option buttons to select desired cycle. In this case, you would see the message again after few washing times. Once performed Tub Clean cycle, tcl will disappear until next point of time to clean the tub.
		<ul style="list-style-type: none"> • Please call your nearest LG Electronics service center for help.

SmartDiagnosis™

- 1 Close the washer door, and press the **POWER** button.



- If you manipulated other button or dial before pressing Tub Dry button, turn off the power and start again from the beginning.

- 2 Place the phone to **SmartDiagnosis™** display.



- Make sure that the speaking side of the phone to face SmartDiagnosis™ display



- 3 Long press **Tub Dry** button to activate smart diagnosis.



- Place the phone near the SmartDiagnosis™ display, and long press Tub Dry button until tak tak tak sounds.



Note: Before pressing the "Tub Dry" should turn the power button for reuse if you have made other operations. If under the condition "CL", uninstall it, and reconnect the power.

- 4 Hold the phone while data is transmitted.

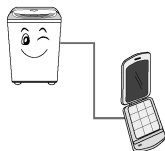

- Keep placing phone to SmartDiagnosis™ display while data for smart diagnosis is being transmitted. The time remaining for data transmission will be displayed on screen.
- Transmission sound may be irritating. For proper diagnosis, do not take off the phone. You can press power button to stop diagnosis function and the sound.

- 5 After the data transmission is completed, listen to the diagnosis result from the consultant.



- When data transmission is completed, the power is automatically turned off with "End" display after a few seconds.

NOTE

Smart Diagnosis is a troubleshooting feature designed to assist, not replace, the traditional method of troubleshooting through service calls. The effectiveness of this feature depends upon various factors, including, but not limited to, the reception of the cellular phone being used for transmission, any external noise that may be present during the transmission, and the acoustics of the room where the machine is located. Accordingly, LG does not guarantee that Smart Diagnosis would accurately troubleshoot any given issue.

Terms of Warranty

What Is Not Covered:

- Service trips to your home to teach you how to use the product.
- If the product is connected to any voltage other than that shown on the rating plate.
- If the fault is caused by accident, neglect, misuse or Act of God.
- If the fault is caused by factors other than normal domestic use or use in accordance with the owner's manual.
- Provide instruction on use of product or change the set-up of the product.
- If the fault is caused by pests for example, rats or cockroaches etc..
- Noise or vibration that is considered normal for example water drain sound, spin sound, or warming beeps.
- Correcting the installation for example, levelling the product, adjustment of drain.
- Normal maintenance which recommended by the owner's manual.
- Removal of foreign objects / substances from the machine, including the pump and inlet hose filter for example, grit, nails, bra wires, buttons etc.
- Replace fuses in or correct house wiring or correct house plumbing.
- Correction of unauthorized repairs.
- Incidental or consequential damage to personal property caused by possible defects with this appliance.
- If this product is used for commercial purpose, it is not warranted.
(Example : Public places such as public bathroom, lodging house, training center, dormitory)

If the product is installed outside the normal service area, any cost of transportation involved in the repair of the product, or the replacement of a defective part, shall be borne by the owner.

Specification

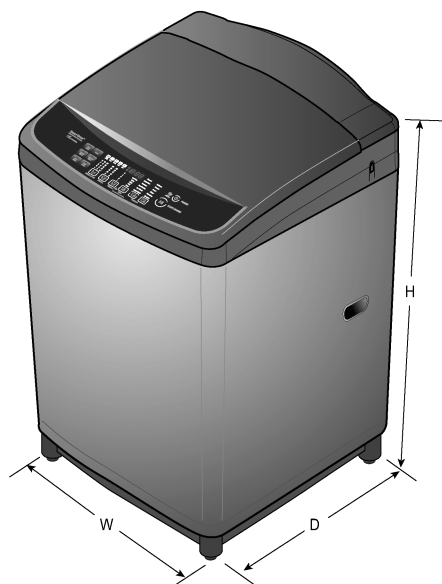

Model	WF-HXB110FS
Wash capacity	11.0 kg
Power supply	240 V~50 Hz
Rated input	600 W
Water tap pressure	30 - 800 kPa (0.3 - 8.0 kgf/cm ²)
Weight	45 kg
Size	590(W) × 606(D) × 990(H) mm

※ In our continuing effort to improve the quality of our appliances, it may be necessary to make changes to the appliance without revising this manual.

