



OWNER'S MANUAL
Safety and Reference

LED TV*

* LG LED TVs are LCD TVs with LED backlighting.

Please read this manual carefully before operating your TV and retain it for future reference.

32LX330C	49LX341C	42LX530S	49LX540S	43LX310C
42LX330C	55LX341C		55LX540S	49LX310C
	60LX341C		60LX540S	
	65LX341C		65LX540S	



www.lg.com

P/NO : MFL68925802 (1504-REV01)

Important Safety Instructions

Always comply with the following precautions to avoid dangerous situations and ensure peak performance of your product.



WARNING/CAUTION
RISK OF ELECTRIC SHOCK
DO NOT OPEN



TO REDUCE THE RISK OF ELECTRIC SHOCK DO NOT REMOVE COVER (OR BACK). NO USER SERVICEABLE PARTS INSIDE. REFER TO QUALIFIED SERVICE PERSONNEL.

 The lightning flash with arrowhead symbol within an equilateral triangle is intended to alert the user to the presence of uninsulated dangerous voltage within the product's enclosure that may be of sufficient magnitude to constitute a risk of electric shock to persons.

 The exclamation point within an equilateral triangle is intended to alert the user to the presence of important operating and maintenance (servicing) instructions in the literature accompanying the appliance.

WARNING/CAUTION

- TO REDUCE THE RISK OF FIRE AND ELECTRIC SHOCK, DO NOT EXPOSE THIS PRODUCT TO RAIN OR MOISTURE.

WARNING

If you ignore the warning message, you may be seriously injured or there is a possibility of accident or death.

CAUTION

If you ignore the caution message, you may be slightly injured or the product may be damaged.

NOTE

The note helps you understand and use the product safely. Please read the note carefully before using the product.

WARNING: This product contains chemicals known to the State of California to cause cancer and birth defects or other reproductive harm. ***Wash hands after handling.***

Read these instructions.
Keep these instructions.
Heed all warnings.
Follow all instructions.



- Do not use this apparatus near water.



- Clean only with dry cloth.



- Do not block any ventilation openings. Install in accordance with the manufacturer's instructions.



- Do not install near any heat sources such as radiators, heat registers, stoves, or other apparatus (including amplifiers) that produce heat.



- Do not defeat the safety purpose of the polarized or grounding-type plug. A polarized plug has two blades with one wider than the other. A grounding type plug has two blades and a third grounding prong. The wide blade or the third prong are provided for your safety. If the provided plug does not fit into your outlet, consult an electrician for replacement of the obsolete outlet.



- Protect the power cord from being walked on or pinched particularly at plugs, convenience receptacles, and the point where they exit from the apparatus.



- Only use attachments/accessories specified by the manufacturer.



- Use only with the cart, stand, tripod, bracket, or table specified by the manufacturer, or sold with the apparatus. When a cart is used, use caution when moving the cart/apparatus combination to avoid injury from tip-over.



- Unplug this apparatus during lightning storms or when unused for long periods of time.



- Refer all servicing to qualified service personnel. Servicing is required when the apparatus has been damaged in any way, such as power-supply cord or plug is damaged, liquid has been spilled or objects have fallen into the apparatus, the apparatus has been exposed to rain or moisture, does not operate normally, or has been dropped.



- Do not press strongly upon the panel with a hand or a sharp object such as a nail, pencil, or pen, or make a scratch on it.



- Do not stick metal objects or any other conductive material into the power cord. Do not touch the end of the power cord while it is plugged in.
- Keep the packing anti-moisture material or vinyl packing out of the reach of children. Anti-moisture material is harmful if swallowed. If swallowed, induce vomiting and go to the nearest hospital. Additionally, vinyl packing can cause suffocation. Keep it out of the reach of children.
- CAUTION concerning the Power Cord (Can differ by country): Check the specification page of this owner's manual to be certain. Do not connect too many appliances to the same AC power outlet as this could result in fire or electric shock. Do not overload wall outlets. Overloaded wall outlets, loose or damaged wall outlets, extension cords, frayed power cords, or damaged or cracked wire insulation are dangerous. Any of these conditions could result in electric shock or fire. Periodically examine the cord of your appliance, and if its appearance indicates damage or deterioration, unplug it, discontinue use of the

appliance, and have the cord replaced with an exact replacement part by an authorized service. Protect the power cord from physical or mechanical abuse, such as being twisted, kinked, pinched, closed in a door, or walked upon. Pay particular attention to plugs, wall outlets, and the point where the cord exits the appliance. Do not move the TV with the power cord plugged in. Do not use a damaged or loose power cord. Be sure do grasp the plug when unplugging the power cord. Do not pull on the power cord to unplug the TV.



- **Warning** - To reduce the risk of fire or electrical shock, do not expose this product to rain, moisture or other liquids. Do not touch the TV with wet hands. Do not install this product near flammable objects such as gasoline or candles, or expose the TV to direct air conditioning.



- Do not expose to dripping or splashing and do not place objects filled with liquids, such as vases, cups, etc. on or over the apparatus (e.g., on shelves above the unit).



• **Grounding**

(Except for devices which are not grounded.) Ensure that you connect the earth ground wire to prevent possible electric shock (i.e., a TV with a three-prong grounded AC plug must be connected to a three-prong grounded AC outlet). If grounding methods are not possible, have a qualified electrician install a separate circuit breaker. Do not try to ground the unit by connecting it to telephone wires, lightning rods, or gas pipes.

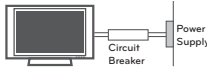

- As long as this unit is connected to the AC wall outlet, it is not disconnected from the AC power source even if the unit is turned off.
- Do not attempt to modify this product in any way without written authorization from LG Electronics. Unauthorized modification could void the user's authority to operate this product.

• **Outdoor Antenna Grounding**

(Can differ by country):

If an outdoor antenna is installed, follow the precautions below. An outdoor antenna system should not be located in the vicinity of overhead power lines or other electric light or power circuits, or where it can come in contact with such power lines or circuits as death or serious injury can occur. Be sure the antenna system is grounded to provide some protection against voltage surges and built-up static charges. Section 810 of the National Electrical Code (NEC) in the U.S.A. provides information with respect to proper grounding of the mast and supporting structure, grounding of the lead-in wire to an antenna discharge unit, size of grounding conductors, location of antenna discharge unit, connection to grounding electrodes and requirements for the grounding electrode.

Antenna grounding according to the National Electrical Code, ANSI/NFPA 70

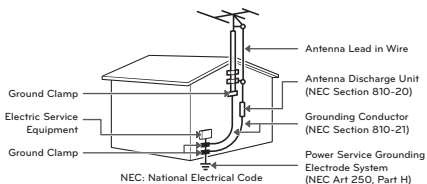

• **Cleaning**

When cleaning, unplug the power cord and wipe gently with a soft cloth to prevent scratching. Do not spray water or other liquids directly on the TV as electric shock may occur. Do not clean with chemicals such as alcohol, thinners, or benzene.

• **Moving**

Make sure the product is turned off, unplugged, and all cables have been removed. It may take 2 or more people to carry larger TVs. Do not press or put stress on the front panel of the TV.

• **Ventilation**

Install your TV where there is proper ventilation. Do not install in a confined space such as a bookcase. Do not cover the product with cloth or other materials while plugged. Do not install in excessively dusty places.

- If you smell smoke or other odors coming from the TV, unplug the power cord and contact an authorized service center.
- Keep the product away from direct sunlight.
- Never touch this apparatus or antenna during a lightning storm.
- When mounting a TV on the wall, make sure not to install the TV by hanging the power and signal cables on the back of the TV.
- Do not allow an impact shock, any objects to fall into the product, and do not drop anything onto the screen.

• **DISCONNECTING THE DEVICE FROM THE MAIN POWER**

The power plug is the disconnecting device. In case of an emergency, the power plug must remain readily accessible.

• **Batteries**

- Store the accessories (battery, etc.) in a safe location out of the reach of children.
- This apparatus uses batteries. In your community there might be regulations that require you to dispose of these batteries properly due to environmental considerations. Please contact your local authorities for disposal or recycling information.
- Do not dispose of batteries in a fire.
- Do not short circuit, disassemble, or allow the batteries to overheat.
- Do not use high voltage electrical equipment near the TV, (e.g., a bug zapper.) This may result in product malfunction.

• **Dot Defect**

The panel is a high technology product with resolution of two million to six million pixels. In a very few cases, you could see fine dots on the screen while you're viewing the TV. Those dots are deactivated pixels and do not affect the performance and reliability of the TV.

• **Generated Sound**

Cracking noise A cracking noise that occurs when watching or turning off the TV is generated by plastic thermal contraction due to temperature and humidity. This noise is common for products where thermal deformation is required.

Electrical circuit humming/panel buzzing

A low level noise is generated from a high-speed switching circuit, which supplies a large

amount of current to operate a product. It varies depending upon the product. This generated sound does not affect the performance and reliability of the product.

- Take care not to touch the ventilation openings. When watching the TV for a long period, the ventilation openings may become hot. This does not affect the performance of the product or cause defects in the product.
- Do not install this product on a wall if it could be exposed to oil or oil mist. This may damage the product and cause it to fall.
- If the TV feels cold to the touch, there may be a small flicker when it is turned on. This is normal; there is nothing wrong with TV. Some minute dot defects may be visible on the screen, appearing as tiny red, green, or blue spots. However, they have no adverse effect on the TV's performance. Avoid touching the LCD screen or holding your finger(s) against it for long periods of time. Doing so may produce some temporary distortion effects on the screen.
- If water or another substance enters the product (like a AC adapter, power cord, TV), disconnect the power cord and contact the service centre immediately. Otherwise, this may result in fire or electric shock.

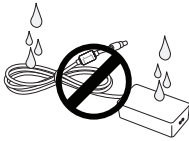

- Only use an authorized AC adapter and power cord approved by LG Electronics. Otherwise, this may result in fire, electric shock, malfunction or product deformation.

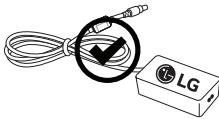

- Never Disassemble the AC adapter or power cord. This may result in fire or electric shock.



Preventing Image Burn or Burn-in on Your TV Screen

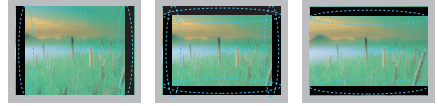

- If a fixed image displays on the TV screen for a long period of time, it will be imprinted and become a permanent disfigurement on the screen. This is image burn or burn-in and not covered by the warranty.
- If the aspect ratio of the TV is set to 4:3 for a long period of time, image burn may occur on the letterboxed area of the screen.
- Avoid displaying a fixed image on the TV screen for a long period of time to prevent image burn.

FCC Notice

(For USA)

This equipment has been tested and found to comply with the limits for a Class B digital device, pursuant to Part 15 of the FCC Rules. These limits are designed to provide reasonable protection against harmful interference in a residential installation. This equipment generates, uses and can radiate radio frequency energy and, if not installed and used in accordance with the instructions, may cause harmful interference to radio communications. However, there is no guarantee that interference will not occur in a particular installation. If this equipment does cause harmful interference to radio or television reception, which can be determined by turning the equipment off and on, the user is encouraged to try to correct the interference by one or more of the following measures:

- Reorient or relocate the receiving antenna.
- Increase the separation between the equipment and the receiver.
- Connect the equipment to an outlet on a circuit different from that to which the receiver is connected.
- Consult the dealer or an experienced radio/TV technician for help.

This device complies with part 15 of the FCC Rules. Operation is subject to the following two conditions: (1) this device may not cause harmful interference and (2) this device must accept any interference received, including interference that may cause undesired operation of the device. Any changes or modifications in construction of this device which are not expressly approved by the party responsible for compliance could void the user's authority to operate the equipment.

FCC Radio Frequency Interference Requirements (for UNII devices)

High power radars are allocated as primary users of the 5.25 to 5.35 GHz and 5.65 to 5.85 GHz bands. These radar stations can cause interference with and/or damage this device. This device cannot be co-located with any other transmitter.

FCC RF Radiation Exposure Statement

[For having wireless function (WLAN, Bluetooth,...)]

This equipment complies with FCC radiation exposure limits set forth for an uncontrolled environment. This transmitter must not be collocated or operating in conjunction with any other antenna or transmitter. This equipment should be installed and operated with minimum distance 20 cm (7.8 inches) between the radiator and your body. Users must follow the specific operating instructions for satisfying RF exposure compliance.

Industry Canada Statement

(For Canada)

[For having wireless function (WLAN, Bluetooth,...)]

This device complies with RSS-210 of the Industry Canada Rules. Operation is subject to the following two conditions:

1. this device may not cause interference and
2. this device must accept any interference, including interference that may cause undesired operation of the device.

IC Radiation Exposure Statement

(For Canada)

[For having wireless function (WLAN, Bluetooth,...)]

This equipment complies with IC radiation exposure limits set forth for an uncontrolled environment. This equipment should be installed and operated with minimum distance 20 cm (7.8 inches) between the radiator & your body.

NOTE : THE MANUFACTURER IS NOT RESPONSIBLE FOR ANY RADIO OR TV INTERFERENCE CAUSED BY UNAUTHORIZED MODIFICATIONS TO THIS EQUIPMENT. SUCH MODIFICATIONS COULD VOID THE USER'S AUTHORITY TO OPERATE THE EQUIPMENT.

⚠ WARNING

(For Canada)

[For product having the wireless function using 5 GHz frequency bands]

- The device for operation in the band 5150–5250 MHz is only for indoor use to reduce the potential for harmful interference to co-channel mobile satellite systems;
- The maximum antenna gain permitted for devices in the bands 5250–5350 MHz and 5470–5725 MHz shall comply with the EIRP limit; and
- The maximum antenna gain permitted for devices in the band 5725–5825 MHz shall comply with the EIRP limits specified for point-to-point and non point-to-point operation as appropriate.
- High-power radars are allocated as primary users (i.e. priority users) of the bands 5250–5350 MHz and 5650–5850 MHz and that these radars could cause interference and/or damage to LE-LAN devices.

Note to Cable/TV Installer

(For USA and Canada)

This reminder is provided to call the CATV system installer's attention to Article 820-40 of the National Electric Code (U.S.A.). The code provides guidelines for proper grounding and, in particular, specifies that the cable ground shall be connected to the grounding system of the building, as close to the point of the cable entry as practical.

LG Recycling Policy

(For USA)

LG Electronics offers a customized e-waste takeback and recycling service that meets local needs and requirements in the countries where e-waste regulations are in place, and also provides product and packaging take-back and recycling service voluntarily in some countries. LG Electronics evaluates products' recyclability at the design step using LG's recyclability evaluation tool, with the goal of improving recyclability where practicable.

Through these activities, LG seeks to contribute to conserving natural resources and protecting the environment.

For more information about the LG Recycling Policy, please visit our global site at <http://www.lg.com/global/sustainability/environment/take-back-recycling>

Preparing

! NOTE

- Image shown may differ from your TV.
- Your TV's OSD (On Screen Display) may differ slightly from that shown in this manual.
- The available menus and options may differ from the input source or product model that you are using.
- New features may be added to this TV in the future.
- The items supplied with your product may vary depending upon the model.
- Product specifications or contents of this manual may be changed without prior notice due to upgrade of product functions.
- For an optimal connection, HDMI cables and USB devices should have bezels less than 10 mm (0.39 inches) thick and 18 mm (0.7 inches) width.
- Use an extension cable that supports USB 2.0 if the USB cable or USB flash drive does not fit into your TV's USB port.
- Use a certified cable with the HDMI logo attached. If you do not use a certified HDMI cable, the screen may not display or a connection error may occur.
- Recommended HDMI cable types (3 m or less)
 - High-Speed HDMI[®]/™ cable
 - High-Speed HDMI[®]/™ cable with Ethernet

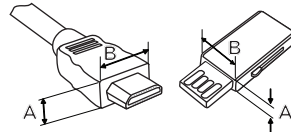

*A ≤ 10 mm (0.39 inches)

*B ≤ 18 mm (0.7 inches)

⚠ CAUTION

- Do not use any unapproved items to ensure the safety and lifespan of the product.
- Any damages or injuries by using unapproved items are not covered by the warranty.
- Some models appear to have a thin film on the screen. It is actually part of the screen; do not remove it.
- When attaching the stand to the TV set, place the screen facing down on a cushioned table or flat surface to protect the screen from scratches.
- Make sure that the screws are fastened tightly. (If they are not fastened securely enough, the TV may tilt forward after being installed.)
- Do not fasten the screws with excessive force; otherwise, they may be worn out and become loose.

Warning when using USB storage devices

- USB storage devices with a built-in auto recognition program or its own driver may not work.
- Some USB storage devices may not work or may work improperly.
- Use only those USB storage devices formatted with FAT32 or NTFS File System provided by Windows.
- For external USB HDD, use devices with less than 5V-rated voltages and 500 mA-rated current.
- It is recommended to use USB flash drive with 32 GB or less and USB HDD with 2 TB or less.
- If a USB HDD with power-saving function does not work properly, turn the power off and on. For more information, refer to the user manual of USB HDD.
- Data in the USB storage device can be damaged so back up important files in other devices. Data maintenance is the user's responsibility. The manufacturer is not responsible for data loss.

Maintenance

Cleaning Your TV

Clean your TV regularly to keep it at peak performance and to extend the product's lifespan.

CAUTION

- Before cleaning, turn the power off and disconnect the power cord and all other cables.
- When the TV is left unattended or unused for a long time, disconnect the power cord from the wall outlet to prevent possible damage from lightning or power surges.

Screen, Frame, Cabinet, and Stand

To remove dust or light dirt, wipe the surface with a dry, clean, and soft cloth.

To remove major dirt, wipe the surface with a soft cloth dampened in clean water or a diluted mild detergent. Then wipe immediately with a dry cloth.

CAUTION

- Do not push, rub, or hit the surface with your fingernail or a sharp object, as this may result in scratches on the screen and image distortions.
- Do not use any chemicals, such as waxes, benzene, alcohol, thinners, insecticides, air fresheners, or lubricants, as these may damage the screen's finish and cause discoloration.
- Do not spray liquid onto the surface. If water enters the TV, it may result in fire, electric shock, or malfunction.

Power Cord

Remove the accumulated dust or dirt on the power cord regularly.

Lifting and Moving the TV

When moving or lifting the TV, read the following to prevent the TV from being scratched or damaged and for safe transportation regardless of its type and size.

- It is recommended to move the TV in the box or packing material that the TV originally came in.
- Before moving or lifting the TV, disconnect the power cord and all cables.

- When holding the TV, the screen should face away from you to avoid damage.



- Hold the top and bottom of the TV frame firmly. Make sure not to hold the transparent part, speaker, or speaker grille area.

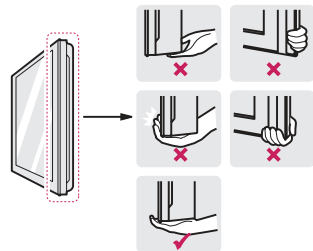

- Use at least two people to move a large TV.
- When transporting the TV by hand, hold the TV as shown in the following illustration.

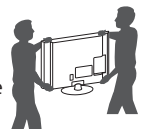

- When transporting the TV, do not expose the TV to jolts or excessive vibration.
- When transporting the TV, keep the TV upright; never turn the TV on its side or tilt towards the left or right.

⚠ CAUTION

- Avoid touching the screen at all times, as this may result in damage to the screen.
- Do not place the product on the floor with its front facing down without padding. Failure to do so may result in damage to the screen.
- Do not move the TV by holding the cable holders, as the cable holders may break, and injuries and damage to the TV may occur. (Depending upon model)

Using the Joystick Button

(Image shown may differ from your TV.)
You can operate the TV by pressing the button or moving the joystick left, right, up, or down.

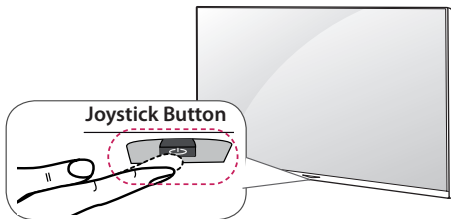

Basic Functions

 Power On	When the TV is turned off, place your finger on the joystick button, press it once, and release it.
 Power Off	When the TV is turned on, place your finger on the joystick button, press it once for a few seconds, and release it. (However, if the menu button is on the screen, pressing and holding the joystick button will let you exit the menu.)
 Volume Control	If you place your finger over the joystick button and move it left or right, you can adjust the volume level.
 Channels Control	If you place your finger over the joystick button and move it up or down, you can scroll through the saved channels.

! NOTE

- Move the joystick up, down, left, or right. Be careful not to press the joystick button. If you press the joystick button first, you may not be able to adjust the volume level and/or scroll through saved channels.

Adjusting the Menu

When the TV is turned on, press the joystick button one time. You can adjust the menu items moving the joystick button up, down, left, or right.

	Turns the power off.
	Accesses the main menu.
	Clears on-screen displays and returns to TV viewing
	Changes the input source.

Mounting on a Table

(Image shown may differ from your TV.)

- 1 Lift and tilt the TV into its upright position on a table.
 - Leave a 10 cm (4 inches) (minimum) space from the wall for proper ventilation.

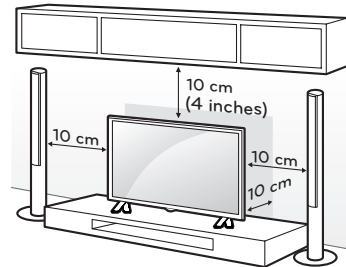

- 2 Connect the power cord to a wall outlet.

⚠ CAUTION

- Do not place the TV near or on sources of heat, as this may result in fire or other damage.

Using the Kensington Security System (optional)

(Depending upon model)

(Image shown may differ from your TV.)

The Kensington security system connector is located at the rear of the TV. For more information of installation and using, refer to the manual provided with the Kensington security system or visit <http://www.kensington.com>. Connect the Kensington security system cable between the TV and a table.

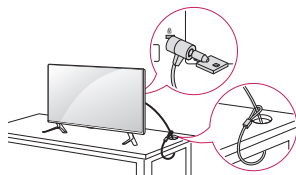

⚠ NOTE

- The Kensington security system is optional. You can obtain additional accessories from your local dealer.

Securing the TV to a Wall (optional)

(Depending upon model)

(Image shown may differ from your TV.)

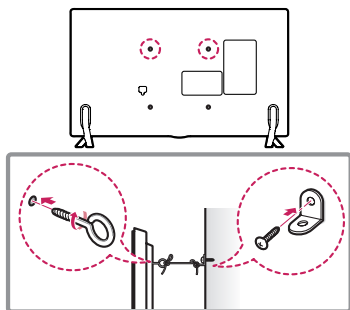

- 1 Insert and tighten the eye-bolts or TV brackets and bolts on the back of the TV.
 - If there are bolts inserted at the eye-bolts position, remove the bolts first.
- 2 Mount the wall brackets with the bolts to the wall. Match the location of the wall bracket and the eye-bolts on the rear of the TV.

- 3 Connect the eye-bolts and wall brackets tightly with a sturdy rope or cable. Make sure to keep the rope parallel to the flat surface.

⚠ CAUTION

- Make sure that children do not climb on or hang on the TV.

⚠ NOTE

- Use a platform or cabinet that is strong and large enough to support the TV securely.
- Brackets, bolts, and ropes are optional. You can obtain additional accessories from your local dealer.

Mounting on a Wall

An optional wall mount can be used with your LG Television. Consult with your local dealer for a wall mount that supports the VESA standard used by your TV model. Carefully attach the wall mount bracket at the rear of the TV. Install the wall mount bracket on a solid wall perpendicular to the floor. If you are attaching the TV to other building materials, please contact qualified personnel to install the wall mount. Detailed instructions will be included with the wall mount. We recommend that you use an LG brand wall mount. When you do not use LG's wall mount bracket, use a wall mount bracket where the device is adequately secured to the wall with enough space to allow connectivity to external devices.

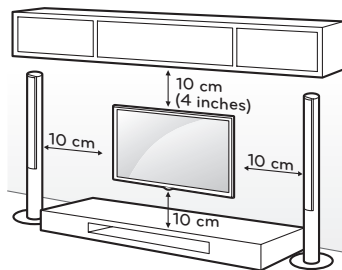

Make sure to use screws and wall mounts that meet the VESA standard. Standard dimensions for the wall mount kits are described in the following table.

Model	32LX330C 43LX310C	42LX330C 42LX530S
VESA (A x B)	200 x 200	400 x 400
Standard screw	M6	M6
Number of screws	4	4
Wall mount bracket (optional)	LSW240B MSW240	LSW440B MSW240
Model	49LX341C 55LX341C 49LX540S 55LX540S 49LX310C	60LX341C 65LX341C 60LX540S 65LX540S
VESA (A x B)	300 x 300	300 x 300
Standard screw	M6	M6
Number of screws	4	4
Wall mount bracket (optional)	LSW350B MSW240	LSW350B

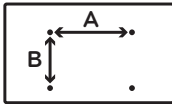

⚠ CAUTION

- Disconnect the power before moving or installing the TV. Otherwise electric shock may occur.
- Remove the stand before installing the TV on a wall mount by performing the stand attachment in reverse.
- If you install the TV on a ceiling or slanted wall, it may fall and result in severe injury. Use an authorized LG wall mount and contact the local dealer or qualified personnel. When using a third-party wall mount, it is not covered by the warranty.
- Do not overtighten the screws as this may cause damage to the TV and void your warranty.
- Use the screws and wall mounts that meet the VESA standard. Any damages or injuries by misuse or using an improper accessory are not covered by the warranty.

! NOTE

- Use the screws that are listed in the VESA standard screw specifications.
- The wall mount kit includes an installation manual and necessary parts.
- The wall mount bracket is optional. You can obtain additional accessories from your local dealer.
- The length of screws may differ depending upon the wall mount. Make sure to use the proper length.
- For more information, refer to the manual supplied with the wall mount.

- When using the wall mounting bracket, apply the adhesive protective label to cover the unused stand opening(s). This will prevent the accumulation of dust and dirt. (Use only when provided with your particular model.)

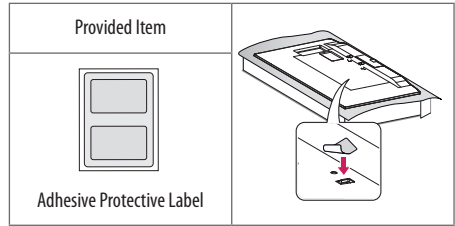

- When attaching a wall mounting bracket to the TV, insert the wall mount inner spacers into the TV wall mount holes to adjust the vertical angle of the TV. (Use only when provided with your particular model.)

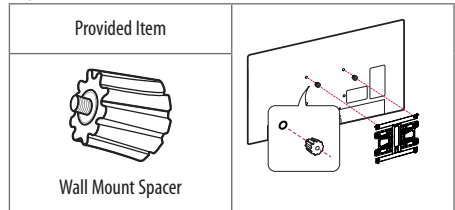

Connections (Notifications)

You can connect various external devices to the TV. Supported external devices are: HD receivers, DVD players, VCRs, audio systems, USB storage devices, PC, gaming devices, and other external devices. For more information on external device's connection, refer to the manual provided with each device.

NOTE

- If you record a TV program on a DVD recorder or VCR, make sure to connect the TV signal input cable to the TV through a DVD recorder or VCR. For more information about recording, refer to the manual provided with the connected device.
- The external device connections shown may differ slightly from illustrations in this manual.
- Connect external devices to the TV regardless about the order of the TV port.
- If you connect a gaming device to the TV, use the cable supplied with the gaming device.
- Refer to the external equipment's manual for operating instructions.

Connecting to an Antenna or Cable

Connect an antenna, cable, or cable box to watch TV while referring to the following. The illustrations may differ from the actual items and an RF cable is optional.

CAUTION

- Make sure not to bend the copper wire of the RF cable.

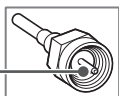

Copper wire

- Complete all connections between devices, and then connect the power cord to the power outlet to prevent damage to your TV.

NOTE

- Use a signal splitter to use 2 TVs or more.
- DTV Audio Supported Codec: MPEG, Dolby Digital.

Other Connections

Connect your TV to external devices. For the best picture and audio quality, connect the external device and the TV with the HDMI cable.

NOTE

- Use only with the 3-pole 3.5 mm Stereo Jack.

Remote Control

The descriptions in this manual are based on the buttons on the remote control. Please read this manual carefully and use the TV correctly. To install batteries, open the battery cover, replace batteries (1.5 V AAA) matching the ⊕ and ⊖ ends to the label inside the compartment, and close the battery cover. Failure to match the correct polarities of the battery may cause the battery to burst or leak, resulting in fire, personal injury, or ambient pollution. To remove the batteries, perform the installation actions in reverse. This remote uses infrared light. When in use, it should be pointed in the direction of the TV's remote sensor.

CAUTION

- Do not mix old and new batteries, as this may damage the remote control.

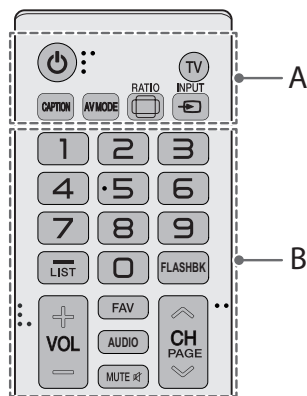

A

POWER Turns the TV on or off.

TV Returns to the last TV channel.

CAPTION Activates or deactivates the subtitles.

AV MODE Selects an AV mode.

RATIO Resizes an image.

INPUT Changes the input source.

B

Number button Enters numbers.

-(DASH) Inserts a dash between numbers such as 2-1 and 2-2.

LIST Accesses the saved channel list.

FLASHBK Alternates between the two last channels selected (pressing repeatedly).

+ VOL - Adjusts the volume level.

FAV Accesses your favorite channel list.

AUDIO Digital signal : Changes the audio language.
Analog signal : Changes the MTS sound.

MUTE Mutes all sounds.

^ CH v Scrolls through the saved channels.

^ PAGE v Moves to the previous or next screen.

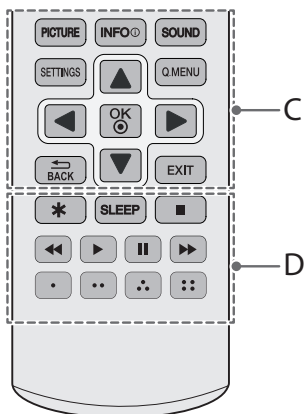

C

PICTURE Changes the image mode.

INFO Shows information on the current program.

SOUND Changes the sound mode.

SETTINGS Accesses the main menu.

Q.MENU Accesses the quick menu.

Navigation button (up/down/left/right) Scrolls through menus or options.

OK Selects menus or options and confirms your input.

BACK Returns to the previous screen.

EXIT Clears all on-screen displays and returns to TV viewing.

D

***** Not functional.

SLEEP Sets the length of time until the TV to turns off.

Control buttons (, , , ,) Controls the MY MEDIA menus and the SIMPLINK compatible devices (USB, SIMPLINK).

Color buttons (, , ,) These access special functions in some menus.

To select Picture Mode

SETTINGS ➔ PICTURE ➔ Picture Mode

Select the picture mode optimized for the viewing environment or the program.

- **Vivid** Heightens contrast, brightness, and sharpness to display vivid images.
- **Standard** Displays images in standard levels of contrast, brightness and sharpness.
- **APS** APS (Auto power saving) mode reduces power consumption by dimming control.
- **Cinema / Game** Displays the optimum picture for movie or game.
- **Expert** Menu for adjusting picture quality that allows experts and amateurs to enjoy the best TV viewing. This menu for adjustment is provided for ISF-certified picture tuning professionals. (ISF logo can be used only on ISF-certified TVs.) ISFccc: Imaging Science Foundation Certified Calibration Control
- Depending upon the input signal, the available range of picture modes may differ.
- **Expert** mode is for picture tuning professionals to control and fine-tune using a specific image. For normal images, the effects may not be drastic.

To Use Energy Saving Feature

SETTINGS ➔ PICTURE ➔ Energy Saving

Reduces power consumption by adjusting peak screen brightness.

- **Off** Turns off the Energy Saving.
- **Minimum / Medium / Maximum** Applies the pre-set Energy Saving.
- **Screen Off** Screen is turned off and only sound is played. Press any button on the remote control to turn the screen back on.

To set Motion Eye Care

[Depending upon model]

SETTINGS ➔ **PICTURE** ➔ **Picture Mode** ➔ **Picture Option**

- **Motion Eye Care** Automatically adjusts brightness and reduces image blur based on image data to reduce eyestrain.

Specifications

Product specifications may be changed without prior notice due to upgrade of product functions.

Television System

ATSC, NTSC-M, 64 & 256 QAM

Program Coverage

VHF 2-13, UHF 14-69, DTV 2-69, CATV 1-135, CADTV 1-135

External Antenna Impedance

75 Ω

Environment Condition

- **Operating Temperature**
0 °C to 40 °C (32 °F to 104 °F)
- **Operating Humidity**
Less than 80 %
- **Storage Temperature**
-20 °C to 60 °C (-4 °F to 140 °F)
- **Storage Humidity**
Less than 85 %

RGB(PC), HDMI (PC) Supported Mode

(Use HDMI IN 1 for PC mode)

Resolution	Horizontal Frequency (kHz)	Vertical Frequency (Hz)
640 x 350	31.46	70.09
720 x 400	31.46	70.08
640 x 480	31.46	59.94
800 x 600	37.87	60.31
1024 x 768	48.36	60.00
1360 x 768	47.71	60.01
1152 x 864	54.34	60.05
1280 x 1024 (For FHD)	63.98	60.02
1920 x 1080 (For FHD)	67.50	60.00
* FHD 42LX330C, 49LX341C, 55LX341C, 60LX341C, 65LX341C, 42LX530S, 49LX540S, 55LX540S, 60LX540S, 65LX540S, 43LX310C, 49LX310C		

HDMI (DTV) Supported Mode

Resolution	Horizontal Frequency (kHz)	Vertical Frequency (Hz)
720 x 480p	31.47	59.94
	31.50	60.00
1280 x 720p	44.96	59.94
	45.00	60.00
1920 x 1080i	33.72	59.94
	33.75	60.00
1920 x 1080p	26.97	23.97
	27.00	24.00
	33.71	29.97
	33.75	30.00
	67.43	59.94
	67.50	60.00

Component Port Connecting Information

Component ports on the TV	Y	P _B	P _R
Video output ports on DVD player	Y	P _B	P _R
	Y	B-Y	R-Y
	Y	Cb	Cr
	Y	Pb	Pr

Component Supported Mode

Resolution	Horizontal Frequency (kHz)	Vertical Frequency (Hz)
720 x 480i	15.73	59.94
	15.73	60.00
720 x 480p	31.47	59.94
	31.50	60.00
1280 x 720p	44.96	59.94
	45.00	60.00
1920 x 1080i	33.72	59.94
	33.75	60.00
1920 x 1080p	26.97	23.976
	27.00	24.00
	33.71	29.97
	33.75	30.00
	67.432	59.94
	67.50	60.00

Supported Video Formats

- Maximum: 1920 x 1080 @ 30p (only Motion JPEG 640 x 480 @ 30p)
- .asf, .wmv
[Video] MPEG-2, MPEG-4 Part2, DivX3.11, DivX4, DivX5, DivX6, XViD, H.264/AVC, VC1 (WMV3, WVC1), MP4
[Audio] WMA Standard, WMA9(Pro), MP3, AAC, AC3, MP3, 3D WMV Single Stream.
- divx, .avi
[Video] MPEG-2, MPEG-4 Part2, DivX3.11, DivX4, DivX5, DivX6, XViD, H.264/AVC
[Audio] HE-AAC, LPCM, ADPCM, MPEG-1 Layer I, MPEG-1 Layer II, Dolby Digital, MPEG-1 Layer III (MP3), *DTS
- .ts, .trp, .tp, .mts, .m2ts
[Video] H.264/AVC, MPEG-2, AVS, VC1
[Audio] MPEG-1 Layer I, MPEG-1 Layer II, MPEG-1 Layer III (MP3), Dolby Digital, Dolby Digital Plus, AAC, HE-AAC, *DTS
- .vob
[Video] MPEG-1, MPEG-2
[Audio] Dolby Digital, MPEG-1 Layer I, MPEG-1 Layer II, DVD-LPCM
- .mp4, .m4v, .mov
[Video] MPEG-2, MPEG-4 Part2, DivX3.11, DivX4, DivX5, DivX6, XViD, H.264/AVC
[Audio] AAC, MPEG-1 Layer III (MP3), *DTS
- .mkv
[Video] MPEG-2, MPEG-4 Part2, DivX3.11, DivX4, DivX5, DivX6, XViD, H.264/AVC
[Audio] HE-AAC, Dolby Digital, MPEG-1 Layer III (MP3), *DTS, LPCM
- motion JPEG
[Video] MJPEG
[Audio] LPCM, ADPCM

- .mpg, .mpeg, .mpe
[Video] MPEG-1, MPEG-2
[Audio] MPEG-1 Layer I, MPEG-1 Layer II, Dolby Digital, LPCM
- .dat
[Video] MPEG-1, MPEG-2
[Audio] MP2
- .flv
[Video] Sorenson H.263, H.264/AVC
[Audio] MP3, AAC, HE-AAC
- *.rm, *.rmvb
[Video] RV30, RV40
[Audio] Dolby Digital, AAC, HE-AAC, RA6(Cook)
- 3gp, 3gp2
[Video] H.264/AVC, MPEG-4 Part2
[Audio] AAC, AMR(NB/WB)
- *DTS / *.rm / *.rmvb : Depending upon model

Supported Audio Formats

- File type : mp3
[Bit rate] 32 Kbps - 320 Kbps
[Sample freq.] 16 kHz - 48 kHz
[Support] MPEG1, MPEG2, Layer2, Layer3
- File Type : AAC
[Bit rate] Free Format
[Sample freq.] 8 kHz ~ 48 kHz
[Support] ADIF, ADTS
- File Type : M4A
[Bit rate] Free Format
[Sample freq.] 8 kHz ~ 48 kHz
[Support] MPEG-4
- File Type : WMA
[Bit rate] 128 Kbps ~ 320 Kbps
[Sample freq.] 8 kHz ~ 48 kHz
[Support] WMA7, WMA8, WMA9 Standard
- File Type : WMA 10 Pro
[Bit rate] ~ 768 Kbps
[Channel / Sample freq.]
M0 : up to 2 Channel @ 48 kHz
(Except LBR mode),
M1 : up to 5.1 Channel @ 48 kHz,
M2 : up to 5.1 Channel @ 96 kHz
[Support] WMA 10 Pro
- File Type : OGG
[Bit rate] Free Format
[Sample freq.] ~ 48 kHz
[Support] OGG Vorbis

Supported Photo Formats

- Category : 2D (jpeg, jpg, jpe), 3D (jps)
[Available file type]
SOF0: Baseline,
SOF1 : Extend Sequential,
SOF2 : Progressive
[Photo size] Minimum : 64 x 64,
Maximum : Normal Type: 15360 (W) x 8640 (H),
Progressive Type : 1920 (W) x 1440 (H)
- Category : BMP
[Photo size] Minimum : 64 x 64
Maximum : 9600 x 6400
- Category : PNG
[Available file type] Interlace, Non-Interlace
[Photo size] Minimum : 64 x 64
Maximum : Interlace : 1200 x 800, Non-Interlace
: 9600 x 6400
- BMP and PNG format files may be slower to display than JPEG.

Open Source Software Notice Information

To obtain the source code under GPL, LGPL, MPL, and other open source licenses, that is contained in this product, please visit <http://opensource.lge.com>.

In addition to the source code, all referred license terms, warranty disclaimers and copyright notices are available for download.

LG Electronics will also provide open source code to you on CD-ROM for a charge covering the cost of performing such distribution (such as the cost of media, shipping, and handling) upon email request to opensource@lge.com. This offer is valid for three (3) years from the date on which you purchased the product.

Troubleshooting

The software may be updated for improvement in performance. The customer is responsible to ensure the compatibility of their equipment with any LG Electronics software. If needed, please consult with LG Electronics and update new software versions according to the guidance provided by LG Electronics.

- Cannot control the TV with the remote control.
 - Check if anything such as tape has been placed over the receiver.
 - Check if there is any obstacle between the product and the remote control.
 - Replace the batteries with new fresh ones.
- No image display and no sound is produced.
 - Check if the product is turned on.
 - Check if the power cord is connected to a wall outlet.

- Check if there is a problem in the wall outlet by connecting other products.
- The TV turns off suddenly.
 - Check the power control settings. The power supply may be interrupted.
 - Check if the **Off Time / Sleep Timer** feature is activated in the **TIME** settings.
 - If there is no signal while the TV is on, the TV will turn off automatically after 15 minutes of inactivity.

Licenses

Supported licenses may differ by model. For more information about licenses, visit www.lg.com.



Manufactured under license from Dolby Laboratories.

Dolby and the double-D symbol are trademarks of Dolby Laboratories.



The terms HDMI and HDMI High-Definition Multimedia Interface, and the HDMI logo are trademarks or registered trademarks of HDMI Licensing LLC in the United States and other countries.



This DivX Certified® device has passed rigorous testing to ensure it plays DivX® video. To play purchased DivX movies, first register your device at vod.divx.com. Find your registration code in the DivX VOD section of your device setup menu.

DivX Certified® to play DivX® video up to HD 1080p, including premium content.

DivX®, DivX Certified® and associated logos are trademarks of DivX, LLC and are used under license.

Covered by one or more of the following U.S. patents: 7,295,673; 7,460,668; 7,515,710; 7,519,274.

Key Codes

- This feature is not available for all models.

Code (Hexa)	Function	Note	Code (Hexa)	Function	Note
00	CH +, PR +	R/C Button	53	List	R/C Button
01	CH -, PR -	R/C Button	5B	Exit	R/C Button
02	Volume +	R/C Button	60	PIP(AD)	R/C Button
03	Volume -	R/C Button	61	Blue	R/C Button
06	> (Arrow Key / Right Key)	R/C Button	63	Yellow	R/C Button
07	< (Arrow Key / Left Key)	R/C Button	71	Green	R/C Button
08	Power	R/C Button	72	Red	R/C Button
09	Mute	R/C Button	79	Ratio / Aspect Ratio	R/C Button
0B	Input	R/C Button	91	AD (Audio Description)	R/C Button
0E	SLEEP	R/C Button	7A	User Guide	R/C Button
0F	TV, TV/RAD	R/C Button	7C	Smart / Home	R/C Button
10 - 19	* Number Key 0 - 9	R/C Button	7E	SIMPLINK	R/C Button
1A	Q.View / Flashback	R/C Button	8E	▶▶ (Forward)	R/C Button
1E	FAV (Favorite Channel)	R/C Button	8F	◀◀ (Rewind)	R/C Button
20	Text (Teletext)	R/C Button	AA	Info	R/C Button
21	T. Opt (Teletext Option)	R/C Button	AB	Program Guide	R/C Button
28	Return (BACK)	R/C Button	B0	▶ (Play)	R/C Button
30	AV (Audio / Video) Mode	R/C Button	B1	■ (Stop / File List)	R/C Button
39	Caption/Subtitle	R/C Button	BA	(Freeze / Slow Play / Pause)	R/C Button
40	∧ (Arrow Key / Cursor Up)	R/C Button	BB	Soccer	R/C Button
41	∨ (Arrow Key / Cursor Down)	R/C Button	BD	● (REC)	R/C Button
42	My Apps	R/C Button	DC	3D	R/C Button
43	Menu / Settings	R/C Button	99	AutoConfig	R/C Button
44	OK / Enter	R/C Button	9F	App / *	R/C Button
45	Q.Menu	R/C Button	9B	TV/PC	R/C Button
4C	List, - (ATSC Only)	R/C Button			

- Key code 4C (0x4C) is available on ATSC/ISDB models which use major/minor channel.
(For South Korea, Japan, North America, Latin America except Colombia models)

External Control Device Setup

• Image shown may differ from your TV.

Connect the USB to Serial converter/RS-232C input jack to an external control device (such as a computer or an A/V control system) to control the product's functions externally.

Note: The type of control port on the TV can be different between model series.

- Please be advised that not all models support this type of connectivity.
- Cable is not provided.

USB to Serial Converter with USB Cable

USB Type

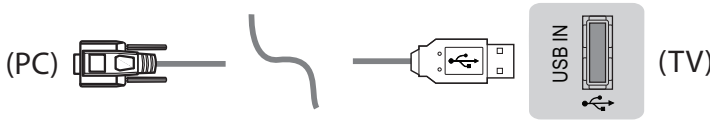

- LGTV supports PL2303 chip-based (Vendor ID : 0x0557, Product ID : 0x2008) USB to serial converter which is not made nor provided by LG.
- It can be purchased from computer stores that carry accessories for IT support professionals.

RS-232C With RS232C Cable

DE9 (D-Sub 9-pin) Type

- You need to purchase the RS-232C (DE9, D-Sub 9-pin female-to-female type) to RS-232C cable required for the connection between the PC and the TV, which is specified in the manual.
- The connection interface may differ from your TV.



Phone jack Type

- You need to purchase the phone-jack to RS-232 cable required for the connection between the PC and the TV, which is specified in the manual.
- For other models, connect to the USB port.
- The connection interface may differ from your TV.

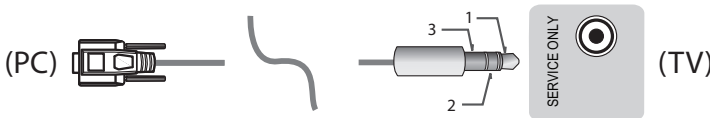

- or

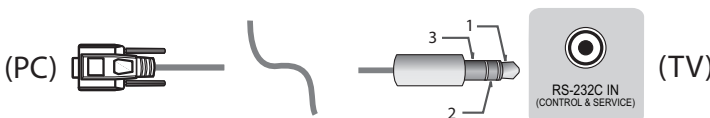

Customer Computer

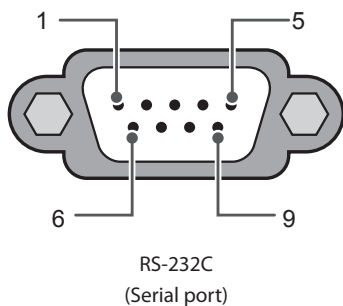

RS-232C Configurations

3-Wire Configurations(Not standard)

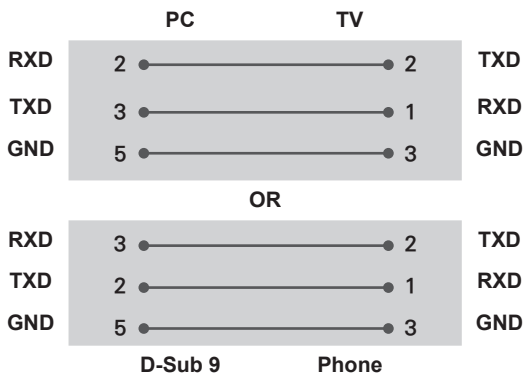

Set ID

For Set ID number, see **Real Data Mapping**.

1. Press **SETTINGS** to access the main menus.
2. Press the navigation buttons to scroll to (**General** → **About this TV or OPTION**) and press **OK**.
3. Press the navigation buttons to scroll to **SET ID** and press **OK**.
4. Scroll left or right to select a set ID number and select **CLOSE**. The adjustment range is 1-99.
5. When you are finished, press **EXIT**.
* (Depending upon model)

Communication Parameters

- Baud rate : 9600 bps (UART)
- Data length : 8 bits
- Parity : None
- Stop bit : 1 bit
- Communication code : ASCII code
- Use a crossed (reverse) cable.

Command Reference List

(Depending upon model)

	COMMAND1	COMMAND2	DATA (Hexadecimal)		COMMAND1	COMMAND2	DATA (Hexadecimal)
01. Power*	k	a	00 to 01	15. Balance	k	t	00 to 64
02. Aspect Ratio	k	c	(page 22)	16. Color (Colour) Temperature	x	u	00 to 64
03. Screen Mute	k	d	(page 22)	17. ISM Method (Only Plasma TV)	j	p	(page 24)
04. Volume Mute	k	e	00 to 01	18. Equalizer	j	v	(page 24)
05. Volume Control	k	f	00 to 64	19. Energy Saving	j	q	00 to 05
06. Contrast	k	g	00 to 64	20. Tune Command	m	a	(page 24)
07. Brightness	k	h	00 to 64	21. Channel (Programme) Add/Del(Skip)	m	b	00 to 01
08. Color/Colour	k	i	00 to 64	22. Key	m	c	Key Codes
09. Tint	k	j	00 to 64	23. Control Backlight, Control Panel Light	m	g	00 to 64
10. Sharpness	k	k	00 to 32	24. Input select (Main)	x	b	(page 26)
11. OSD Select	k	l	00 to 01	25. 3D (Only 3D models)	x	t	(page 26)
12. Remote Control Lock Mode	k	m	00 to 01	26. Extended 3D (Only 3D models)	x	v	(page 27)
13. Treble	k	r	00 to 64	27. Auto Configure	j	u	(page 27)
14. Bass	k	s	00 to 64				

* Note: During playing or recording media, all commands except Power (ka) and Key (mc) are not executed and treated as NG.
With RS232C cable, TV can communicate **ka command** in power-on or power-off status. but with USB-to-Serial converter cable, the command works only if TV is on.

Transmission / Receiving Protocol

Transmission

[Command1][Command2][][Set ID][][Data][Cr]

[Command 1] First command to control the TV. (j, k, m or x)

[Command 2] Second command to control the TV.

[Set ID] You can adjust the [Set ID] to choose desired monitor ID number in option menu. Adjustment range in TV is 1 to 99. If [Set ID] value is selected to '0', every connected set can be controlled.

* [Set ID] is indicated as decimal (1 to 99) on menu and as Hexadecimal (0x00 to 0x63) on transmission/receiving protocol.

[DATA] To transmit command data (hexadecimal). Transmit 'FF' data to read status of command.

[Cr] Carriage Return - ASCII code '0x0D'

[] Space - ASCII code '0x20'

OK Acknowledgement

[Command2][][Set ID][][OK][Data][x]

The set transmits ACK (acknowledgement) based on this format when receiving normal data. At this time, if the data is data read mode, it indicates present status data. If the data is data write mode, it returns the data of the PC computer.

Error Acknowledgement

[Command2][][Set ID][][NG][Data][x]

The set transmits ACK (acknowledgement) based on this format when receiving abnormal data from non-viable functions or communication errors.

Data 00: Illegal Code

Real Data Mapping (Hexadecimal : Decimal)

- When you enter the [data] in hexadecimal, refer to following conversion table.
- Channel Tune (ma) Command uses two-byte hexadecimal value([data]) to select channel number.

00 : Step 0	32 : Step 50 (Set ID 50)	FE : Step 254
01 : Step 1 (Set ID 1)	33 : Step 51 (Set ID 51)	FF : Step 255
...
0A : Step 10 (Set ID 10)	63 : Step 99 (Set ID 99)	01 00 : Step 256
...
0F : Step 15 (Set ID 15)	C7 : Step 199	27 0E : Step 9998
10 : Step 16 (Set ID 16)	C8 : Step 200	27 0F : Step 9999
...

- Commands may work differently depending upon model and signal.

01. Power (Command: k a)

- ▶ To control Power *On or Off of the set.

Transmission[k][a][][Set ID][][Data][Cr]

Data 00 : Power Off

Data 00 : *Power On

Ack [a][][Set ID][][OK/NG][Data][x]

- ▶ To Show TV is Power On or *Off

Transmission [k][a][][Set ID][][FF][Cr]

Ack [a][][Set ID][][OK][Data][x]

- * Similarly, if other functions transmit 'FF' data based on this format, Acknowledgement feedback presents status about each function.

02. Aspect Ratio (Command: k c)

(Main Picture Size)

- ▶ To adjust the screen format. (Main picture format)
You can also adjust the screen format using the Aspect Ratio in the Q.MENU or PICTURE menu.

Transmission [k][c][][Set ID][][Data][Cr]

Data 01 : Normal screen (4:3)	07 : 14:9
02 : Wide screen(16:9)	(Europe, Colombia, Mid-East, Asia except South Korea and Japan)
04 : Zoom	09 : * Just Scan
05 : Zoom 2	0B : Full Wide
(Latin America except Colombia Only)	0C : Set by Program/Original
06 : Set by Program/Original	(Europe, Colombia, Mid-East, Asia except South Korea and Japan)
	10 to 1F : Cinema Zoom 1 to 16

Ack [c][][Set ID][][OK/NG][Data][x]

- Using the PC input, you select either 16:9 or 4:3 screen aspect ratio.
- In DTV/HDMI/Component mode (high-definition), Just Scan is available.
- Full wide mode may work differently based on model and is supported for DTV fully, and ATV, AV partially.

03. Screen Mute (Command: k d)

- ▶ To select screen mute on/off.

Transmission [k][d][][Set ID][][Data][Cr]

Data 00 : Screen mute off (Picture on)

Video mute off

01 : Screen mute on (Picture off)

10 : Video mute on

Ack [d][][Set ID][][OK/NG][Data][x]

- * In case of video mute on only, TV will display On Screen Display(OSD). But, in case of Screen mute on, TV will not display OSD.

04. Volume Mute (Command: k e)

- ▶ To control volume mute on/off.

You can also adjust mute using the MUTE button on remote control.

Transmission [k][e][][Set ID][][Data][Cr]

Data 00 : Volume mute on (Volume off)

01 : Volume mute off (Volume on)

Ack [e][][Set ID][][OK/NG][Data][x]

05. Volume Control (Command: k f)

- ▶ To adjust volume.

You can also adjust volume with the volume buttons on remote control.

Transmission [k][f][][Set ID][][Data][Cr]

Data Min : 00 to Max : 64

Ack [f][][Set ID][][OK/NG][Data][x]

06. Contrast (Command: k g)

- ▶ To adjust screen contrast.

You can also adjust contrast in the PICTURE menu.

Transmission [k][g][][Set ID][][Data][Cr]

Data Min : 00 to Max : 64

Ack [g][][Set ID][][OK/NG][Data][x]

07. Brightness (Command: k h)

- ▶ To adjust screen brightness.
You can also adjust brightness in the PICTURE menu.

Transmission [k][h][][Set ID][][Data][Cr]

Data Min : 00 to Max : 64

Ack [h][][Set ID][][OK/NG][Data][x]

08. Color/Colour (Command: k i)

- ▶ To adjust the screen Color(Colour).
You can also adjust colour in the PICTURE menu.

Transmission [k][i][][Set ID][][Data][Cr]

Data Min : 00 to Max : 64

Ack [i][][Set ID][][OK/NG][Data][x]

09. Tint (Command: k j)

- ▶ To adjust the screen tint.
You can also adjust tint in the PICTURE menu.

Transmission [k][j][][Set ID][][Data][Cr]

Data Red : 00 to Green : 64

Ack [j][][Set ID][][OK/NG][Data][x]

10. Sharpness (Command: k k)

- ▶ To adjust the screen sharpness.
You can also adjust sharpness in the PICTURE menu.

Transmission [k][k][][Set ID][][Data][Cr]

Data Min : 00 to Max : 32

Ack [k][][Set ID][][OK/NG][Data][x]

11. OSD Select (Command: k l)

- ▶ To select OSD (On Screen Display) on/off when controlling remotely.

Transmission [k][l][][Set ID][][Data][Cr]

Data 00 : OSD off

Data 01 : OSD on

Ack [l][][Set ID][][OK/NG][Data][x]

12. Remote control lock mode (Command: k m)

- ▶ To lock the front panel controls on the monitor and remote control.

Transmission [k][m][][Set ID][][Data][Cr]

Data 00 : Lock off

Data 01 : Lock on

Ack [m][][Set ID][][OK/NG][Data][x]

- * If you are not using the remote control, use this mode.

When main power is off & on (plug-off and plug-in, after 20 - 30 seconds), external control lock is released.

- * In the standby mode (DC off by off timer or 'ka', 'mc' command), and if key lock is on, TV will not turn on by power on key of IR & Local Key.

13. Treble (Command: k r)

- ▶ To adjust treble.
You can also adjust in the AUDIO menu.

Transmission [k][r][][Set ID][][Data][Cr]

Data Min : 00 to Max : 64

Ack [r][][Set ID][][OK/NG][Data][x]

- * (Depending upon model)

14. Bass (Command: k s)

- ▶ To adjust Bass.
You can also adjust in the AUDIO menu.

Transmission [k][s][][Set ID][][Data][Cr]

Data Min : 00 to Max : 64

Ack [s][][Set ID][][OK/NG][Data][x]

- * (Depending upon model)

15. Balance (Command: k t)

- ▶ To adjust balance.
You can also adjust balance in the AUDIO menu.

Transmission [k][t][][Set ID][][Data][Cr]

Data Min : 00 to Max : 64

Ack [t][][Set ID][][OK/NG][Data][x]

16. Color(Colour) Temperature (Command: x u)

- ▶ To adjust colour temperature. You can also adjust Color(Colour) Temperature in the PICTURE menu.

Transmission [x][u][][Set ID][][Data][Cr]

Data Min : 00 to Max : 64

Ack [u][][Set ID][][OK/NG][Data][x]

17. ISM Method (Command: j p) (Only Plasma TV)

- ▶ To control the ISM method. You can also adjust ISM Method in OPTION menu.

Transmission [j][p][][Set ID][][Data][Cr]

Data Min : 02: Orbiter

08: Normal

20: Color(Colour) Wash

Ack [p][][Set ID][][OK/NG][Data][x]

18. Equalizer (Command : j v)

- ▶ Adjust EQ of the set.

Transmission [j][v][][Set ID][][Data][Cr]

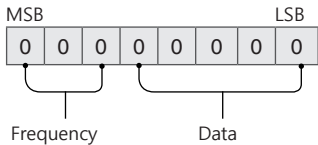

7	6	5	Frequency	4	3	2	1	0	Step
0	0	0	1 st Band	0	0	0	0	0	0 (decimal)
0	0	1	2 nd Band	0	0	0	0	1	1 (decimal)
0	1	0	3 rd Band
0	1	1	4 th Band	1	0	0	1	1	19 (decimal)
1	0	0	5 th Band	1	0	1	0	0	20 (decimal)

Acknowledgement [v][][Set ID][][OK/NG][Data][x]

* It depends on model, and can adjust when sound mode is EQ adjustable value.

19. Energy Saving (Command: j q)

- ▶ To reduce the power consumption of the TV. You can also adjust Energy Saving in PICTURE menu.

Transmission [j][q][][Set ID][][Data][Cr]

Data

00 : Off

01 : Minimum

02 : Medium

03 : Maximum

04 : Auto (For LCD TV / LED TV) / Intelligent sensor (For PDP TV)

05 : Screen off

* (Depending upon model)

Ack [q][][Set ID][][OK/NG][Data][x]

20. Tune Command (Command: m a)

- * This command may work differently depending upon model and signal.
- For Europe, Mid-East, Colombia, Asia except South Korea and Japan Model

- ▶ Select channel to following physical number.

Transmission [m][a][][Set ID][][Data 00][][Data 01][][Data 02][Cr]

* Analog Antenna/Cable

[Data 00][Data 01] Channel Data

Data 00 : High byte channel data

Data 01 : Low byte channel data

- 00 00 ~ 00 C7 (Decimal : 0 ~ 199)

Data 02 : Input Source (Analog)

- 00 : Antenna TV (ATV)

- 80 : Cable TV (CATV)

* Digital Antenna/Cable/Satellite

[Data 00][Data 01]: Channel Data

Data 00 : High Channel data

Data 01 : Low Channel data

- 00 00 ~ 27 0F (Decimal: 0 ~ 9999)

Data 02 : Input Source (Digital)

- 10 : Antenna TV (DTV)

- 20 : Antenna Radio (Radio)

- 40 : Satellite TV (SDTV)

- 50 : Satellite Radio (S-Radio)

- 90 : Cable TV (CADTV)

- a0 : Cable Radio (CA-Radio)

* Tune Command Examples:

1. Tune to the Analog antenna (PAL) Channel 10.

Set ID = All = 00

Data 00 & 01 = Channel Data is 10 = 00 0a

Data 02 = Analog Antenna TV = 00

Result = ma 00 00 0a 00

2. Tune to the digital antenna (DVB-T) Channel 01.

Set ID = All = 00

Data 00 & 01 = Channel Data is 1 = 00 01

Data 02 = Digital Antenna TV = 10

Result = ma 00 00 01 10

3. Tune to the satellite (DVB-S) Channel 1000.
 Set ID = All = 00
 Data 00 & 01 = Channel Data is 1000 = 03 E8
 Data 02 = Digital Satellite TV = 40
 Result = **ma 00 03 E8 40**

```
Ack [a][ ][Set ID][ ][OK][Data 00][Data 01]
[Data 02][x][a][ ][Set ID][ ][NG][Data 00][x]
```

- For South Korea, North/Latin America except Colombia Model
- ▶ To tune channel to following physical/major/minor number.

```
Transmission [m][a][ ][0][ ][Data00][ ][Data01]
[ ][Data02][ ][Data03][ ][Data04][ ][Data05][Cr]
```

Digital channels have a Physical, Major, and Minor channel number. The Physical number is the actual digital channel number, the Major is the number that the channel should be mapped to, and the Minor is the sub-channel. Since the ATSC tuner automatically maps the channel from the Major / Minor number, the Physical number is not required when sending a command in Digital.

- * Analog Antenna/Cable

Data 00 : Physical Channel Number
 - Antenna (ATV) : 02~45 (Decimal: 2 ~ 69)
 - Cable (CATV) : 01, 0E~7D (Decimal: 1, 14~125)

[Data 01 ~ 04]: Major/Minor Channel Number

Data 01 & 02: xx (Don't care)
 Data 03 & 04: xx (Don't care)
 Data 05: Input Source (Analog)
 - 00 : Antenna TV (ATV)
 - 01 : Cable TV (CATV)

- * Digital Antenna/Cable

Data 00 : xx (Don't care)

[Data 01][Data 02]: Major Channel Number

Data 01 : High byte Channel Data
 Data 02 : Low byte Channel Data
 - 00 01 ~ 27 0F (Decimal: 1 ~ 9999)

[Data 03][Data 04]: Minor Channel Number

Data 03 : High byte Channel Data
 Data 04 : Low byte Channel Data

Data 05 : Input Source (Digital)

- 02 : Antenna TV (DTV) – Use Physical Channel Number
- 06 : Cable TV (CADTV) – Use Physical Channel Number
- 22 : Antenna TV (DTV) – Don't Use Physical Channel Number
- 26 : Cable TV (CADTV) - Don't Use Physical Channel Number
- 46 : Cable TV (CADTV) – Use Major Channel Number Only (One Part Channel)

Two bytes are available for each major and minor channel data, but usually the low byte is used alone (high byte is 0).

- * Tune Command Examples:

1. Tune to the Analog cable (NTSC) channel 35.

```
Set ID = All = 00
Data 00 = Channel Data is 35 = 23
Data 01 & 02 = No Major = 00 00
Data 03 & 04 = No Minor = 00 00
Data 05 = Analog Cable TV = 01
Total = ma 00 23 00 00 00 01
```

2. Tune to the digital antenna (ATSC) channel 30-3.

```
Set ID = All = 00
Data 00 = Don't know Physical = 00
Data 01 & 02 = Major is 30 = 00 1E
Data 03 & 04 = Minor is 3 = 00 03
Data 05 = Digital Antenna TV = 22
Total = ma 00 00 00 1E 00 03 22
```

```
Ack [a][ ][Set ID][ ][OK][Data 00][Data 01]
[Data 02][Data 03][Data 04][Data 05]
[x][a][ ][Set ID][ ][NG][Data 00][x]
```

- For Japan Model

- ▶ To tune channel to following physical/major/minor number.

```
Transmission [m][a][ ][0][ ][Data00][ ][Data01]
[ ][Data02][ ][Data03][ ][Data04][ ][Data05][Cr]
```

- * Digital Antenna/Satellite

Data 00: xx (Don't care)

[Data 01][Data 02]: Major Channel Number

Data 01: High byte Channel Data
 Data 02: Low byte Channel Data
 - 00 01 ~ 27 0F (Decimal: 1 ~ 9999)

[Data 03][Data 04]: Minor/Branch Channel Number
 (Don't care in Satellite)

Data 03: High byte Channel Data
 Data 04: Low byte Channel Data

Data 05 : Input Source (Digital/Satellite for Japan)

- 02 : Antenna TV (DTV)
- 07 : BS (Broadcasting Satellite)
- 08 : CS1 (Communication Satellite 1)
- 09 : CS2 (Communication Satellite 2)

* Tune Command Examples:

1. Tune to the digital antenna (ISDB-T) channel 17-1.
 Set ID = All = 00
 Data 00 = Don't know Physical = 00
 Data 01 & 02 = Major is 17 = 00 11
 Data 03 & 04 = Minor/Branch is 1 = 00 01
 Data 05 = Digital Antenna TV = 02
 Total = **ma 00 00 00 11 00 01 02**

2. Tune to the BS (ISDB-BS) channel 30.
 Set ID = All = 00
 Data 00 = Don't know Physical = 00
 Data 01 & 02 = Major is 30 = 00 1E
 Data 03 & 04 = Don't Care = 00 00
 Data 05 = Digital BS TV = 07
 Total = **ma 00 00 00 1E 00 00 07**

* This feature is varied based on the model.
 Ack [a][][Set ID][][OK][Data 00][Data 01]
 [Data 02][Data 03][Data 04][Data 05]
 [x][a][][Set ID][][NG][Data 00][x]

21. Channel (Programme) Add/Del(Skip) (Command: m b)

▶ To skip current channel(programme) for next time.
 Transmission [m][b][][Set ID][][Data][Cr]

Data 00 : Del(ATSC,ISDB)/Skip(DVB) 01 : Add
 Ack [b][][Set ID][][OK/NG][Data][x]

* Set the saved channel status to del(ATSC, ISDB)/skip(DVB) or add.

22. Key (Command: m c)

▶ To send IR remote key code.
 Transmission [m][c][][Set ID][][Data][Cr]

Data Key code - page 17.

Ack [c][][Set ID][][OK/NG][Data][x]

23. Control Backlight (Command: m g)

• For LCD TV / LED TV
 ▶ To control the backlight.
 Transmission [m][g][][Set ID][][Data][Cr]

Data Min : 00 to Max : 64

Ack [g][][Set ID][][OK/NG][Data][x]

• For Plasma TV

▶ To control the panel light.
 Transmission [m][g][][Set ID][][Data][Cr]

Data Min : 00 to Max : 64

Ack [g][][Set ID][][OK/NG][Data][x]

24. Input select (Command: x b)
 (Main Picture Input)

▶ To select input source for main picture.
 Transmission [x][b][][Set ID][][Data][Cr]

Data

00 : DTV	01 : CADTV
02 : Satellite DTV	10 : ATV
ISDB-BS (Japan)	
03 : ISDB-CS1 (Japan)	
04 : ISDB-CS2 (Japan)	
11 : CATV	
20 : AV or AV1	21 : AV2
40 : Component1	41 : Component2
60 : RGB	
90 : HDMI1	91 : HDMI2
92 : HDMI3	93 : HDMI4

Ack [b][][Set ID][][OK/NG][Data][x]

* This function depends on model and signal.

25. 3D(Command: x t) (only 3D models)
 (Depending upon model)

▶ To change 3D mode for TV.
 Transmission [x][t][][Set ID][][Data 00][][Data 01]
 [][Data 02][][Data 03][Cr]

* (Depending upon model)

Data Structure

[Data 00]	00 : 3D On
	01 : 3D Off
	02 : 3D to 2D
	03 : 2D to 3D
[Data 01]	00 : Top and Bottom
	01 : Side by Side
	02 : Check Board
	03 : Frame Sequential
	04 : Column interleaving
	05 : Row interleaving
[Data 02]	00 : Right to Left
	01 : Left to Right
[Data 03]	3D Effect(3D Depth): Min : 00 - Max : 14 (**transmit by Hexadecimal code)

- * If [Data 00] is 00 (3D On), [Data 03] has no meaning.
- * If [Data 00] is 01 (3D off) or 02 (3D to 2D), [Data 01], [Data 02] and [Data 03] have no meaning.
- * If [Data 00] is 03 (2D to 3D), [Data 01] and [Data 02] have no meaning.
- * If [Data 00] is 00 (3D On) or 03 (2D to 3D), [Data 03] works when 3D Mode (Genre) is manual only.
- * All 3D pattern options ([Data 01]) may not be available according to broadcasting/video signal.

[Data 00]	[Data 01]	[Data 02]	[Data 03]
00	O	O	O
01	X	X	X
02	X	X	X
03	X	O	O

X : don't care

Ack [t][][Set ID][][OK][Data00][Data01][Data02][Data03][x]
[t][][Set ID][][NG][Data00][x]

26. Extended 3D(Command: x v) (only 3D models) (Depending upon model)

- ▶ To change 3D option for TV.

Transmission [x][v][][Set ID][][Data 00][][Data 01][Cr]

[Data 00] 3D option
 00 : 3D Picture Correction
 01 : 3D Depth (3D Mode is Manual Only)
 02 : 3D Viewpoint
 06 : 3D Color Correction
 07 : 3D Sound Zooming
 08 : Normal Image View
 09 : 3D Mode (Genre)

[Data 01] It has own range for each 3D option determined by [Data 00].

- 1) When [Data 00] is 00
 00 : Right to Left
 01 : Left to Right
- 2) When [Data 00] is 01, 02
 Data Min: 0 - Max: 14 (*transmit by Hexadecimal code)

Data value range(0 - 20) converts Viewpoint range (-10 - +10) automatically (Depending upon model)

* This option works when 3D Mode (Genre) is manual only.

- 3) When [Data 00] is 06, 07
 00 : Off
 01 : On

- 4) When [Data 00] is 08
 00 : Revert to 3D video from 3D-to-2D converted 2D video
 01 : Change 3D video to 2D video, except 2D-to-3D video

* If conversion condition doesn't meet, command is treated as NG.

- 5) When [Data 00] is 09

00 : Standard
 02 : Cinema
 04 : Manual
 01 : Sport
 03 : Extreme
 05 : Auto

Ack [v][][Set ID][][OK][Data00][Data01][x]
[v][][Set ID][][NG][Data00][x]

27. Auto Configure (Command: j u) (Depending upon model)

- ▶ To adjust picture position and minimize image shaking automatically. It works only in RGB (PC) mode.

Transmission [j][u][][Set ID][][Data][Cr]

Data 01 : To set

Ack [u][][Set ID][][OK/NG][Data][x]

CHILD SAFETY:

PROPER TELEVISION PLACEMENT MATTERS



THE CONSUMER ELECTRONICS INDUSTRY CARES

- Manufacturers, retailers and the rest of the consumer electronics industry are committed to making home entertainment safe and enjoyable.
- As you enjoy your television, please note that all televisions – new and old- must be supported on proper stands or installed according to the manufacturer’s recommendations. Televisions that are inappropriately situated on dressers, bookcases, shelves, desks, speakers, chests, carts, etc., may fall over, resulting in injury.



TUNE IN TO SAFETY

- **ALWAYS** follow the manufacturer’s recommendations for the safe installation of your television.
- **ALWAYS** read and follow all instructions for proper use of your television.
- **NEVER** allow children to climb on or play on the television or the furniture on which the television is placed.
- **NEVER** place the television on furniture that can easily be used as steps, such as a chest of drawers.
- **ALWAYS** install the television where it cannot be pushed, pulled over or knocked down.
- **ALWAYS** route cords and cables connected to the television so that they cannot be tripped over, pulled or grabbed.



WALL OR CEILING MOUNT YOUR TELEVISION

- **ALWAYS** contact your retailer about professional installation if you have any doubts about your ability to safely mount your television.
- **ALWAYS** use a mount that has been recommended by the television manufacturer and has a safety certification by an independent laboratory (such as UL, CSA, ETL).
- **ALWAYS** follow all instructions supplied by the television and mount manufacturers.
- **ALWAYS** make sure that the wall or ceiling where you are mounting the television is appropriate. Some mounts are not designed to be mounted to walls and ceilings with steel studs or cinder block construction. If you are unsure, contact a professional installer.
- Televisions can be heavy. A minimum of two people is required for a wall or ceiling mount installation.



MOVING AN OLDER TELEVISION TO A NEW PLACE IN YOUR HOME

- Many new television buyers move their older CRT televisions into a secondary room after the purchase of a flat-panel television. Special care should be made in the placement of older CRT televisions.
- **ALWAYS** place your older CRT television on furniture that is sturdy and appropriate for its size and weight.
- **NEVER** place your older CRT television on a dresser where children may be tempted to use the drawers to climb.
- **ALWAYS** make sure your older CRT television does not hang over the edge of your furniture.



Declaration of Conformity

Trade Name: LG

Model: 32LX330C-UA, 42LX330C-UA, 49LX341C-UA,
55LX341C-UA, 60LX341C-UA, 65LX341C-UA,
42LX530S-UA

49LX540S-UA, 55LX540S-UA, 60LX540S-UA,
65LX540S-UA, 43LX310C-UA, 49LX310C-UA

Responsible Party: LG Electronics Inc.

Address: 1000 Sylvan Ave.

Englewood Cliffs NJ 07632

U.S.A

TEL: 201-266-2534

LG Customer Information Center

For inquires or comments, visit www.lg.com or call;

1-888-865-3026 USA, Commercial User

1-888-542-2623 CANADA

The model and serial numbers of the TV are located on the back and on one side of the TV. Record them below should you ever need service.

MODEL _____

SERIAL _____



ENGLISH Easy Setup Guide

Please read this manual carefully before operating your set and retain it for future reference.

ESPAÑOL Guía Rápida de Configuración

Lea atentamente este manual antes de poner en marcha el equipo y consérvelo para futuras consultas.

FRANÇAIS Guide de configuration rapide

Avant d'utiliser l'appareil, veuillez lire attentivement ce manuel et le conserver pour pouvoir vous y reporter ultérieurement.

LED TV

32LX330C

42LX330C

42LX530S

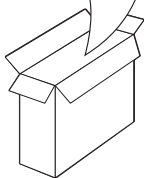
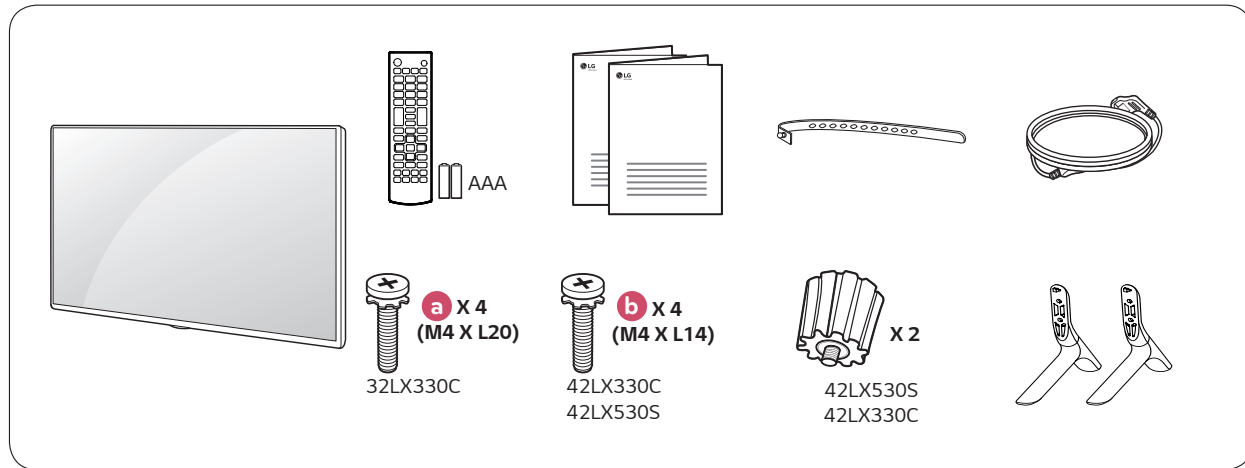

www.lg.com

P/NO : MFL68884902 (1504-REV01)



ENGLISH
ESPAÑOL
FRANÇAIS

Read **Safety and Reference.**
Leer **Seguridad y Consultas.**
Lisez **Sécurité et références.**

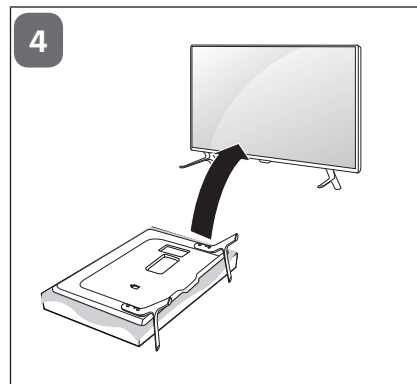
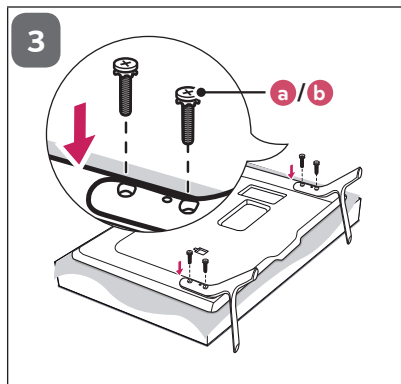
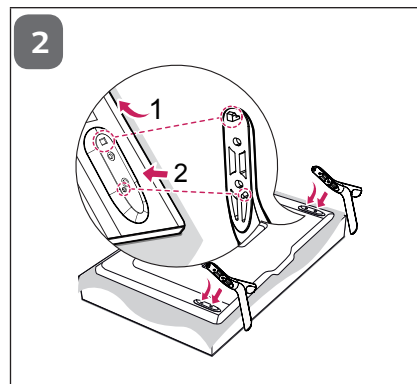
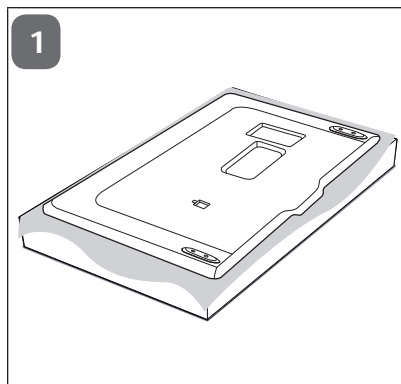

2

ENGLISH
ESPAÑOL
FRANÇAIS

Image shown may differ from your TV.
La imagen puede ser diferente a la de su televisor.
Cette illustration peut ne pas correspondre à votre téléviseur.

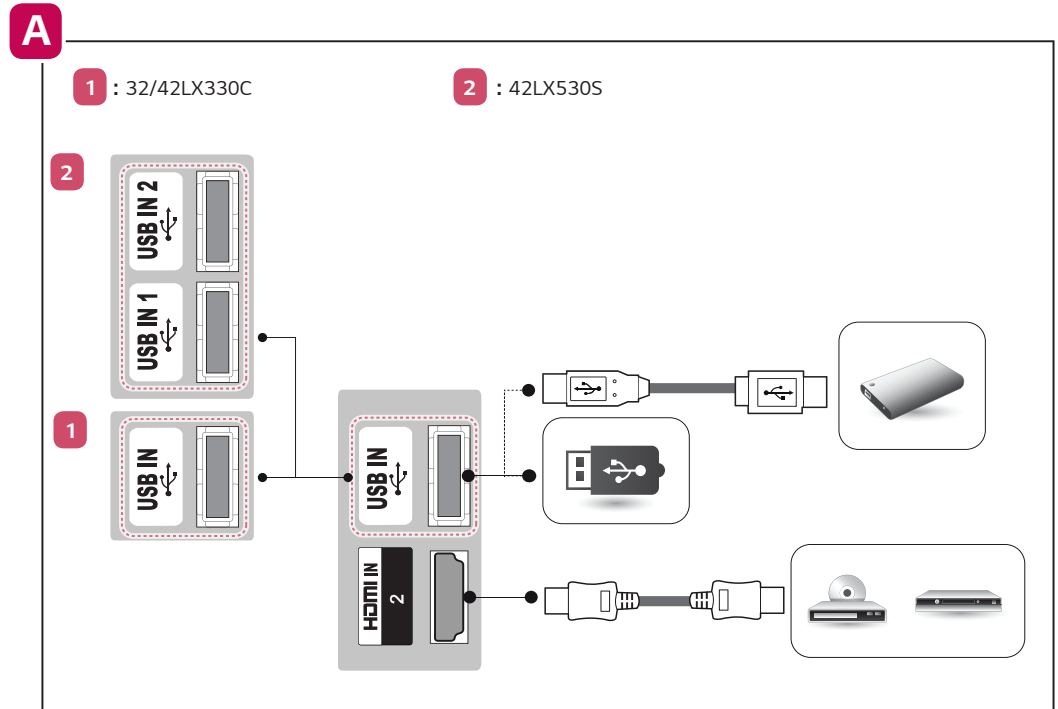
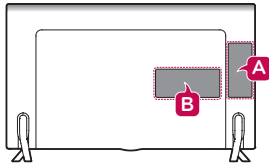

B

ENGLISH
ESPAÑOL
FRANÇAIS

Image shown may differ from your TV.
 La imagen puede ser diferente a la de su televisor.
 Cette illustration peut ne pas correspondre à votre téléviseur.

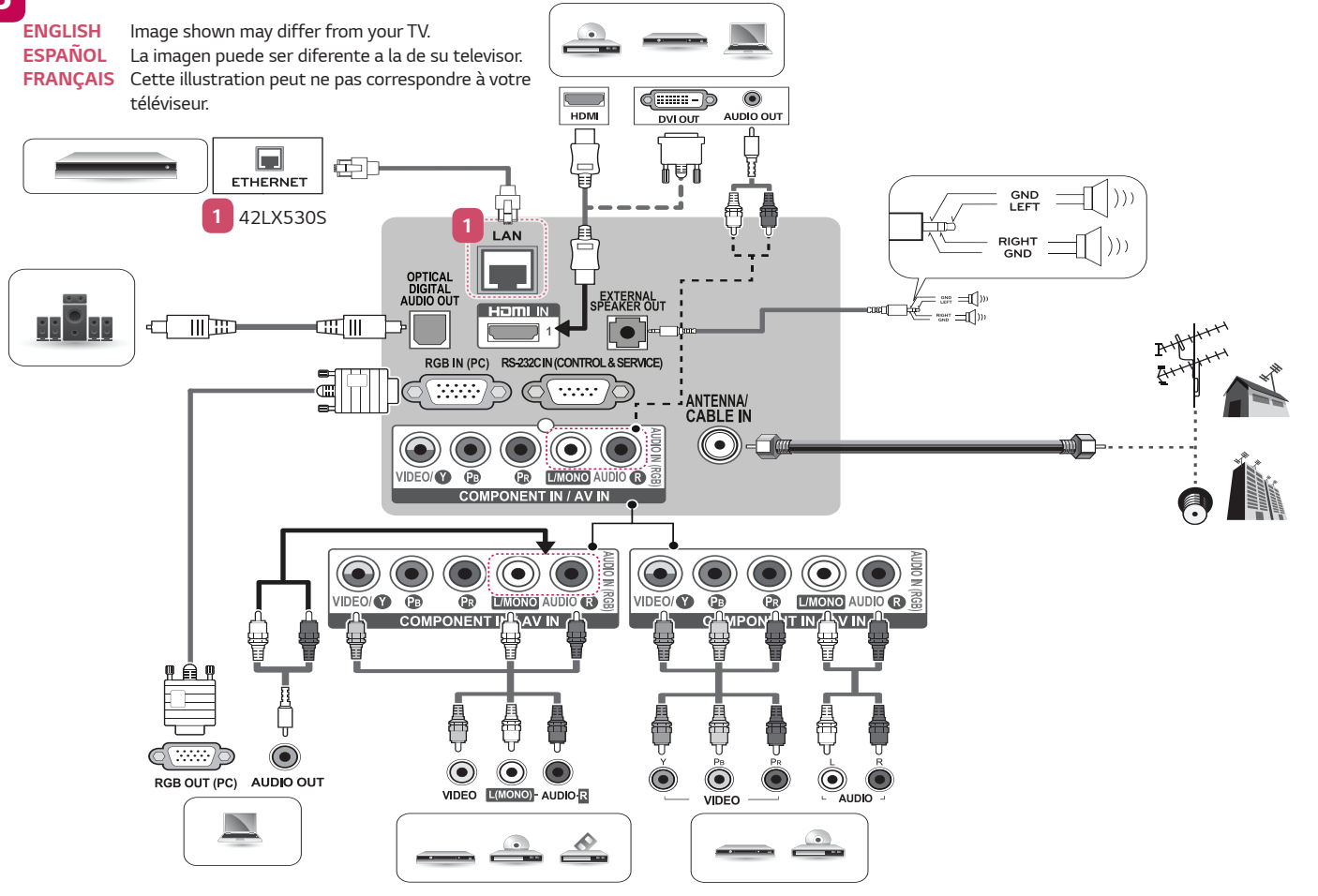

3

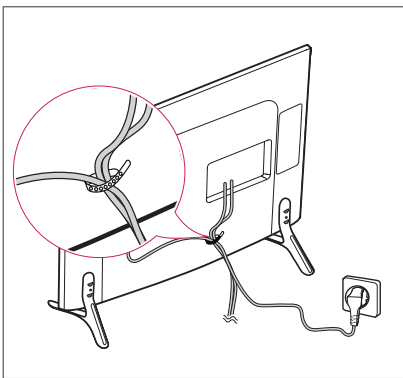

4

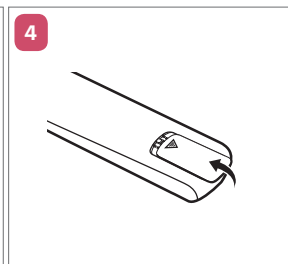
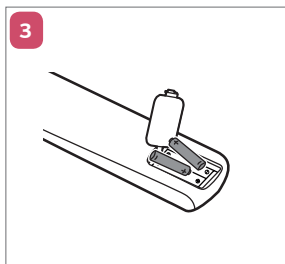
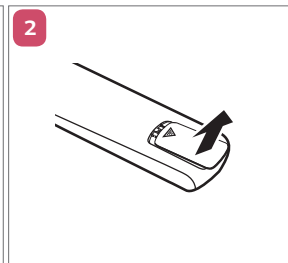
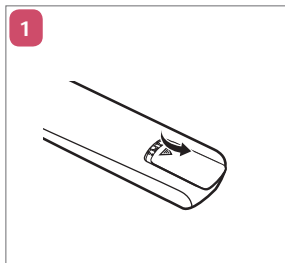
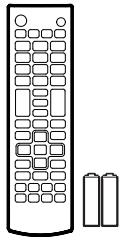

5

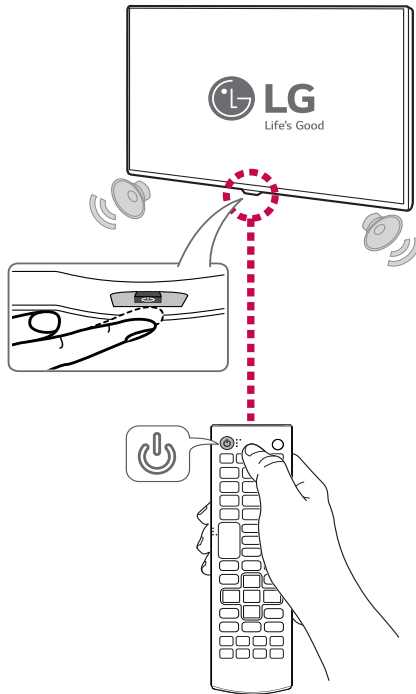

ENGLISH

MODELS		32LX330C (32LX330C-UA)	42LX330C (42LX330C-UA)
			42LX530S (42LX530S-UA)
Dimensions (W x H x D)	With stand	732 x 481 x 207 (mm) 28.8 x 18.9 x 8.1 (inches)	961 x 612 x 218 (mm) 37.8 x 24 x 8.5 (inches)
	Without stand	732 x 437 x 55.5 (mm) 28.8 x 17.2 x 2.1 (inches)	961 x 567 x 55.5 (mm) 37.8 x 22.3 x 2.1 (inches)
Weight	With stand	6.2 kg (13.6 lbs)	9.5 kg (20.9 lbs)
	Without stand	6.0 kg (13.2 lbs)	9.2 kg (20.2 lbs)
Power requirement		AC 100 - 240 V ~ 50 / 60 Hz	
Current value / Power consumption		1.1 A / 65 W	0.9 A / 90 W

ESPAÑOL
FRANÇAIS

MODELOS		32LX330C (32LX330C-UA)	42LX330C (42LX330C-UA)
MODÈLES			42LX530S (42LX530S-UA)
Dimensiones (Ancho x altura x profundidad)	Con base	732 x 481 x 207 (mm) 28,8 x 18,9 x 8,1 (pulgadas / pouces)	961 x 612 x 218 (mm) 37,8 x 24 x 8,5 (pulgadas / pouces)
	Avec support		
Dimensions (L x H x P)	Sin base	732 x 437 x 55,5 (mm) 28,8 x 17,2 x 2,1 (pulgadas / pouces)	961 x 567 x 55,5 (mm) 37,8 x 22,3 x 2,1 (pulgadas / pouces)
	Sans support		
Peso	Con base	6,2 kg (13,6 libras / lb)	9,5 kg (20,9 libras / lb)
	Avec support		
Poids	Sin base	6,0 kg (13,2 libras / lb)	9,2 kg (20,2 libras / lb)
	Sans support		
Potencia requerida Alimentation	AC 100 - 240 V ~ 50 / 60 Hz		
Corriente de consumo / Consumo de la potencia Valeur courante / Consommation électrique	1,1 A / 65 W		0,9 A / 90 W



(For USA and Canada only)
(Para Estados Unidos y Canadá)



This product qualifies for ENERGY STAR in the factory default (Home configuration) setting. Changing the factory default settings or enabling other features may increase power consumption that could exceed the limits necessary to qualify for ENERGY STAR. Refer to ENERGYSTAR.gov for more information on the ENERGY STAR program.

(Pour les États-Unis et le Canada)



Ce produit est conforme aux normes ENERGY STAR lorsque le réglage d'usine par défaut (Résidentiel) est sélectionné. Modifier les réglages d'usine par défaut ou activer d'autres fonctionnalités augmente la consommation d'énergie qui pourrait alors dépasser les limites de la qualification Energy Star. Consultez le site ENERGYSTAR.gov pour en savoir plus au sujet du programme ENERGY STAR.