

OWNER'S MANUAL

# AIR CONDITIONER

Please read this manual carefully before operating your set and retain it for future reference.

TYPE : WALL MOUNTED

SX092CL NL1

SX121CL NL2

SX122CL NL2

SX092CL US1

SX121CL US2

SX122CL US2

## TIPS FOR SAVING ENERGY

Here are some tips that will help you minimize the power consumption when you use the air conditioner. You can use your air conditioner more efficiently by referring to the instructions below:

- Do not cool excessively indoors. This may be harmful for your health and may consume more electricity.
- Block sunlight with blinds or curtains while you are operating the air conditioner.
- Keep doors or windows closed tightly while you are operating the air conditioner.
- Adjust the direction of the air flow vertically or horizontally to circulate indoor air.
- Speed up the fan to cool or warm indoor air quickly, in a short period of time.
- Open windows regularly for ventilation as the indoor air quality may deteriorate if the air conditioner is used for many hours.
- Clean the air filter once every 2 weeks. Dust and impurities collected in the air filter may block the air flow or weaken the cooling / dehumidifying functions.

This appliance is not intended for use by persons (including children) with reduced physical, sensory or mental capabilities, or lack of experience and knowledge, unless they have been given supervision or instruction concerning use of the appliance by a person responsible for their safety.

Children should be supervised to ensure that they do not play with the appliance.

WARNING: Before accessing the terminals, all power circuits must be disconnected.

WARNING: Fixed installations will incorporate disconnect means in accordance with installation rules.

WARNING: This device will not be accessible to public.

WARNING: The appliance must be installed in accordance with national regulations for electrical installations.

### *For your records*

Staple your receipt to this page in case you need it to prove the date of purchase or for warranty purposes. Write the model number and the serial number here:

Model number : \_\_\_\_\_

Serial number : \_\_\_\_\_

You can find them on a label on the side of each unit.

Dealer's name : \_\_\_\_\_

Date of purchase : \_\_\_\_\_

# IMPORTANT SAFETY INSTRUCTIONS

## **READ ALL INSTRUCTIONS BEFORE USING THE APPLIANCE.**

Always comply with the following precautions to avoid dangerous situations and ensure peak performance of your product

### **WARNING**

It can result in serious injury or death when the directions are ignored

### **CAUTION**

It can result in minor injury or product damage when the directions are ignored

### **WARNING**

- Always use a power plug and socket with a ground terminal. There is a risk of electric shock.
- Do not use a defective or underrated circuit breaker. Use the correctly rated breaker and fuse. There is risk of fire or electric shock .
- Do not use a multi consent. Always use this appliance on a dedicated circuit and breaker. Otherwise it can cause electric shock or fire.
- For electrical work, contact the dealer, seller, a qualified electrician, or an Authorized Service Center. Do not disassemble or repair the product by yourself. There is risk of fire or electric shock.
- Always ground the product as per the wiring diagram. Do not connect the ground wire to gas or water pipes lightning rod or telephone ground wire. There is risk of fire or electric shock.
- Install the panel and the cover of control box securely. There is risk of fire or electric shock due to dust , water etc.
- Use the correctly rated breaker or fuse. There is risk of fire or electric shock.
- Do not modify or extend the power cable. If the power cable or cord has scratches or skin peeled off or deteriorated then it must be replaced. There is risk of fire or electric shock.
- For installation, removal or reinstall , always contact the dealer or an Authorized Service Center. There is risk of fire, electric shock, explosion, or injury.
- Do not install the product on a defective installation stand. Be sure that the installation area does not deteriorate with age. It may cause product to fall.
- Never install the outdoor unit on a moving base or a place from where it can fall down. The falling outdoor unit can cause damage or injury or even death of a person.
- When the product is soaked (flooded or submerged) in water , contact an Authorized Service Center for repair before using it again. There is risk of fire or electric shock.
- In outdoor unit the step-up capacitor supplies high voltage electricity to the electrical components. Be sure to discharge the capacitor completely before conducting the repair work. An charged capacitor can cause electrical shock.
- When installing the unit, use the installation kit provided with the product. Otherwise the unit may fall and cause severe injury.
- Be sure to use only those parts which are listed in the svc parts list. Never attempt to modify the equipment. The use of inappropriate parts can cause an electrical shock, excessive heat generation or fire.

## 4 IMPORTANT SAFETY INSTRUCTIONS

---

- Indoor/outdoor wiring connections must be secured tightly and the cable should be routed properly so that there is no force pulling the cable from the connection terminals. Improper or loose connections can cause heat generation or fire.
- Safely dispose off the packing materials. Like screws, nails, batteries, broken things etc after installation or svc and then tear away and throw away the plastic packaging bags. Children may play with them and cause injury.
- Make sure to check that the power cable plug is not dirty, loose or broken and then only insert the plug completely. Dirty, loose or broken power plug can cause electric shock or fire.
- Be sure to check the refrigerant to be used. Please read the label on the product. Incorrect refrigerant used can prevent the normal operation of the unit.
- Don't use a power cord, a plug or a loose socket which is damaged. Otherwise it may cause a fire or electrical shock.
- Do not touch, operate, or repair the product with wet hands. Hold the plug by hand when taking out. There is risk of electric shock or fire.
- Do not place a heater or other heating appliances near the power cable. There is risk of fire and electric shock.
- Do not allow water to run into electric parts. Install the unit away from water sources. There is risk of fire, failure of the product, or electric shock.
- Do not store or use or even allow flammable gas or combustibles near the product. There is risk of fire.
- Do not use the product in a tightly closed space for a long time. Perform ventilation regularly. Oxygen deficiency could occur and hence harm your health.
- Do not open the front grille of the product during operation. (Do not touch the electrostatic filter, if the unit is so equipped.) There is risk of physical injury, electric shock, or product failure.
- If strange sounds, smell or smoke comes from product. Immediately turn the breaker off or disconnect the power supply cable. There is risk of electric shock or fire.
- Ventilate the product room from time to time when operating it together with a stove, or heating element etc. Oxygen deficiency can occur and hence harm your health.
- Turn the main power off and unplug the unit when cleaning or repairing the product. There is risk of electric shock.
- When the product is not to be used for a long time, disconnect the power supply plug or turn off the breaker. There is risk of product damage or failure, or unintended operation.
- Take care to ensure that nobody especially kids could step on or fall onto the outdoor unit. This could result in personal injury and product damage.
- Take care to ensure that power cable could not be pulled out or damaged during operation. There is risk of fire or electric shock.
- Do not place ANYTHING on the power cable. There is risk of fire or electric shock.
- Do not plug or unplug the power supply plug to turn the unit ON/OFF. There is risk of fire or electric shock.
- When flammable gas leaks, turn off the gas and open a window for ventilation before turn the product on. Do not use the telephone or turn switches on or off. There is risk of explosion or fire.
- For inner cleaning, contact an Authorized Service Center or a dealer. Do not use harsh detergent that causes corrosion or damage on the unit. Harsh detergent may also cause failure of product, fire, or electronic shock.

 **CAUTION**

- Two or more people must lift and transport the product. Avoid personal injury.
- Do not install the product where it will be exposed to sea wind (salt spray) directly. It may cause corrosion on the product.
- Install the drain hose to ensure that the condensed water is drained away properly. A bad connection may cause water leakage.
- Keep level even when installing the product. To avoid vibration or noise.
- Do not install the product where the noise or hot air from the outdoor unit could damage or disturb the neighborhoods. It may cause a problem for your neighbors and hence dispute.
- Always check for gas (refrigerant) leakage after installation or repair of product. Low refrigerant levels may cause failure of product.
- Do not use the product for special purposes, such as preserving foods, works of art, etc. It is a consumer air conditioner, not a precision refrigeration system. There is risk of damage or loss of property.
- Do not block the inlet or outlet of air flow. It may cause product failure.
- Use a soft cloth to clean. Do not use harsh detergents, solvents or splashing water etc. There is risk of fire, electric shock, or damage to the plastic parts of the product.
- Do not touch the metal parts of the product when removing the air filter. There is risk of personal injury.
- Do not step on or put anything on the product. (outdoor units) There is risk of personal injury and failure of product.
- Always insert the filter securely after cleaning. Clean the filter every two weeks or more often if necessary. A dirty filter reduces the efficiency.
- Do not insert hands or other objects through the air inlet or outlet while the product is operating. There are sharp and moving parts that could cause personal injury.
- Be cautious when unpacking and installing the product. Sharp edges could cause injury.
- If the refrigerant gas leaks during the repair, do not touch the leaking refrigerant gas. The refrigerant gas can cause frostbite (cold burn)
- Do not tilt the unit when removing or uninstalling it. The condensed water inside can spill.
- Do not mix air or gas other than the specified refrigerant used in the system. If air enters the refrigerant system, an excessively high pressure results, causing equipment damage or injury.
- If the refrigerant gas leaks during the installation, ventilate the area immediately. Otherwise it can be harmful for your health.
- Dismantling the unit, treatment of the refrigerant oil and eventual parts should be done in accordance with local and national standards. Replace the all batteries in the remote control with new ones of the same type. Do not mix old and new batteries or different types of batteries. There is risk of fire or product failure.
- Do not recharge or disassemble the batteries. Do not dispose off batteries in a fire. They may burn or explode.
- If the liquid from the batteries gets onto your skin or clothes, wash it well with clean water. Do not use the remote if the batteries have leaked. The chemicals in batteries could cause burns or other health hazards.
- Do not let the air conditioner run for a long time when the humidity is very high and a door or a window is left open. Moisture may condense and wet or damage furniture.
- Do not expose your skin or kids or plants to the cool or hot air draft. This could harm to your health.
- If you eat the liquid from the batteries, brush your teeth and see doctor. Do not use the remote if the batteries have leaked. The chemicals in batteries could cause burns or other health hazards.
- Do not drink the water drained from the product. It is not sanitary and could cause serious health issues.
- Use a firm stool or ladder when cleaning, maintaining or repairing the product at an height. Be careful and avoid personal injury.

## TABLE OF CONTENTS

### **2 TIPS FOR SAVING ENERGY**

---

### **3 IMPORTANT SAFETY INSTRUCTIONS**

---

### **7 ELECTRICAL SAFETY**

---

- 7 Temporary Use of an Adapter
- 7 Temporary Use of an Extension Cord
- 7 Symbols used in this Manual

### **8 PRODUCT INTRODUCTION**

---

- 13 Indoor Unit
- 13 Operation Indication Lamps
- 13 Outdoor Unit

### **9 OPERATING INSTRUCTIONS**

---

- 9 How to insert the Batteries
- 9 Wireless Remote Controller Maintenance
- 9 Operating Method
- 10 Wireless Remote Controller
- 11 Operation Mode
- 12 Auto Mode
- 12 Cooling Mode
- 13 Dry Mode
- 13 Fan Only Operation Mode
- 14 Timer Mode--Timer On
- 14 Timer Mode--Timer Off
- 15 Sleep Mode

### **16 MAINTENANCE AND SERVICE**

---

- 17 Cleaning the Air Filter
- 17 Self-Diagnosis Function
- 17 Cleaning the 3M Filter
- 18 Troubleshooting Tips! Save time and money!
- 19 Specification

# ELECTRICAL SAFETY

## WARNING

- This appliance must be properly grounded. To minimize the risk of electric shock, you must always plug into a grounded outlet.
- Do not cut or remove the grounding prong from the power plug.
- Attaching the adapter ground terminal to the wall receptacle cover screw does not ground the appliance unless the cover screw is metal and not insulated, and the wall receptacle is grounded through the house wiring.
- If you have any doubt whether the air conditioner is properly grounded, have the wall receptacle and circuit checked by a qualified electrician.

## Temporary Use of an Adapter

We strongly discourage the use of an adapter due to potential safety hazards. For temporary connections, use only a genuine adapter, available from most local hardware stores. Ensure that the large slot in the adapter is aligned with the large slot in the receptacle for a proper polarity connection.

To disconnect the power cord from the adapter, use one hand on each to avoid damaging the ground terminal. Avoid frequently unplugging the power cord as this can lead to eventual ground terminal damage.

## WARNING

- Never use the appliance with a broken adapter.

## Temporary Use of an Extension Cord

We strongly discourage the use of an extension cord due to potential safety hazards.

## WARNING

- This appliance should be installed in accordance with national wiring regulations. This guide acts as a guide to help to explain product features.

## Symbols used in this Manual

 This symbol alerts you to the risk of electric shock.

 This symbol alerts you to hazards that may cause harm to the air conditioner.

 This symbol indicates special notes.

# PRODUCT INTRODUCTION

Here is a brief introduction of the indoor and outdoor units. Please see the information specific to your indoor unit type.

## Indoor Unit

### Standard split Type

Display panel LED indicators

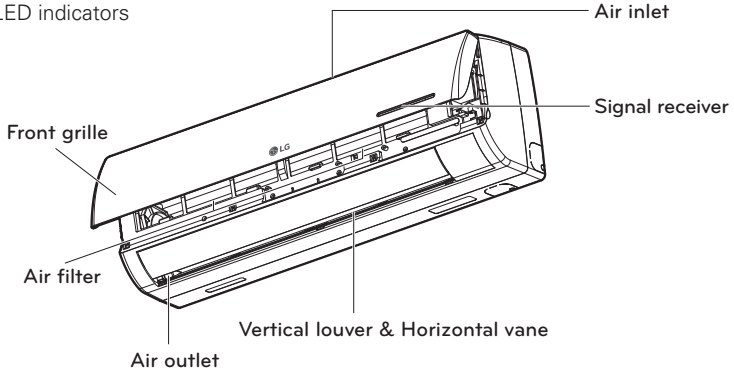

## Operation Indication Lamps

POWER : Light up while it is plugged in.

SLEEP : Light up during sleep mode auto operation.

TIMER : Light up during timer operation.

RUN : Light up during the system operation.

## Outdoor Unit

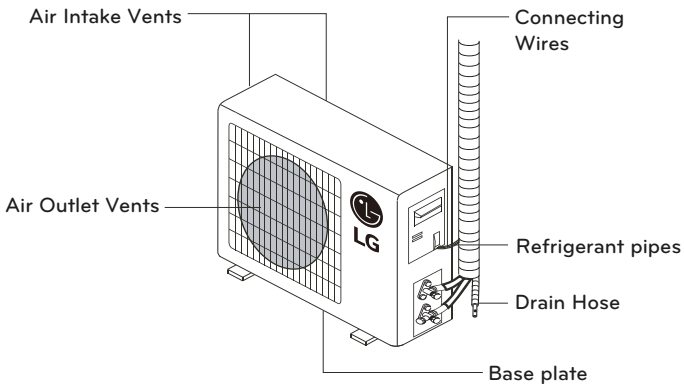

\* The feature can be changed according to type of model.



# OPERATING INSTRUCTIONS

## How to insert the Batteries

Remove the battery cover by pulling it according to the arrow direction. Insert new batteries making sure that the (+) and (-) of battery are installed correctly. Reattach the cover by sliding it back into position.

Use 2 AAA (1,5 Vcc) batteries. Do not rechargeable batteries.

Replace the old batteries with new ones of the same type when the display is no longer legible. The remote control batteries must be disposed of in accordance with the applicable laws in force in the country of use.

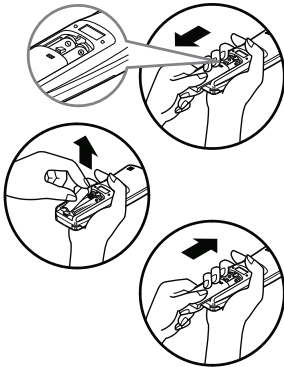

## ! NOTE

- Remote controller should never be exposed to direct sunlight.
- Signal transmitter & receiver should always be clean for proper communication. Use a soft cloth to clean them.
- In case some other appliances also get operated with remote control, change their

## Operating Method

- 1 The signal receiver is inside the unit.
- 2 Aim the remote controller towards the unit to operate it.  
There should not be any blockage in between.

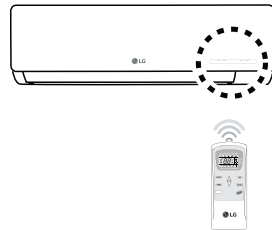



## Wireless Remote Controller Maintenance

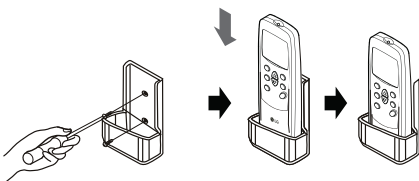











- 1 Choose a suitable place where its safe & easy to reach.
- 2 Fix the holder to wall etc with the supplied screws firmly.
- 3 Slide the remote controller inside the holder.



## Wireless Remote Controller

The controls will look like the following.

No.	Button	Function
1	On/Off	Used to turn off/on the unit.
2	SWING	Used to set the desired vertical airflow direction.
3	FAN	Used to select fan speed in four steps low, middle, high and auto wind.
4	SLEEP	Used to set sleep mode auto operation.
5	TIMER	Used to set and to cancel the timer operation.
6	MODE	Used to select the operation mode.
7		Decrease the temperature or time by 1 unit.
8		Increase the temperature or time by 1 unit.

Symbols	Meaning
	AUTO mode indicator
	COOLING indicator
	Dry indicator
	FAN ONLY OPERATION indicator
	SIGNAL RECEPTION indicator
	TIMER OFF indicator
	TIMER ON indicator
	AUTO FAN indicator
	LOW FAN SPEED indicator
	MIDDLE FAN SPEED indicator
	HIGH FAN SPEED indicator
	SLEEP indicator
	FLAP SWING indicator

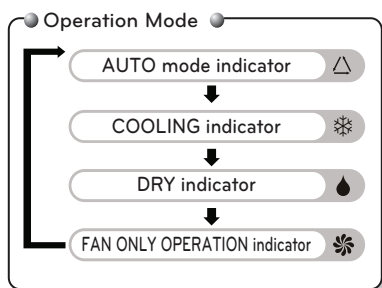
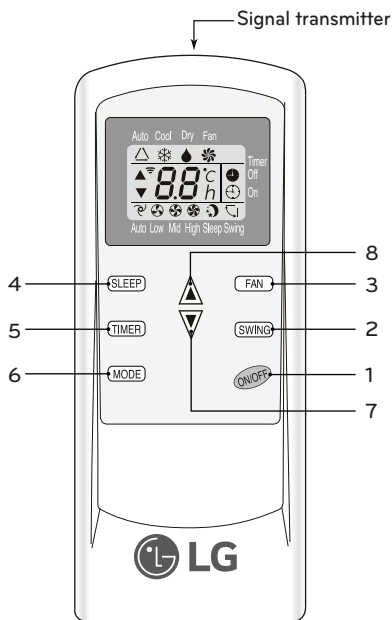

## Operation Mode

- 1** Press the ON/OFF BUTTON to Turn on the unit.  
The unit will respond with a beep.



- 2** Press the operation mode button. Each time the button is pressed, the operation mode is shifted in the direction of the arrow.

MODE

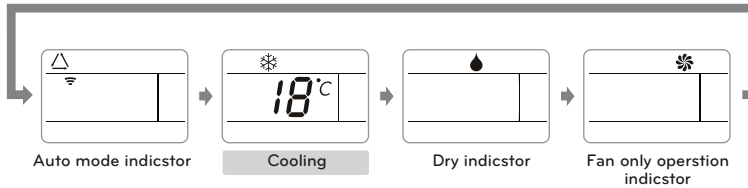

- 3** For cooling operation set the desired indoor temperature by pressing the ROOM TEMPERATURE SETTING BUTTONS.  
For cooling the temperature can be set within 18°C~31°C.

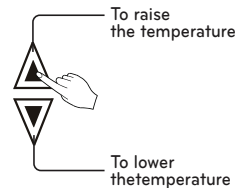

- 4** Set the fan speed with the remote controller.  
You can select the fan speed in four steps : low, middle, high and auto wind by pressing the FAN BUTTON.  
Each time the button is pressed, the fan speed mode is shifted in the direction of the arrow.

FAN

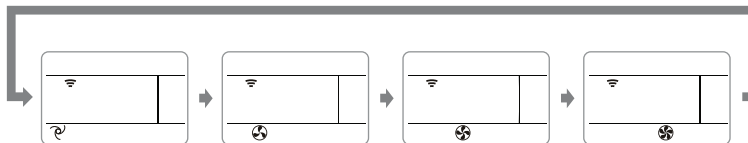

## Auto Mode

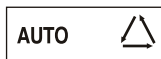

To activate the AUTO (automatic) mode of operation, press the Mode button on the remote control until the symbol appears in the display.

In the AUTO mode the fan speed and the temperature are set automatically according to the room temperature (tested by the probe which is incorporated in the indoor unit) to ensure user comfort.

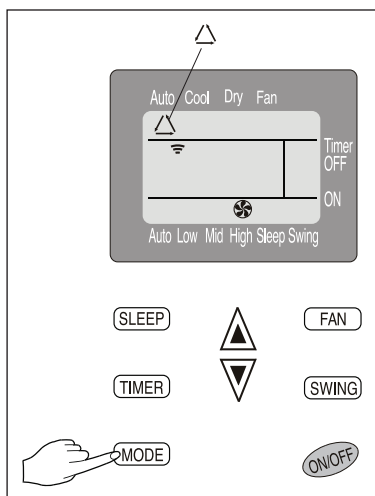

## Cooling Mode



The cooling function allows the air conditioner to cool the room and the room and at the same time reduces the humidity in the air.

To activate the cooling function (COOL), press the button (MODE) until the symbol ❄️ (COOL) appears in the display.

The cooling cycle is activated by setting the keys ▲ or ▼ at a temperature lower than that of the room.

To optimize the functioning of the conditioner, adjust the temperature (1), the speed (2) and the direction of the air flow (3) by pressing the keys indicated.

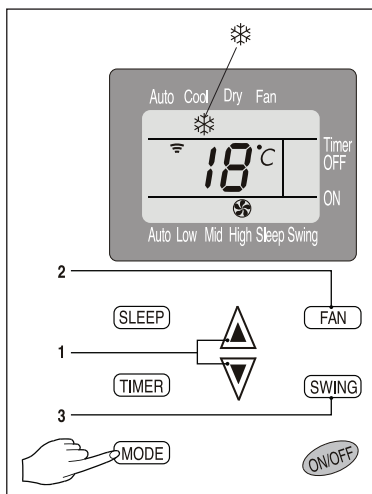

## Dry Mode



To set the DRY mode, Press **MODE** until  appears in the display. An automatic function of alternating cooling cycles and air fan is activated. the setting temperature is not displayed on the remote controller and you are not able to control the room temperature either. During the healthy dehumidification function, the fan speed is automatically set according to the optimization algorithm responding to the current room temperature status, so that the room condition is kept healthy and comfortable even in the very humid season.

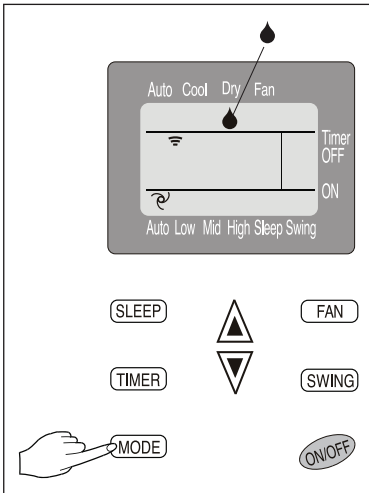

## Fan Only Operation Mode



The conditioner works in only Ventilation. To set the the Fan Only Operation Mode, Press **MODE** until(FAN) appears in the display.

With pressing **FAN** button the speed changes in the following sequence : LOW/MIDDLE/HIGH in FAN mode.

The remote control also stores the speed that was set in the previous mode of operation.

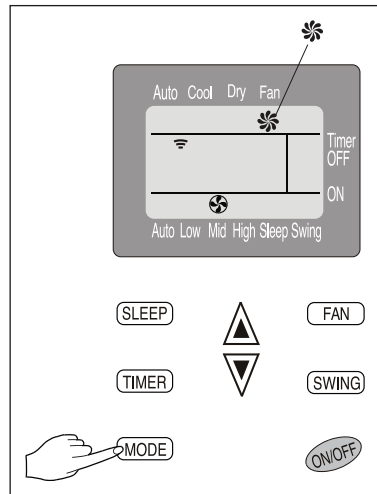

## Timer Mode--Timer On



To set the automatic switching-on of the air conditioner. To program the time start, the appliance should be off. Press TIMER, Set the temperature with pressing the ▲ or ▼ key.

Press TIMER Again, set the time with pressing the ▲ or ▼ key.

Press the key more times till on the display you can read the time which passes between the programming and the timed start.

### IMPORTANT!

Before proceeding with the timed start : program the working mode with the key MODE and the fan speed with the key FAN .

Switch the conditioner off (with the key ON/OFF ).

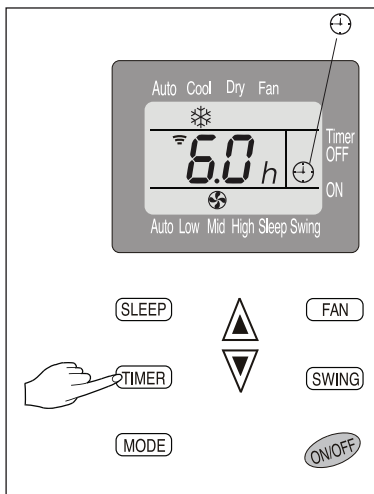

## Timer Mode--Timer Off



To set the automatic switching-off of the air conditioner. The timed stop is programmed with the appliance on. Press TIMER, Set the time pressing the key or, Press the key more times till on the display you can read the time which passes between the programming and the timed stop. The timer is programmed in half-hour increments From 0.5 hr to 10 hr and one-hour increments From 10 hr to 24 hr.

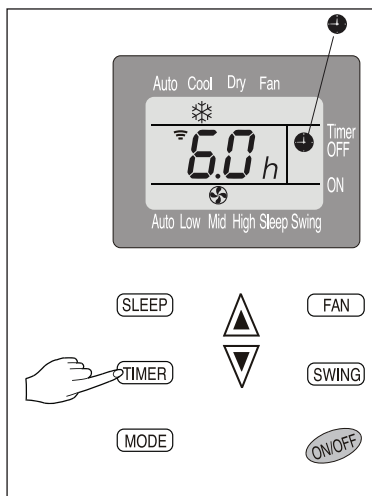

### NOTE

- To cancel the setted function, press the TIMER button again.
- In case of power off, it is necessary to set TIMER OFF again.
- While the time was right settled, the TIMER function of thus remote(clock function) can set by half hours.

## Sleep Mode



To activate the sleep mode of operation, press the SLEEP button on the remote control until the symbol appears in the display.

the function "SLEEP" automatically adjusts the temperature to make the room comfortable during the night sleep.

In the Cooling and Auto modes, the temperature increases by 1°C after 60 minutes and by a further 1°C after another 60 minutes for a more comfortable sleep.

The temperature increases with up to 2°C from the preset temperature.

After 10 hours running in sleep mode the air conditioner is switched off automatically

## Emergency Function

If the remote control is lost, proceed as follows: Lift the unit's front panel to reach the emergency button of the air conditioner if you press the button once (one beep), the air conditioner will work in forced cooling function.

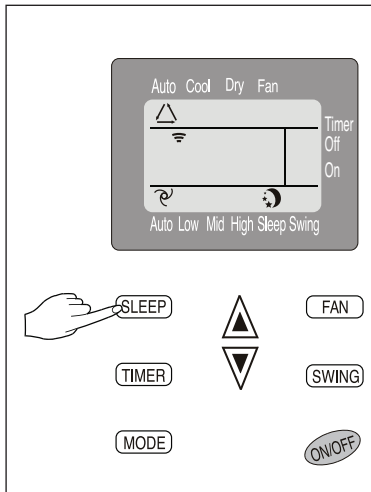
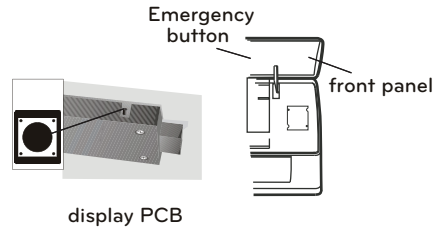

## MAINTENANCE AND SERVICE

Clean the product regularly to maintain optimal performance and to prevent possible breakdown.

\* This may not be provided, depending on the model.

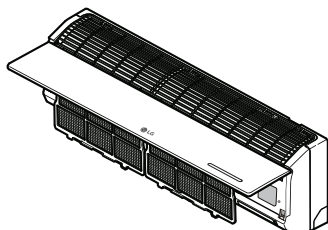

Air Filter

\* The feature can be changed according to type of model.

Item	Cleaning interval	Cleaning method
Air filter	2 weeks	See "Cleaning the air filter."
3M Filter	1 month	See "Cleaning the 3M Filter "
Indoor unit surface	Regularly	Use a soft, dry cloth. Do not use bleach or abrasives.
Outdoor unit	Regularly	Use steam to clean the heat exchanger coils and the panel vents (consult with technician).

### ⚠ CAUTION

- Turn off the power and unplug the power cord before you perform any maintenance; otherwise it may cause electric shock.
- Never use water that is hotter than 40°C(104°F) when you clean the filters. It may cause deformation or discoloration.
- Never use volatile substances when you clean the filters. They may damage the surface of the product.

### ! NOTE

- The location and shape of the filters may differ, depending on the model.
- Make sure to clean the heat exchanger coils of the outdoor unit regularly, as dirt collected in the coils may decrease the operational efficiency or increase energy costs.



## Cleaning the Air Filter

Clean the Air Filter once every 2 weeks or more if necessary.

- 1 Turn off the power and unplug the power cord.
- 2 Open the front cover.
  - Lift up both sides of the cover slightly.

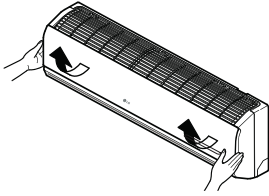

\* The feature can be changed according to type of model

- 3 Hold the knob of the dual protection filter, lift it up slightly and remove it from the unit.

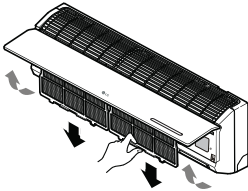

\* The feature can be changed according to type of model

- 4 Clean the filter with a vacuum cleaner or with warm water.
  - If dirt is difficult to remove, wash the filter in lukewarm water with detergent.
- 5 Dry the filter in the shade.

## Cleaning the 3M Filter

- 1 Turn off the power to the unit.
- 2 Open the front cover and remove the air filter (see "Cleaning air filter").
- 3 Remove the 3M Filter.

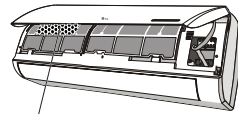
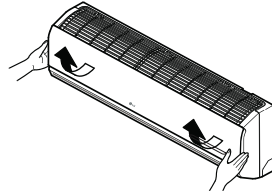

3M Filter

- 4 Use a vacuum cleaner to remove dirt, Do not wash the 3M Filter with water, because the filter can be damaged.
  - The location of the filters may differ, depending on the model.
  - We suggest changing the 3M Filter every 6 Months.
  - The feature can be changed according to type of model.

## Self-Diagnosis Function

In case of error, the display on the indoor unit shown the following error codes:

Code	RUN lamp	Description of the trouble
E1	flashes once	The fault of indoor temperature sensor
E2	flashes twice	The fault of indoor pipe temperature sensor
E6	flashes 6 times	Malfunction of indoor fan motor

## Troubleshooting Tips! Save time and money!

### Before requesting service

Please check the following before you contact the service center. If the problem persists, contact your local service center.

Problem	Possible causes	Corrective action
There is a burning smell and a strange sound coming from the unit.		Turn off the air conditioner, unplug the power cord and contact the service center.
Water leaks from the indoor unit even when the humidity level is low.		
The power cord is damaged or generating excessive heat.		
A switch, a circuit breaker (safety, ground) or a fuse is not operated properly.		
The air conditioner does not work.	The air conditioner is unplugged.	Check whether the power cord is plugged into the outlet.
	A fuse is blown or the power supply is blocked.	Replace the fuse or check if the circuit breaker has tripped.
	A power failure has occurred.	Turn off the air conditioner when a power failure occurs. When the power is restored, wait 3 minutes, and then turn on the air conditioner.
	The voltage is too high or too low.	Check if the circuit breaker has tripped.
	The air conditioner turned off automatically at a preset time.	Press the power button again.

Problem	Possible causes	Corrective action
The air conditioner does not generate cool air.	Air is not circulating properly.	Make sure that there are no curtains, blinds or furniture blocking the front of the air conditioner.
	The air filter is dirty.	Clean the air filter once every 2 weeks. See "Cleaning Air Filter" for more information.
	The room temperature is too high.	In summer, it may take some time to cool indoor air. In this case, select the jet cool operation to cool indoor air quickly.
	Cold air is escaping from the room.	Make sure that no cold air is escaping through ventilation points in the room.
	The desired temperature is higher than the set temperature.	Set the desired temperature to a level lower than the current temperature.
	There is a heating source nearby.	Avoid using a heat generator such as an electric oven or a gas burner while the air conditioner is in operation.
	Air circulation operation is selected.	In the air circulation operation, air blows from the air conditioner without cooling or heating the indoor air. Switch the operation mode to the cooling operation.
It is not possible to adjust the fan speed.	The auto operation, jet operation or dehumidifying operation is selected.	In some operation modes, such as the jet or dehumidifying operation modes, you cannot adjust the fan speed. Select an operation mode in which you can adjust the fan speed.
It is not possible to adjust the temperature.	The air circulation operation or jet operation is selected.	In some operation modes, such as the air circulation or jet operation mode, you cannot adjust the temperature. Select an operation mode in which you can adjust the temperature.

## Specification

Model	Voltage	Cooling		Heating	
		INPUT	CURRENT	INPUT	CURRENT
SX121CL	115 V	1 175 W	10,4 A	-	-
SX122CL	220 V	1 175 W	5,4 A	-	-
SX092CL	220 V	922 W	4,3 A	-	-





LG ELECTRONICS MEXICO,S.A. DE C.V.  
Sor Juana Inés de la Cruz No. 555  
Col. San Lorenzo Industrial  
Tlalnepantla de Baz,Estado de México C.P. 54033  
Teléfono : (55)5321-1919  
Sin Costo : 01800-3471919  
Pagina Web:<http://www.lg.com.mx/>