



LG

Life's Good

OWNER'S MANUAL LED TV*

* Disclaimer

LG LED TV applies LCD screen with LED backlights.

Please read this manual carefully before operating your set and retain it for future reference.

LY33**

LY34**

LY54**

TABLE OF CONTENTS

3 LICENSES

3 OPEN SOURCE SOFTWARE NOTICE

4 ASSEMBLING AND PREPARING

- 4 Unpacking
- 6 Parts and Button
- 7 Using the Joystick Button
- 8 Lifting and Moving the TV
- 9 Setting up the TV
 - 9 - Attaching the Stand
 - 10 - Mounting on a Table
 - 11 - Mounting on a Wall

12 MAKING CONNECTIONS

- 12 Antenna Connection
- 13 Adapter Connection
- 13 Network Setup
 - 13 - Wired Network Connection
- 14 Other Connections

18 REMOTE CONTROL

20 MAINTENANCE

- 20 Cleaning your TV
 - 20 - Screen, Frame, Cabinet and Stand
 - 20 - Power Cord

20 TROUBLESHOOTING

21 SPECIFICATIONS

23 IR CODES

24 EXTERNAL CONTROL DEVICE SETUP

- 24 RS-232C Setup
- 24 Type of Connector:
 - D-Sub 9-Pin Male
- 24 RS-232C Configurations
- 25 Communication Parameters
- 25 Command Reference List
- 26 Transmission / Receiving Protocol



WARNING

- If you ignore the warning message, you may be seriously injured or there is a possibility of accident or death.



CAUTION

- If you ignore the caution message, you may be slightly injured or the product may be damaged.



NOTE

- The note helps you understand and use the product safely. Please read the note carefully before using the product.

LICENSES



Supported licenses may differ by model. For more information about licenses, visit www.lg.com.



Manufactured under license from Dolby Laboratories.

“Dolby” and the double-D symbol are trademarks of Dolby Laboratories.



The terms HDMI and HDMI High-Definition Multimedia Interface, and the HDMI logo are trademarks or registered trademarks of HDMI Licensing LLC in the United States and other countries.



ABOUT DIVX VIDEO: DivX® is a digital video format created by DivX, LLC, a subsidiary of Rovi Corporation. This is an official DivX Certified® device that has passed rigorous testing to verify that it plays DivX video. Visit divx.com for more information and software tools to convert your files into DivX videos.

ABOUT DIVX VIDEO-ON-DEMAND: This DivX Certified® device must be registered in order to play purchased DivX Video-on-Demand (VOD) movies. To obtain your registration code, locate the DivX VOD section in your device setup menu. Go to vod.divx.com for more information on how to complete your registration.

“DivX Certified® to play DivX® video up to HD 1080p, including premium content.”

“DivX®, DivX Certified® and associated logos are trademarks of Rovi Corporation or its subsidiaries and are used under license.”

“Covered by one or more of the following U.S. patents :
7,295,673; 7,460,668; 7,515,710; 7,519,274”

OPEN SOURCE SOFTWARE NOTICE

To obtain the source code under GPL, LGPL, MPL and other open source licenses, that is contained in this product, please visit <http://opensource.lge.com>.

In addition to the source code, all referred license terms, warranty disclaimers and copyright notices are available for download.

LG Electronics will also provide open source code to you on CD-ROM for a charge covering the cost of performing such distribution (such as the cost of media, shipping and handling) upon email request to opensource@lge.com. This offer is valid for three (3) years from the date on which you purchased the product.

**NOTE**

- Image shown may differ from your TV.
- Your TV's OSD (On Screen Display) may differ slightly from that shown in this manual.
- The available menus and options may differ from the input source or product model that you are using.
- New features may be added to this TV in the future.
- The TV can be placed in standby mode in order to reduce the power consumption. And the TV should be turned off if it will not be watched for some time, as this will reduce energy consumption.
- The energy consumed during use can be significantly reduced if the level of brightness of the picture is reduced, and this will reduce the overall running cost.

ASSEMBLING AND PREPARING

Unpacking

Check your product box for the following items. If there are any missing accessories, contact the local dealer where you purchased your product. The illustrations in this manual may differ from the actual product and item.

**CAUTION**

- Do not use any unapproved items to ensure the safety and product life span.
- Any damages or injuries by using unapproved items are not covered by the manufacturer's warranty.
- Some models have a thin film attached on to the screen and this must not be removed.

**NOTE**

- The items supplied with your product may vary depending on the model.
- Product specifications or contents of this manual may be changed without prior notice due to upgrade of product functions.
- For an optimal connection, HDMI cables and USB devices should have bezels less than 10 mm thick and 18 mm width. Use an extension cable that supports USB 2.0 if the USB cable or USB FLASH DRIVE does not fit into your TV's USB port.

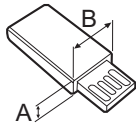
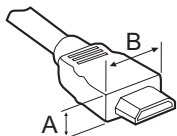

*A ≦ 10 mm

*B ≦ 18 mm

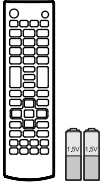

**Remote Control,
Batteries (AAA)**

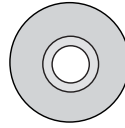

Owner's Manual

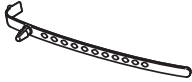

Cable Holder
(Depending on model)



Power Cord
(Depending on model)

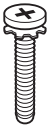

Stand Screws
4EA, M4 x L14
(Only 42/47LY34**,
39/42/47/55LY54**)

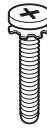

Stand Screws
4EA, M4 x L20
(Only 32LY34**, 32LY54**)

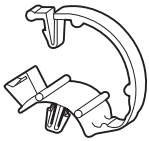

Cable Managements
2EA
(Only 32/42/47LY34**,
32/39/42/47/55LY54**)

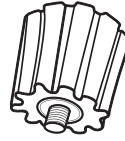

Wall Mount Spacers
2EA
(Only 42LY34**, 42LY54**)

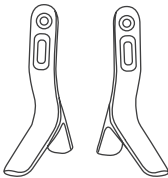

Stand Base
(Only 32/42/47LY34**,
32/39/42/47/55LY54**)

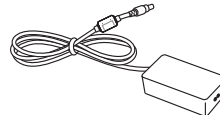

AC-DC Adaptor
(Only 28LY33**)
(Depending on model &
country)



or



Stand Base
(Only 28LY33**)
(Depending on model &
country)

Parts and Button

A type : 32/42/47LY34**, 32/39/42/47/55LY54**

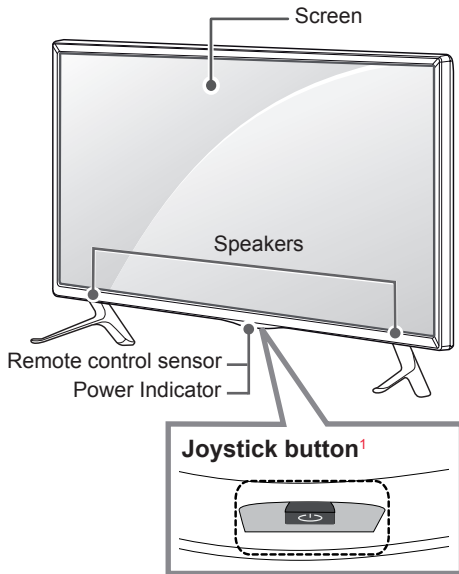

B type : 28LY33** (Except for India)

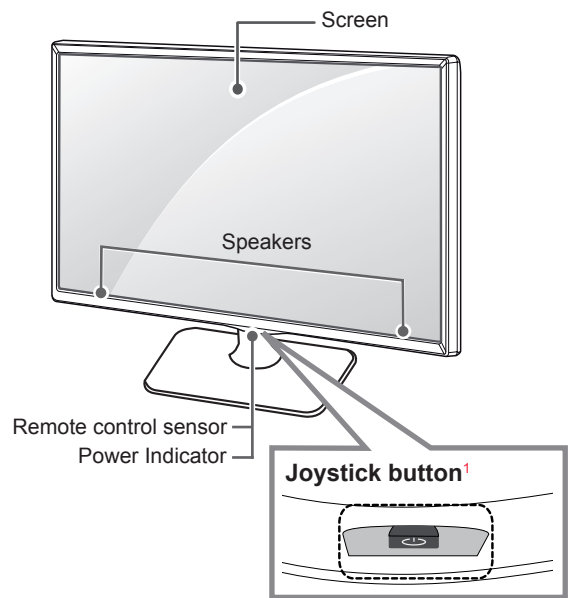

C type : 28LY33** (Only India)

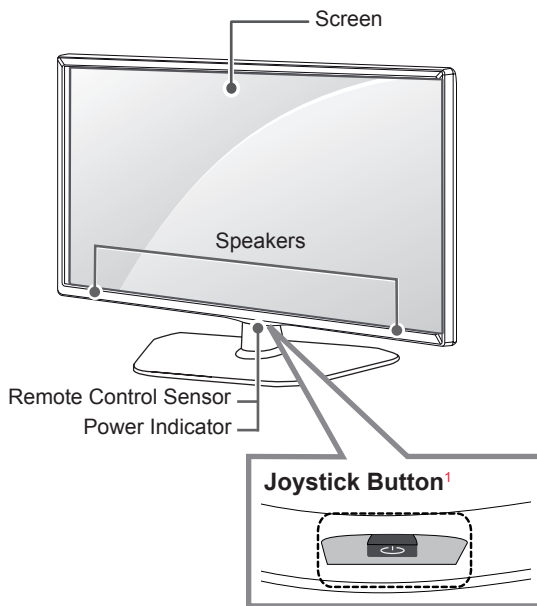

¹ Joystick Button - This button is located below the TV screen.



! NOTE

- You can set the power indicator light to on or off by selecting **OPTION** in the main menus.

Using the Joystick Button

You can simply operate the TV functions, pressing or moving the joystick button up, down, left or right.

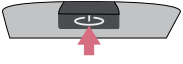
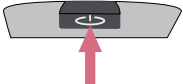
Basic Functions

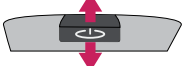
	Power On	When the TV is turned off, place your finger on the joystick button and press it once and release it.
	Power Off	When the TV is turned on, place your finger on the joystick button and press it once for a few seconds and release it. (However, if the Menu button is on the screen, pressing and holding the joystick button will let you exit the Menu.)
	Volume Control	If you place your finger over the joystick button and move it left or right, you can adjust the volume level you want.
	Programmes Control	If you place your finger over the joystick button and move it up or down, you can scrolls through the saved programmes you want.





! NOTE

- When your finger over the joystick button and push it to the up, down, left or right, be careful not to press the joystick button. If you press the joystick button first, you can not adjust the volume level and saved channels.

Adjusting the Menu

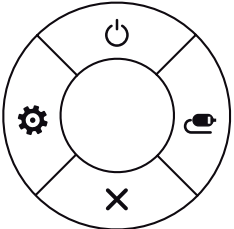
When the TV is turned on, press the joystick button one time.

You can adjust the Menu items (⏻, ⚙️, 📺, ✖️) moving the joystick button up, down, left or right.

		TV Off	Turn the power off.
		Settings	Accesses the main menu.
		Input List	Changes the input source.
		Close	Clears on-screen displays and return to TV viewing.

Lifting and Moving the TV

When moving or lifting the TV, read the following to prevent the TV from being scratched or damaged and for safe transportation regardless of its type and size.



CAUTION

- Avoid touching the screen at all times, as this may result in damage to the screen.
- It is recommended to move the TV in the box or packing material that the TV originally came in.
- Before moving or lifting the TV, disconnect the power cord and all cables.
- When holding the TV, the screen should face away from you to avoid damage.

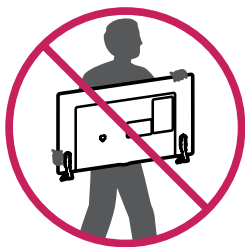

- Hold the top and bottom of the TV frame firmly. Make sure not to hold the transparent part, speaker, or speaker grill area.

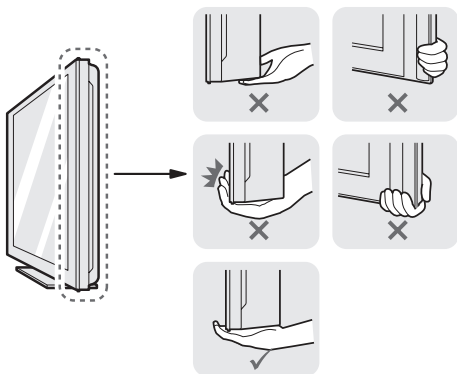

- When transporting a large TV, there should be at least 2 people.
- When transporting the TV by hand, hold the TV as shown in the following illustration.

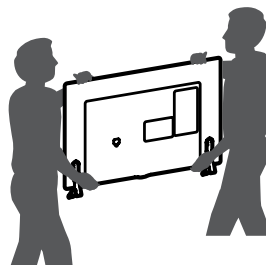

- When transporting the TV, do not expose the TV to jolts or excessive vibration.
- When transporting the TV, keep the TV upright, never turn the TV on its side or tilt towards the left or right.
- Do not apply excessive pressure to cause flexing /bending of frame chassis as it may damage screen.



CAUTION

- When handling the TV, be careful not to damage the protruding joystick button. (Depending on model)



Setting up the TV

Attaching the Stand

* Image shown may differ from your TV.

(Only 32/42/47LY34**, 32/39/42/47/55LY54**)

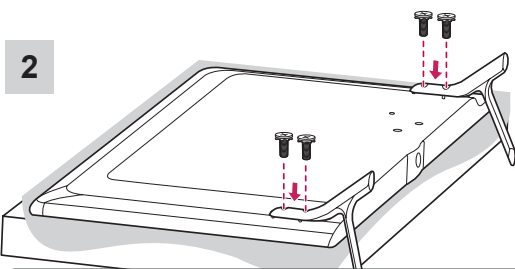
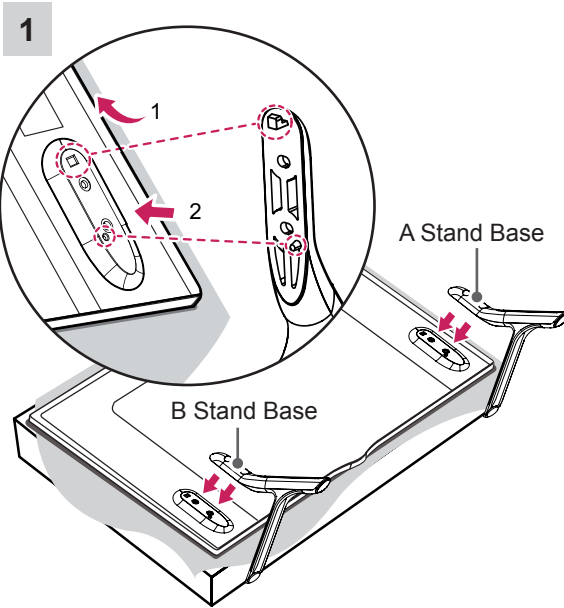

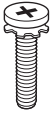
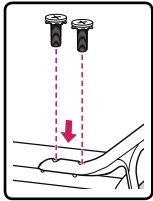
	M4 x L14 (Only 42/47LY34**, 39/42/47/55LY54**)	
	M4 x L20 (Only 32LY34**, 32LY54**)	
4EA		

(Only 28LY33**)

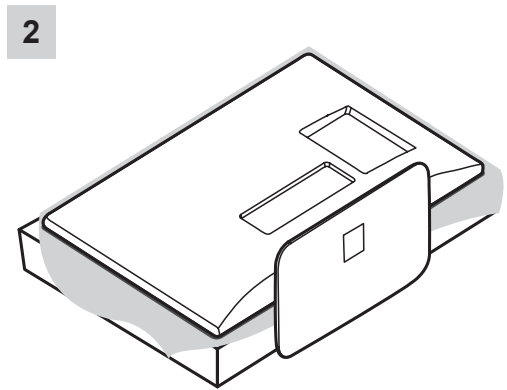
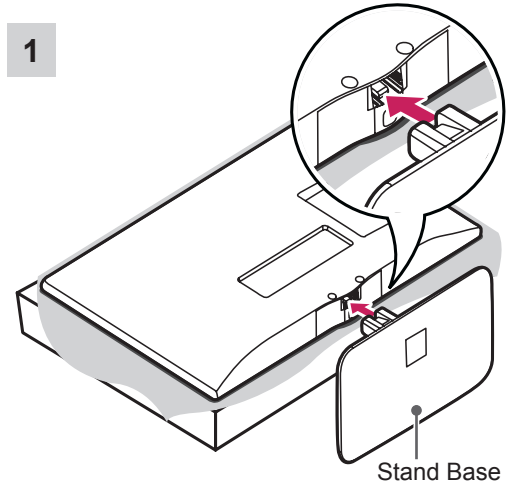

! CAUTION

- When attaching the stand to the TV, place the screen facing down on a cushioned table or flat surface to protect the screen from scratches.

Mounting on a Table

- Lift and tilt the TV into its upright position on a table.
 - Leave a 10 cm (minimum) space from the wall for proper ventilation.

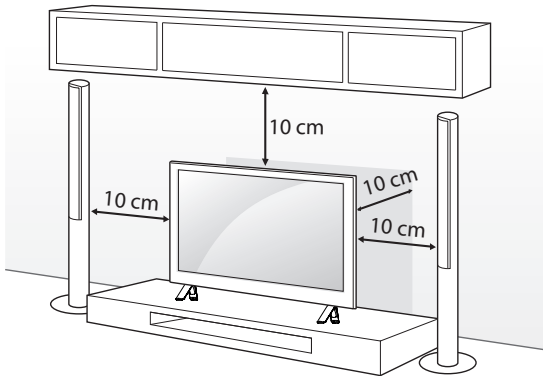

- Connect the power cord to a wall outlet.



CAUTION

- Do not place the TV near or on sources of heat, as this may result in fire or other damage.



WARNING

- If a television is not positioned in a sufficiently stable location, it can be potentially hazardous due to falling. Many injuries, particularly to children, can be avoided by taking simple precautions such as:
 - Using cabinets or stands recommended by the manufacturer of the television.
 - Only using furniture that can safely support the television.
 - Ensuring the television is not overhanging the edge of the supporting furniture.
 - Not placing the television on tall furniture (for example, cupboards or bookcases) without anchoring both the furniture and the television to a suitable support.
 - Not standing the televisions on cloth or other materials placed between the television and supporting furniture.
 - Educating children about the dangers of climbing on furniture to reach the television or its controls.

Securing the TV to a Wall

(This feature is not available for all models.)

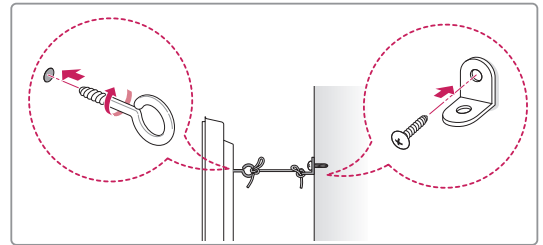
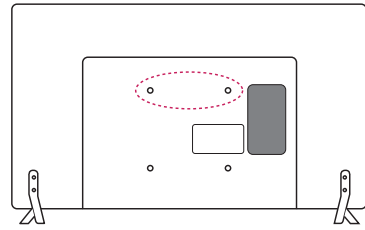

- Insert and tighten the eye-bolts, or TV brackets and bolts on the back of the TV.
 - If there are bolts inserted at the eye-bolts position, remove the bolts first.
- Mount the wall brackets with the bolts to the wall.

Match the location of the wall bracket and the eye-bolts on the rear of the TV.
- Connect the eye-bolts and wall brackets tightly with a sturdy rope.

Make sure to keep the rope horizontal with the flat surface.



CAUTION

- Make sure that children do not climb on or hang on the TV.



NOTE

- Use a platform or cabinet that is strong and large enough to support the TV securely.
- Brackets, bolts and ropes are not provided. You can obtain additional accessories from your local dealer.

Mounting on a Wall

Attach an optional wall mount bracket at the rear of the TV carefully and install the wall mount bracket on a solid wall perpendicular to the floor. When you attach the TV to other building materials, please contact qualified personnel. LG recommends that wall mounting be performed by a qualified professional installer.

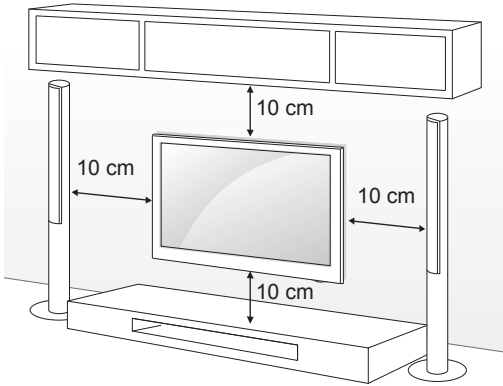

Separate Purchase(Wall Mounting Bracket)

Make sure to use screws and wall mount bracket that meet the VESA standard. Standard dimensions for the wall mount kits are described in the following table.

Model	28LY33**	32LY34** 32/39LY54**
VESA (A x B)	100 x 100	200 x 200
Standard screw	M4 X L10	M6
Number of screws	4	4
Wall mount bracket	LSW140B	LSW240B MSW240
Model	42/47/55LY54** 42/47LY34**	
VESA (A x B)	400 x 400	
Standard screw	M6	
Number of screws	4	
Wall mount bracket	LSW440B MSW240	

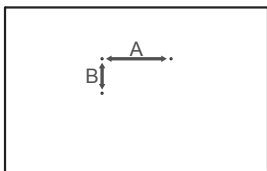

CAUTION

- Disconnect the power first, and then move or install the TV. Otherwise electric shock may occur.
- If you install the TV on a ceiling or slanted wall, it may fall and result in severe injury. Use an authorized LG wall mount and contact the local dealer or qualified personnel.
- Do not over tighten the screws as this may cause damage to the TV and void your warranty.
- Use the screws and wall mounts that meet the VESA standard. Any damages or injuries by misuse or using an improper accessory are not covered by the manufacturer's warranty.
- Screw length from outer surface of back cover should be under 8mm. (Only 28LY33**)

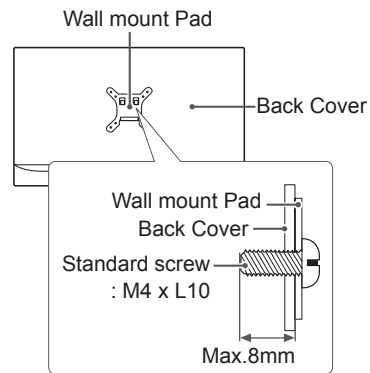

NOTE

- Use the screws that are listed on the VESA standard screw specifications.
- The wall mount kit includes an installation manual and necessary parts.
- The wall mount bracket is not provided. You can obtain additional accessories from your local dealer.
- The length of screws may differ depending on the wall mount. Make sure to use the proper length.
- For more information, refer to the manual supplied with the wall mount.

NOTE

- Only 42LY34**, 42LY54**

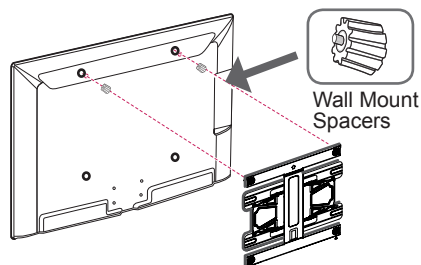

MAKING CONNECTIONS

* Image shown may differ from your TV.

* Any separate cable is not provided.

This section on **MAKING CONNECTIONS** mainly uses diagrams for the LY34** models.

Connect various external devices to the TV and switch input modes to select an external device. For more information on external device's connection, refer to the manual provided with each device.

Available external devices are: HD receivers, DVD players, VCRs, audio systems, USB storage devices, PC, gaming devices, and other external devices.

NOTE

- The external device connection may differ from the model.
- Connect external devices to the TV regardless of the order of the TV port.
- If you record a TV program on a DVD recorder or VCR, make sure to connect the TV signal input cable to the TV through a DVD recorder or VCR. For more information on recording, refer to the manual provided with the connected device.
- Refer to the external equipment's manual for operating instructions.
- If you connect a gaming device to the TV, use the cable supplied with the gaming device.
- In PC mode, there may be noise associated with the resolution, vertical pattern, contrast or brightness. If noise is present, change the PC output to another resolution, change the refresh rate to another rate or adjust the brightness and contrast on the PICTURE menu until the picture is clear.
- In PC mode, some resolution settings may not work properly depending on the graphics card.
- Only a USB storage device is recognizable.
- If the USB storage device is connected through a USB hub, the device is not recognizable.
- Using a DVI to HDMI cable may cause compatibility issues.

Antenna Connection

Connect the TV to a wall antenna socket with an RF cable (75 Ω).

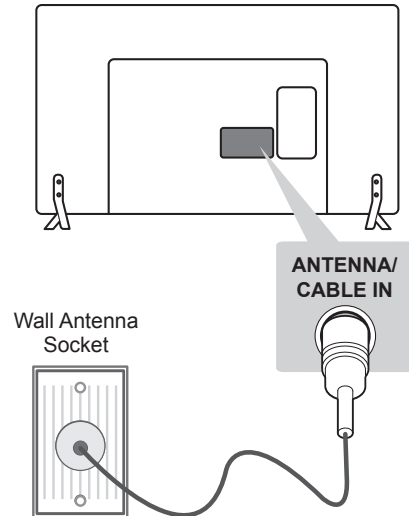

NOTE

- Use a signal splitter to use more than 2 TVs.
- If the image quality is poor, install a signal amplifier properly to improve the image quality.
- If the image quality is poor with an antenna connected, try to realign the antenna in the correct direction.
- An antenna cable and converter are not supplied.
- Supported DTV Audio: MPEG, Dolby Digital, Dolby Digital Plus, HE-AAC

Adapter Connection

(Only 28LY33**)

(Depending on model & country)

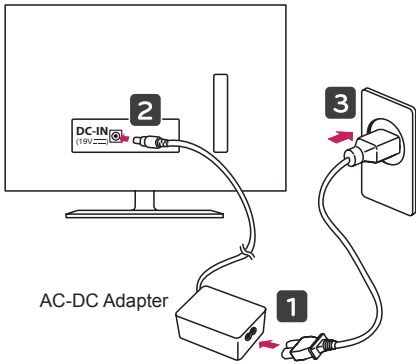

or

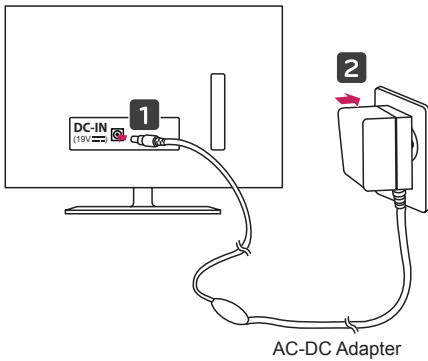

CAUTION

- Please be sure to connect the TV to the AC-DC power adapter before connecting the TV's power plug to a wall power outlet.

Network Setup

Wired Network Connection

(Only LY54**)

This TV can be connected to a local area network (LAN) via the LAN port. After making the physical connection, the TV needs to be set up for network communication.

(Image shown may differ from your TV.)

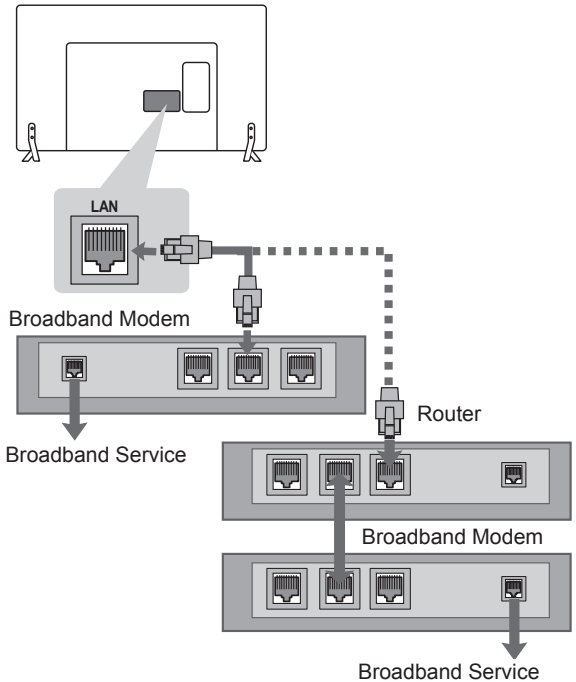

Connect the LAN port of the Modem or Router to the LAN port on the TV.

CAUTION

- Do not connect a modular phone cable to the LAN port.
- Since there are various connection methods, please follow the specifications of your telecommunication carrier or internet service provider.

Other Connections

Connect your TV to external devices. For the best picture and audio quality, connect the external device and the TV with the HDMI cable as shown.

* Image shown may differ from your TV.

* Any separate cable is not provided.

(Only 32/42/47LY34**, 32/39/42/47/55LY54**)

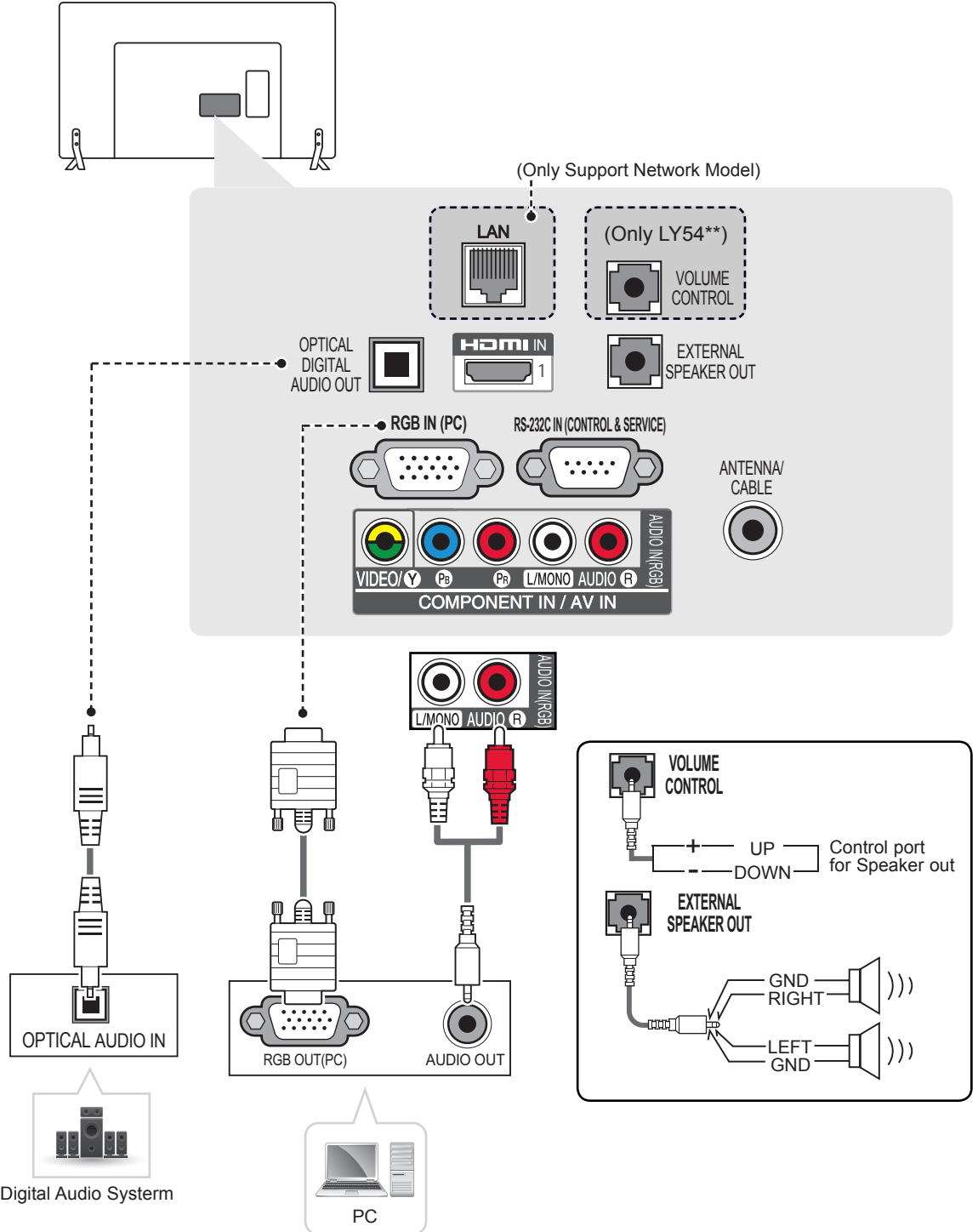

(Only 32/42/47LY34**, 32/39/42/47/55LY54**)

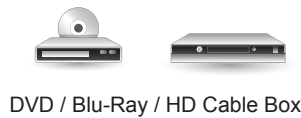
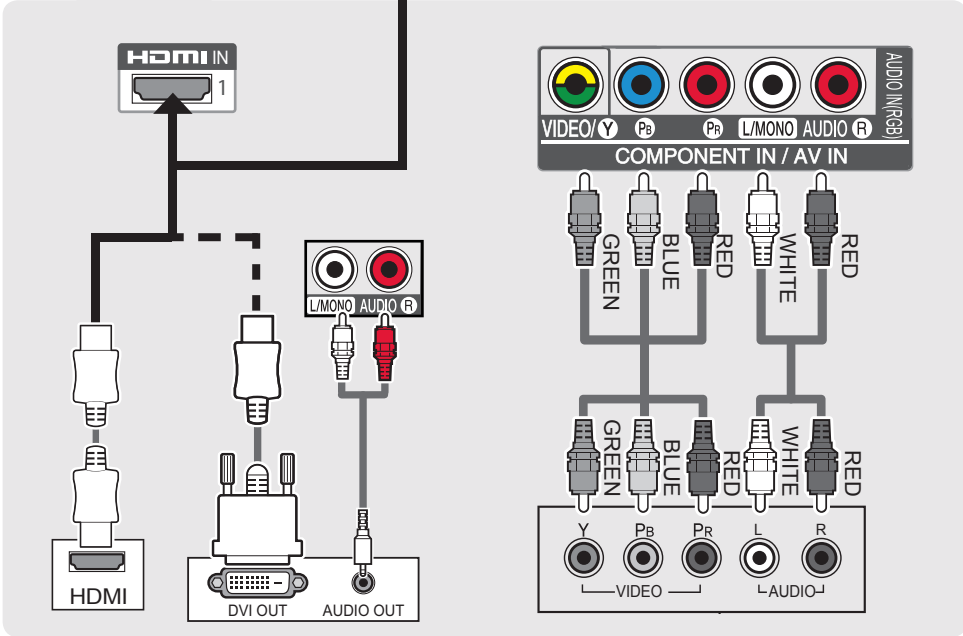
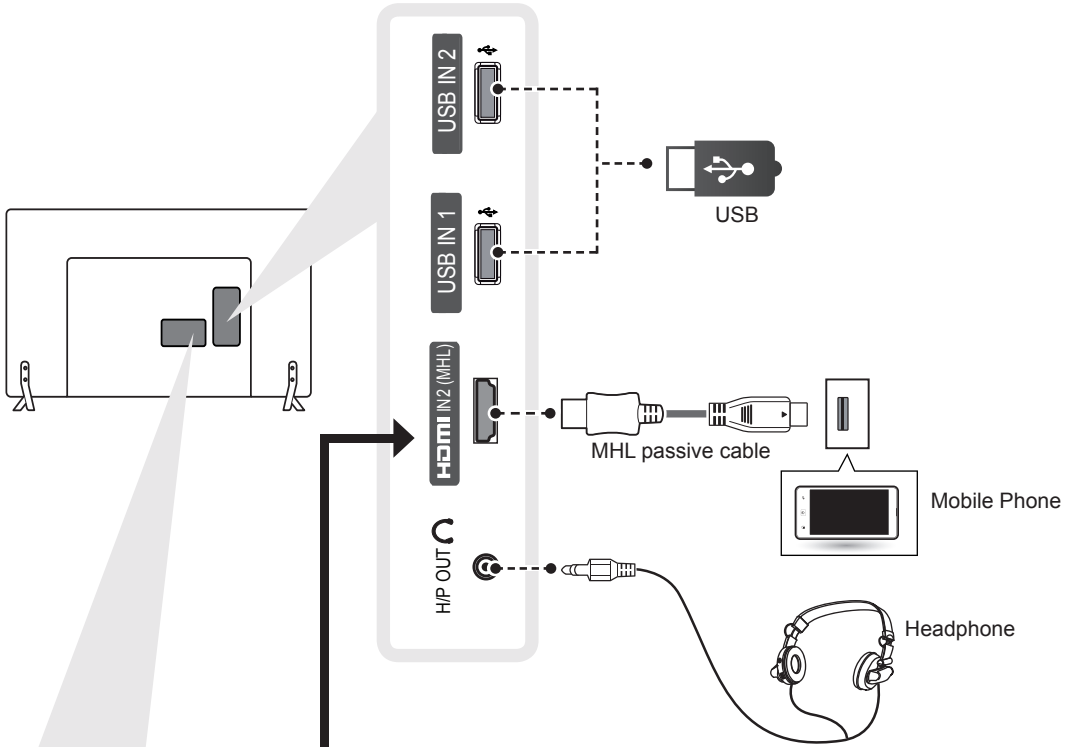

(Only 28LY33**)

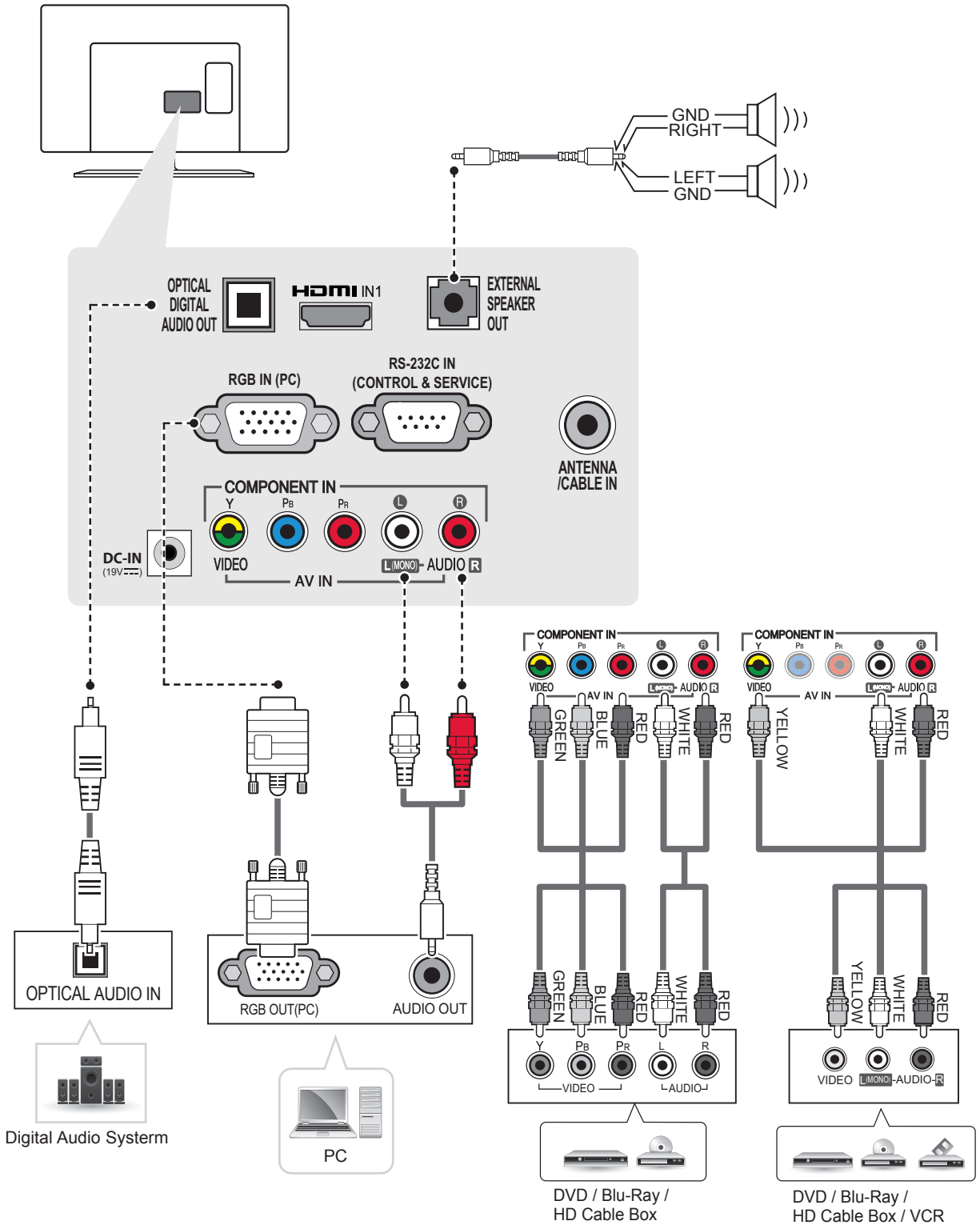

(Only 28LY33**)

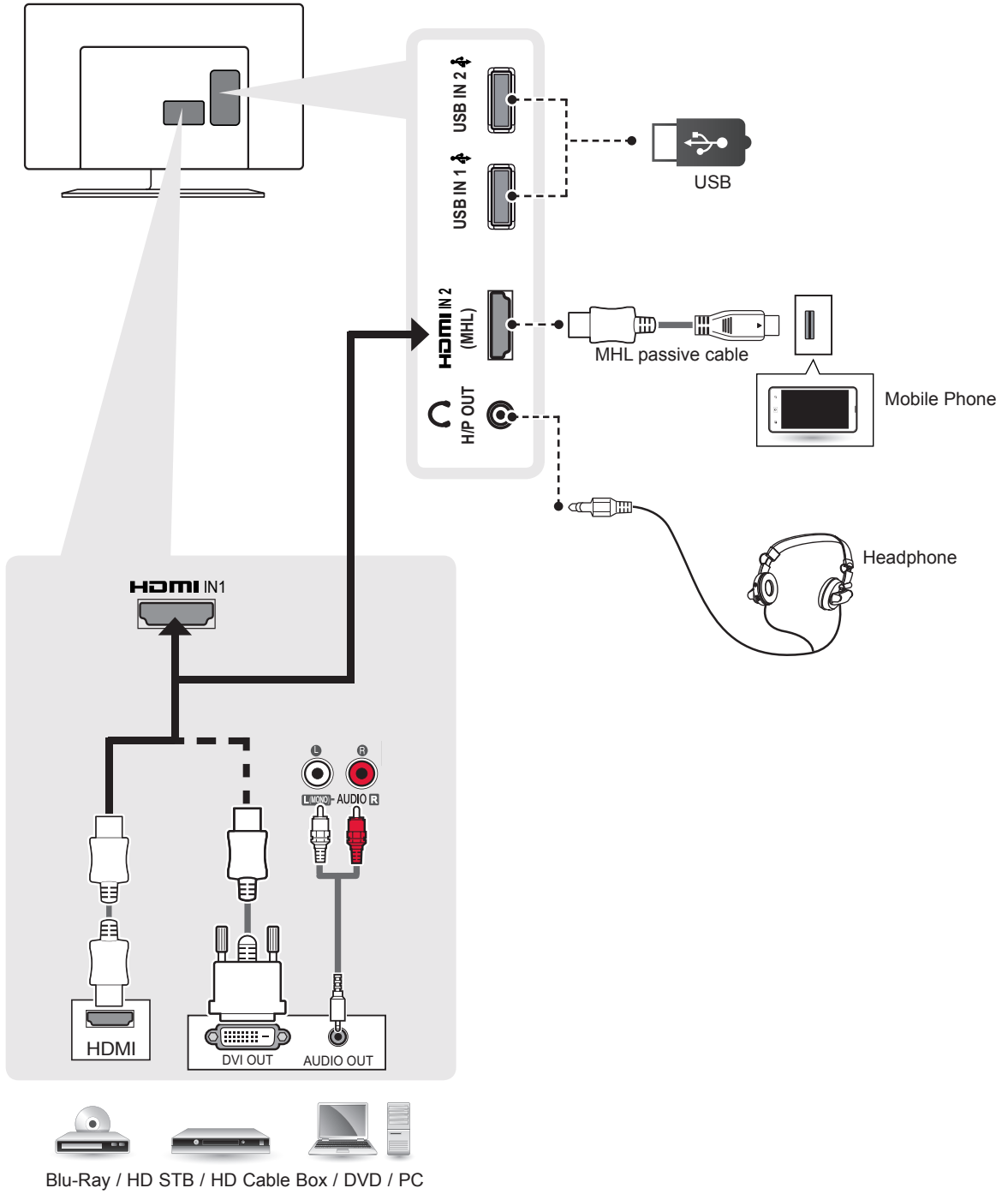

REMOTE CONTROL

The descriptions in this manual are based on the buttons on the remote control.

Please read this manual carefully and use the TV correctly.

To replace batteries, open the battery cover, replace batteries (1.5 V AAA) matching the ⊕ and ⊖ ends to the label inside the compartment, and close the battery cover.

To remove the batteries, perform the installation actions in reverse.

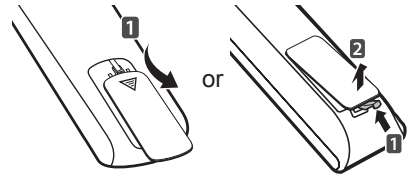

⚠ CAUTION

- Do not mix old and new batteries, as this may damage the remote control.
- In Analogue TV and some countries, some remote control buttons may not work.

Make sure to point the remote control toward the remote control sensor on the TV.

(Only LY33**, LY34**)

	<p>⏻ (POWER) Turns the TV on or off.</p> <p>TV/RAD Selects Radio, TV and DTV programme.</p> <p>SUBTITLE Recalls your preferred subtitle in digital mode.</p> <p>AV MODE Selects an AV mode.</p> <p>RATIO Resizes an image.</p> <p>INPUT Changes the input source.</p>
	<p>Number buttons Enters numbers.</p> <p>LIST Accesses the saved programme list.</p> <p>Q.VIEW Returns to the previously viewed programme.</p>
	<p>+ / - Adjusts the volume level.</p> <p>FAV Accesses your favourite programme list.</p> <p>GUIDE Shows programme guide.</p> <p>MUTE Mutes all sounds.</p> <p>^ P v Scrolls through the saved programmes or channels.</p> <p>^ PAGE v Moves to the previous or next screen.</p>
	<p>Teletext buttons (≡ TEXT/T.OPT) These buttons are used for teletext.</p> <p>INFO Views the information of the current programme and screen.</p>
	<p>SETTINGS Accesses the main menus.</p> <p>Q.MENU Accesses the quick menus.</p> <p>OK Selects menus or options and confirms your input.</p> <p>Navigation buttons (up/down/left/right) Scrolls through menus or options.</p> <p>↶ BACK Returns to the previous level.</p> <p>EXIT Clears all on-screen displays and return to TV viewing.</p>
	<p>SIMPLINK Accesses the AV devices connected with the HDMI cable through HDMI-CEC. Opens the SIMPLINK menu.</p> <p>SLEEP Sets the sleep timer.</p>
	<p>Control buttons (■, ▶, , ◀, ▶) Controls the MY MEDIA menus, or the SIMPLINK compatible devices (USB, SIMPLINK).</p>
	<p>Colour buttons These access special functions in some menus.</p> <p>(●): Red, (●): Green, (●): Yellow, (●): Blue</p>

(Only LY54**)

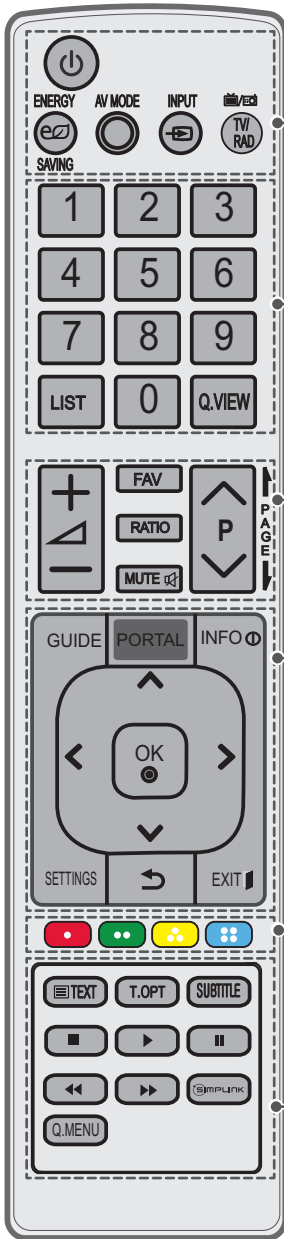

<p>⏻ (POWER) Turns the TV on or off.</p> <p>⏻ ENERGY SAVING Adjusts the brightness of the screen to reduce energy consumption.</p> <p>AV MODE Selects an AV mode.</p> <p>INPUT Changes the input source.</p> <p>TV/RAD Selects Radio, TV and DTV programme.</p>
<p>Number buttons Enters numbers.</p> <p>LIST Accesses the saved programme list.</p> <p>Q.VIEW Returns to the previously viewed programme.</p>
<p>+ / - Adjusts the volume level.</p> <p>FAV Accesses your favourite programme list.</p> <p>RATIO Resizes an image.</p> <p>MUTE Mutes all sounds.</p> <p>^ P v Scrolls through the saved programmes or channels.</p> <p>↑ PAGE ↓ Moves to the previous or next screen.</p>
<p>GUIDE Shows programme guide.</p> <p>PORTAL Displays and removes hotel interactive menu.</p> <p>INFO Views the information of the current programme and screen.</p> <p>Navigation buttons (up/down/left/right) Scrolls through menus or options.</p> <p>OK Selects menus or options and confirms your input.</p> <p>SETTINGS Selects a menu. Clears all on-screen displays and returns to TV viewing from any menu.</p> <p>↶ Returns to the previous level.</p> <p>EXIT Clears on-screen displays and return to TV viewing.</p>
<p>Colour buttons These access special functions in some menus. (●: Red, ●: Green, ●: Yellow, ●: Blue)</p>
<p>Teletext buttons (≡ TEXT/T.OPT) These buttons are used for teletext.</p> <p>SUBTITLE Recalls your preferred subtitle in digital mode.</p> <p>Control buttons (■, ▶, , ◀, ▶) Controls the MY MEDIA menus, or the SIMPLINK compatible devices (USB, SIMPLINK).</p> <p>SIMPLINK Accesses the AV devices connected with the HDMI cable through HDMI-CEC. Opens the SIMPLINK menu.</p> <p>Q.MENU Accesses the Quick menus.</p>

MAINTENANCE

Cleaning your TV

Clean your TV regularly to keep the best performance and to extend the product lifespan.



CAUTION

- Make sure to turn the power off and disconnect the power cord and all other cables first.
- When the TV is left unattended and unused for a long time, disconnect the power cord from the wall outlet to prevent possible damage from lightning or power surges.

Screen, Frame, Cabinet and Stand

- To remove dust or light dirt, wipe the surface with a dry, clean, and soft cloth.
- To remove major dirt, wipe the surface with a soft cloth dampened in clean water or a diluted mild detergent. Then wipe immediately with a dry cloth.



CAUTION

- Avoid touching the screen at all times, as this may result in damage to the screen.
- Do not push, rub, or hit the screen surface with your fingernail or a sharp object, as this may result in scratches and image distortions.
- Do not use any chemicals as this may damage the product.
- Do not spray liquid onto the surface. If water enters the TV, it may result in fire, electric shock, or malfunction.

Power Cord

Remove the accumulated dust or dirt on the power cord regularly.

TROUBLESHOOTING

The software version can be updated for improvement in performance. Customer needs to ensure the compatibility of customer's equipment with LGE software. If needed, please consult with LGE and upload revised software version according to the guidance provided by LGE.

Problem	Solution
Cannot control the TV with the remote control.	<ul style="list-style-type: none"> • Check the remote control sensor on the product and try again. • Check if there is any obstacle between the product and the remote control. • Check if the batteries are still working and properly installed (⊕ to ⊕, ⊖ to ⊖).
No image display and no sound is produced.	<ul style="list-style-type: none"> • Check if the product is turned on. • Check if the power cord is connected to a wall outlet. • Check if there is a problem in the wall outlet by connecting other products.
The TV turns off suddenly.	<ul style="list-style-type: none"> • Check the power control settings. The power supply may be interrupted. • Check if the Auto sleep feature is activated in the Time settings.
When connecting to the PC (RGB/HDMI DVI), 'No signal' or 'Invalid Format' is displayed.	<ul style="list-style-type: none"> • Turn the TV off/on using the remote control. • Reconnect the RGB/HDMI DVI cable. • Restart the PC with the TV on.

SPECIFICATIONS

Product specifications may be changed without prior notice due to upgrade of product functions.
For the power supply and power consumption, refer to the label attached to the product.

MODELS		32LY34**	42LY34**	47LY34**
		32LY340C-TA	42LY340C-TA	47LY340C-TA
Dimensions (W x H x D)	With stand (mm)	732 x 481 x 207	961 x 612 x 218	1073 x 676 x 247
	Without stand (mm)	732 x 431 x 55.5	961 x 567 x 55.5	1073 x 629 x 55.8
Weight	With stand (kg)	6.2	9.5	12.7
	Without stand (kg)	6.0	9.2	12.3
Power requirement		AC 100-240 V~ 50 / 60 Hz		
MODELS		32LY54**	39LY54**	42LY54**
		32LY540H-TA	39LY540H-TA	42LY540H-TA
Dimensions (W x H x D)	With stand (mm)	732 x 481 x 207	885 x 567 x 218	961 x 612 x 218
	Without stand (mm)	732 x 431 x 55.5	885 x 524 x 55.5	961 x 567 x 55.5
Weight	With stand (kg)	6.2	8.3	9.5
	Without stand (kg)	6.0	8.0	9.2
Power requirement		AC 100-240 V~ 50 / 60 Hz		
MODELS		47LY54**	55LY54**	28LY33**
		47LY540H-TA	55LY540H-TA	28LY330C-TA
Dimensions (W x H x D)	With stand (mm)	1073 x 676 x 247	1243 x 772 x 247	641.5 x 432 x 170
	Without stand (mm)	1073 x 629 x 55.8	1243 x 725 x 56.8	641.5 x 395.8 x 57.6
Weight	With stand (kg)	12.7	18.4	4.5
	Without stand (kg)	12.3	18.0	4.2
Power requirement		AC 100-240 V~ 50 / 60 Hz		19 V --- 2.0 A

AC/DC Adapter	Manufacturer : APD Model : DA-48F19 Manufacturer : APD Model : DA-40I19
---------------	--

Environment condition	Operating Temperature	0 °C to 40 °C
	Operating Humidity	Less than 80 %
	Storage Temperature	-20 °C to 60 °C
	Storage Humidity	Less than 85 %

	Digital TV (Depend on Country)	Analogue TV (Depend on Country)
Television System	DVB-T (*DVB-T/T2)	PAL B/B, PAL B/G, PAL D/K, PAL-I SECAM B/G, SECAM D/K NTSC-M
Programme Coverage	VHF, UHF	VHF, UHF, CATV
Maximum number of storable programmes	DVB-T& Analogue TV : 1,500	
External Antenna Impedance	75 Ω	

* : Only DVB-T2 support models.

Component Port Connecting Information

Component ports on the TV	Y	P _R	P _R
---------------------------	---	----------------	----------------

Video output ports on DVD player	Y	P _R	P _R
	Y	B-Y	R-Y
	Y	Cb	Cr
	Y	Pb	Pr

Signal	Component
480i/576i	O
480p/576p	O
720p/1080i	O
1080p	O (50 Hz / 60 Hz only)

HDMI/DTV Supported Mode

Resolution	Horizontal Frequency (kHz)	Vertical Frequency (Hz)
720 x 480	31.469	59.94
	31.5	60
720 x 576	31.25	50
1280 x 720	37.500	50
	44.96	59.94
	45	60
1920 x 1080i	33.72	59.94
	33.75	60
	28.125	50.00
1920 x 1080p	26.97	23.97
	27	24
	33.716	29.976
	33.75	30.00
	56.250	50
	67.43	59.94
	67.5	60

RGB-PC, HDMI/PC Supported Mode

Resolution	Horizontal Frequency (kHz)	Vertical Frequency (Hz)
640 x 350	31.468	70.09
720 x 400	31.469	70.08
640 x 480	31.469	59.94
800 x 600	37.879	60.31
1024 x 768	48.363	60.00
1280 x 768	47.776	59.870
1152 x 864	54.348	60.053
1360 x 768	47.712	60.015
1280 x 1024 (HDMI-PC)	63.981	60.020
1920 x 1080 (HDMI-PC)	67.50	60.00



(Except for 32LY340C, 32LY540H)

NOTE

- The optimal display resolution - 28LY33** : 1360 X 768 @60Hz
- The optimal timing in each mode is vertical frequency 60Hz.

IR CODES

- This feature is not available for all models.

Code (Hexa)	Function	Note
08	 (POWER)	Remote control Button (Power On/Off)
F0	TV/RAD	Remote control Button
39	SUBTITLE	Remote control Button
30	AV MODE	Remote control Button
79	RATIO	Remote control Button
0B	INPUT	Remote control Button
10-19	Number Key 0-9	Remote control Button
53	LIST	Remote control Button
1A	Q.VIEW	Remote control Button
02	 +	Remote control Button
03	 -	Remote control Button
1E	FAV	Remote control Button
AB	GUIDE	Remote control Button
09	MUTE	Remote control Button
00	P ^ / PAGE ^	Remote control Button
01	P ^ / PAGE ^	Remote control Button
20	TEXT	Remote control Button
21	T.OPT(T.Option)	Remote control Button
43	SETTINGS	Remote control Button
45	Q.MENU	Remote control Button
AA	INFO	Remote control Button
28	BACK 	Remote control Button
5B	EXIT	Remote control Button
44	OK	Remote control Button
40	^	Remote control Button
41	v	Remote control Button
07	<	Remote control Button
06	>	Remote control Button
72	RED	Remote control Button
71	GREEN	Remote control Button
63	YELLOW	Remote control Button
61	BLUE	Remote control Button
B1	■	Remote control Button
B0	▶	Remote control Button
BA		Remote control Button
8E	▶▶	Remote control Button
8F	◀◀	Remote control Button
7E	SIMPLINK	Remote control Button
0C	PORTAL	Remote control Button
95	ENERGY SAVING	Remote control Button
0E	SLEEP	Remote control Button

EXTERNAL CONTROL DEVICE SETUP

RS-232C Setup

Connect the RS-232C (serial port) input jack to an external control device (such as a computer or an AV control system) to control the product's functions externally. Connect the serial port of the control device to the RS-232C jack on the product back panel.

Note: RS-232C connection cables are not supplied with the product.

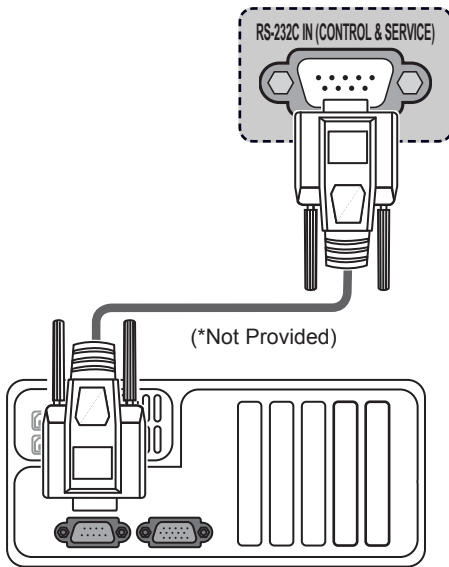

Type of Connector: D-Sub 9-Pin Male

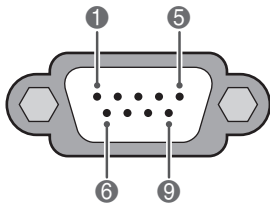

No.	Pin name
1	3.5V
2	RXD (Receive data)
3	TXD (Transmit data)
4	IR OUT from TV
5	GND
6	No Connection
7	No Connection (5V available in some models)
8	No Connection
9	No Connection (12V available in some models)

RS-232C Configurations

7-Wire Configurations (Standard RS-232C cable)

	PC	TV	
RXD	2	3	TXD
TXD	3	2	RXD
GND	5	5	GND
DTR	4	6	DSR
DSR	6	4	DTR
RTS	7	8	CTS
CTS	8	7	RTS
	D-Sub 9	D-Sub 9	

3-Wire Configurations (Not standard)

	PC	TV	
RXD	2	3	TXD
TXD	3	2	RXD
GND	5	5	GND
DTR		6	DTR
DSR	6	4	DSR
RTS	7	7	RTS
CTS	8	8	CTS
	D-Sub 9	D-Sub 9	

Set ID

Set ID number. "Real Data Mapping".

- 1 Press **SETTINGS** or **HOME** to access the main menus.
- 2 Press the Navigation buttons to scroll to **OPTION** and press **OK**.
- 3 Press the Navigation buttons to scroll to **Set ID** and press **OK**.
- 4 Scroll left or right to select a set ID number and select **Close**. The adjustment range is 1-99.
- 5 When you are finished, press **EXIT**.

Communication Parameters

- Baud rate: 9600 bps (UART)
- Data length: 8 bits
- Parity : None
- Stop bit: 1 bit
- Communication code: ASCII code
- Use a crossed (reverse) cable.

Command Reference List

(Depending on Model)

	COMMAND1	COMMAND2	DATA (Hexadecimal)		COMMAND1	COMMAND2	DATA (Hexadecimal)
01. Power	k	a	00 to 01	13. Balance	k	t	00 to 64
02. Aspect Ratio	k	c	(See p. 27)	14. Colour Temperature	x	u	00 to 64
03. Screen Mute	k	d	(See p. 27)	15. Energy Saving	j	q	00 to 05
04. Volume Mute	k	e	00 to 01	16. Auto Configuration	j	u	01
05. Volume Control	k	f	00 to 64	17. Equalize	j	v	(See p. 29)
06. Contrast	k	g	00 to 64	18. Tune Command	m	a	(See p. 29)
07. Brightness	k	h	00 to 64	19. Programme Add/Skip	m	b	00 to 01
08. Colour	k	i	00 to 64	20. Key	m	c	(See p. 29)
09. Tint	k	j	00 to 64	21. Control Back Light	m	g	00 to 64
10. Sharpness	k	k	00 to 32	22. Input select (Main)	x	b	(See p. 30)
11. OSD Select	k	l	00 to 01				
12. Remote Control Lock Mode	k	m	00 to 01				

* Note : During USB operations such as DivX or EMF, all commands except Power(ka) and Key(mc) are not executed and treated as NG.

Transmission / Receiving Protocol

Transmission

[Command1][Command2][][Set ID][][Data][Cr]

[Command 1] : First command to control the TV.(j, k, m or x)

[Command 2] : Second command to control the TV.

[Set ID] : You can adjust the set ID to choose desired monitor ID number in option menu. Adjustment range is 1 to 99. When selecting Set ID '0', every connected set is controlled.

Set ID is indicated as decimal (1 to 99) on menu and as Hexa decimal (0x0 to 0x63) on transmission/receiving protocol.

[DATA] : To transmit command data. Transmit 'FF' data to read status of command.

[Cr] : Carriage Return
ASCII code '0x0D'

[] : ASCII code 'space (0x20)'

OK Acknowledgement

[Command2][][Set ID][][OK][Data][x]

* The set transmits ACK (acknowledgement) based on this format when receiving normal data. At this time, if the data is data read mode, it indicates present status data. If the data is data write mode, it returns the data of the PC computer.

Error Acknowledgement

[Command2][][Set ID][][NG][Data][x]

* The set transmits ACK (acknowledgement) based on this format when receiving abnormal data from non-viable functions or communication errors.

Data 00: Illegal Code

01. Power (Command: k a)

- ▶ To control Power On/Off of the set.

Transmission [k][a][][Set ID][][Data][Cr]

Data 00 : Power Off 01 : Power On

Ack [a][][Set ID][][OK/NG][Data][x]

- ▶ To show Power On/Off.

Transmission [k][a][][Set ID][][FF][Cr]

Ack [a][][Set ID][][OK/NG][Data][x]

* Similarly, if other functions transmit '0xFF' data based on this format, Acknowledgement data feed back presents status about each function.

* OK Ack., Error Ack. and other message may display on the screen when TV is power On.

02. Aspect Ratio (Command: k c) (Main Picture Size)

- ▶ To adjust the screen format. (Main picture format)
You can also adjust the screen format using the Aspect Ratio in the Q.MENU. or PICTURE menu.

Transmission [k][c][][Set ID][][Data][Cr]

Data 01 : Normal screen 07 : 14:9
 (4:3) 09 : Just Scan
02 : Wide screen 0B : Full Wide
 (16:9) 10 to 1F : Cinema Zoom 1 to 16
04 : Zoom
06 : Original

Ack [c][][Set ID][][OK/NG][Data][x]

* Using the PC input, you select either 16:9 or 4:3 screen aspect ratio.

* In DTV/HDMI (1080i 50 Hz / 60 Hz, 720p 50Hz / 60 Hz, 1080p 24 Hz / 30 Hz / 50 Hz / 60 Hz), Component(720p, 1080i, 1080p 50 Hz / 60 Hz) mode, Just Scan is available.

* Full Wide is supported only for Digital, Analogue, AV.

03. Screen Mute (Command: k d)

- ▶ To select screen mute on/off.

Transmission [k][d][][Set ID][][Data][Cr]

Data 00 : Screen mute off (Picture on)
 Video mute off
01 : Screen mute on (Picture off)
10 : Video mute on

Ack [d][][Set ID][][OK/NG][Data][x]

* In case of video mute on only, TV will display On Screen Display(OSD). But, in case of Screen mute on, TV will not display OSD.

04. Volume Mute (Command: k e)

- ▶ To control volume mute on/off.
You can also adjust mute using the MUTE button on remote control.

Transmission [k][e][][Set ID][][Data][Cr]

Data 00 : Volume mute on (Volume off)
01 : Volume mute off (Volume on)

Ack [e][][Set ID][][OK/NG][Data][x]

05. Volume Control (Command: k f)

- ▶ To adjust volume.
You can also adjust volume with the volume buttons on remote control.

Transmission [k][f][][Set ID][][Data][Cr]

Data Min : 00 to Max : 64

* Refer to 'Real data mapping'. See p.30.

Ack [f][][Set ID][][OK/NG][Data][x]

06. Contrast (Command: k g)

- ▶ To adjust screen contrast.
You can also adjust contrast in the PICTURE menu.

Transmission [k][g][][Set ID][][Data][Cr]

Data Min : 00 to Max : 64

* Refer to 'Real data mapping'. See p.30.

Ack [g][][Set ID][][OK/NG][Data][x]

07. Brightness (Command: k h)

- ▶ To adjust screen brightness.
You can also adjust brightness in the PICTURE menu.

Transmission [k][h][][Set ID][][Data][Cr]

Data Min : 00 to Max : 64

* Refer to 'Real data mapping'. See p.30.

Ack [h][][Set ID][][OK/NG][Data][x]

08. Colour (Command: k i)

- ▶ To adjust the screen colour.
You can also adjust colour in the PICTURE menu.

Transmission [k][i][][Set ID][][Data][Cr]

Data Min : 00 to Max : 64

* Refer to 'Real data mapping'. See p.30.

Ack [i][][Set ID][][OK/NG][Data][x]

09. Tint (Command: k j)

- ▶ To adjust the screen tint.
You can also adjust tint in the PICTURE menu.

Transmission [k][j][][Set ID][][Data][Cr]

Data Red : 00 to Green : 64

* Refer to 'Real data mapping'. See p.30.

Ack [j][][Set ID][][OK/NG][Data][x]

10. Sharpness (Command: k k)

- ▶ To adjust the screen sharpness.
You can also adjust sharpness in the PICTURE menu.

Transmission [k][k][][Set ID][][Data][Cr]

Data Min : 00 to Max : 32

* Refer to 'Real data mapping'. See p.30.

Ack [k][][Set ID][][OK/NG][Data][x]

11. OSD Select (Command: k l)

- ▶ To select OSD (On Screen Display) on/off when controlling remotely.

Transmission [k][l][][Set ID][][Data][Cr]

Data 00 : OSD off 01 : OSD on

Ack [l][][Set ID][][OK/NG][Data][x]

12. Remote control lock mode (Command: k m)

- ▶ To lock the front panel controls on the monitor and remote control.

Transmission [k][m][][Set ID][][Data][Cr]

Data 00 : Lock off 01 : Lock on

Ack [m][][Set ID][][OK/NG][Data][x]

* If you are not using the remote control, use this mode.

When main power is on/off, external control lock is released.

* In the standby mode, if key lock is on, TV will not turn on by power on key of IR & Local Key.

13. Balance (Command: k t)

- ▶ To adjust balance.
You can also adjust balance in the AUDIO menu.

Transmission [k][t][][Set ID][][Data][Cr]

Data Min : 00 to Max : 64

* Refer to 'Real data mapping'. See p.30.

Ack [t][][Set ID][][OK/NG][Data][x]

14. Colour Temperature (Command: x u)

- ▶ To adjust colour temperature. You can also adjust Colour Temperature in the PICTURE menu.

Transmission [x][u][][Set ID][][Data][Cr]

Data Min : 00 to Max : 64

* Refer to 'Real data mapping'. See p.30.

Ack [u][][Set ID][][OK/NG][Data][x]

15. Energy Saving (Command: j q)

- ▶ To reduce the power consumption of the TV. You can also adjust Energy Saving in PICTURE menu.

Transmission [j][q][][Set ID][][Data][Cr]

Power Saving Function					Level				Description
7	6	5	4		3	2	1	0	
0	0	0	0	Low Power	0	0	0	0	Off
0	0	0	0	Low Power	0	0	0	1	Minimum
0	0	0	0	Low Power	0	0	1	0	Medium
0	0	0	0	Low Power	0	0	1	1	Maximum
0	0	0	0	Low Power	0	1	0	1	Screen Off
0	0	0	0	Low Power	0	1	0	0	Auto

- ▶ 'Auto' is available in TV that supports 'Intelligent Sensor'

Ack [q][][Set ID][][OK/NG][Data][x]

16. Auto Configure(Command: j u) (Only RGB support model)

- ▶ To adjust picture position and minimize image shaking automatically. It works only in RGB (PC) mode.

Transmission [j][u][][Set ID][][Data][Cr]

Data 01: To set

Ack [u][][Set ID][][OK/NG][Data][x]

17. Equalize(Command: j v)

- ▶ To adjust equalize.

Transmission [j][v][][Set ID][][Data][Cr]

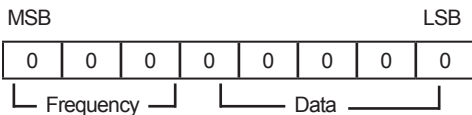

7	6	5	Frequency	4	3	2	1	0	Step
0	0	0	1'st Band	0	0	0	0	0	0(decimal)
0	0	1	2'nd Band	0	0	0	0	1	1(decimal)
0	1	0	3'rd Band
0	1	1	4'th Band	1	0	0	1	1	19(decimal)
1	0	0	5'th Band	1	0	1	0	0	20(decimal)

Ack [v][][Set ID][][OK/NG][Data][x]

18. Tune Command (Command: m a)

- ▶ Select channel to following physical number.

Transmission [m][a][][Set ID][][Data0][][Data1][][Data2][Cr]

Data00 : High channel data

Data01 : Low channel data

- ex. No. 47 -> 00 2F (2FH)
No. 394 -> 01 8A (18AH),
DTV No. 0 -> Don't care

Data02 : [Antena]

0x00 : Analog Main

0x10 : DTV Main

0x20 : Radio

[Cable]

0x80 : Analog Main

0x90 : DTV Main

0xA0 : Radio

Channel data range

Analogue - Min: 00 to Max: 63 (0 to 99)

Digital - Min: 00 to Max: 3E7 (0 to 999)

Ack [a][][Set ID][][OK/NG][Data][x]

Data Min: 00 to Max: 7DH

19. Programme Add/Skip(Command: m b)

- ▶ To set skip status for the current Programme.

Transmission [m][b][][Set ID][][Data][Cr]

Data 00 : Skip 01 : Add

Ack [b][][Set ID][][OK/NG][Data][x]

20. Key(Command: m c)

- ▶ To send IR remote key code.

Transmission [m][c][][Set ID][][Data][Cr]

Data Key code - See p. 23.

Ack [c][][Set ID][][OK/NG][Data][x]

21. Control Back Light(Command: m g)

- ▶ To control the back light.

Transmission [m][g][][Set ID][][Data][Cr]

Data Min : 00 to Max : 64

Ack [g][][Set ID][][OK/NG][Data][x]

22. Input select (Command: x b)

(Main Picture Input)

► To select input source for main picture.

Transmission [x][b][][Set ID][][Data][Cr]

Data Structure

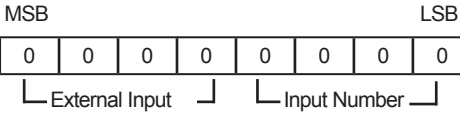

External Input				Data
0	0	0	0	DTV
0	0	0	1	Analogue
0	0	1	0	AV
0	1	0	0	Component
0	1	1	0	RGB
0	1	1	1	HDMI
1	0	0	0	
1	0	0	1	
1	0	1	0	

Input Number				Data
0	0	0	0	Input1
0	0	0	1	Input2
0	0	1	0	Input3
0	0	1	1	Input4

Ack [b][][Set ID][][OK/NG][Data][x]

*** Real data mapping**

- 00 : Step 0
- ⋮
- A : Step 10 (Set ID 10)
- ⋮
- F : Step 15 (Set ID 15)
- 10 : Step 16 (Set ID 16)
- ⋮
- 64 : Step 100
- ⋮
- 6E : Step 110
- ⋮
- 73 : Step 115
- 74 : Step 116
- ⋮
- CF : Step 199
- ⋮
- FE : Step 254
- FF : Step 255



Record the model number and serial number of the TV.
Refer to the label on the back cover and quote this information to your dealer when requiring any service.

MODEL _____

SERIAL _____

(Only DTV)

