

## OWNER'S MANUAL

# AIR CONDITIONER

Please read this manual carefully before operating your set and retain it for future reference.

TYPE : WALL MOUNTED INVERTER

### MODELS

Indoor Unit

A12NRK<sup>NSB</sup> / A12NWK<sup>NSB</sup>

A09NRK<sup>NSB</sup> / A09NWK<sup>NSB</sup>

Outdoor Unit

D12NAK<sup>UL2</sup> / D09NAK<sup>UL2</sup>



P/NO : MFL67657214

## TIPS FOR SAVING ENERGY

Here are some tips that will help you minimize the power consumption when you use the air conditioner. You can use your air conditioner more efficiently by referring to the instructions below:

- Do not set room temperature value too low. This may be harmful for your health and result in excessive power consumption.
- Limit the possibility of direct sunlight and solar heat from entering the conditioned area. Example, pull closed all drapes and blinds.
- Close all doors and windows to prevent conditioned air from leaving room and unconditioned air from entering room.
- Adjust the direction of the air flow vertically or horizontally to circulate indoor air.
- By initially setting, fan speed to high will assist with rapid room temperature control.
- Open windows regularly for ventilation as the indoor air quality may deteriorate if the air conditioner is used for many hours.
- Clean the indoor air filters every 2 weeks. Failure to remove foreign matter from filter will result in poor performance, inefficient and reduce the potential life expectancy of the product, possibly void manufacturer's warranty.

### For your records

Staple your receipt to this page in case you need it to prove the date of purchase or for warranty purposes. Write the model number and the serial number here:

Model number : \_\_\_\_\_

Serial number : \_\_\_\_\_

You can find them on a label on the side of each unit.

Dealer's name : \_\_\_\_\_

Date of purchase : \_\_\_\_\_

Installer's name : \_\_\_\_\_

Trade licence number : \_\_\_\_\_

Refrigerant handling licence Number : \_\_\_\_\_

# IMPORTANT SAFETY INSTRUCTIONS

## **READ ALL INSTRUCTIONS BEFORE USING THE APPLIANCE.**

Always comply with the following precautions to avoid dangerous situations and ensure peak performance of your product.

### **WARNING**

It can result in serious injury or death when the directions are ignored.

### **CAUTION**

It can result in minor injury or product damage when the directions are ignored.

### **WARNING**

- Installation or repairs made by unqualified persons can result in hazards to you and others.
- Air conditioner Shall be installed in accordance with national wiring regulations.
- If the supply cord is damaged, it must be replaced by the manufacturer, its service agent or similarly qualified persons in order to avoid a hazard.
- The information contained in the manual is intended for use by a qualified service technician familiar with safety procedures and equipped with the proper tools and test instruments.
- Failure to carefully read and follow all instructions in this manual can result in equipment malfunction, property damage, personal injury and/or death.
- This appliance is not intended for use by persons (including children) with reduced physical, sensory or mental capabilities, or lack of experience and knowledge, unless they have been given supervision or instruction concerning use of the appliance by a person responsible for their safety.
- Children should be supervised to ensure that they do not play with the appliance.
- When the power cord is to be replaced, replacement work shall be performed by authorized personnel only using only genuine replacement parts.

## **Installation**

- Use a standard circuit breaker and fuse conforming with the rating of the air conditioner. Failure to do so may result in electric shock or product failure.
- Contact an authorized service center when you install or relocate the air conditioner. Failure to do so may result in serious injury or product failure.
- Always use a power plug and socket with a ground terminal. Failure to do so may result in electric shock or product failure
- Install the panel and the cover of the control box safely. Failure to do so may result in explosion or fire.
- Install a dedicated electric outlet and circuit breaker before you use the air conditioner. Failure to do so may result in electric shock or product failure.
- Use a standard circuit breaker and fuse conforming with the rating of the air conditioner. Failure to do so may result in electric shock or product failure.
- Do not modify or extend the power cable. If the power cable or cord has scratches or skin peeled off or deteriorated then it must be replaced. It may result in fire or electric shock.
- Be cautious when you unpack or install the air conditioner. Failure to do so may result in serious injury or product failure.
- Contact an authorized service center when you install or relocate the air conditioner. Failure to do so may result in serious injury or product failure.
- Do not install the air conditioner on an unstable surface or where there may be a danger of it falling. It may result in death, serious injury, or product failure.

### Operation

- Do not let the air conditioner run for a long time when the humidity is very high or when a door or window has been left open. Failure to do so may result in product failure.
- Make sure that the power cord is not pulled or damaged while the air conditioner is operating. Failure to do so may result in fire, electric shock, or product failure.
- Do not place any objects on the power cord. It may result in electric shock or product failure.
- Do not turn on or off the air conditioner by plugging in or unplugging the power plug. It may result in fire or electric shock.
- Do not touch, operate or repair the air conditioner with wet hands. It may result in electric shock or product failure.
- Do not place a heater or other heating appliances near the power cable. It may result in fire, electric shock, or product failure.
- Do not allow water to run into the air conditioner. It may result in explosion or fire.
- Do not leave flammable substances such as gasoline, benzene and thinner near the air conditioner. It may result in explosion or fire.
- Do not use the air conditioner for an extended period of time in a small place without ventilation. Ventilate the place regularly. Failure to do so may result in explosion or fire.
- When there is a gas leak, ventilate sufficiently before using the air conditioner again. Failure to do so may result in explosion or fire.
- Unplug the power plug if there is a noise, smell or smoke coming from the air conditioner. Failure to do so may result in explosion or fire.
- Stop operating and close the window in storm or hurricane. If possible remove the product from the window before hurricane arrives
- Do not touch the electrostatic filter after opening the front grille. Failure to do so may result in electric shock or product failure.
- Contact an authorized service center when the air conditioner is submerged into water due to flooding. Failure to do so may result in explosion or fire.
- Be cautious water could not enter the product
- Make sure to ventilate sufficiently when this air conditioner and a heating appliance such as a heater are used simultaneously. Failure to do so may result in fire, serious injury, or product failure.
- Turn the main power off and unplug the power plug when you clean or repair the air conditioner. Failure to do so may result in death, serious injury, or product failure.
- Unplug the power plug when the air conditioner is not used for an extended period of time. Failure to do so may result in product failure.
- Do not place any objects on the air conditioner. It may result in product failure.
- For inner cleaning, contact an Authorized Service Center or a dealer.  
Do not use harsh detergent that causes corrosion or damage on the unit.  
Harsh detergent may also cause failure of product, fire, or electronic shock.

## CAUTION

### Installation

- Make sure to check if there is a refrigerant leak after you install or repair the air conditioner. Failure to do so may result in product failure.
- Install the drain hose properly for smooth drainage of condensed water. Failure to do so may result in product failure.
- Keep level even when installing the product.
- Install the air conditioner where the noise from the outdoor unit or the exhaust gas will not inconvenience the neighbors. Failure to do so may result in conflict between neighbors.
- When transporting the equipment, there should be at least 2 or more people, or a forklift. It may result in serious injury.
- Do not install the air conditioner where it will be exposed to sea wind (salt spray) directly. It may result in product failure.

### Operation

- Do not expose people, animals or plants to the cold or hot wind from the air conditioner. It may result in serious injury.
- Do not use the product for special purposes, such as preserving foods, works of art, etc. It is a consumer air conditioner, not a precision refrigeration system. It may result in death, fire or electric shock.
- Do not block the inlet or outlet of air flow. It may result in explosion or product failure.
- Do not use strong cleaning agents or solvents when you clean the air conditioner, or spray water. Use a smooth cloth. It may result in serious injury or product failure.
- Never touch the metal parts of the air conditioner when you remove the air filter. It may result in serious injury or product failure.
- Do not place any objects on the air conditioner. It may result in product failure.
- Always insert the filter securely after cleaning. Clean the filter every two weeks or more often if necessary.
- Do not insert hands or other objects through the air inlet or outlet while the air conditioner is operating. It may result in electric shock.
- Do not drink the water drained from the air conditioner. It may result in serious health complications.
- Use a sturdy stool or ladder when you clean, maintain or repair the air conditioner at a height. Failure to do so may result in serious injury or product failure.
- Do not mix the batteries for the remote control with other types of batteries or mix new batteries with used batteries. Failure to do so may result in product failure.
- Do not recharge or disassemble the batteries. Failure to do so may result in explosion, fire or serious injury.
- Stop using the remote control if there is a battery fluid leak. If your cloth or skin is exposed to the battery fluid from a leak, wash it off with clean water. Failure to do so may result in serious injury.
- If you swallow the battery fluid from a leak, wash out the inside of your mouth thoroughly and then consult a doctor. Failure to do so may result in serious health complications.

## Operation ranges

The table below indicates the temperature ranges the air conditioner can be Operated within.

Mode	Indoor temperature	Outdoor temperature
Cooling	18°C ~ 32°C	-10°C ~ 48°C
Heating	9°C ~ 30°C	-20°C ~ 24°C

## TABLE OF CONTENTS

### 2 TIPS FOR SAVING ENERGY

---

### 3 IMPORTANT SAFETY INSTRUCTIONS

---

5 Operation ranges

### 7 BEFORE USE

---

7 Components

8 Using the remote control

### 10 BASIC FUNCTIONS

---

10 Cooling your room(Cooling operation)

10 Heating your room(Heating operation)

11 Removing humidity

11 Airing your room

12 Adjusting the fan speed

12 Adjusting the air flow direction

12 Setting the timer

### 14 ADVANCED FUNCTIONS

---

14 Changing room temperature quickly (Jet Cool/Heat operation)

14 Indoor air purification

15 Purification operation

15 Energy saving cooling mode

16 LH(Low heating)

16 °C/°F Conversion

16 Display screen brightness

16 Operating the air conditioner without the remote control

17 Restarting the air conditioner automatically

### 18 MAINTENANCE

---

20 Cleaning the air filter

20 Cleaning the 3M Filter

### 21 TROUBLESHOOTING

---

21 Self-diagnosis function

21 Before requesting service

# BEFORE USE

## Components

### Indoor unit

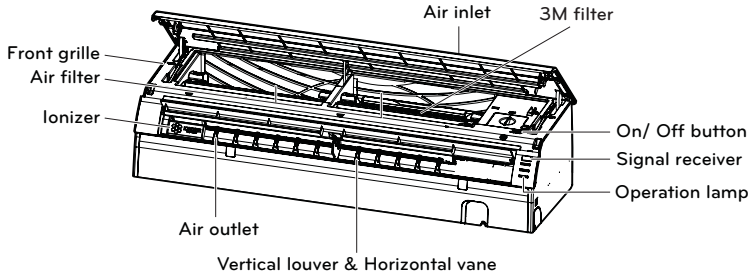

\* The Feature can change according to the model type.

### ! NOTE

- The number of operation lamps and their locations may vary, depending on the model of the air conditioner.

### Outdoor unit

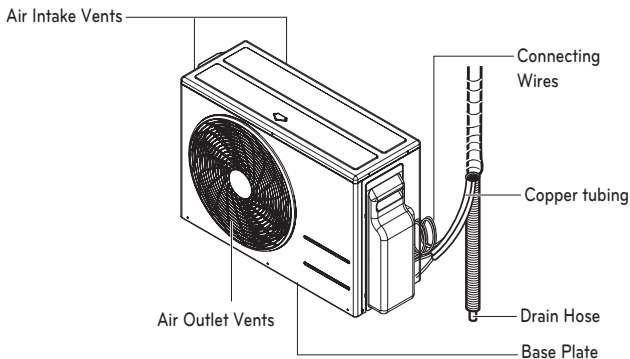

\* The Feature can change according to the model type.

## Using the remote control

You can operate the air conditioner more conveniently with the remote control. You will find the buttons for the additional functions below the down of the display screen.

### Wireless remote control

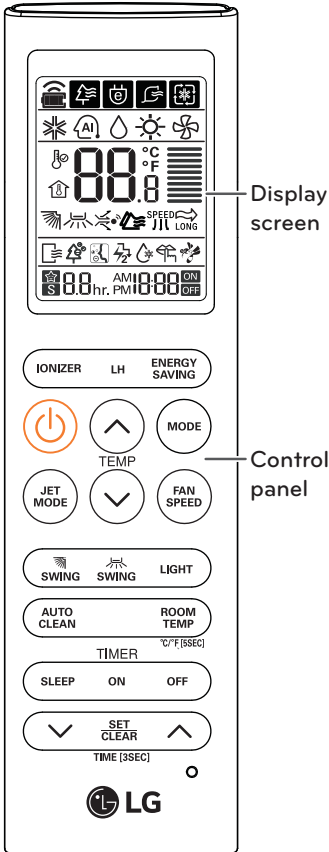

Control panel	Display screen	Description
		<b>IONIZER button*</b> : Ionizer sterilize the aerial bacteria and other harmful substances.
		<b>Sleep mode auto button*</b> : Sets the sleep mode auto operation.
		<b>Temperature adjustment buttons</b> : Adjusts the room temperature when cooling and heating.
	-	<b>On/Off button</b> : Turns the power on/off.
		<b>Indoor fan speed button</b> : Adjusts the fan speed.
		<b>Operation mode selection button*</b> : Selects the operation mode. Cooling operation (❄️) / Dehumidifying operation (💧) / Heating operation (🔥) / Air circulation (🌀)
		<b>Jet cooling/heating button*</b> : Warms up or cools down the indoor temperature within a short period of time.
		<b>Air flow direction button</b> : Adjusts the air flow direction vertically or horizontally.
		<b>Temperature display button</b> : Displays the room temperature. Also changes unit from °C to °F if pressed for 5 seconds.
		<b>Timer button</b> : Sets the current time and the start / end time.
		<b>Navigation and functions button*</b> : Adjusts the time and sets the special functions. 🏠 : Operates Energy saving cooling / 🧼 : Auto clean. LH : Maintains a minimum indoor temperature.
	-	Adjusts the brightness of the indoor unit display
	-	<b>Set/clear button</b> : Sets or cancels functions.
	-	<b>Reset button</b> : Resets the air conditioner settings.

\* Some functions may not be supported, depending on the model.



## Inserting batteries

Insert batteries before using the remote control. The battery type used is AAA (1.5 V).

- 1 Remove the battery cover.

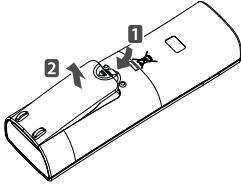

- 2 Insert the new batteries and make sure that the + and - terminals of the batteries are installed correctly.

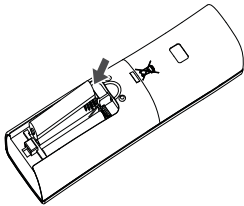

- 3 Reattach the battery cover.

### ! NOTE

- If the display screen of the remote control starts to fade, replace the batteries.

## Installing the remote control holder

Install the holder where there is no direct sunlight to protect the remote control.

- 1 Choose a safe and easily-accessible place.

- 2 Fix the holder by fastening the 2 screws firmly with a screwdriver or using adhered double-sided adhesive tape.

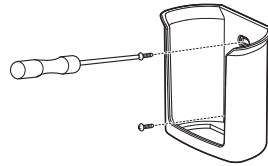

- 3 Slide the remote control into the holder.

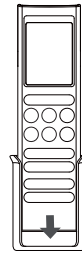

## Operating method

Point the remote control towards the signal receiver at the bottom of the air conditioner to operate it.

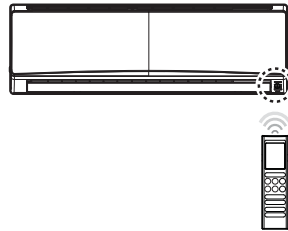





### ! NOTE

- The remote control may operate other electronic devices if pointed towards them. Make sure to point the remote control towards the signal receiver of the air conditioner.
- For proper operation, use a soft cloth to clean the signal transmitter and receiver.



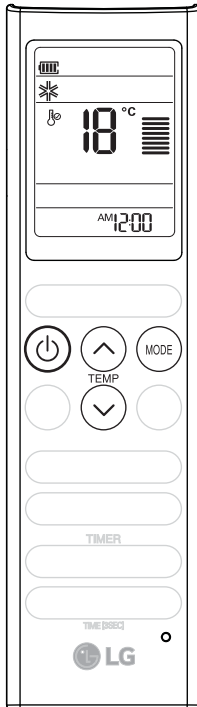

# BASIC FUNCTIONS

## Cooling your room (Cooling operation)

- 1 Press  to turn on the power.
- 2 Press  repeatedly to select the cooling operation.  
- ❄️ is displayed on the display screen.
- 3 Press  or  to set the desired temperature.  
- The temperature range is 18°C (64°F)-30°C (86°F).



## Heating your room (Heating operation)

- 1 Press  to turn on the power.
- 2 Press  repeatedly to select the heating operation.  
- ☀️ is displayed on the display screen.
- 3 Press  or  to set the desired temperature.  
- The temperature range is 16°C (60°F)-30°C (86°F).

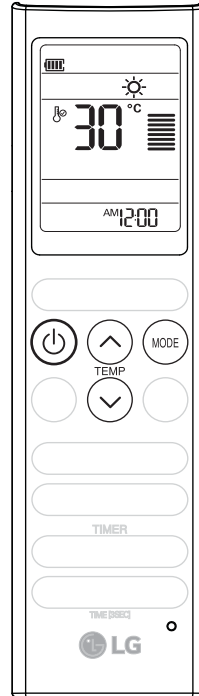



### ! NOTE

Cooling-only models do not support this function.

## Removing humidity (Dehumidifying operation)



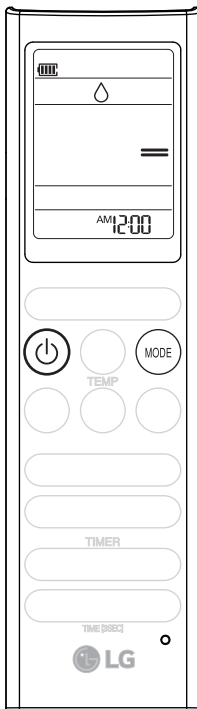

This mode removes excess moisture from an environment with high humidity or in the rainy season, in order to prevent mold from setting in. This mode adjusts the room temperature and the fan speed automatically to maintain the optimal level of humidity.

- 1 Press  to turn on the power.
- 2 Press  repeatedly to select the dehumidifying operation.  
-  is displayed on the display screen.



## Airing your room (Air Circulation operation)

This mode only circulates the indoor air without changing the room temperature. The cooling lamp lights up in air circulation mode.

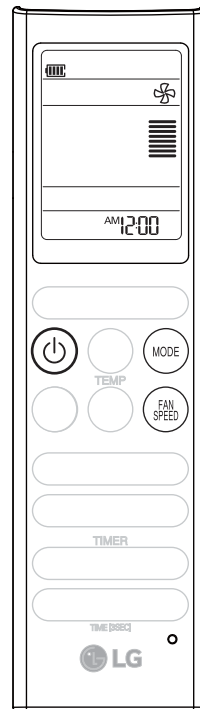

- 1 Press  to turn on the power.
- 2 Press  repeatedly to select the air circulation operation.  
-  is displayed on the display screen.
- 3 Press  to adjust the fan speed.









### ! NOTE





- In this mode you cannot adjust the desired temperature, as it is adjusted automatically. Also, the desired temperature is not displayed on the display screen.

## Adjusting the fan speed



- Press  repeatedly to adjust the fan speed.
  - Select  if you want natural air. The fan speed adjusts automatically.

Remark	Speed
	High
	Medium-High
	Medium
	Medium-Low
	Low
	Natural Wind

## Adjusting the air flow direction

- To adjust the direction of the air flow horizontally, press  repeatedly and select the desired direction.
  - Select  to adjust the direction of the air flow automatically.
- To adjust the direction of the air flow vertically, press  repeatedly and select the desired direction.
  - Select  to adjust the direction of the air flow automatically.

### NOTE

- Adjusting the air flow direction vertically may not be supported, depending on the model.
- Adjusting the air deflector arbitrarily may cause product failure.
- If you restart the air conditioner, it starts to operate with the previously set direction of air flow, so the air deflector may not match the icon displayed on the remote control. When this occurs, press  or  to adjust the direction of the air flow again.



## Setting the timer

You can use the timer function to save energy and to use the air conditioner more efficiently.

### Setting the current time

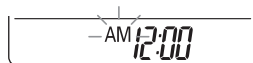
- Press  and hold it for longer than 3 seconds.
  - The AM/PM icon flickers at the bottom of the display screen.



- Press  or  to select the times.
- Press  to finish.

### Turning on the air conditioner automatically at a set time

- Press .
  - The icon below flickers at the bottom of the display screen.

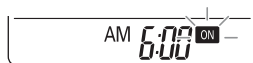

- Press  or  to select the times.
- Press  to finish.

## Turning off the air conditioner automatically at a set time

- 1 Press **OFF**.  
- The icon below flickers at the bottom of the display screen.

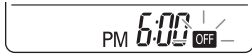

- 2 Press **∨** or **∧** to select the times.
- 3 Press **SET CLEAR** to finish.

## Canceling the timer setting

- 1 Press **ON** or **OFF** to select the timer setting to cancel.
- 2 Press **SET CLEAR**.  
- To cancel all timer settings, press **SET CLEAR**.

## Setting sleep mode

Use the sleep mode to turn off the air conditioner automatically when you go to sleep.

- 1 Press **⏻** to turn on the power.
- 2 Press **SLEEP**.
- 3 Press **∨** or **∧** to select the hour (up to 7 hours).
- 4 Press **SET CLEAR** to finish.  
- **☆** is displayed on the display screen in sleep mode.

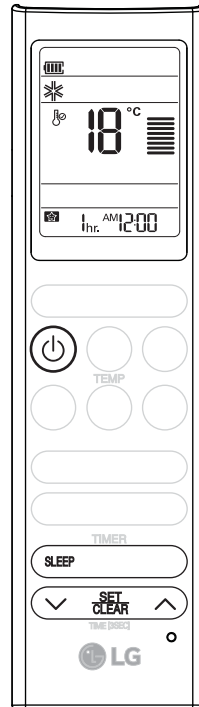

### ! NOTE



- In the Cooling and Dehumidifying modes, the temperature increases by 1°C after 30 minutes and by a further 1°C after another 30 minutes for a more comfortable sleep.
- The temperature increases with up to 2°C from the preset temperature.
- Fan speed can't be changed in case of sleep mode. Super low fan speed is set up at cooling and low fan speed is set up at heating.

## ADVANCED FUNCTIONS

The air conditioner offers some additional advanced functions.

### Changing room temperature quickly (Jet Cool/Heat operation)

This mode allows you to cool indoor air quickly in summer or warm it quickly in winter.

- 1 Press  to turn on the power.
- 2 Press .
  - In jet cooling mode, strong air blows out at a temperature of 18°C for 30 minutes.
  - In jet heating mode, strong air blows out at a temperature of 30°C for 30 minutes.

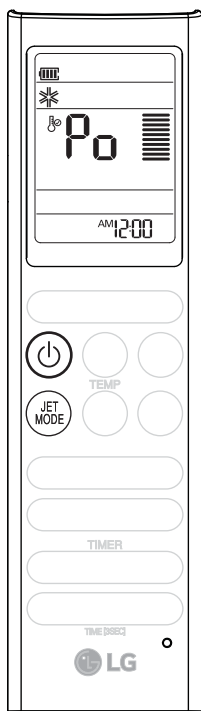



#### NOTE

- In Air Circulation, this function cannot be used.
- This function may not be supported, depending on the model.

## Indoor air purification

### Auto Cleaning

In the cooling and dehumidifying operations, moisture is generated inside the indoor unit. Use the auto cleaning function to remove such moisture.

- 1 Press  to turn on the power.
- 2 Press .
  -  is displayed on the display screen.
  - If you turn off the power, the fan operates for 30 minutes and the vane is almost closed. The 3M filter and Ionizer also operate to purify and sterilize inside of the indoor unit during auto clean operation.

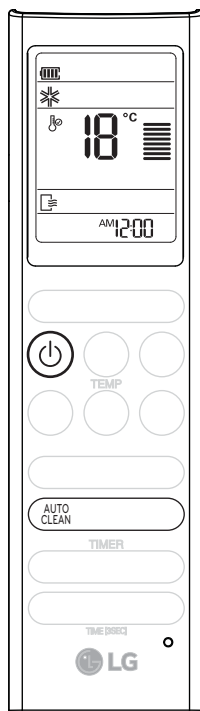



#### NOTE

Some buttons cannot be used while the auto cleaning function is in operation.

## Purification operation



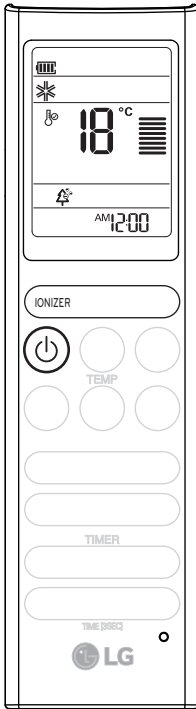

Ion particles from Ionizer developed by LG sterilize the aerial bacteria and other harmful substances.

- 1 Press  to turn on the power.
- 2 Press .
  -  is displayed on the display screen.



## Energy saving cooling mode

This mode minimizes power consumption during cooling and increases the set temperature to the optimal level for a more comfortable environment.

- 1 Press  to turn on the power.
- 2 Press  repeatedly to select the cooling operation.
- 3 Press .
  -  is displayed on the display screen.

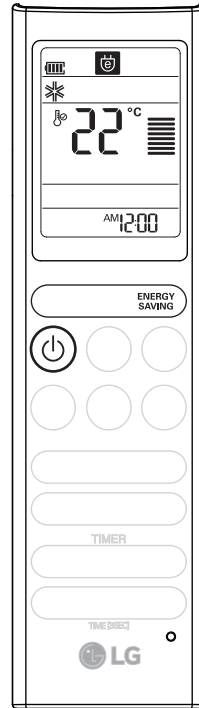

### NOTE

- You can use this function by pressing  without turning the air conditioner on.
- This function may not be supported, depending on the model.
- Do not touch Plasmaster ionizer during operation.

### NOTE



- During Energy Saving Cooling mode, temperature shown at the unit display may be different with the one shown at remote control.

### NOTE

- Possible, Different temperature is displayed on between remote controller and air conditioner during operation.

## LH(Low heating)

The operation of the heating system to maintain a minimum indoor temperature and prevent indoor objects from freezing in a situation where there is no permanent resident, such as vacation home.

- 1 Press  to turn on the power.
  - 2 Press  repeatedly to select the heating operation.
  - 3 Press .
- LH is displayed on the display screen.



### ! NOTE

- LH Key may be input only in heating operation mode (cannot input when it is off)
- When LH function is set, maintain operation mode and previous temperature(Fan speed : high), and display desired temperature display as "LH". (LH = Low heating)
- During LH operation, when LH, temperature change, wind strength, operation selection, or wind only Key is input, return to [heating / previous temperature / previous wind amount].
- If Jet Key is pressed during LH operation, end LH function and immediately execute power heating. (only for power heating model)
- In case an error occurred, operation can be interrupted for the protection of the product.

## °C/°F Conversion

The unit converses from °C to °F or from °F to °C if Room Temperature KEY  is pressed for 5 seconds.

## Display screen brightness

You can adjust the brightness of the indoor unit display screen.

- 1 Press  Turn on/off the Display screen.

### ! NOTE

This function may not be supported, depending on the model.

## Operating the air conditioner without the remote control

You can use the On/Off button of the indoor unit to operate the air conditioner when the remote control is unavailable. However, the fan speed is set to high.

### In case of turning On

- 1 Open the front panel.
  - Lift up both sides of the cover slightly.

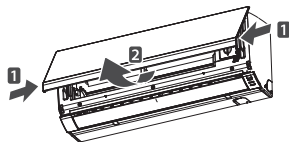

\* The feature can be changed according to a type of model.

- 2 Press the On/Off button.

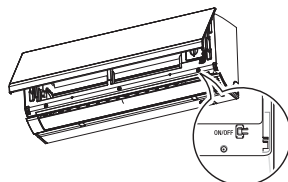

\* The feature can be changed according to a type of model.



- For cooling and heating models, the operation mode changes, depending on the room temperature.

Room temp.	Set temp.	Operation mode
Below 21°C	24°C	Heating operation
Above 21°C and below 24°C	23°C	Dehumidifying operation
Above 24°C	22°C	Cooling operation

### In case of turning Off

- 1 Open the front panel.
  - Lift up both sides of the cover slightly.

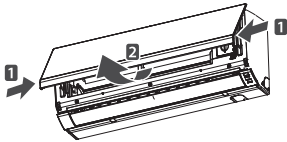

\* The feature can be changed according to a type of model.

- 2 Press the On/Off button.

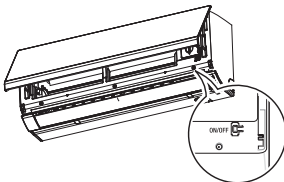

\* The feature can be changed according to a type of model.

## Restarting the air conditioner automatically

When the air conditioner is turned on again after a power failure, this function restores the previous settings. This function is a factory default setting.

### Disabling auto restart

- 1 Open the front cover.
  - Lift up both sides of the cover slightly.

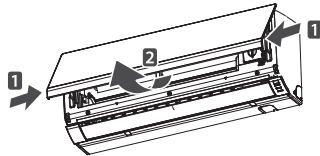

\* The feature can be changed according to a type of model.

- 2 Press the On/Off button and hold it for 6 seconds.
  - The unit will beep twice and the lamp will blink twice 4 times.

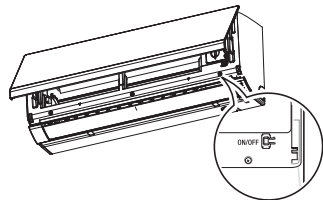

\* The feature can be changed according to a type of model.

- To re-enable the function, press the On/Off button and hold it for 6 seconds. The unit will beep twice and the blue lamp will blink 4 times.

### NOTE

- If you press and hold the On/Off button for 3 – 5 seconds instead of 6 seconds, the unit will switch to the test operation.
- In the test operation, the unit blows out strong air for cooling for 18 minutes and then returns to the factory default settings.

## MAINTENANCE

If the air conditioner will not be used for an extended of time, dry the air conditioner to maintain it in best condition.

- 1 Dry the air conditioner in Fan mode for 3 to 4 hours and disconnect the power plug. There may be internal damage if moisture is left in components.
- 2 Before using the air conditioner again, dry the inner components of the air conditioner in Fan mode for 3 to 4 hours. This will help to remove odor which is generated from moisture.

Clean the product regularly to maintain optimal performance and to prevent possible breakdown.

\* This may not be provided, depending on the model.

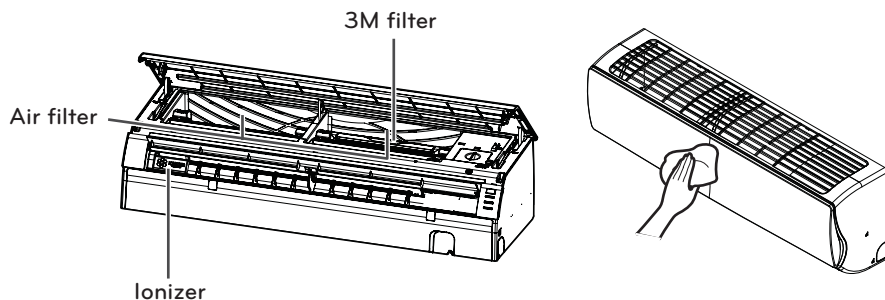

\* The feature can be changed according to type of model.

Type	Description	Interval
Air filter	See "Cleaning the Air filter."	2 weeks
Ionizer	See "Cleaning the Ionizer"	6 months
3M Filter	See " Cleaning the 3M Filter"	1 months
Indoor unit	Clean the Indoor unit surface by using a soft, dry cloth.	Regularly
	Clean the condensate drain pipe.	Every 4 months
	Clean the condensate drain pan.	Once a year
	Thoroughly clean the heat exchanger.	Once a year
	Replace the remote control batteries.	Once a year
Outdoor unit	Use steam to clean the heat exchanger coils and the panel vents. (consult with technician)	Regularly
	Clean the fan.	Once a year
	Clean the condensate drain pan.	Once a year
	Verify that all the fan assembly is firmly tightened.	Once a year
	Verify that electric components with jets of air.	Once a year
	Clean the electric components with jets of air.	Once a year

**Cleaning the ionizer**

- Turn off the power and unplug the power cord.
- Use dry cotton bud to remove any dust.

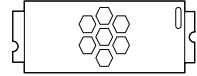
**CAUTION**

- Turn off the power and unplug the power cord before you perform any maintenance; otherwise it may cause electric shock.
- Never use water that is hotter than 40°C when you clean the filters. It may cause deformation or discoloration.
- Never use volatile substances when you clean the filters. They may damage the surface of the product.
- Do not wash the 3M filter with water, because the filter can be damaged

**NOTE**

- The location and shape of the filters may differ, depending on the model.
- Make sure to clean the heat exchanger coils of the outdoor unit regularly, as dirt collected in the coils may decrease the operational efficiency or increase energy costs.

## Cleaning the air filter

Clean the air filter once every 2 weeks or more if necessary.

- 1 Turn off the power and unplug the power cord.
- 2 Open the front cover.
  - Lift up both sides of the cover slightly.

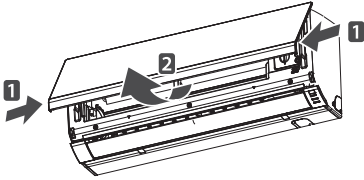

\* The Feature can change according to the model type.

- 3 Hold the knob of the air filter, lift it up slightly and remove it from the unit.

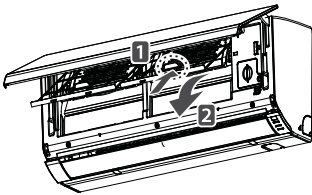

\* The Feature can change according to the model type.

- 4 Clean the filter with a vacuum cleaner or with warm water.
  - If dirt is difficult to remove, wash the filter in lukewarm water with detergent.
- 5 Dry the filter in the shade.

## Cleaning the 3M Filter

- 1 Turn off the power and unplug the power cord.
- 2 Open the front cover and remove the air filter (see "Cleaning air filter").
- 3 Remove the 3M Filter.

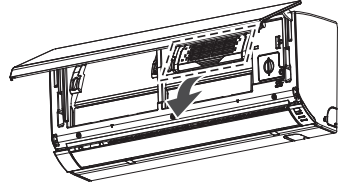

\* The Feature can change according to the model type.

- 4 Use a vacuum cleaner to remove dirt, Do not wash the 3M Filter with water, because the filter can be damaged.

### NOTE

- We suggest changing the 3M Filter every 6 Months
- The location of the filters may differ, depending on the model.
- If you need more filters, please contact the LG service center (Refer to the warranty card)

# TROUBLESHOOTING

## Self-diagnosis function

This product has a built-in self-diagnosis function. If an error occurs, the lamp of the indoor unit will blink in 2 second intervals. If this occurs, contact your local dealer or service center.

## Before requesting service

Please check the following before you contact the service center. If the problem persists, contact your local service center.

Problem	Possible causes	Corrective action
<b>Abnormal operating conditions.</b>	<ul style="list-style-type: none"> <li>• There is a burning smell and a strange sound coming from the unit.</li> </ul>	<ul style="list-style-type: none"> <li>• Turn off the air conditioner, unplug the power cord and contact the service center.</li> </ul>
	<ul style="list-style-type: none"> <li>• Water leaks from the indoor unit even when the humidity level is low.</li> </ul>	
	<ul style="list-style-type: none"> <li>• The power cord is damaged or generating excessive heat.</li> </ul>	
	<ul style="list-style-type: none"> <li>• A switch, a circuit breaker (safety, ground) or a fuse is not operated properly.</li> </ul>	
<b>The air conditioner does not work.</b>	<ul style="list-style-type: none"> <li>• The air conditioner is unplugged.</li> </ul>	<ul style="list-style-type: none"> <li>• Check whether the power cord is plugged into the outlet.</li> </ul>
	<ul style="list-style-type: none"> <li>• A fuse is blown or the power supply is blocked.</li> </ul>	<ul style="list-style-type: none"> <li>• Replace the fuse or check if the circuit breaker has tripped.</li> </ul>
	<ul style="list-style-type: none"> <li>• A power failure has occurred.</li> </ul>	<ul style="list-style-type: none"> <li>• Turn off the air conditioner when a power failure occurs.</li> <li>• When the power is restored, wait 3 minutes, and then turn on the air conditioner.</li> </ul>
	<ul style="list-style-type: none"> <li>• The voltage is too high or too low.</li> </ul>	<ul style="list-style-type: none"> <li>• Check if the circuit breaker has tripped.</li> </ul>
	<ul style="list-style-type: none"> <li>• The air conditioner turned off automatically at a preset time.</li> </ul>	<ul style="list-style-type: none"> <li>• Press the power button again.</li> </ul>
	<ul style="list-style-type: none"> <li>• Battery setting is wrong in the remote controller.</li> </ul>	<ul style="list-style-type: none"> <li>• Is the battery inserted in Remoted controller? Is the battery inserted with the correct terminal (+)(-)?</li> <li>• Even if you check the upper lists, the air conditioner does not operate. Please replace new batteries.</li> </ul>

Problem	Possible causes	Corrective action
<b>The air conditioner does not generate cool air.</b>	<ul style="list-style-type: none"> <li>• Air is not circulating properly.</li> </ul>	<ul style="list-style-type: none"> <li>• Make sure that there are no curtains, blinds or furniture blocking the front of the air conditioner.</li> </ul>
	<ul style="list-style-type: none"> <li>• The air filter is dirty.</li> </ul>	<ul style="list-style-type: none"> <li>• Clean the air filter once every 2 weeks.</li> <li>• See "Cleaning Air Filter" for more information.</li> </ul>
	<ul style="list-style-type: none"> <li>• The room temperature is too high.</li> </ul>	<ul style="list-style-type: none"> <li>• In summer, it may take some time to cool indoor air.</li> <li>• In this case, select the jet cool operation to cool indoor air quickly.</li> </ul>
	<ul style="list-style-type: none"> <li>• Cold air is escaping from the room.</li> </ul>	<ul style="list-style-type: none"> <li>• Make sure that no cold air is escaping through ventilation points in the room.</li> </ul>
	<ul style="list-style-type: none"> <li>• The desired temperature is higher than the set temperature.</li> </ul>	<ul style="list-style-type: none"> <li>• Set the desired temperature to a level lower than the current temperature.</li> </ul>
	<ul style="list-style-type: none"> <li>• There is a heating source nearby.</li> </ul>	<ul style="list-style-type: none"> <li>• Avoid using a heat generator such as an electric oven or a gas burner while the air conditioner is in operation.</li> </ul>
	<ul style="list-style-type: none"> <li>• Air circulation operation is selected.</li> <li>• Outside temperature is too high.</li> </ul>	<ul style="list-style-type: none"> <li>• In the air circulation operation, air blows from the air conditioner without cooling or heating the indoor air.</li> <li>• Switch the operation mode to the cooling operation.</li> <li>• The cooling effect may not be sufficient.</li> </ul>
<b>The air conditioner does not generate warm air.</b>	<ul style="list-style-type: none"> <li>• When the heating mode is started.</li> <li>• Vane is almost closed and air flow does not come out.</li> <li>• Even though outdoor unit is already begun to operate.</li> </ul>	<ul style="list-style-type: none"> <li>• This symptom is normal.</li> <li>• Please wait until the unit is preparing warm air.</li> <li>• This function prepare to blow warm air.</li> </ul>
	<ul style="list-style-type: none"> <li>• Defrosting mode is being done in the outdoor unit.</li> </ul>	<ul style="list-style-type: none"> <li>• In heating mode, ice/frost is built up on the coils when the outside temperature fall down.</li> <li>• This function remove a layer of frost on the coil.</li> <li>• Please wait until this operation is completed. It takes about 15 mins.</li> </ul>
	<ul style="list-style-type: none"> <li>• Outside temperature is too low.</li> </ul>	<ul style="list-style-type: none"> <li>• The heating effect may not be sufficient.</li> </ul>

Problem	Possible causes	Corrective action
<b>The air-conditioner stops during operation.</b>	<ul style="list-style-type: none"> <li>The air conditioner is suddenly turn off.</li> </ul>	<ul style="list-style-type: none"> <li>The timer function could be operated. If the timer function would operate, the air-conditioner can be turn off.</li> <li>Check the timer setting is correct.</li> </ul>
	<ul style="list-style-type: none"> <li>A power failure has occurred during operation.</li> </ul>	<ul style="list-style-type: none"> <li>There is the Auto Restart Function. It is a default setting.</li> <li>This function can turn on the unit automatically when the power is restored.</li> <li>If you live in frequent power failure area, this function would be useful.</li> </ul>
<b>Indoor unit is still operating even when the power is being turned off.</b>	<ul style="list-style-type: none"> <li>Auto-Clean mode is being operated.</li> <li>This function is to remove the rest of moisture indoor unit.</li> </ul>	<ul style="list-style-type: none"> <li>Please, wait until the end of functions.</li> <li>It will be inhibit a fungal growth. If you do not want this feature, you can turn off to press .</li> </ul>
<b>Mist is discharged from the air outlet of the indoor unit.</b>	<ul style="list-style-type: none"> <li>The cooled air from the air conditioner makes mist.</li> </ul>	<ul style="list-style-type: none"> <li>When the room temperature is down, this phenomenon will disappear.</li> </ul>
<b>Water leaks from the outdoor unit.</b>	<ul style="list-style-type: none"> <li>In the heating operations, condensed water drop from the heat exchanger.</li> </ul>	<ul style="list-style-type: none"> <li>This symptom need to install drain hose under the base pan.</li> <li>Contact the installer.</li> </ul>
<b>Operating noise or vibration.</b>	<ul style="list-style-type: none"> <li>Clicking sound Clicking sound can be heard either when the unit starts or stops due to movement of reversing valve.</li> <li>Creaking sound The plastic parts of the indoor unit make sound of shrinks and expands due to a sudden temperature change.</li> <li>The water flowing sound, Blowing sound The flow of refrigerant through the air conditioner is switching, noise can be heard.</li> </ul>	<ul style="list-style-type: none"> <li>These are normal symptoms.</li> <li>After a moment, it will be silent.</li> </ul>
<b>The indoor unit gives out odor.</b>	<ul style="list-style-type: none"> <li>The air smells bad because a musty or cigarettes odor may be absorbed into the indoor unit and discharged with airflow.</li> </ul>	<ul style="list-style-type: none"> <li>If the smell does not disappear, you need to wash filter or heat exchanger.</li> <li>Contact the installer.</li> </ul>





