



LG

Life's Good

OWNER'S MANUAL

MONITOR SIGNAGE

Please read this manual carefully before operating the your set and retain it for future reference.

MONITOR SIGNAGE MODELS

42LS55A 32LS53A

47LS55A 42LS53A

55LS55A 47LS53A

55LS53A

65LS53A

www.lg.com

TABLE OF CONTENTS

3 LICENSES

4 ASSEMBLY AND PREPARATION

- 4 Accessories
- 5 Optional Accessories
- 7 Parts and Buttons
- 8 Connecting the Stand
- 8 Connecting the Speakers
- 10 Connecting IR & Light Sensor
- 10 Portrait Layout
- 11 Installing on a Wall

13 REMOTE CONTROL

15 MAKING CONNECTIONS

- 15 Connecting to a PC
- 16 External Device Connection
- 18 Using the Input List

18 ENTERTAINMENT

- 18 Using My Media
- 18 - Connecting USB storage devices
- 20 - Files Supported by My Media
- 23 - Viewing Videos
- 25 - Viewing Photos
- 25 - Listening to Music
- 26 - Settings
- 27 SuperSign Contents
- 27 Information
- 27 File Manager
- 28 Picture ID Settings

29 USER SETTINGS

- 29 Main Menu Settings
- 29 - Quick Settings
- 30 - Picture Settings
- 34 - Sound Settings
- 35 - Network Settings
- 38 - General Settings

39 TROUBLESHOOTING

41 PRODUCT SPECIFICATIONS

57 IR CODES

59 TO CONTROL MULTIPLE PRODUCTS

- 59 Connecting the cable
- 59 RS-232C Configurations
- 59 Communication Parameter
- 60 Command Reference List
- 62 Transmission/Reception Protocol

WARNING: This product contains chemicals known to the State of California to cause cancer and birth defects or other reproductive harm. ***Wash hands after handling.***

LICENSSES

Supported licenses may differ by model. For more information of the licenses, visit www.lg.com.



The terms HDMI and HDMI High-Definition Multimedia Interface, and the HDMI logo are trademarks or registered trademarks of HDMI Licensing LLC in the United States and other countries.



This DivX Certified® device has passed rigorous testing to ensure it plays DivX® video. To play purchased DivX movies, first register your device at vod.divx.com. Find your registration code in the DivX VOD section of your device setup menu.

DivX Certified® to play DivX® video up to HD 1080p, including premium content.

DivX®, DivX Certified® and associated logos are trademarks of DivX, LLC and are used under license.

Covered by one or more of the following U.S. patents: 7,295,673; 7,460,668; 7,515,710; 7,519,274.



Manufactured under license from Dolby Laboratories. Dolby and the double-D symbol are trademarks of Dolby Laboratories.



For DTS patents, see <http://patents.dts.com>. Manufactured under license from DTS Licensing Limited. DTS, the Symbol, & DTS and the Symbol together are registered trademarks, and DTS 2.0 Channel is a trademark of DTS, Inc. © DTS, Inc. All Rights Reserved.



NOTE

- The warranty will not cover any damage caused by using the product in an excessively dusty environment.

ASSEMBLY AND PREPARATION

Accessories

Please check whether all the components are included in the box before using the product. If there are any missing components, contact the retail store where you purchased the product. The illustrations in this manual may differ from the actual product and accessories.

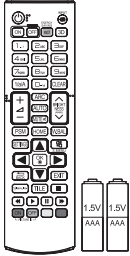

Remote Control,
Batteries (AAA) 2EA

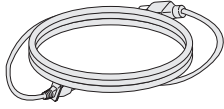

Power Cord

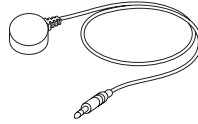

IR & Light Sensor



CD (Owner's Manual)/
Card

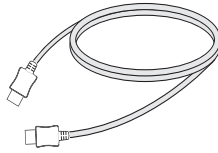

HDMI Cable



CAUTION

- Always use genuine components to ensure safety and product performance.
- The product warranty will not cover damage or injury caused by the use of counterfeit components.



NOTE

- The accessories provided with your product may vary depending on the model or region.
- Product specifications or contents in this manual may be changed without prior notice due to upgrade of product functions.
- SuperSign Software & Manual
 - Downloading from the LG Electronics website.
 - Visit the LG Electronics website (www.lgcommercial.com/supersign) and download the latest software for your model.

Optional Accessories

Without prior notice, optional accessories are subject to change to improve the performance of the product, and new accessories may be added. The illustrations in this manual may differ from the actual product and accessories.

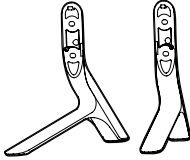

Stand

ST-321T	32LS53A
ST-421T	42LS53A/ 42LS55A
ST-471T	47LS53A/ 47LS55A 55LS53A/ 55LS55A
ST-651T	65LS53A



Screws

Diameter 4.0 mm x Pitch 0.7 mm x
Length 14 mm (including spring washer)

Stand kit

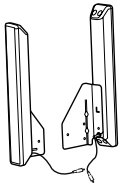

**Speakers
SP-2100**



**Cable Holders/
Cable Ties**



Screws
Diameter 4.0 mm x Pitch
0.7 mm x Length 8 mm
(including spring washer)

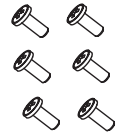

Screws
Diameter 4.0 mm x Pitch
1.6 mm x Length 10 mm

Speaker kit



NOTE

- Cable holder/Cable tie may not be available in some areas or for some models.
- Optional accessories are available for some models. If necessary, please purchase them separately.

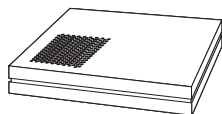

**Media Player
MP500/MP700**



Screws



**Owner's Manual
(supplied on CD-ROM) /
Card**

Media Player kit

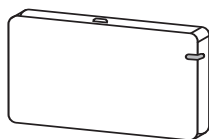

AN-WF500

Wi-Fi Dongle kit

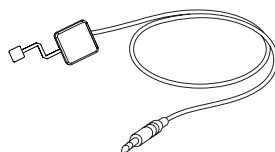

KT-SP0

Pixel sensor kit



NOTE

- Optional accessories are available for some models. If necessary, please purchase them separately.
- Pixel sensor is sold separately. You can obtain additional accessories from your local retail store.

Parts and Buttons

ENGLISH

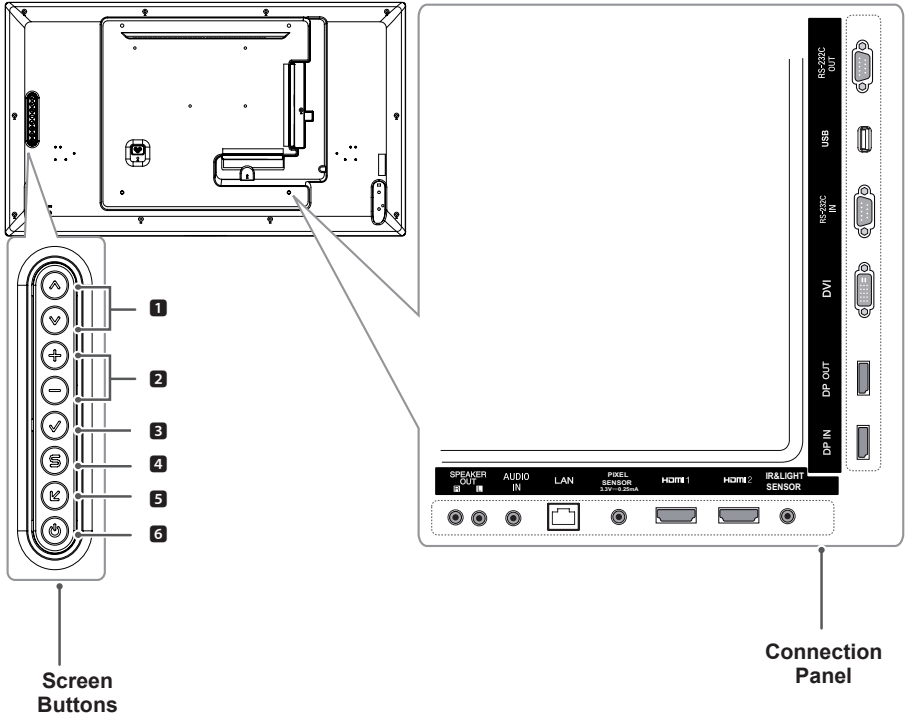

No.	Description
1	Adjusts up and down.
2	Moves left and right.
3	Displays the current signal and mode.
4	Accesses the main menus, or saves your input and exits the menus.
5	Change the input signal.
6	Turns the power on or off.

Connecting the Stand

- For certain models only.

- 1 Place a soft cloth on the table and place the product with the screen facing downward.

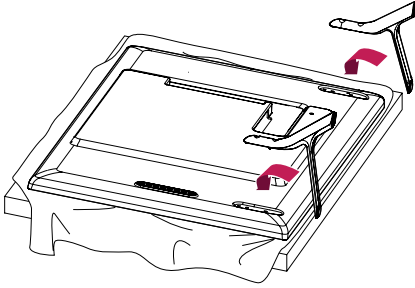

- 2 Use the screws to secure the stand to the back of the product as shown below.

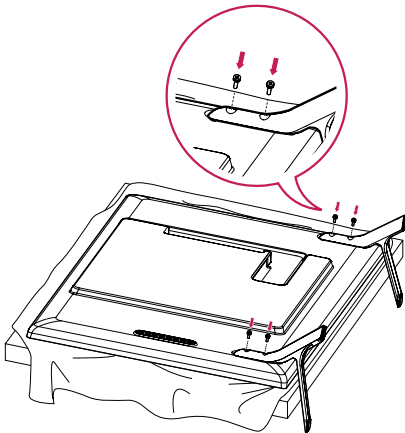

Connecting the Speakers

- For certain models only.

32LS53A

- 1 Connect an input signal cable before installing the speakers.

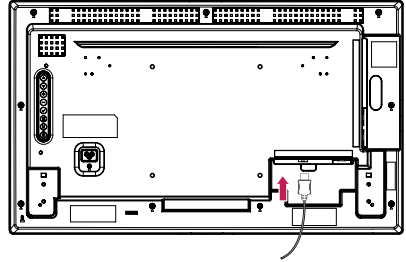

- 2 Mount the speakers by using screws as shown below. Make sure the power cable is disconnected before making a connection.

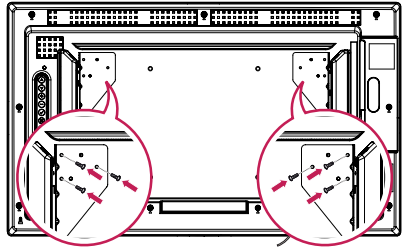

- 3 Connect the speaker cables noting the correct polarity. Use cable holders and cable ties to organize the speaker cables.

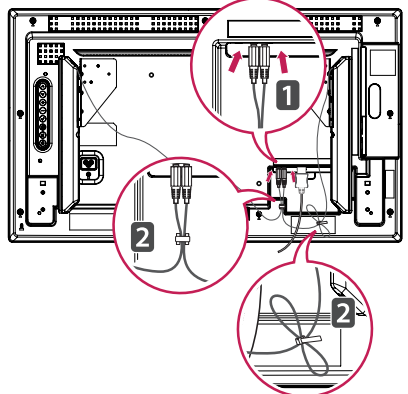

42LS55A	47LS55A	55LS55A
42LS53A	47LS53A	55LS53A
65LS53A		

- 1 Connect an input signal cable before installing the speakers.

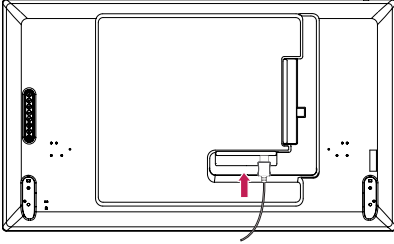

- 2 Mount the speakers by using screws as shown below. Make sure the power cable is disconnected before making a connection.

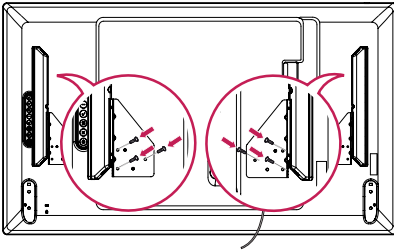

- 3 Connect the speaker cables noting the correct polarity. Use cable holders and cable ties to organize the speaker cables.

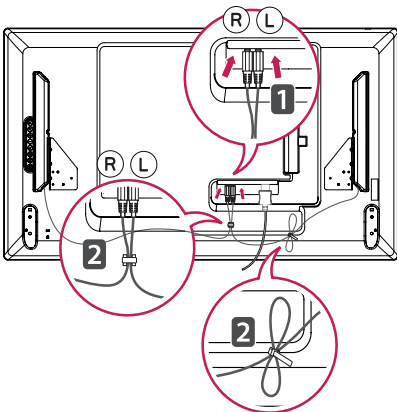

NOTE

- Please turn off the power before removing the cable. Connecting or removing the speaker cable while turned on may result in no sound.

Connecting IR & Light Sensor

When you connect the cable to the product, the feature for receiving remote control signals is activated. The IR & light sensor is magnetic. Attach it to the front edge of the product for use.

[Front]

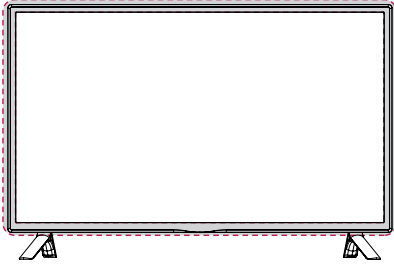

Portrait Layout

When installing in a portrait layout, rotate the monitor counterclockwise 90 degrees (when facing the screen).

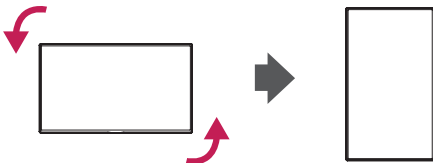

Using Kensington Lock

(This is not available for all models.)

The Kensington security system connector is located at the back of the monitor. For more information on installation and use of this system, refer to the manual provided with the Kensington security system or visit <http://www.kensington.com>.

Connect the Kensington security system cable between the monitor and a table.

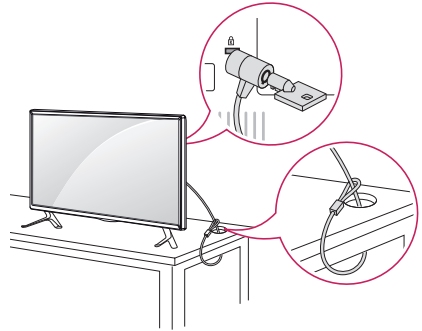

NOTE

- The Kensington security system is optional. You can obtain additional accessories from most electronics retail stores.

Installing on a Wall

For proper ventilation, allow a clearance of 10 cm on each side and from the wall. Detailed installation instructions are available from your dealer, see the optional Tilt Wall Mounting Bracket Installation and Setup Guide.

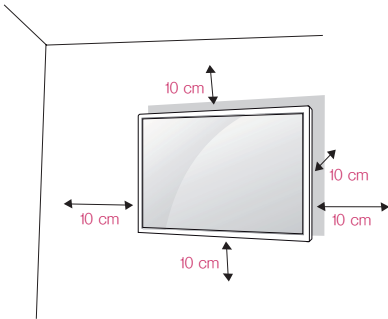

To install your monitor on a wall, attach a wall mounting bracket (optional part) to the back of the monitor.

Make sure that the wall mounting bracket is securely fixed to the monitor and to the wall.

- 1 Use only screws and wall mounting brackets that conform to VESA standards.
- 2 Screws which are longer than standard length may damage the inside of the monitor.
- 3 A non-VESA standard screw may damage the product and cause the monitor to fall. LG Electronics is not liable for any accidents related to the use of non-standard screws.
- 4 Please use VESA standard as below.
 - 785 mm and above
 - * Fixing screws: Diameter 6.0 mm x Pitch 1.0 mm x Length 12 mm

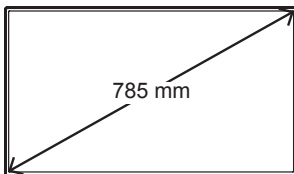

CAUTION

- Disconnect the power cord before moving or installing the monitor to avoid risk of electric shock.
- If you install the monitor on a ceiling or slanted wall, it may fall and result in injury. Use an authorized LG wall mount and contact your local dealer or qualified personnel to assist with the installation.
- Do not over tighten the screws as this may damage the monitor and void your warranty.
- Use only screws and wall mounting brackets that meet the VESA standard. Any damage or injuries caused by misuse or use of improper accessories are not covered by the warranty.



NOTE

- The wall mount kit includes the installation guide and all necessary parts.
- The wall mounting bracket is optional. You can obtain additional accessories from your local dealer.
- The length of screws required may differ depending on the wall mount. Be sure to use the correct length.
- For more information, please refer to the guide provided with the wall mount.

Securing the monitor to a wall (optional)

Procedure may differ depending on the model.

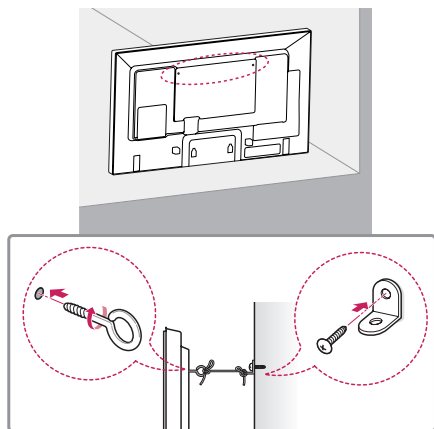

- 1 Insert and tighten the eyebolts, or brackets and bolts on the back of the monitor.
 - If there are already bolts inserted in the eyebolts' position, remove the other bolts first.
- 2 Mount the wall brackets with the bolts to the wall. Match the location of the wall bracket and the eyebolts on the rear of the monitor.
- 3 Connect the eyebolts and wall brackets tightly with a sturdy cord. Make sure the securing cord is horizontal with the flat surface.

**CAUTION**

- Make sure that children do not climb on or hang from the monitor.

**NOTE**

- Use a platform or cabinet that is large and strong enough to support the monitor securely.
- Brackets, bolts, and cords are sold separately. You can obtain additional accessories from your local retail store.
- The illustration shows a general example of installation and may look different from the actual product.

**WARNING**

- If the monitor is not positioned in a sufficiently stable location, there is a danger that it will fall. Many injuries, particularly to children, can be avoided by taking simple precautions such as:
 - » Using cabinets or stands recommended by the manufacturer.
 - » Only using furniture that can safely support the monitor.
 - » Ensuring the monitor is not overhanging the edge of the supporting furniture.
 - » Not placing the monitor on tall furniture (for example, cupboards or bookcases) without anchoring both the furniture and the monitor to a suitable support.
 - » Not placing cloth or other materials between the monitor and supporting furniture.
 - » Educating children about the dangers of climbing on furniture to reach the monitor or its controls.

REMOTE CONTROL

The descriptions in this manual are based on the buttons on the remote control. Please read this manual carefully to use the monitor correctly.

To install batteries, open the battery cover, place batteries (1.5 V AAA) matching ⊕ and ⊖ terminals to the labels inside the compartment, and close the battery cover.

To remove the batteries, perform the installation actions in reverse. The illustrations may differ from the actual accessories.



CAUTION

- Do not mix old and new batteries, as this may damage the remote control.
- Be sure to point the remote control toward the remote control sensor on the monitor.

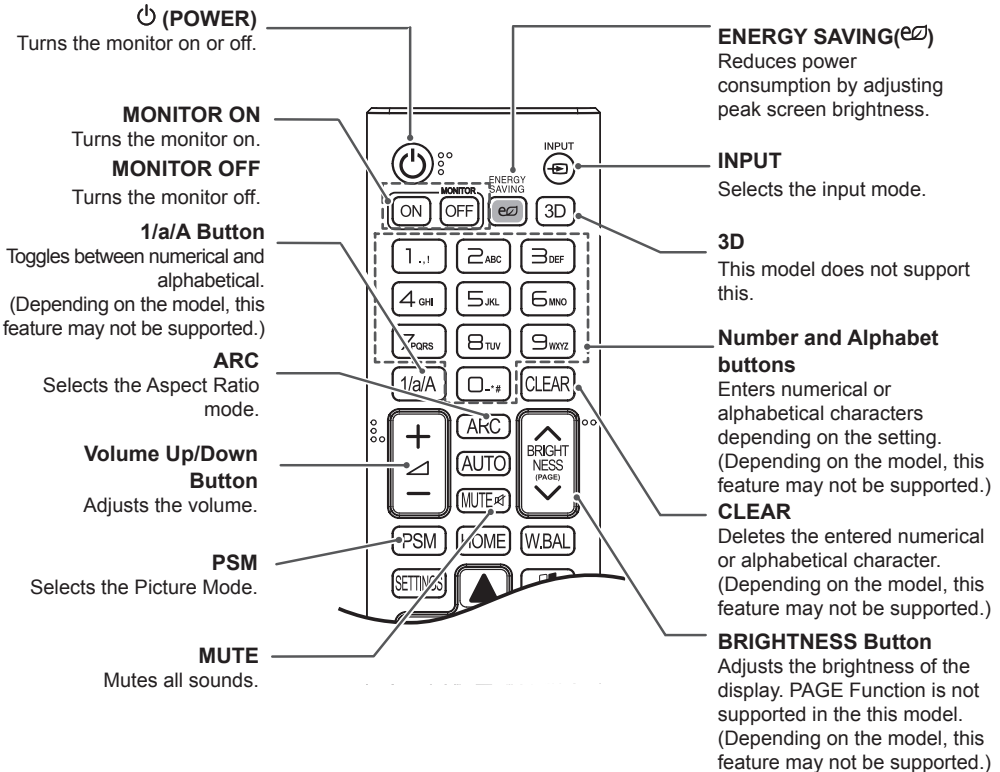
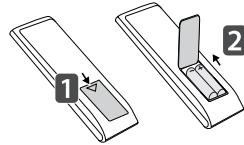

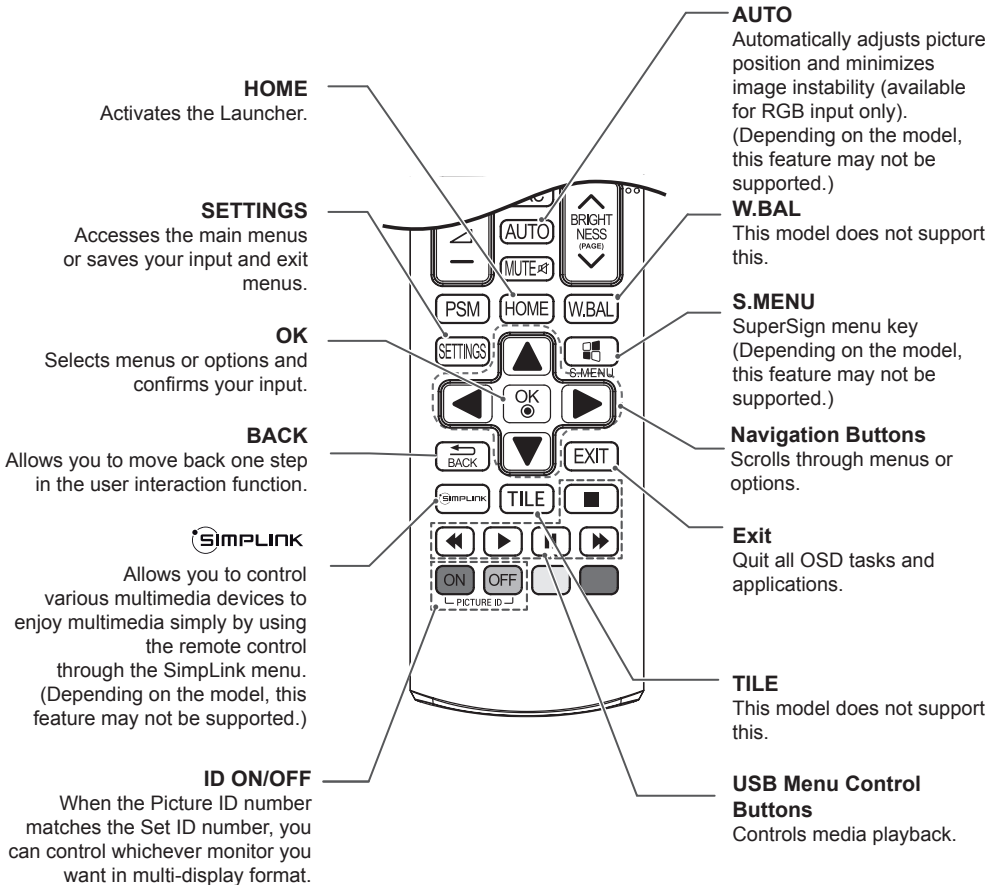

MAKING CONNECTIONS

You can connect various external devices to your monitor. Change the input mode and select the external device you want to connect.

For more information about external device connections, see the user manual provided with each device.

Connecting to a PC

The illustrations may differ from the actual accessories. Some of the cables are not provided.

This monitor supports the Plug & Play* feature.

* Plug & Play: a feature that enables a PC to recognize devices attached by the user without device configuration or user intervention when powering up.

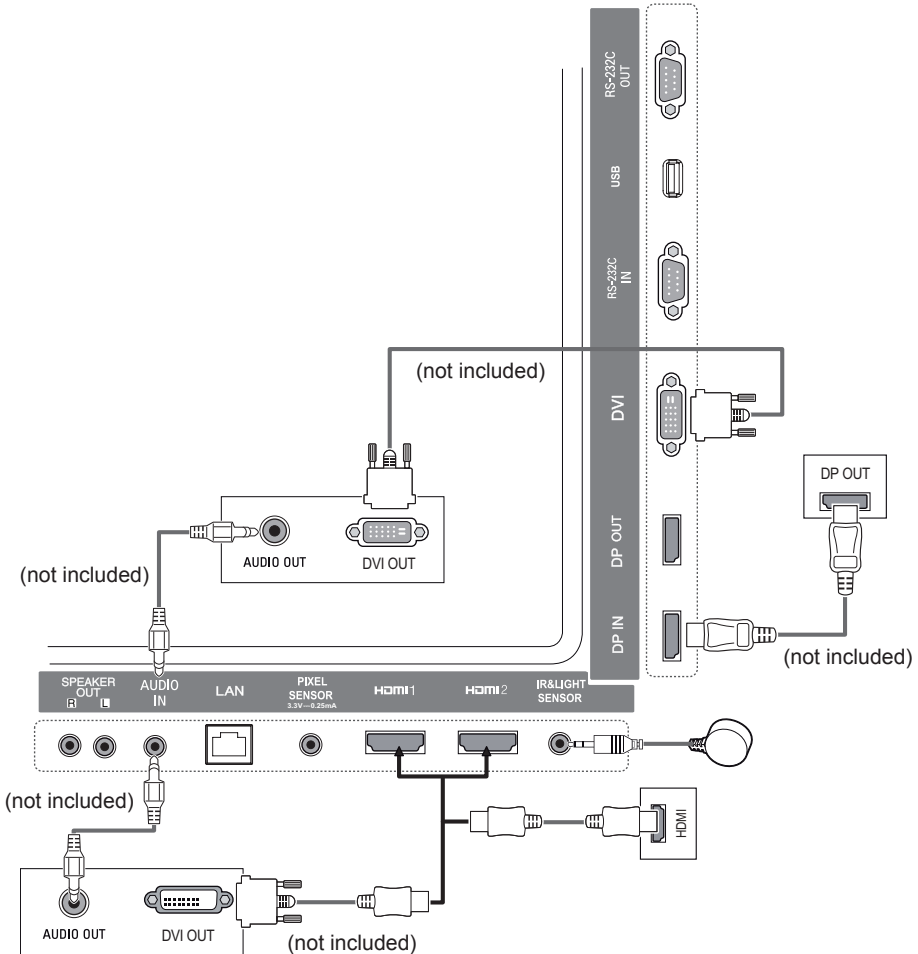

External Device Connection

Connect a HD receiver, DVD, or VCR player to the monitor and select an appropriate input mode. The illustrations may differ from the actual accessories. Some of the cables are not provided. For the best picture and sound quality, connecting external devices to your monitor using HDMI cables is recommended.

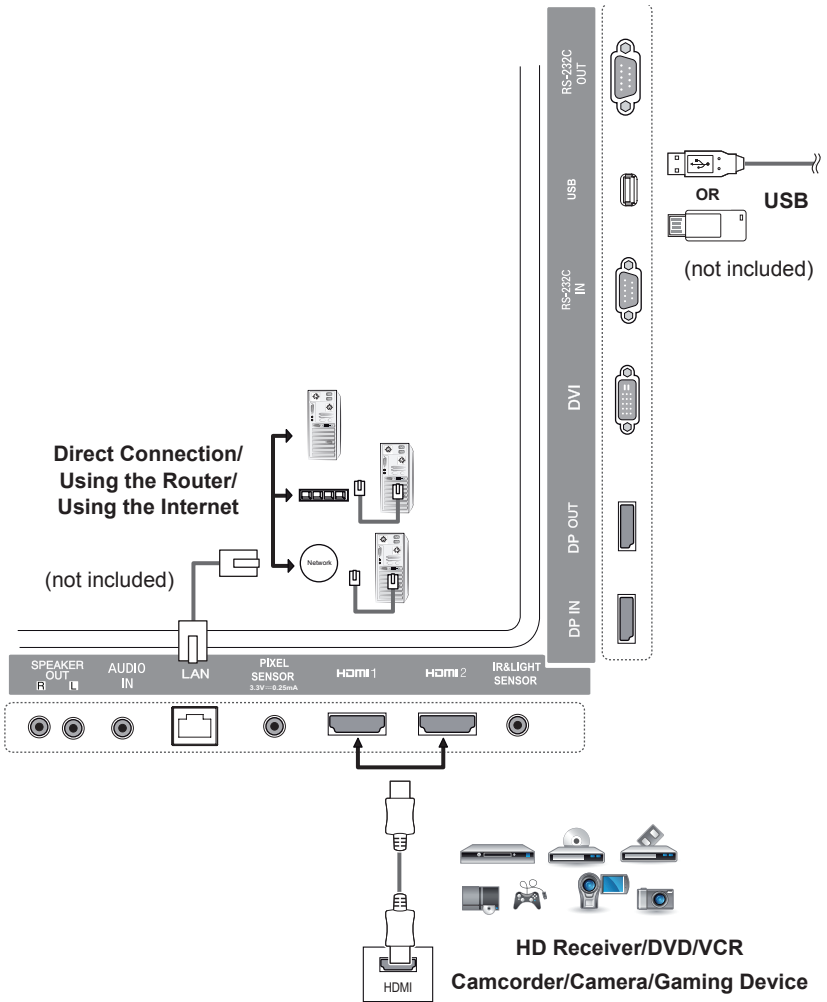

**NOTE**

- For the best image quality, using the monitor with HDMI connection is recommended.
- To comply with the standard specifications of the product, use a shielded interface cable with a ferrite core, such as a DVI cable.
- If you turn the monitor on when the set is cold, the screen may flicker. This is normal.
- Sometimes red, green, or blue spots may appear on the screen. This is normal.
- Use a High Speed HDMI^{®/TM} cable.
- Use a certified cable with the HDMI logo attached. If you do not use a certified HDMI cable, the screen may not display or a connection error may occur.
- Recommended HDMI Cable Types
 - High-Speed HDMI^{®/TM} Cable
 - High-Speed HDMI^{®/TM} Cable with Ethernet
- If you cannot hear any sound in HDMI mode please check your PC settings. Some PCs require you to manually change the default audio output to HDMI.
- If you want to use HDMI-PC mode, you must set your PC/DTV to PC mode.
- You may experience compatibility issues if you use HDMI-PC mode.
- Make sure the power cable is disconnected.
- If you connect a gaming device to the monitor, use the cable provided with the gaming device.
- It is recommended to use the speakers that are provided as optional accessories.
- High Speed HDMI^{®/TM} cables transmit a HD signal up to 1080p and higher.

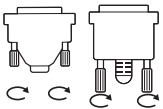
**CAUTION**

- Connect the signal input cable and tighten it by turning the screws clockwise.
- Do not press the screen with your finger for a prolonged period as this may result in temporary distortion on the screen.
- Avoid displaying static images on the screen for a long period of time to prevent image burn. Use a screensaver if possible.
- A wireless communication device near your monitor can affect the image.

Using the Input List

Remote Control (HOME) → 

Input Mode	Description
HDMI1	
HDMI2	You can watch content on a PC, DVD player, Digital set-top box, and other high definition devices.
DisplayPort	
DVI	

ENTERTAINMENT

Using My Media

Connecting USB storage devices

Connect a USB storage device such as a USB flash memory or an external hard drive to the display and use multimedia features.

Connect a USB flash memory or USB memory card reader to the display as shown in the following illustration.

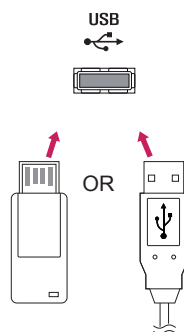

CAUTION

- Do not turn off the monitor or remove a USB storage device when the **My Media** screen is activated. This could result in loss of files or damage to the USB storage device.
- Back up files you have saved on a USB storage device frequently, as loss or damage to the files may be not covered by the warranty.

Tips for using USB storage devices

- Only a USB storage device can be recognized.
- A USB device does not work effectively when it is connected via a USB hub.
- A USB storage device using an automatic recognition program may not be recognized.
- A USB storage device using its own driver may not be recognized.
- The recognition speed of a USB storage device may depend on each device.
- Please do not turn off the display or unplug the USB storage device when the connected device is working. If the USB storage device is suddenly disconnected, the stored files or the device itself may be damaged.
- Please do not connect a USB storage device which was modified to work on a PC. The device may cause the monitor to malfunction or the content fail to be played. Use only a USB storage device which contains normal music, image or video files.
- A USB storage device formatted as a utility program not supported by Windows may not be recognized.
- A USB storage device (over 0.5 A) which requires an external power supply must be connected to a power supply separately. If it is not, the device may not be recognized.
- Please connect the USB storage device using the cable provided by the device manufacturer.
- Some USB storage devices may not be supported or operate smoothly.
- File alignment method of USB storage devices is similar to that of Windows XP and filenames can recognize up to 100 English characters.
- Back up important files regularly as data stored on a USB storage device may be damaged. We will not be responsible for any data loss.
- If the USB HDD does not have an external power source, the USB device may not be detected. To ensure the device is detected, connect the external power source.
 - Please use a power adapter for an external power source. We do not provide a USB cable for an external power source.
- If your USB storage device has multiple partitions, or if you use a USB multi-card reader, you can use up to four partitions or USB storage devices.
- If a USB storage device is connected to a USB multi-card reader, its volume data may not be detected.
- If the USB storage device does not work properly, disconnect and reconnect it.
- Detection speed differs from device to device.
- If the USB storage device is connected in Standby Mode, the specific hard disk will automatically be loaded when the display is turned on.
- The recommended capacity is 1 TB or less for a USB external hard drive and 32 GB or less for USB memory stick.
- Any device with more than the recommended capacity may not work properly.
- If a USB external hard drive with an "Energy Saving" function does not work, try turning the hard drive off and on again.
- USB storage devices below USB 2.0 are also supported but may not function correctly in the Videos.
- A maximum of 999 sub-folders or files can be recognized under one folder.

Files Supported by My Media

Supported External Subtitle Format

- *.smi, *.srt, *.sub (MicroDVD, SubViewer 1.0/2.0), *.ass, *.ssa, *.txt (TMPlayer), *.psb (PowerDivX), *.dcs (DLP Cinema)

To use Select Play,

Remote Control (HOME) →  → Photos/ Videos/ Music → 

- **Play Selection:** plays back selected content.

To set Device Selection,

Remote Control (HOME) →  → Photos/ Videos/ Music → 

- **Device Selection:** import contents from the selected device.

Supported Internal Subtitle Format

- FULL HD Video
1920 X 1080: XSUB (Supports internal subtitles generated from DivX6)

Supported Video Codec

Extension	Codec	
.asf .wmv	Videos	VC-1 Advanced Profile (excluding WMVA), VC-1 Simple and Main Profiles
	Audio	WMA Standard (excluding WMA v1/WMA Speech), WMA 9 Professional
.divx .avi	Videos	DivX3.11, DivX4, DivX5, DivX6, XviD (except 3 warp-point GMC), H.264/AVC, Motion Jpeg, MPEG-4
	Audio	MPEG-1 Layer I, II, MPEG-1 Layer III (MP3), Dolby Digital, Dolby Digital Plus, LPCM, ADPCM, DTS
.mp4 .m4v .mov	Videos	H.264/AVC, MPEG-4
	Audio	AAC, MPEG-1 Layer III (MP3)
.3gp .3g2	Videos	H.264/AVC, MPEG-4
	Audio	AAC, AMR-NB, AMR-WB
.mkv	Videos	MPEG-2, MPEG-4, H.264/AVC, VP8
	Audio	Dolby Digital, PCM, DTS, MPEG-1 Layer I, II, MPEG-1 Layer III (MP3), Vorbis, AAC
.ts .trp .tp .mts	Videos	H.264/AVC, MPEG-2
	Audio	MPEG-1 Layer I, II, MPEG-1 Layer III (MP3), Dolby Digital, Dolby Digital Plus, AAC, PCM
.mpg .mpeg .dat	Videos	MPEG-1, MPEG-2
	Audio	MPEG-1 Layer I, II, MPEG-1 Layer III (MP3)
.vob	Videos	MPEG-1, MPEG-2
	Audio	Dolby Digital, MPEG-1 Layer I, II, DVD-LPCM

Supported Audio File

File Format	Item	Information
.MP3	Bit rate	32 Kbps - 320 Kbps
	Sample freq.	16 KHz - 48 KHz
	Support	MPEG1, MPEG2, Layer2, Layer3
.wav	Support	PCM
.ogg	Support	Vorbis
.wma	Support	WMA

Supported Photo File

File Format	Format	Item
2D (jpeg, jpg, jpe)	JPEG	<ul style="list-style-type: none"> • Minimum : 64 x 64 • Maximum: Normal Type: 15360 (W) x 8640 (H) / Progressive Type: 1920 (W) x 1440 (H)
2D (png)	PNG	<ul style="list-style-type: none"> • Minimum : 64 x 64 • Maximum: 1920 (W) x 1080 (H)
2D (bmp)	BMP	<ul style="list-style-type: none"> • Minimum : 64 x 64 • Maximum: 1920 (W) x 1080 (H)

Viewing Videos

Play video files on display. All of the saved video files are shown in your display.

To play video files on display,

Remote Control (HOME) →  **→ Videos**

Tips for Playing Video Files

- Some user-created subtitles may not work properly.
- Some special characters in subtitles are not rendered.
- HTML tags are not supported in subtitles.
- Subtitles in languages other than the supported languages are not available.
- The screen may suffer temporary interruptions (image stoppage, faster playback, etc.) when the audio language is changed.
- A damaged video file may not play correctly, or some player functions may not be usable.
- Video files produced with some encoders may not be played correctly.
- If the video and audio structure of a recorded file is not interleaved, either video or audio is outputted.
- Depending on the frame, HD videos with a maximum of 1920 x 1080 @ 25/30 P or 1280 x 720 @ 50/60P are supported.
- Depending on the frame, videos with resolutions higher than 1920 x 1080 @ 25/30 P or 1280 x 720 @ 50/60 P may not play correctly.
- Video files other than the specified types and formats may not play correctly.
- Maximum bit rate of playable video file is 20 Mbps. (Motion JPEG: 10 Mbps only)
- We cannot guarantee smooth playback of files encoded level 4.1 or higher in H.264 / AVC.
- Video files more than 30 GB in file size are not supported.
- A DivX video file and its subtitle file must be located in the same folder.
- A video file name and its subtitle file name must be identical for it to be displayed.
- Playing a video via a USB connection that does not support high-speed connection may not function correctly.
- Files encoded with Global Motion Compensation(GMC) may not be played.

**NOTE**

- Option values changed in **Videos** do not affect the **Photos** and **Music**, and in turn are not affected by option values changed in **Photos** or **Music**.
- Option values changed in **Photos** and **Music** do affect each other.
- When restarting a video file after stopping it, you can play from the point at which it was stopped.

**NOTE**

- Only 10,000 sync blocks can be supported within the subtitle file.
- When playing a video, you can adjust the picture size by pressing the **ARC** button.
- Korean subtitle is supported only when the OSD menu is in Korean.
- The code page options may be disabled depending on the language of the subtitle files.
- Select the appropriate code page for the subtitle files.

Viewing Photos

The displays on the screen may differ from the model.

Viewing image files

Remote Control (HOME) →  → Photos









Listening to Music

Viewing music files

Remote Control (HOME) →  → Music



NOTE

- Files with unsupported extensions are not displayed.
- If a file is invalid, a broken image and the message "unrecognizable file" are displayed.
- Damaged music files are displayed as 00:00 and will not be played.
- A music file downloaded from a paid service with copyright protection will not play, and inappropriate information may be displayed during playback.
- You can use , , , ,  buttons on the remote control also in this mode.
- You can use the  button to select the next track and the  button to select the previous track.
- If you press the  button within 5 seconds after playing the song, you will return to the previous song; if you press the same button after 5 seconds, you will return to the start of the song.

Settings

You must register your product to play a DRM-protected DivX video.

In order to register/deregister purchased or rented DivX® VOD contents

Remote Control (HOME) →  → Settings → DivX® VOD

In order to play purchased or rented DivX® VOD contents, you should register your device with 10 digit DivX registration code from your device at www.divx.com/vod.

- **Registration:** view the registration code of your display.
- **Deregistration:** cancel the registration.

NOTE

- While you are checking the registration code, some buttons may not work.
- If you use the DivX registration code of another device, you cannot play rented or purchased DivX files. Use only the DivX registration code assigned to your product.
- Video or audio files that are not converted using the standard DivX codec may be corrupted or not play.
- The DivX VOD code allows you to activate up to 6 devices under one account.
- After deregistration, you must register your device again to see DivX® VOD contents.

SuperSign Contents

Plays stored files using the Export option in SuperSign Editor.

To play back the stored files using the Export option

Remote Control (HOME) →



Only contents distributed by SuperSign Manager are displayed and selectable.

NOTE

- If there is an AutoPlay folder in the USB storage device and its files are in supported formats, they will be played back automatically when the USB storage device is connected to the monitor.

File Manager

You can move, copy or delete files.

To move, copy, or delete files

Remote Control (HOME) →



- You can move or copy files or folders from internal to external memory.
- You can move or copy files or folders from external to internal memory.
- You can delete files or folders from internal or external memory.

NOTE

- This app is for managing files and therefore cannot play media files. To play media files, launch **My Media**.
- Those files bigger than internal remaining memory aren't allowed to be copied or moved to the internal memory.

Information

To check the basic information of Signage

Remote Control (HOME) →



You can see the basic information on Signage.

You can also switch to **Smart Energy Saving Mode** or configure **Fail Over** settings. (You can only switch to **Smart Energy Saving Mode** when **Energy Saving Mode** is set to Off.)

Picture ID Settings

Picture ID is used to change the settings of a specific set (display) using a single IR receiver for multi-vision. Communication is possible between a monitor with an IR receiver and other monitors using RS-232C cables. Each monitor is identified by a **Set ID**. If you assign the **Picture ID** using the remote control, only displays with matching **Picture ID** and **Set ID** can be controlled remotely.

- 1 Assign the **Set ID** to the installed monitors as shown below.

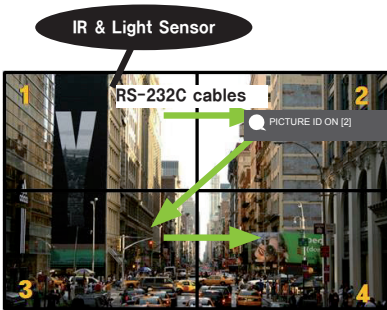

- 2 Press the red ON button on the remote control to assign the **PICTURE ID**.

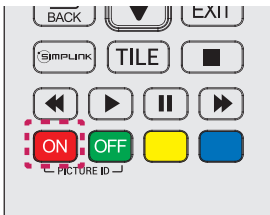

- 3 Assign the **Set ID** to the selection of your choice.

- A set with a different **Set ID** from the **Picture ID** cannot be controlled by IR signals.

NOTE

- If **Picture ID** is set to 2, only the upper right monitor, which has a **Set ID** of 2, can be controlled by IR signals.
- If you press the green **OFF** button for **PICTURE ID**, the **Picture IDs** for all monitors are turned off. If you then press any button on the remote control, all monitors can be controlled by IR signals regardless of **Set ID**.
- With **PICTURE ID ON**, you can only increase the **Picture ID** by 1. You cannot decrease it.

User Settings

Main Menu Settings

Quick Settings

Configures frequently used settings menus.

To turn your monitor on or off automatically

Remote Control (SETTINGS) → Quick → On Timer/Off Timer

You can set the On/Off Timer for your monitor. If you do not want to set the **On/Off Timer**, select **Off** in Repeat.

To set the backlight and contrast automatically

Remote Control (SETTINGS) → Quick → Smart Energy Saving

According to picture brightness, the brightness of the monitor will be adjusted automatically to save energy.

- **Off**: disables the **Smart Energy Saving** function.
- **On**: enables the **Smart Energy Saving** function.

Picture Settings

To Select Picture Mode

Remote Control (SETTINGS) → Picture → Picture Mode

Select the picture mode that is best suited to the video type.

- **Vivid:** adjusts the video image for a retail environment by enhancing the **contrast**, **brightness**, and **sharpness**.
- **Standard:** adjusts the video image for a normal environment.
- **APS:** APS (Auto power saving) mode reduces power consumption by dimming control.
- **Cinema:** optimizes the video image for watching movies.
- **Sports:** optimizes the video image for watching sports. Even fast actions such as kicking or throwing a ball are rendered clearly on the screen.
- **Game:** optimizes the video image for playing videogames.
- **Expert 1/Expert 2:** allows an expert, or anyone interested in high quality pictures, to manually tune the picture for the best picture quality. This adjustment menu is provided for ISF-certified picture quality tuning experts. (The ISF logo can only be used on ISF-certified monitors.)



NOTE

- Depending on the input signal, the available **picture modes** may differ.
- **Expert** is an option that allows a picture quality expert to fine-tune the picture quality using a specific image. Thus, it may not be effective for a normal picture.

To fine-tune the picture mode

Remote Control (SETTINGS) → Picture → Picture Adjust

- **Backlight:** adjusts the brightness of the screen by controlling the LCD backlight. The closer the value is to 100, the brighter the screen is.
- **Contrast:** adjusts the difference between the light and dark areas of the picture. The closer the value is to 100, the greater the difference is.
- **Brightness:** adjusts the overall brightness of the screen. The closer the value is to 100, the brighter the screen is.
- **Sharpness:** adjusts the sharpness of the edges of objects. The closer the value is 50, the clearer and the sharper the edge becomes.
- **H Sharpness:** adjusts the sharpness of the contrast edges on the screen from a horizontal point of view.
- **V Sharpness:** adjusts the sharpness of the contrast edges on the screen from a vertical point of view.
- **Color:** softens or deepens the tints on the screen. The closer the value is 100, the deeper the colors become.
- **Tint:** adjusts the balance between red and green levels displayed on the screen. The closer the value is to Red 50, the deeper the color red becomes, and the closer the value is to Green 50, the deeper the color green becomes.
- **Color Temperature:** adjusts the tints of the screen to evoke feelings of warmth or coolness.
- **Advanced Control/Expert Control:** customizes the advanced options.

Dynamic Contrast	Optimizes the difference between the light and dark parts of the screen according to the brightness of the image.
Super Resolution	Sharpens the blurry or indistinguishable parts of the picture.
Color Gamut	Selects the range of colors to display.
Dynamic Color	Adjusts the tint and saturation of the image for a more vivid and lively display.
Edge Enhancer	Provides much sharper and clearer edges to the picture.
Color Filter	Accurately adjusts color and tint by filtering a specific color area of RGB space.
Preferred Color	Adjusts the skin tint, grass tint, and sky tint to your preference.
Gamma	Adjusts the medium brightness of the image.
White Balance	Adjusts the overall tint of the picture to your preference. In Expert mode, you can fine-tune the picture using the Method/Pattern options.
Color Management System	Experts use the color management system when they adjust the colors by using the test pattern. The color management system allows you to make an adjustment by selecting from among 6 different color spaces (Red/Yellow/Blue/Cyan/Magenta/Green) without affecting other colors. You may not see tints change in a normal picture even after adjustment.



NOTE

- Depending on the input signal or the selected picture mode, the available options may differ.

- **Picture Options:** customizes the picture options.

Noise Reduction	Removes irregularly generated tiny dots for a clear picture.
MPEG Noise Reduction	Reduces the noise produced while creating digital video signals.
Black Level	Adjusts the black level of the picture to correct the brightness and contrast of the picture.
Real Cinema	Optimizes the video image for a cinematic look.
TruMotion	Displays fast-moving pictures with optimal picture quality. -Off: Turns off the TruMotion. -Smooth: displays fast-moving pictures smoothly. -Clear: displays fast-moving pictures clearly. -User: set de-judder manually. *De-judder: adjusts judder on the screen.

**NOTE**

- You can adjust advanced settings only in the **User** mode.

- **Reset:** resets the picture settings.

To set the aspect ratio,**Remote Control (SETTINGS) → Picture → Aspect Ratio**

Changes the aspect ratio to view the image in its optimal size.

- **16:9:** displays the image with a 16:9 aspect ratio.
- **Just Scan:** displays the image in the original size without cutting off the edges.
Original is available in HDMI (720p or higher) mode.
- **Set By Program:** automatically changes the aspect ratio to 4:3 or 16:9 depending on the input video signal.
- **4:3:** displays the image with a 4:3 aspect ratio.
- **Zoom:** expands the image to fit to the width of the screen. The top and bottom of the image may be cropped.
- **Cinema Zoom:** enlarges the image to have a cinemascope ratio of 2.35:1 without distortion.

**CAUTION**

- If a fixed image is displayed on the screen for a long period of time, it will be imprinted and become a permanent disfigurement on the screen. This image burn or burn-in is not covered by the warranty.
- If the aspect ratio is set to **4:3** for a long period of time, image burn may occur on the letterboxed area of the screen.
- The options may differ depending on the model.
- Depending on the input signal, the available aspect ratio may differ.
- You can select only **4:3** and **16:9** aspect ratios in HDMI1-PC/ HDMI2-PC/ DisplayPort-PC/ DVI-PC input mode.

To use the Energy Saving function

Remote Control (SETTINGS) → Picture → Energy Saving

Reduces power consumption by adjusting peak screen brightness.

- **Auto:** adjusts the brightness of the monitor according to ambient light. (This feature is available only with certain models.)
- **Off:** disables the Energy Saving mode.
- **Minimum/Medium/Maximum:** uses the Energy Saving according to the Energy Saving level specified for your monitor.
- **Screen Off:** turns off the screen. You will only hear audio. You can turn on the screen again by pressing any button on the remote control except the power button.

To use the Smart Energy Saving function

Remote Control (SETTINGS) → Picture → Smart Energy Saving

According to picture brightness, the brightness of the monitor will be adjusted automatically to save energy.

- **Off:** disables the **Smart Energy Saving** function.
- **On:** enables the **Smart Energy Saving** function.

To run a Picture Test

Remote Control (SETTINGS) → Picture → Picture Test

Run a Picture Test to check that picture signals are outputted normally, then solve any problems by selecting the relevant option on the screen. If there are no problems with the Test Picture, check connected external devices.

Sound Settings

To select a Sound Mode

Remote Control (SETTINGS) → Sound → Sound Mode

The best sound quality will be selected automatically depending on the video type currently being watched.

- **Standard:** this sound mode works well for content of all types.
- **News:** optimizes sound for watching news.
- **Music:** optimizes sound for listening to music.
- **Cinema:** optimizes sound for watching movies.
- **Sports:** optimizes sound for watching sports.
- **Game:** optimizes sound for playing videogames.

To use the Sound Effects function

Remote Control (SETTINGS) → Sound → Sound Effects

- **Clear Voice II:** enjoy clearer sound with the three-level adjustment.
- **Equalizer:** manually adjust sound by using the equalizer. .
- **Balance:** adjust the output volume for the left speaker and the right speaker.
- **Reset:** reset the sound settings.

To select a Volume Increase Rate,

Remote Control (SETTINGS) → Sound → Volume Increase Rate

you can set the volume range by selecting any of **Low/ Medium/ High**.

To sync audio with video

Remote Control (SETTINGS) → Sound → AV Sync. Adjust

- **Speaker:** adjusts the sync between video and audio coming from external speakers, such as those connected to the digital audio output port, LG audio equipment, or headphones. From the default value, the closer the value is to -, the faster the sound output becomes, and the closer the value is to +, the slower the sound output becomes.
- **Bypass:** audio coming from external devices without delay. Audio may be outputted earlier than video due to the processing time for video that is inputted into the monitor.

To Run a sound test

Remote Control (SETTINGS) → Sound → Sound Test

Run a sound test to check that sound signals are outputted normally, then solve any problems by selecting the relevant option on the screen. If there are no problems with the Sound Test, check connected external devices.

Network Settings

To Set a Signage Name

Remote Control (SETTINGS) → Network → Signage Name

You can set a name for Signage Monitor that will be used on the network by using the on-screen keyboard.

To Set Your Network

Remote Control (SETTINGS) → Network → Wired Connection (Ethernet)

- **Connecting to a wired network:** connect the display to a Local Area Network (LAN) via the LAN port as shown in the following illustration and set up the network settings. Only wired network connections are supported. After making a physical connection, a small number of networks may require the display network settings to be adjusted. For most networks, the display will automatically make a connection without any adjustments. For detailed information, contact your Internet provider or consult your router manual.

Setting a Wireless Network

Remote Control (SETTINGS) → Network → Wi-Fi Connection

If you have set the monitor up for a wireless network, you can check and connect to the available wireless Internet networks.

- **Add a Hidden Wireless Network:** If you input the name of network directly, you can add a wireless network.
- **Connect via WPS PBC:** Connects easily when the button of a wireless AP supporting PBC is pressed.
- **Connect via WPS PIN:** Connects easily when the PIN of the wireless AP that you wish to connect to is entered in to the AP configuration webpage.
- **Advanced Settings:** If you input the information of network directly, you can enter a wireless network. If there is no wireless network available, click **Advanced Settings**. You can add a network.

Tips for Network Setting

- Use a standard LAN cable (Cat5 or higher with a RJ45 connector) with this display.
- Many network connection problems during set-up can often be fixed by re-setting the router or modem. After connecting the display to the home network, quickly power off and/or disconnect the power cable of the home network router or cable modem, then power on and/or connect the power cable again.
- Depending on the Internet Service Provider (ISP), the number of devices that can receive Internet service may be limited by the applicable terms of service. For details, contact your ISP.
- LG is not responsible for any malfunction of the display and/or the Internet connection feature due to communication errors/malfunctions associated with your Internet connection, or other connected equipment.
- LG is not responsible for problems with your Internet connection.
- You may experience undesired results if the network connection speed does not meet the requirements of the content being accessed.
- Some Internet connection operations may not be possible due to certain restrictions set by the Internet Service Provider (ISP) supplying your Internet connection.
- Any fees charged by an ISP including, without limitation, connection charges are your responsibility.

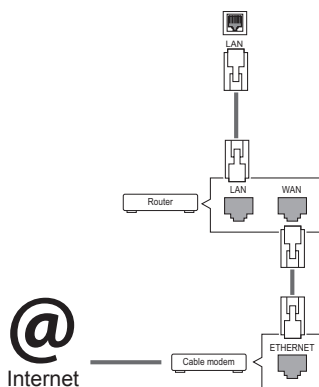

NOTE

- If you want to access the Internet directly on your display, the Internet connection should always be on.
- If you cannot access the Internet, check the network conditions from a PC on your network.
- When you use **Network Setting**, check the LAN cable or check if DHCP in the router is turned on.
- If you do not complete the network settings, the network may not function correctly.



CAUTION

- Do not connect a modular telephone cable to the LAN port.
- Since there are various connection methods, please follow the specifications of your telecommunication carrier or Internet Service Provider.
- Network Setting menu will not be available until the display is connected to a physical network.

Tips for Wireless Network Setting

- Wireless networks can be subject to interference from other devices operating at a frequency of 2.4 GHz (wireless phones, Bluetooth devices or microwave ovens). There may also be interference from devices with a frequency of 5 GHz, same as other Wi-Fi devices.
- The surrounding wireless environment can cause the wireless network service to run slowly.
- If you do not turn off the entire local home network, network traffic may occur on some devices.
- For an AP connection, an access point device that supports wireless connection is required and the wireless connection feature must be enabled on the device. Contact your service provider regarding availability of wireless connection on your access point.
- Check the SSID and security settings of the AP for AP connection. Refer to the appropriate documentation for SSID and security settings of the AP.
- Invalid settings on network devices (wired/wireless line sharer, hub) can cause the monitor to run slowly or not operate properly. Install the devices correctly according to the appropriate manual and set the network.
- Connection method may differ according to the AP manufacturer.

General Settings

To configure the language

Remote Control (SETTINGS) → General → Menu Language

Select one of the languages on the menu displayed on the screen.

- **Menu Language:** sets a language for Signage.

To set the time/date

Remote Control (SETTINGS) → General → Time & Date

You can check or change the time.

- **Time:** you can set the time manually.
- **Date:** you can set the date manually.

To turn your monitor on or off automatically

Remote Control (SETTINGS) → General → Timers

You can set the On/Off Timer for your monitor.

- **On Timer:** you can set the time when your monitor turns on.
- **Off Timer:** you can set the time when your monitor turns off.
- **No Signal Power Off (15 minutes):** If you do not press any button within 15 minutes of the monitor being turned on by the On Timer feature, the monitor turns off automatically. To ensure the monitor does not turn off automatically, set Auto Off to Off.
- **Auto Power Off (4 Hours):** If you do not press any button within four hours of the monitor being turned on, the monitor enters Standby mode automatically.



NOTE

- On Time/Off Time can be saved for up to seven schedules; the monitor is turned on or off at the preset time in the schedule list. If multiple preset times are stored in the schedule list, this function works at the nearest time from the current time.
- Once the on or off time is set, these functions operate daily at the preset time.
- The scheduled power-off function works properly only when the device time is set correctly.
- When the scheduled power-on and power-off times are the same, the power-off time has priority over the power-on time if the set is turned on, and vice versa if the set is turned off.

To reset your monitor settings

Remote Control (SETTINGS) → General → Reset to Initial Settings

Resets all monitor settings.

TROUBLESHOOTING

No image is displayed

Problem	Action
Is the product power cord connected?	<ul style="list-style-type: none"> Check if the power cord is correctly plugged into the power outlet.
Does the Out of range message appear?	<ul style="list-style-type: none"> The signal from the PC (video card) is out of the vertical or horizontal frequency range of the product. Adjust the frequency range by referring to the Specifications in this manual. * Maximum resolution: 1920 x 1080 (60Hz)
Does the Check signal cable message appear?	<ul style="list-style-type: none"> The signal cable between PC and product is not connected. Check the signal cable. Press the INPUT menu in the remote Control to check the input signal.

The Unknown Product message appears when the product is connected.

Problem	Action
Did you install the driver?	<ul style="list-style-type: none"> Check if the Plug & Play function is supported by referring to the video card user manual.

The screen image looks abnormal.

Problem	Action
Is the screen position wrong?	<ul style="list-style-type: none"> Check if the video card resolution and frequency are supported by the product. If the frequency is out of range, set to the recommended resolution in the Control Panel Display Setting menu.
The screen is displayed abnormally.	<ul style="list-style-type: none"> The proper input signal is not connected to the signal port. Connect the signal cable that matches with the source input signal.



NOTE

- The software-related contents may be changed without prior notice due to upgrade of the product functions.

After-image appears on the product.

Problem	Action
After-image appears when the product is turned off.	<ul style="list-style-type: none"> • If you use a fixed image for a long time, the pixels may be damaged. Use the screen-saver function. • When a dark image is displayed on the screen after an image with high contrast (black and white or gray), this may cause image sticking. This is normal for LCD screen products.

The audio function does not work.

Problem	Action
No sound?	<ul style="list-style-type: none"> • See if the audio cable is connected properly. • Adjust the volume. • See if the sound is set properly.
Sound is too dull.	<ul style="list-style-type: none"> • Select the appropriate equalizer sound.
Sound is too low.	<ul style="list-style-type: none"> • Adjust the volume.

Screen color is abnormal.

Problem	Action
Screen has poor color resolution (16 colors).	<ul style="list-style-type: none"> • Set the number of colors to more than 24 bits (true color). Select Control Panel - Display - Settings - Color Table menu in Windows.
Screen color is unstable or mono-colored.	<ul style="list-style-type: none"> • Check the connection status of the signal cable. Or, re-insert the PC video card.
Do black spots appear on the screen?	<ul style="list-style-type: none"> • Several pixels (red, green, white, or black color) may appear on the screen, which can be attributable to the unique characteristics of the LCD panel. This is not a malfunction of the LCD.

The operation does not work normally.



Problem	Action
The power suddenly turned off.	<ul style="list-style-type: none"> • Is the Timers set? • Check the power control settings. Power interrupted.

PRODUCT SPECIFICATIONS

32LS53A

LCD screen	Screen type	80.0 cm Thin Film Transistor (TFT) Liquid Crystal Display (LCD) Screen Diagonal length of the screen: 80.0 cm 32" class (31.5" / 80.0 cm diagonal)
	Pixel pitch	0.36375 mm (H) x 0.36375 mm (V)
Video signal	Maximum resolution	1920 x 1080 @ 60 Hz - This may not be supported on some OS or video card types.
	Recommended resolution	1920 x 1080 @ 60 Hz - This may not be supported on some OS or video card types.
	Horizontal frequency	HDMI / DVI / DisplayPort: 30 kHz to 83 kHz
	Vertical frequency	HDMI / DVI / DisplayPort: 56 Hz to 60 Hz
	Synchronization	Digital
Input ports	Audio, LAN, HDMI 1, HDMI 2, IR & Light sensor, Pixel Sensor ,DVI, DisplayPort IN , USB, RS-232C IN	
Output ports	DisplayPort OUT, RS-232C OUT, SPEAKER OUT	
Embedded battery	Applied	
Power	Rated power	AC 100-240 V~ 50/60 Hz 1.3 A
	Power consumption	On Mode: 60 W Typ Sleep Mode (DVI , HDMI): ≤ 1.0 W Sleep Mode(DisplayPort): ≤ 0.7 W Off Mode: ≤ 0.5W
Environmental Conditions	Operating Temperature	0 °C to 40 °C
	Operating Humidity	10 % to 80 %
	Storage Temperature	-20 °C to 60 °C
	Storage Humidity	5 % to 95 %

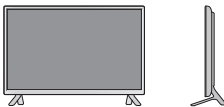
The specifications shown above may be changed without prior notice to improve quality.

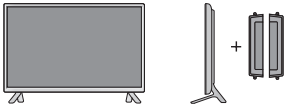
Dimensions (Width x Height x Depth) / Weight		730.9 mm x 430.1 mm x 55.5 mm / 5.9 kg
		730.9 mm x 480.2 mm x 207 mm / 6.1 kg
		730.9 mm x 430.1 mm x 105.1 mm / 6.7 kg
		730.9 mm x 480.2 mm x 207 mm / 6.9 kg

*** Applicable only for models that support the speakers**



Audio	RMS Audio Output	10 W + 10 W (R + L)
	Input Sensitivity	0.7 Vrms
	Speaker Impedance	8 Ω

The specifications shown above may be changed without prior notice to improve quality.

42LS55A 42LS53A

LCD screen	Screen type	106.4 cm Thin Film Transistor (TFT) Liquid Crystal Display (LCD) Screen Diagonal length of the screen: 106.4 cm 42" class (41.9" / 106.4 cm diagonal)
	Pixel pitch	0.4833 mm (H) x 0.4833 mm (V)
Video signal	Maximum resolution	1920 x 1080 @ 60 Hz - This may not be supported on some OS or video card types.
	Recommended resolution	1920 x 1080 @ 60 Hz - This may not be supported on some OS or video card types.
	Horizontal frequency	HDMI / DVI / DisplayPort: 30 kHz to 83 kHz
	Vertical frequency	HDMI / DVI / DisplayPort: 56 Hz to 60 Hz
	Synchronization	Digital
Input ports	Audio, LAN, HDMI 1, HDMI 2, IR & Light sensor, Pixel Sensor ,DVI, DisplayPort IN , USB, RS-232C IN	
Output ports	DisplayPort OUT, RS-232C OUT, SPEAKER OUT	
Embedded battery	Applied	
Power	Rated power	AC 100-240 V~ 50/60 Hz 1.2 A
	Power consumption	On Mode: 90 W Typ Sleep Mode (DVI , HDMI): ≤ 1.0W Sleep Mode(DisplayPort): ≤ 0.7W Off Mode: ≤ 0.5W
Environmental Conditions	Operating Temperature	0 °C to 40 °C
	Operating Humidity	10 % to 80 %
	Storage Temperature	-20 °C to 60 °C
	Storage Humidity	5 % to 95 %

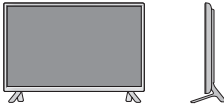
The specifications shown above may be changed without prior notice to improve quality.

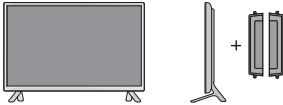
Dimensions (Width x Height x Depth) / Weight		
		959.5 mm x 559 mm x 55.5 mm / 9.1 kg
		
		959.5 mm x 610.8 mm x 218 mm / 9.3 kg
		
	959.5 mm x 559 mm x 91 mm / 9.9 kg	
		
	959.5 mm x 610.8 mm x 218 mm / 10.1 kg	

*** Applicable only for models that support the speakers**

Audio	RMS Audio Output	10 W + 10 W (R + L)
	Input Sensitivity	0.7 Vrms
	Speaker Impedance	8 Ω



The specifications shown above may be changed without prior notice to improve quality.

47LS55A

47LS53A

LCD screen	Screen type	119.2 cm Thin Film Transistor (TFT) Liquid Crystal Display (LCD) Screen Diagonal length of the screen: 119.2 cm 47" class (46.9" / 119.2 cm diagonal)
	Pixel pitch	0.5415 mm (H) x 0.5415 mm (V)
Video signal	Maximum resolution	1920 x 1080 @ 60 Hz - This may not be supported on some OS or video card types.
	Recommended resolution	1920 x 1080 @ 60 Hz - This may not be supported on some OS or video card types.
	Horizontal frequency	HDMI / DVI / DisplayPort: 30 kHz to 83 kHz
	Vertical frequency	HDMI / DVI / DisplayPort: 56 Hz to 60 Hz
	Synchronization	Digital
Input ports	Audio, LAN, HDMI 1, HDMI 2, IR & Light sensor, Pixel Sensor ,DVI, DisplayPort IN , USB, RS-232C IN	
Output ports	DisplayPort OUT, RS-232C OUT, SPEAKER OUT	
Embedded battery	Applied	
Power	Rated power	AC 100-240 V~ 50/60 Hz 1.3 A
	Power consumption	On Mode: 95 W Typ Sleep Mode (DVI , HDMI): ≤ 1.0 W Sleep Mode(DisplayPort): ≤ 0.7 W Off Mode: ≤ 0.5W
Environmental Conditions	Operating Temperature	0 °C to 40 °C
	Operating Humidity	10 % to 80 %
	Storage Temperature	-20 °C to 60 °C
	Storage Humidity	5 % to 95 %

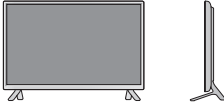
The specifications shown above may be changed without prior notice to improve quality.

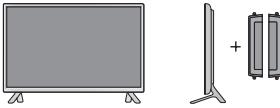
Dimensions (Width x Height x Depth) / Weight		
	1071 mm x 621.6 mm x 55.8 mm / 12.2 kg	
		
	1071 mm x 675.1 mm x 247 mm / 12.5 kg	
		
1071 mm x 621.6 mm x 90.4 mm / 13.0 kg		
		
1071 mm x 675.1 mm x 247 mm / 13.3 kg		

*** Applicable only for models that support the speakers**



Audio	RMS Audio Output	10 W + 10 W (R + L)
	Input Sensitivity	0.7 Vrms
	Speaker Impedance	8 Ω

The specifications shown above may be changed without prior notice to improve quality.

55LS55A	55LS53A
---------	---------

LCD screen	Screen type	138.7 cm Thin Film Transistor (TFT) Liquid Crystal Display (LCD) Screen Diagonal length of the screen: 138.7 cm 55" class (54.6" / 138.7 cm diagonal)
	Pixel pitch	0.630 mm (H) x 0.630 mm (V)
Video signal	Maximum resolution	1920 x 1080 @ 60 Hz - This may not be supported on some OS or video card types.
	Recommended resolution	1920 x 1080 @ 60 Hz - This may not be supported on some OS or video card types.
	Horizontal frequency	HDMI / DVI / DisplayPort: 30 kHz to 83 kHz
	Vertical frequency	HDMI / DVI / DisplayPort: 56 Hz to 60 Hz
	Synchronization	Digital
Input ports		Audio, LAN, HDMI 1, HDMI 2, IR & Light sensor, Pixel Sensor ,DVI, DisplayPort IN , USB, RS-232C IN
Output ports		DisplayPort OUT, RS-232C OUT, SPEAKER OUT
Embedded battery		Applied
Power	Rated power	AC 100-240 V~ 50/60 Hz 1.5 A
	Power consumption	
	55LS55A	On Mode: 120 W Typ Sleep Mode (DVI , HDMI): ≤ 1.0 W Sleep Mode(DisplayPort): ≤ 0.7 W Off Mode: ≤ 0.5W
	55LS53A	On Mode: 110 W Typ Sleep Mode (DVI , HDMI): ≤ 1.0 W Sleep Mode(DisplayPort): ≤ 0.7 W Off Mode: ≤ 0.5W
Environmental Conditions	Operating Temperature	0 °C to 40 °C
	Operating Humidity	10 % to 80 %
	Storage Temperature	-20 °C to 60 °C
	Storage Humidity	5 % to 95 %

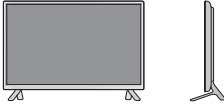
The specifications shown above may be changed without prior notice to improve quality.

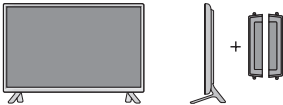
Dimensions (Width x Height x Depth) / Weight		
	1240.9 mm x 717.2 mm x 56.8 mm / 17.8 kg	
		
	1240.9 mm x 770.8 mm x 247 mm / 18.1 kg	
		
1240.9 mm x 717.2 mm x 91.4 mm / 18.6 kg		
		
1240.9 mm x 770.8 mm x 247 mm / 18.9 kg		

*** Applicable only for models that support the speakers**



Audio	RMS Audio Output	10 W + 10 W (R + L)
	Input Sensitivity	0.7 Vrms
	Speaker Impedance	8 Ω

The specifications shown above may be changed without prior notice to improve quality.

65LS53A

LCD screen	Screen type	163.8 cm Thin Film Transistor (TFT) Liquid Crystal Display (LCD) Screen Diagonal length of the screen: 163.8 cm 65" class (64.5" /163.8 cm diagonal)
	Pixel pitch	0.744 mm (H) x 0.744 mm (V)
Video signal	Maximum resolution	1920 x 1080 @ 60 Hz - This may not be supported on some OS or video card types.
	Recommended resolution	1920 x 1080 @ 60 Hz - This may not be supported on some OS or video card types.
	Horizontal frequency	HDMI / DVI / DisplayPort: 30 kHz to 83 kHz
	Vertical frequency	HDMI / DVI / DisplayPort: 56 Hz to 60 Hz
	Synchronization	Digital
Input ports		Audio, LAN, HDMI 1, HDMI 2, IR & Light sensor, Pixel Sensor ,DVI, DisplayPort IN , USB, RS-232C IN
Output ports		DisplayPort OUT, RS-232C OUT, SPEAKER OUT
Embedded battery		Applied
Power	Rated power	AC 100-240 V~ 50/60 Hz 2.0 A
	Power consumption	On Mode: 165 W Typ Sleep Mode (DVI , HDMI): ≤ 1.0 W Sleep Mode(DisplayPort): ≤ 0.7 W Off Mode: ≤ 0.5W
Environmental Conditions	Operating Temperature	0 °C to 40 °C
	Operating Humidity	10 % to 80 %
	Storage Temperature	-20 °C to 60 °C
	Storage Humidity	5 % to 95 %

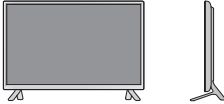
The specifications shown above may be changed without prior notice to improve quality.

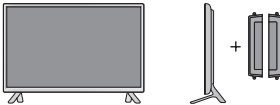
Dimensions (Width x Height x Depth) / Weight		1461.6 mm x 843 mm x 57.6 mm / 30.9 kg
		1461.6 mm x 900.6 mm x 313 mm / 32.3 kg
		1461.6 mm x 843 mm x 92.6 mm / 31.7 kg
		1461.6 mm x 900.6 mm x 313 mm / 33.1 kg

*** Applicable only for models that support the speakers**

Audio	RMS Audio Output	10 W + 10 W (R + L)
	Input Sensitivity	0.7 Vrms
	Speaker Impedance	8 Ω

The specifications shown above may be changed without prior notice to improve quality.

Product Dimensions

The illustrations in this manual may differ from the actual product and accessories.
Please see “**Mounting on a wall**” section for screw sizes.

32LS53A

(Unit: mm)

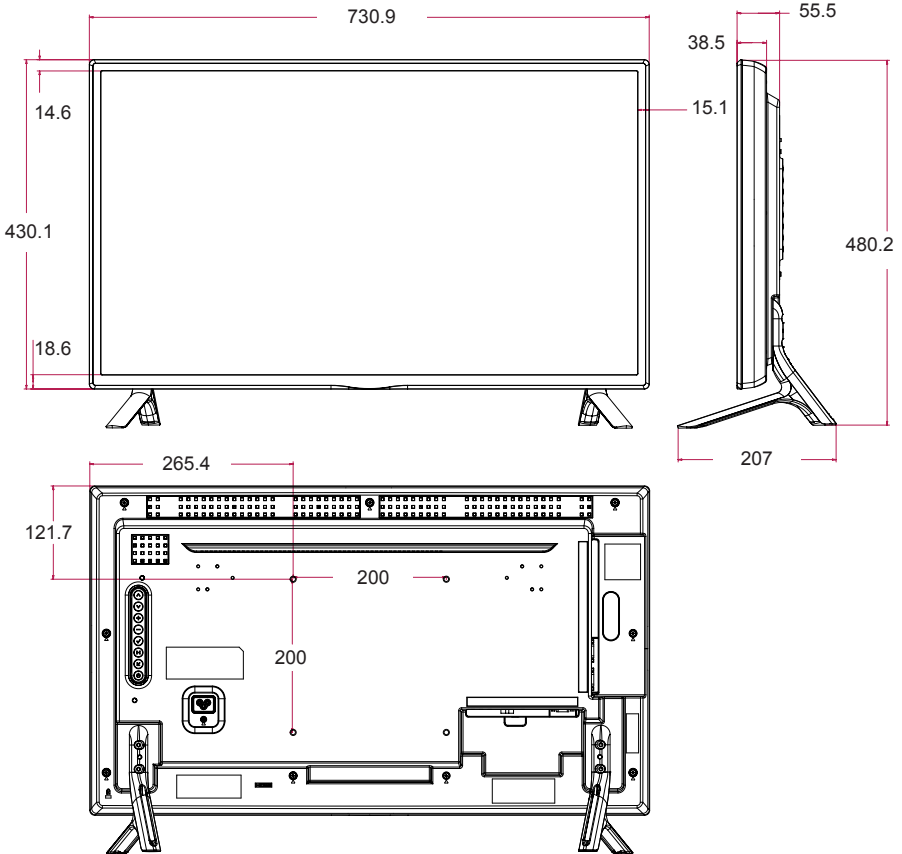

The specifications shown above may be changed without prior notice to improve quality.

Product Dimensions

The illustrations in this manual may differ from the actual product and accessories.
Please see “**Mounting on a wall**” section for screw sizes.

42LS55A 42LS53A

(Unit: mm)

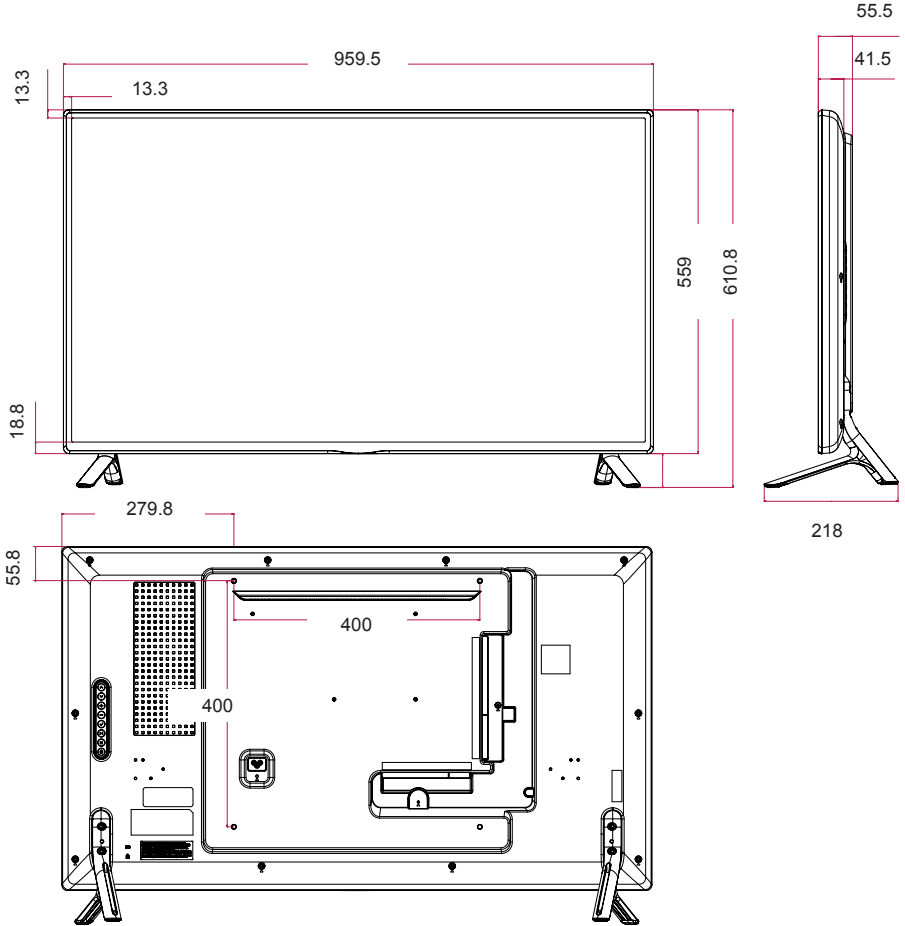

The specifications shown above may be changed without prior notice to improve quality.

Product Dimensions

The illustrations in this manual may differ from the actual product and accessories.
Please see “**Mounting on a wall**” section for screw sizes.

47LS55A 47LS53A

(Unit: mm)

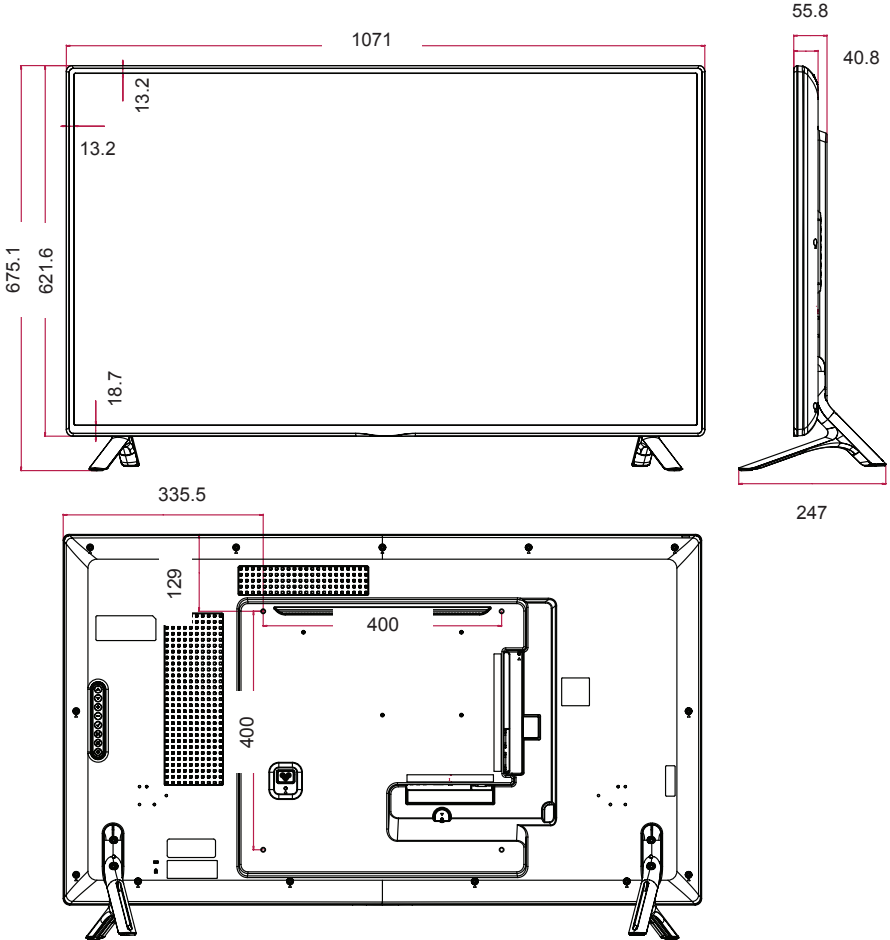

The specifications shown above may be changed without prior notice to improve quality.

Product Dimensions

The illustrations in this manual may differ from the actual product and accessories.
Please see “**Mounting on a wall**” section for screw sizes.

(Unit: mm)

55LS55A 55LS53A

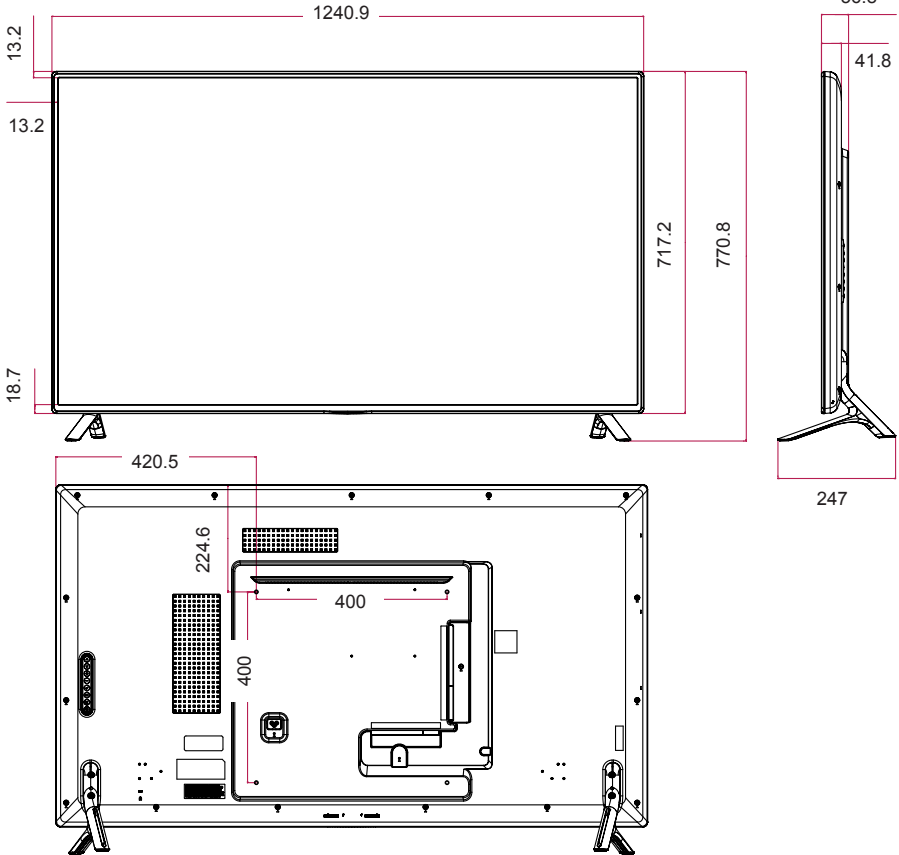

The specifications shown above may be changed without prior notice to improve quality.

Product Dimensions

The illustrations in this manual may differ from the actual product and accessories.
Please see “**Mounting on a wall**” section for screw sizes.

(Unit: mm)

65LS53A

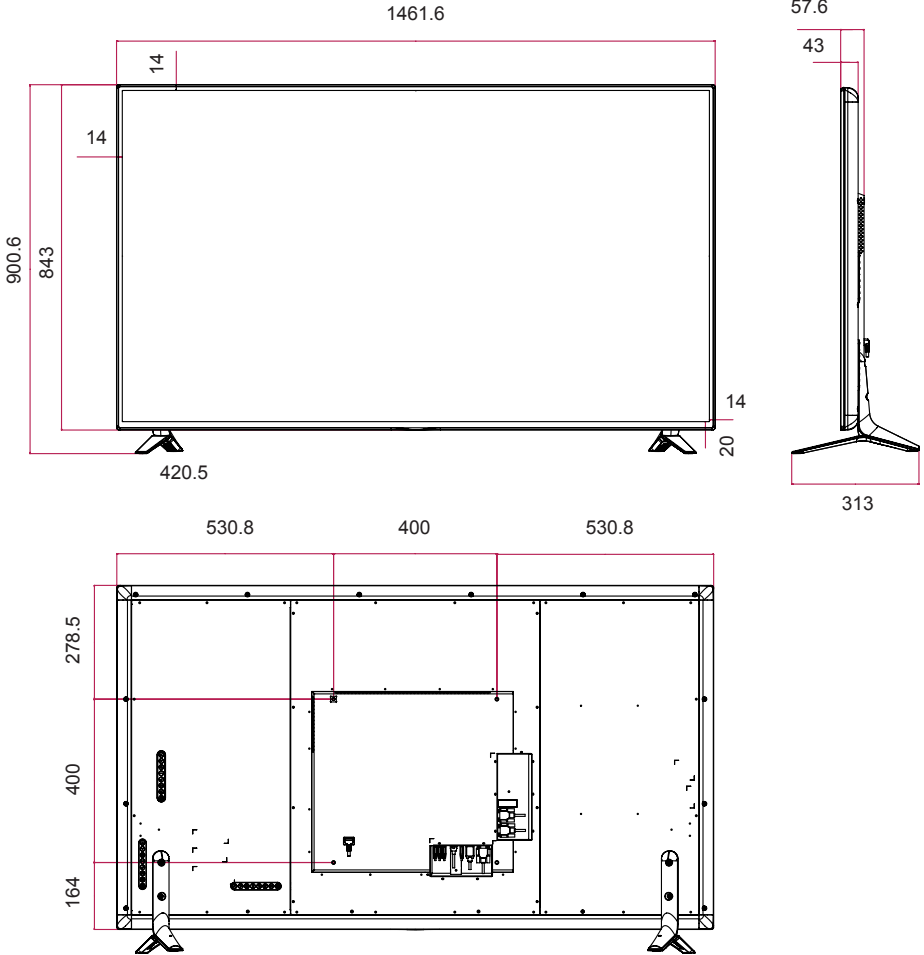

The specifications shown above may be changed without prior notice to improve quality.

HDMI / DVI / DisplayPort (PC) Support Mode

Resolution	Horizontal frequency (kHz)	Vertical frequency (Hz)
640 x 480	31.469	59.94
800 x 600	37.879	60.317
1024 x 768	48.363	60
1280 x 720	44.772	59.855
1366 x 768	47.7	60
1280 x 1024	63.981	60.02
1680 x 1050	65.290	59.954
1920 x 1080	67.5	60

DTV mode

Resolution	HDMI / DisplayPort (DTV)
480i	x
576i	x
480p	o
576p	o
720p	o
1080i	o
1080p	o

NOTE











- PC resolutions available for the Input Label option in HDMI/DVI/DisplayPort input modes: 640 x 480/60 Hz, 1280 x 720/60 Hz, 1920 x 1080/60 Hz; 480p, 720p, and 1080p DTV resolutions.

NOTE

- Vertical frequency: The product display functions by the screen image changing dozens of times every second like a fluorescent lamp. The vertical frequency or refresh rate is the number of image displays per second. The unit is Hz.
- Horizontal frequency: The horizontal interval is the time taken to display one horizontal line. When 1 is divided by the horizontal interval, the number of horizontal lines displayed every second can be tabulated as the horizontal frequency. The unit is kHz.

IR CODES

All models do not support the HDMI/USB function.
Some key codes may not be supported depending on the model.

Code (Hex)	Function	Remarks
08	 POWER	Remote control button
C4	MONITOR ON	Remote control button
C5	MONITOR OFF	Remote control button
95	Energy Saving	Remote control button
0B	INPUT	Remote control button
10	Number Key 0	Remote control button
11	Number Key 1	Remote control button
12	Number Key 2	Remote control button
13	Number Key 3	Remote control button
14	Number Key 4	Remote control button
15	Number Key 5	Remote control button
16	Number Key 6	Remote control button
17	Number Key 7	Remote control button
18	Number Key 8	Remote control button
19	Number Key 9	Remote control button
02	Volume  (+)	Remote control button
03	Volume  (-)	Remote control button
E0	BRIGHTNESS  (Page Up)	Remote control button
E1	BRIGHTNESS  (Page Down)	Remote control button
DC	3D	Remote control button
32	1/a/A	Remote control button
2F	CLEAR	Remote control button
7E	 SIMPLINK	Remote control button
79	ARC(MARK) (Aspect Ratio)	Remote control button
4D	PSM (Picture Mode)	Remote control button
09	MUTE	Remote control button
43	SETTINGS (Menu)	Remote control button
99	Auto Config.	Remote control button
40	Up 	Remote control button
41	Down 	Remote control button
06	Right 	Remote control button
07	Left 	Remote control button
44	OK	Remote control button
28	BACK	Remote control button

Code (Hex)	Function	Remarks
7B	TILE	Remote control button
5B	EXIT	Remote control button
72	ID ON (RED)	Remote control button
71	ID OFF (GREEN)	Remote control button
63	YELLOW	Remote control Button
61	BLUE	Remote control button
B1	■	Remote control button
B0	▶	Remote control button
BA		Remote control button
8F	◀◀	Remote control button
8E	▶▶	Remote control button
5F	W.BAL	Remote control button
3F	S.MENU	Remote control button
7C	HOME	Remote control button

TO CONTROL MULTIPLE PRODUCTS

Use this method to connect several products to a single PC. You can control several products at a time by connecting them to a single PC.

In the Option menu, the Set ID must be between 1 and 255 without being duplicated.

Connecting the cable

Connect the RS-232C cable as shown in the picture.

The RS-232C protocol is used for communication between the PC and product. You can turn the product on or off, select an input source or adjust the OSD menu from your PC.

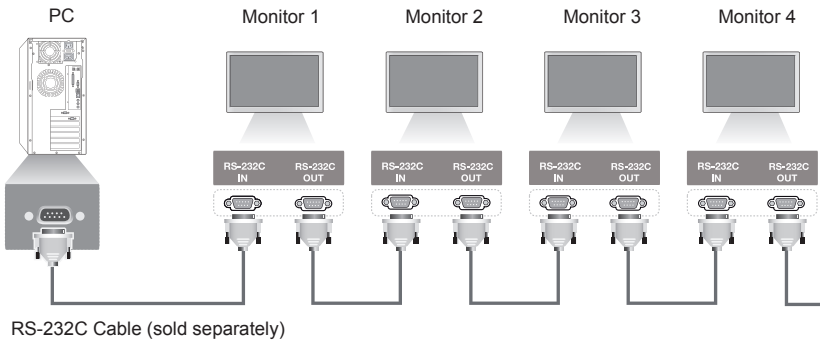

RS-232C Configurations

8-Wire Configurations (Standard RS-232C cable)

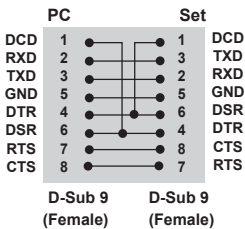

Communication Parameter

Baud Rate: 9600 BPS

Data Length: 8 bit

Parity Bit: None

Stop Bit: 1 bit

Flow Control: None

Communication Code: ASCII code

Use a crossed (reverse) cable

NOTE

- When using three-wire connections (non-standard), an IR daisy chain cannot be used.

NOTE

- When monitors connected via Daisy Chain (that controls multiple monitors) are turned off and on successively, some monitors may not turn on. In this case, you can turn those monitors on by pressing the **MONITOR ON** button, not the **POWER** button.

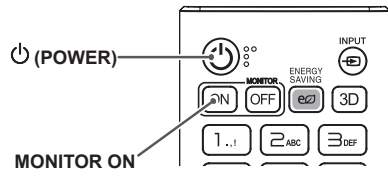

Command Reference List

		COMMAND		DATA (Hexadecimal)
		1	2	
01	Power	k	a	00 to 01
02	Select input	x	b	See Select Input
03	Aspect Ratio	k	c	See Aspect Ratio
04	Energy Saving	j	q	See Energy Saving
05	Picture Mode	d	x	See Picture Mode
06	Contrast	k	g	00 to 64
07	Brightness	k	h	00 to 64
08	Sharpness	k	k	00 to 32
09	Color	k	i	00 to 64
10	Tint	k	j	00 to 64
11	Color temperature	x	u	00 to 64
12	Balance	k	t	00 to 64
13	Sound Mode	d	y	See Sound Mode
14	Mute	k	e	00 to 01
15	Volume Control	k	f	00 to 64
16	Time 1 (year/month/day)	f	a	See Time 1
17	Time 2 (hour/minute/second)	f	x	See Time 2
18	Off time schedule	f	c	00 to 01
19	On Time Schedule	f	b	00 to 01
20	Off Timer (Repeat/Time)	f	e	See Off Timer
21	On Timer (Repeat/Time)	f	d	See On Timer
22	On Timer Input	f	u	Refer to On Timer Input.
23	No Signal Power Off (15Min)	f	g	00 to 01
24	Auto Power Off (4 Hours)	m	n	00 to 01
25	Language	f	i	See Language
26	Reset	f	k	00, 02
27	Current Temperature	d	n	FF
28	Key	m	c	See Key
29	Time Elapsed	d	l	FF
30	Product Serial Number	f	y	FF
31	Software Version	f	z	FF
32	White Balance Red Gain	j	m	00 to FE
33	White Balance Green Gain	j	n	00 to FE

		COMMAND		DATA (Hexadecimal)
		1	2	
34	White Balance Blue Gain	j	o	00 to FE
35	White Balance Red Offset	s	x	00 to FE
36	White Balance Green Offset	s	y	00 to FE
37	White Balance Blue Offset	s	z	00 to FE
38	Backlight	m	g	00 to 64
39	Screen off	k	d	00 to 01
40	Tile Mode	d	d	00 to FF
41	Check Tile Mode	d	z	FF
42	Tile ID	d	i	See Tile ID
43	Natural Mode	d	j	00 to 01
44	DPM Select	f	j	00 to 07
45	Remote Control/Local Key Lock	k	m	00 to 01
46	Power On Delay	f	h	00 to 64
47	Fail Over Select	m	i	00 to 02
48	Fail Over Input Select	m	j	See Fail Over Input Select
49	IR Operation	t	p	00 to 02
50	Local Key Operation	t	o	00 to 02
51	Check the status	s	v	See Check the status
52	Check Screen	t	z	00 to 01
53	Speakers	d	v	00 to 01

* Note: Only the power and key commands can be used while media files are playing from a USB device or internal/external memory. The commands other than the power and key commands will be treated as NG. Some commands may not be supported depending on the model.

Transmission/Reception Protocol

Transmission

[Command1][Command2][][Set ID][][Data][Cr]

- * [Command1]: identifies between the factory setting and the user setting modes.
- * [Command2]: controls monitor sets.
- * [Set ID]: Used for selecting a set you want to control. A unique Set ID can be assigned to each set ranging from 1 to 255 (01H~FFH) under Settings in the OSD menu.
 Selecting '00H' for Set ID allows the simultaneous control of all connected monitors.
- * [Data]: Transmits command data.
 Data count may increase depending on the command.
- * [Cr]: Carriage Return. Corresponds to '0x0D' in ASCII code.
- * []: White Space. Corresponds to '0x20' in ASCII code.

Acknowledgement

[Command2][][Set ID][][OK/NG][Data][x]

- * The Product transmits ACK (acknowledgement) based on this format when receiving normal data. At this time, if the data is FF, it indicates the present status data. If the data is in data write mode, it returns the data of the PC computer.
- * If a command is sent with Set ID '00' (=0x00), the data is reflected to all monitor sets and each monitor set does not send an acknowledgement (ACK).
- * If the data value 'FF' is sent in control mode via RS-232C, the current setting value of a function can be checked (only for some functions).
- * Some commands are not supported depending on the model.

01. Power (Command: k a)

Controls the power on/off of the set.

Transmission

[k][a][][Set ID][][Data][Cr]

Data 00: Off
01: On

Acknowledgement

[a][][Set ID][][OK/NG][Data][x]

*The acknowledgement signal is returned properly only when the monitor is fully powered on.

* There may be a delay between the transmission and acknowledgement signals.

04. Energy Saving (Command: j q)

Sets the Energy Saving.

Transmission

[j][q][][Set ID][][Data][Cr]

Data 00: Off
01: Minimum
02: Medium
03: Maximum
04: Automatic
05: Screen off

Acknowledgement

[q][][Set ID][][OK/NG][Data][x]

** This may not be supported depending on the model.

02. Select Input (Command: x b)

Selects an input signal.

Transmission

[x][b][][Set ID][][Data][Cr]

Data 70: DVI (PC)
80: DVI (DTV)
90: HDMI1 (DTV)
A0: HDMI1 (PC)
91: HDMI2 (DTV)
A1: HDMI2 (PC)
C0: DisplayPort (DTV)
D0: DisplayPort (PC)

Acknowledgement

[b][][Set ID][][OK/NG][Data][x]

* Some input signals may not be supported depending on the model.

05. Picture Mode (Command: d x)

Selects a picture mode.

Transmission

[d][x][][Set ID][][Data][Cr]

Data 00: Vivid
01: Standard
02: Cinema
03: Sports
04: Game
05: Expert 1
06: Expert 2
08: APS

Acknowledgement

[x][][Set ID][][OK/NG][Data][x]

03. Aspect Ratio (Command: k c)

Adjusts the aspect ratio.

Transmission

[k][c][][Set ID][][Data][Cr]

Data 01: 4:3
02: 16:9
04: Zoom
06: Set by Program
09: Just Scan (720p or higher)
10 to 1F: Cinema Zoom 1 to 16

* Available data types differ depending on the input signal. For more information, see the aspect ratio section of the owner's manual.

* The aspect ratio may differ depending on the model's input configuration.

Acknowledgement

[c][][Set ID][][OK/NG][Data][x]

06. Contrast (Command: k g)

Adjusts the screen contrast.

Transmission

[k][g][][Set ID][][Data][Cr]

Data 00 to 64: Contrast 0 to 100

Acknowledgement

[g][][Set ID][][OK/NG][Data][x]

07. Brightness (Command: k h)

Adjusts the screen brightness.

Transmission

[k][h][][Set ID][][Data][Cr]

Data 00 to 64: Brightness 0 to 100

Acknowledgement

[h][][Set ID][][OK/NG][Data][x]

08. Sharpness (Command: k s)

Adjusts the screen sharpness.

Transmission

[k][s][][Set ID][][Data][Cr]

Data 00 to 32: Sharpness 0 to 50

Acknowledgement

[s][][Set ID][][OK/NG][Data][x]

09. Color (Command: k i)

Adjusts the screen color.

Transmission

[k][i][][Set ID][][Data][Cr]

Data 00 to 64: Color 0 to 100

Acknowledgement

[i][][Set ID][][OK/NG][Data][x]

10. Tint (Command: k j)

Adjusts the screen tint.

Transmission

[k][j][][Set ID][][Data][Cr]

Data 00 to 64: Tint red 50 to green 50

Acknowledgement

[j][][Set ID][][OK/NG][Data][x]

11. Color Temperature (Command: x u)

Adjusts the screen color temperature.

Transmission

[x][u][][Set ID][][Data][Cr]

Data 00 to 64: warm 50 to cool 50

Acknowledgement

[u][][Set ID][][OK/NG][Data][x]

12. Balance (Command: k t)

Adjusts the sound balance.

Transmission

[k][t][][Set ID][][Data][Cr]

Data 00 to 64: left 50 to right 50

Acknowledgement

[t][][Set ID][][OK/NG][Data][x]

13. Sound mode (Command: d y)

Selects a sound mode.

Transmission

[d][y][][Set ID][][Data][Cr]

Data 01: Standard
 02: Music
 03: Cinema
 04: Sports
 05: Game
 07: News

Acknowledgement

[y][][Set ID][][OK/NG][Data][x]

14. Mute (Command: k e)

Mutes/unmutes the sound.

Transmission

[k][e][][Set ID][][Data][Cr]

Data 00: Mute
 01: Unmute

Acknowledgement

[e][][Set ID][][OK/NG][Data][x]

15. Volume Control (Command: k f)

Adjusts the playback volume.

Transmission

[k][f][][Set ID][][Data][Cr]

Data 00 to 64: Volume 0 to 100

Acknowledgement

[f][][Set ID][][OK/NG][Data][x]

16. Time 1 (year/month/day) (Command: f a)

Adjusts the Time 1 (year/month/day) value.

Transmission

[f][a][][Set ID][][Data1][][Data2][][Data3][Cr]

Data1 04~1B: year 2014 to 2037
 Data2 01 to 0C: January to December
 Data3 01 to 1F: 1st to 31st

* Enter "fa [Set ID] ff" to view the Time 1 (year/month/day) settings.

Acknowledgement

[a][][Set ID][][OK/NG][Data1][Data2][Data3][x]

17. Time 2 (hour/minute/second) (Command: f x)

Adjusts the Time 2 (hour/minute/second) value.

Transmission

[f][x][][Set ID][][Data1][][Data2][][Data3][Cr]

Data1 00 to 17: 00 to 23 hours
 Data2 00 to 3B: 00 to 59 minutes
 Data3 00 to 3B: 00 to 59 seconds

* Enter "fx [Set ID] ff" to view the Time 2 (hour/minute/second) settings.

** This function is only available when Time 1 (year/month/day) is set.

Acknowledgement

[x][][Set ID][][OK/NG][Data1][Data2][Data3][x]

18. Off Time Schedule (Command: f c)

Enables/disables the Off Time Schedule.

Transmission

[f][c][][Set ID][][Data][Cr]

Data 00: Off

01: On

Acknowledgement

[c][][Set ID][][OK/NG][Data][x]

19. On Time Schedule (Command: f b)

Enables/disables the On Time schedule.

Transmission

[f][b][][Set ID][][Data][Cr]

Data 00: Off

01: On

Acknowledgement

[b][][Set ID][][OK/NG][Data][x]

20. Off Timer (Repeat/Time) (Command: f e)

Configures Off Timer (Repeat/Time) settings.

Transmission**[f][e][][Set ID][][Data1][][Data2][][Data3][Cr]**

Data1

1. f1h to f7h (reading data)

F1: reads the 1st Off Timer data

F2: reads the 2nd Off Timer data

F3: reads the 3rd Off Timer data

F4: reads the 4th Off Timer data

F5: reads the 5th Off Timer data

F6: reads the 6th Off Timer data

F7: reads the 7th Off Timer data

2. e1h-e7h (delete one index), e0h (delete all indexes)

E0: erases all Off Timer settings

E1: erases the 1st Off Timer setting

E2: erases the 2nd Off Timer setting

E3: erases the 3rd Off Timer setting

E4: erases the 4th Off Timer setting

E5: erases the 5th Off Timer setting

E6: erases the 6th Off Timer setting

E7: erases the 7th Off Timer setting

3. 01h to 0Ch (sets the day of the week for the Off Timer)

01: Once

02: Daily

03: Mon - Fri

04: Mon - Sat

05: Sat - Sun

06: Every Sunday

07: Every Monday

08: Every Tuesday

09: Every Wednesday

0A: Every Thursday

0B: Every Friday

0C: Every Saturday

Data2 00 to 17: 00 to 23 hours

Data3 00 to 3B: 00 to 59 minutes

* To read or delete the Off Time Schedule list, [Data2]

[Data3] must be set to FFH.

Example 1: fe 01 f1 ff ff - reads the first index data in Off Timer.

Example 2: fe 01 e1 ff ff - deletes the first index data from Off Timer.

Example 3: fe 01 04 02 03 - sets Off Timer to 02:03 from Monday to Saturday.

* This function is only available when Time 1 (year/month/day) and Time 2 (hour/minute/second) are set.

Acknowledgement**[e][][Set ID][][OK/NG][Data1][Data2][Data3][x]****21. On timer (Repeat/Time) (Command: f d)**

Configures On Timer (Repeat/Time) settings.

Transmission**[f][d][][Set ID][][Data1][][Data2][][Data3][Cr]**

Data1

1. f1h to f7h (reading data)

F1: reads the 1st On Timer data

F2: reads the 2nd On Timer data

F3: reads the 3rd On Timer data

F4: reads the 4th On Timer data

F5: reads the 5th On Timer data

F6: reads the 6th On Timer data

F7: reads the 7th On Timer data

2. e1h-e7h (delete one index), e0h (delete all indexes)

E0: erases all On Timer settings

E1: erases the 1st On Timer setting

E2: erases the 2nd On Timer setting

E3: erases the 3rd On Timer setting

E4: erases the 4th On Timer setting

E5: erases the 5th On Timer setting

E6: erases the 6th On Timer setting

E7: erases the 7th On Timer setting

3. 01h to 0Ch (sets the day of the week for the On Timer)

01: Once

02: Daily

03: Mon - Fri

04: Mon - Sat

05: Sat - Sun

06: Every Sunday

07: Every Monday

08: Every Tuesday

09: Every Wednesday

0A: Every Thursday

0B: Every Friday

0C: Every Saturday

Data2 00 to 17: 00 to 23 hours

Data3 00 to 3B: 00 to 59 minutes

* To read or delete an On Time schedule list, [Data2][Data3] must be set to FFH.

Example 1: fd 01 f1 ff ff - reads the first index data from On Timer.

Example 2: fd 01 e1 ff ff - deletes the first index data from On Timer.

Example 3: fd 01 04 02 03 - sets On Timer to 02:03 from Monday to Saturday.

* This function is only available when Time 1 (year/month/day) and Time 2 (hour/minute/second) are set.

Acknowledgement**[d][][Set ID][][OK/NG][Data1][Data2][Data3][x]**

22. On Timer Input (Command: f u)

Select an external input for the current On Time setting and add a new schedule.

Transmission

```
[f][u][ ][Set ID][ ][Data1][Cr]
```

```
[f][u][ ][Set ID][ ][Data1][ ][Data2][Cr]
```

Data (Add schedule)

70: DVI

90: HDMI1 (DTV)

91: HDMI2 (DTV)

C0: Display Port (DTV)

Data1 (Read schedule)

1. f1h to f7h (Read data)

F1: Select the 1st schedule input

F2: Select the 2nd schedule input

F3: Select the 3rd schedule input

F4: Select the 4th schedule input

F5: Select the 5th schedule input

F6: Select the 6th schedule input

F7: Select the 7th schedule input

Data2 (Read schedule)

FF

* To read the schedule input, enter FF for [Data2].

If no schedule is available for [Data1] when attempting to read the schedule data, the text 'NG' will be displayed and the operation will fail.

(Example 1: fu 01 90 - Move each schedule input down one row and save the 1st schedule input in HDMI mode.)

(Example 2: fu 01 f1 ff - Read the 1st schedule input.)

* This function is supported only when 1 (Year/Month/Day), 2 (Hour/Minute/Second), On Time (Repeat Mode/Time) are set.

** It may not be supported depending on the model.

Acknowledgement

```
[u][ ][Set ID][ ][OK/NG][Data][x]
```

```
[u][ ][Set ID][ ][OK/NG][Data1][Data2][x]
```

23. No Signal Power Off (15Min) (Command: f g)

Configures the automatic standby settings.

Transmission

```
[f][g][ ][Set ID][ ][Data][Cr]
```

Data 00: Off

01: On

Acknowledgement

```
[g][ ][Set ID][ ][OK/NG][Data][x]
```

24. Auto Power Off (4 Hours) (Command: m n)

Configures the automatic off settings.

Transmission

```
[m][n][ ][Set ID][ ][Data][Cr]
```

Data 00: Off

01: 4 hours

Acknowledgement

```
[n][ ][Set ID][ ][OK/NG][Data][x]
```

25. Language (Command: f i)

Sets the OSD language.

Transmission

```
[f][i][ ][Set ID][ ][Data][Cr]
```

Data 00: Czech

01: Danish

02: German

03: English

04: Spanish (Europe)

05: Greek

06: French

07: Italian

08: Dutch

09: Norwegian

0A: Portuguese

0B: Portuguese (Brazil)

0C: Russian

0D: Finnish

0E: Swedish

0F: Korean

10: Chinese (Cantonese)

11: Japanese

12: Chinese (Mandarin)

Acknowledgement

```
[i][ ][Set ID][ ][OK/NG][Data][x]
```

26. Reset (Command: f k)

Performs the Picture and Factory Reset functions.

Transmission

[f][k][][Set ID][][Data][Cr]

Data 00: Picture Reset
02: Initial Settings (factory reset)

Acknowledgement

[k][][Set ID][][OK/NG][Data][x]

27. Current temperature (Command: d n)

Checks the inside temperature.

Transmission

[d][n][][Set ID][][Data][Cr]

Data FF: Check the status

Acknowledgement

[n][][Set ID][][OK/NG][Data][x]

* Temperature is displayed as a hexadecimal value.

28. Key (Command: m c)

Sends a key code for the IR remote control.

Transmission

[m][c][][Set ID][][Data][Cr]

Data IR_KEY_CODE

Acknowledgement

[c][][Set ID][][OK/NG][Data][x]

For key codes, see IR Codes.

* Some key codes are not supported depending on the model.

29. Time Elapsed (Command: d l)

Checks the elapsed time.

Transmission

[d][l][][Set ID][][Data][Cr]

Data FF: Read status

Acknowledgement

[l][][Set ID][][OK/NG][Data][x]

* The data received is shown as a hexadecimal value.

30. Product serial number (Command: f y)

Checks the serial number of the product.

Transmission

[f][y][][Set ID][][Data][Cr]

Data FF: Check product serial number

Acknowledgement

[y][][Set ID][][OK/NG][Data][x]

* Data is in ASCII code.

31. Software Version (Command: f z)

Checks the software version of the product.

Transmission

[f][z][][Set ID][][Data][Cr]

Data FF: Check software version

Acknowledgement

[z][][Set ID][][OK/NG][Data][x]

32. White balance red gain (Command: j m)

Adjusts the white balance red gain value.

Transmission

[j][m][][Set ID][][Data][Cr]

Data 00 to FE: Red Gain 0 to 254
FF: checks the red gain value

Acknowledgement

[m][][Set ID][][OK/NG][Data][x]

35. White Balance Red Offset (Command: s x)

Adjusts the white balance red offset value.

Transmission

[s][x][][Set ID][][Data][Cr]

Data 00 to FE: Red Offset 0 to 254
FF: checks the red offset value

Acknowledgement

[x][][Set ID][][OK/NG][Data][x]

33. White Balance Green Gain (Command: j n)

Adjusts the white balance green gain value.

Transmission

[j][n][][Set ID][][Data][Cr]

Data 00 to FE: Green Gain 0 to 254
FF: checks the green gain value

Acknowledgement

[n][][Set ID][][OK/NG][Data][x]

36. White Balance Green Offset (Command: s y)

Adjusts the white balance green offset value.

Transmission

[s][y][][Set ID][][Data][Cr]

Data 00 to FE: Green Offset 0 to 254
FF: checks the green offset value

Acknowledgement

[y][][Set ID][][OK/NG][Data][x]

34. White Balance Blue Gain (Command: j o)

Adjusts the white balance blue gain value.

Transmission

[j][o][][Set ID][][Data][Cr]

Data 00 to FE: Blue Gain 0 to 254
FF: checks the blue gain value

Acknowledgement

[o][][Set ID][][OK/NG][Data][x]

37. White Balance Blue Offset (Command: s z)

Adjusts the white balance blue offset value.

Transmission

[s][z][][Set ID][][Data][Cr]

Data 00 to FE: Blue Offset 0 to 254
FF: checks the blue offset value

Acknowledgement

[z][][Set ID][][OK/NG][Data][x]

38. Backlight (Command: m g)

Adjusts the backlight brightness.

Transmission

[m][g][][Set ID][][Data][Cr]

Data 00 to 64: Backlight 0 to 100

Acknowledgement

[g][][Set ID][][OK/NG][Data][x]

39. Screen Off (Command: k d)

Turns the screen on or off.

Transmission

[k][d][][Set ID][][Data][Cr]

Data 00: turns the screen on

01: turns the screen off

Acknowledgement

[d][][Set ID][][OK/NG][Data][x]

40. Tile Mode (Command: d d)

Sets the Tile Mode and sets values for the tile rows and columns.

Transmission

[d][d][][Set ID][][Data][Cr]

Data 00 to FF: The first byte - tile column

The second byte - tile row

* 00, 01, 10, and 11 mean that the tile mode is off

Acknowledgement

[d][][Set ID][][OK/NG][Data][x]

41. Check Tile Mode (Command: d z)

Checks the tile mode.

Transmission

[d][z][][Set ID][][Data][Cr]

Data FF: checks the tile mode

Acknowledgement

[z][][Set ID][][OK/NG][Data1][Data2][Data3][x]

Data1 00: tile mode off

01: tile mode on

Data2 00 to 0F: tile column

Data3 00 to 0F: tile row

42. Tile ID (Command: d i)

Sets the tile ID value of the product.

Transmission

[d][i][][Set ID][][Data][Cr]

Data 01 to E1: Tile ID 1 to 225**

FF: checks the tile ID

** The data value cannot exceed the value of row x column.

Acknowledgement

[i][][Set ID][][OK/NG][Data][x]

* When a data value that exceeds the value of row x column is entered (except 0xFF), ACK becomes NG.

43. Natural Mode (in Tile mode) (Command: d j)

When displaying the image naturally, the part of the image that would normally be displayed in the gap between the monitors is omitted.

Transmission

[d][j][][Set ID][][Data][Cr]

Data 00: Off

01: On

Acknowledgement

[j][][Set ID][][OK/NG][Data][x]

44. DPM Select (Command: f j)

To set the DPM (Display Power Management) function.

Transmission

[f][j][][Set ID][][Data][Cr]

Data 00: Off
01: 5 seconds
02: 10 seconds
03: 15 seconds
04: 1 minutes
05: 3 minutes
06: 5 minutes
07: 10 minutes

Acknowledgement

[j][][Set ID][][OK/NG][Data][x]

47. Fail Over Select (Command: m i)

Selects an input mode for auto switch.

Transmission

[m][i][][Set ID][][Data][Cr]

Data 00: Off
01: Auto
02: Manual

Acknowledgement

[i][][Set ID][][OK/NG][Data][x]

45. Remote Control/Local Key Lock (Command: k m)

Adjusts the remote control/local key (front) lock.

Transmission

[k][m][][Set ID][][Data][Cr]

Data 00: Off (Lock Off)
01: On (Lock On)

* When the remote control and front keys are locked in Standby mode, you cannot turn on the power on by using the remote control or front power button.

Acknowledgement

[m][][Set ID][][OK/NG][Data][x]

48. Fail Over Input Select (Command: m j)

Selects an input source for auto switch.

* This command is only available when the Fail Over (auto) mode is set to Custom.

Transmission

[m][j][][Set ID][][Data1][][Data2][][Data3][][Data4][Cr]

Data 1 to 4 (Input priority: 1 to 4)
70: DVI
90: HDMI1
91: HDMI2
C0: DisplayPort

Acknowledgement

[j][][Set ID][][OK/NG][Data1][Data2][Data3][Data4][x]

Data 1 to 4 (Input priority: 1 to 4)
70: DVI
90: HDMI1
91: HDMI2
C0: DisplayPort

46. Power On Delay (Command: f h)

Sets the schedule delay when the power turns on. (unit: seconds).

Transmission

[f][h][][Set ID][][Data][Cr]

Data 00 to 64: min. 0 to maximum 100 (seconds)

Acknowledgement

[h][][Set ID][][OK/NG][Data][x]

49. IR Operation (Command: t p)

Configures the IR operation settings of the product.

Transmission

[t][p][][Set ID][][Data][Cr]

Data 00: locks off all of the keys
01: locks on all of the keys except the Power key
02: locks on all of the keys

Acknowledgement

[x][][Set ID][][OK/NG][Data][x]

50. Local Key Operation (Command: t o)

Configures the local key operation settings of the product.

Transmission

[t][o][][Set ID][][Data][Cr]

- Data 00: locks off all of the keys
 01: locks on all of the keys except the Power key
 02: locks on all of the keys

Acknowledgement

[o][][Set ID][][OK/NG][Data][x]

51. Status (Command: s v)

Checks the current signal status of the product.

Transmission

[s][v][][Set ID][][Data][][FF][Cr]

- Data 02: checks whether there is a signal or not
 10: RGB sensing OK/NG (Check Screen)

Acknowledgement

[v][][Set ID][][OK/NG][Data][Data1][x]

- Data: 02 (when a signal is found)
 Data1 00: no signal
 01: there is a signal

 Data: 10 (Check Screen)
 Data1 00: Check Screen result NG
 07: Check Screen result OK

* Treated as NG if Check Screen is set to Off

53. Speaker (Command: d v)

Sets the speaker function.

Transmission

[d][v][][Set ID][][Data][Cr]

- Data 00: Off
 01: On

Acknowledgement

[v][][Set ID][][OK/NG][Data][x]

52. Check Screen (Command: t z)

Sets Check Screen.

Transmission

[t][z][][Set ID][][Data][Cr]

- Data 00: Off
 01: On

Acknowledgement

[z][][Set ID][][OK/NG][Data][x]



NOTE

- ENERGY STAR(EPA) can not be supported in 65LS53A model.

ENERGY STAR is a set of power-saving guidelines issued by the U.S. Environmental Protection Agency(EPA).



As an ENERGY STAR Partner LGE U. S. A.,Inc. has determined that this product meets the ENERGY STAR guidelines for energy efficiency. Refer to ENERGYSTAR.gov for more information on the ENERGY STAR program.

Make sure to read the Safety Precautions before using the product.
Keep the Owner's Manual(CD) in an accessible place for future reference.
The model and serial number of the SET is located on the back and one side of the SET. Record it below should you ever need service.

MODEL _____

SERIAL _____

To obtain the source code under GPL, LGPL, MPL, and other open source licenses, that is contained in this product, please visit <http://opensource.lge.com>. In addition to the source code, all referred license terms, warranty disclaimers and copyright notices are available for download.

LG Electronics will also provide open source code to you on CD-ROM for a charge covering the cost of performing such distribution (such as the cost of media, shipping, and handling) upon email request to opensource@lge.com. This offer is valid for three (3) years from the date on which you purchased the product.

WARNING -This is a class A product. In a domestic environment this product may cause radio interference in which case the user may be required to take adequate measures.

Temporary noise is normal when powering ON or OFF this device.