



ENGLISH

OWNER'S MANUAL

REFRIGERATOR

FREEZER

Please read this manual carefully before operating your set and retain it for future reference.

P.No.: MFL67783505

www.lg.com



Table of Contents

Introduction	Registration	4
	Important Safety Instruction	4
	Identification of Parts	16
Connection	Installation	17
	Starting	17
Operation	Control panel	19
	Temperature Control	20
	Express Freeze	20
	Eco Mode	21
	Door Alarm	21
	"LOCK" (for models with LED display)	21
	Self-test	22
	Removal and installation of detachable glass shelf	22
	Removal and installation of drawers in refrigeration compartment	22
	Removal and installation of drawers in freezing compartment	23
	Storing Food	24
Care and Maintenance	General Information	25
	During Move	25
	Before switching on refrigerator operation features	25
	Anti-Condensation Pipe	25
	Cleaning	26
Trouble Shooting	Trouble Shooting	27
To Reverse the Doors	How to Reverse the Doors	28
Smart Diagnosis	Smart Diagnosis (Option)	30

Introduction

Registration

The model and serial number are found on the rear of this unit. This number is unique to this unit and not available to others. You should record requested information here and retain this guide as a permanent record of your purchase. Staple your receipt here.

Date of Purchase : _____

Dealer Purchased From : _____

Dealer Address : _____

Dealer Phone No. : _____

Model No. : _____

Serial No. : _____

Important Safety Instruction

BASIC SAFETY PRECAUTIONS

This guide contains many important safety messages. Always read and obey all safety messages.

 This is the safety alert symbol. It alerts you to safety messages that inform you of hazards that can kill or hurt you or others or cause damage to the product. All safety messages will be preceded by the safety alert symbol and the hazard signal word DANGER, WARNING, or CAUTION. These words mean:

 **DANGER** Important safety instructions must be followed carefully. If not, this can result in serious injury or death.

 **WARNING** Important safety instructions must be followed carefully. If not, this can result in serious injury or death.

 **CAUTION** Indicates an imminent hazard, which if not avoided can result in personal injury or damage to the product.

Before it is used, this refrigerator must be properly installed and located in accordance with the installation instructions in this document.

All safety messages will identify the hazard, tell you how to reduce the chance of injury, and tell you what can happen if the instructions are not followed.

Important Safety Instruction

⚠ WARNING

To reduce the risk of fire, electric shock, or injury to persons when using your product, basic safety precautions should be followed, including the following. Read all instructions before using this appliance.

1. When connecting the power

A dedicated outlet should be used.

- Using several devices at one outlet may cause fire.
- If ELCB (Earth leakage circuit breaker) is tripped, food inside fridge will spoil.



Do not allow the power plug to face upward or to be squeezed at the back of the fridge-freezer.

Water may flow into the socket and cause fire and electric shock.

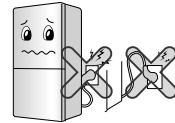

Do not allow the power cord to be bent or crushed by the refrigerator or any other heavy object.

This can damage the power cord and cause fire and electric shock.



Do not extend or modify the length of the power plug.

This can cause electric shock or fire due to non electrical compliance.



Unplug the power plug when cleaning, handling or replacing the interior lamp of the fridge-freezer.

- Failing to do this may cause electric shock or injury.
- When replacing the interior lamp of the fridge-freezer, make sure that any rubber is not removed from the socket, and that the socket is not altered in any way.



Should this appliance be fitted with LED internal lighting, please call the manufacturer for service in the event of a problem with the LED lighting.

Important Safety Instruction

Do not pull out the cord or touch the power plug with wet hands.

- It may cause electric shock or injury.



Remove water or dust from the power plug and insert it with the ends of the pins securely connected.

Dust, water or an unsecure connection to the power outlet may cause fire or electric shock.

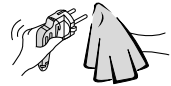

Ensure that a proper earthed power outlet is used.

A poorly earthed connection or power outlet may cause malfunction and electric shock.

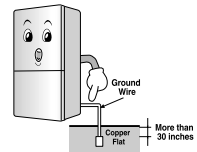

Do not operate the refrigerator if the plug or lead is damaged, or the plug is loose in the power outlet.

This may cause electric shock or a short circuit and may cause fire.

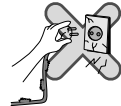

2. When using the fridge-freezer

Do not place any heavy or dangerous objects (including contained fluids, vases or cups) on top of the refrigerator.

Objects can fall or spill and cause injury, fire or electric shock if they come into contact with the power cord.



Do not allow any persons to climb, swing or rest on the doors, or door shelves, or any other part of the refrigerator.

It can cause the unit to fall or tip over and cause serious injury.



Important Safety Instruction

Do not install the fridge-freezer in an outdoor sheltered area or where it can be exposed to humidity or wet weathering or direct sunlight.

Water penetration and deterioration to insulation of electric parts may cause electric shock or fire.



Do not store inflammable materials such as solvents, ether, benzene, alcohol, medicine, LP Gas, aerosol cans, and cosmetics near or in the refrigerator.

They can cause an explosion or fire.

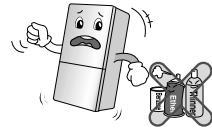

Do not place a lit candle with in the fridge-freezer to deodorize. Do not use a drier to dry the inside, nor light a candle to remove odor.

It may cause explosion or fire.

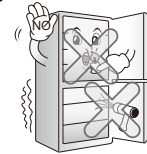

Do not store any medicine in the refrigerator UNLESS specified by the medicine instructions. Do not store scientific materials, chemicals or solutions inside the refrigerator. This refrigerator is intended for domestic food storage applications. It should not be used for mobile applications or commercial purposes.

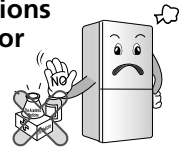

If gas is leaked, do not touch the fridge-freezer or the outlet and ventilate the room immediately.

Static or sparks could trigger an explosion of fire and cause burns. Because this fridge-freezer uses natural gas (isobutene, R600a) as the environment-friendly refrigerant, even a small amount (80~90g) is combustible. If there is a gas leak as a result of severe damage during delivering, installing or using the fridge-freezer, any spark may cause fire or burn.

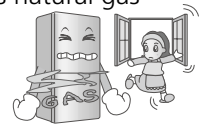

Do not use any combustible sprays near the fridge-freezer. Do not store explosive substances such as aerosol cans with a flammable propellant in this appliance.

It may cause fire.



Important Safety Instruction

Avoid placing the refrigerator near any heating devices or sources.

It may cause fire.

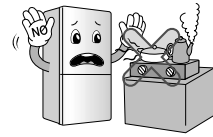

If fridge has been submerged in water , do not plug in or turn it on. This may cause electric shock or fire.

It should be checked by a qualified person before plugging it in.

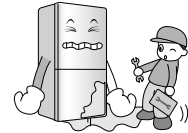

Do not spray water on the inside or outside fridge surface, and DO NOT clean the refrigerator with benzene, thinners or other hazardous chemicals.

Doing so can cause corrosion, odour contamination, fire and electric shock.



Unplug the power plug when cleaning, handling or replacing the interior lamp (were fitted) of the fridge-freezer.

It may cause electric shock or injury.

When replacing the interior lamp of the fridge-freezer, make sure that the rubber ring for preventing a spark

within the socket is not taken off. If the

unit has LED internal lighting, call the manufacturer for service in the even that it has malfunctioned. do not attempt to remove the LED lighting module..

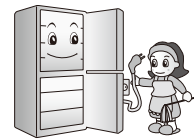

In case of a severe electrical storm, remove the power cord from the power outlet until the storm eases and avoid opening the doors during that time.



There is a danger of electric shock or fire.

Do not place flower vase, cup, cosmetics, medicine or any container with water on the fridge-freezer.

It may cause fire, electric shock or injury if they spill.



Upon opening or closing of the door, unstable objects may spill or, fall, and result in injury.

It may cause fire, electric shock or injury.



Important Safety Instruction

If any strange smell or smoke is detected from the fridge-freezer, disconnect the power plug immediately and contact an LG Authorised Service Centre.

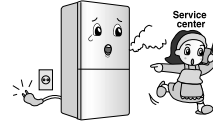

Do not allow any person except qualified technicians to repair, disassemble, or alter the refrigerator.

Not doing so could cause a malfunction, fire and possible electric shock.

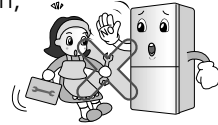

Do not use the fridge-freezer for non-domestic purposes (storage of medicines or testing materials etc.). It must be used for domestic food storage applications only. Doing so may cause a fire, electric shock and other unexpected hazards.

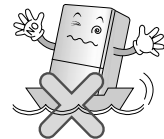

When disposing the fridge-freezer, remove the doors and power cord to prevent potential serious injury and safety hazards to children and others.



Install the fridge-freezer on a solid and level floor.

Installing it in an unstable place may cause it to fall resulting in serious injury and damage to the refrigerator. The refrigerator's stability can be checked by opening and closing the door.

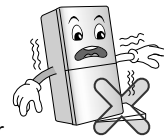

Important Safety Instruction

Do not put hands or other objects into the rear service panel for any reason.

Doing so can cause serious injury, malfunction, fire and electric shock.



When you want to dispose the fridge-freezer, contact your local council. They may be able to assist you with the disposal.



Avoid contact of fats and oils (including vegetable) onto plastic parts of the refrigerator.

This causes the plastic to discolour and weaken.



⚠ CAUTION

Violating this direction may cause injury or damage to house and furniture. Always be careful, please.

Do not touch food or containers in the freezer with wet hands.

It may cause frostbite.

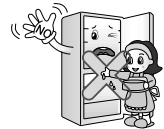

If the refrigerator requires disconnection from the mains for any reason, please wait 5 minutes before reconnecting to avoid any direct malfunction.

After reconnecting, the compressor will then operate after a further 3 minutes.



Do not put bottles or cans in the freezer.

The contents may freeze causing them to shatter or split.



Do not remove the power plug from the power outlet by pulling it from the cord. It could cause damage to the cord, electrical short circuit, and electric shock.



The power outlet should be easily accessible in the event of necessary quick disconnection.

When one door of the refrigerator is closed abruptly, another door may open, this is normal as the refrigerator compartments are connected by air ducts.

Important Safety Instruction

Do not install the fridge-freezer in a wet place or a place which water or rain splashes such as an outdoor sheltered area.

Deterioration of the insulation of electric parts may cause electric leakage or electric shock.



Do not insert the hands into the bottom of the fridge-freezer.

The iron plate of the bottom may cause injury.



Carry the fridge-freezer with the handle bar at the bottom of the front and the top of the rear.

Otherwise, your hands could slip and be injured.

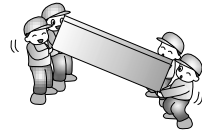

Because opening or closing the door of the fridge-freezer may cause injury to the person around it, be careful, please.

Opening or closing the door may cause feet or hands to be caught in the door hinges, or child to be hurt by the door edge.

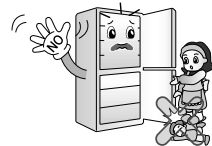

Do not put any living animal in the fridge-freezer.

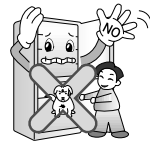

⚠ CAUTION

This appliance can be used by children aged from 8 years and above and persons with reduced physical, sensory or mental capabilities or lack of experience and knowledge if they have been given supervision or instruction concerning use of the appliance in a safe way and understand the hazards involved.

Children shall not play with the appliance.

Cleaning and user maintenance shall not be made by children without supervision.

Important Safety Instruction

⚠ WARNING

Precaution

- This fridge-freezer must be properly installed and located in accordance with the Installation Instruction before it is used.
- Never unplug your fridge-freezer by pulling on the power cord. Always grip plug firmly and pull straight out from the outlet.
- When moving your appliance away from the wall, be careful not to roll over or damage the power cord.
- After your fridge-freezer is in operation, do not touch the cold surfaces in the freezer compartment, particularly when hands are damp or wet. Skin may adhere to these extremely cold surfaces.
- Pull out the power plug prior to cleaning the fridge-freezer.
Never damage, severely bend, pull out, or twist the power cord because power cord damage may cause a fire or electric shock.
Never place glass products in the freezer because they may be broken when their inner contents are frozen.
- Do not directly spray water inside or outside the fridge/freezer.
This can cause an electrical hazard, electric shock or fire.
- Do not insert the power plug with wet hands.
You may receive an electric shock.
- Do not put a container filled with water on top of the appliance.
If the water spills on to any electrical parts, it may lead to fire or electric shock.
- Do not install the fridge/freezer in a damp place, where it could be splashed with water.
Wet insulation, or electrical parts may cause an electric shock or fire.

Important Safety Instruction

- Do not disassemble, repair or alter the appliance. It may cause fire or abnormal operations, which may lead to injury.
- Pull the power plug out of the socket before replacing the interior lamp (if fitted) in the refrigerator. If the refrigerator has LED lighting, call the manufacturer for service in the event that it malfunctions. do not remove the LED module.

Otherwise, there is a risk of electric shock.

It may cause electric shock or fire.

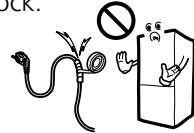

Do not modify or extend the Power Cord length

Don't Use on Extension Cord

Accessibility of Supply Plug

Supply Cord Replacement

⚠ DANGER

Don't store

Grounding (Earthing)

If possible, connect the fridge-freezer to its own individual electrical outlet to prevent it and other appliances or household lights from causing an overload.

The supply plug of the refrigerator-freezer should be placed in easy accessible position for quick disconnection in emergency.

If the supply cord is damaged, it must be replaced by the manufacturer or its service agent or a similarly qualified person in order to avoid a hazard.

Risk of child entrapment.

Before you throw away your old refrigerator or freezer: Take off the doors.

Leave the shelves in place so that children may not easily climb inside.

Don't store or use gasoline or other flammable vapors and liquids in the vicinity of this or any other appliance. In the event of an electric short circuit, grounding (earthing) reduces the risk of electric shock by providing an escape wire for the electric current. In order to prevent possible electric shock, this appliance must be grounded. Improper use of the grounding plug can result in an electric shock. Consult a qualified electrician or service person if the grounding instructions are not completely understood, or if you have doubts on whether the appliance is properly grounded.

⚠ CAUTION

Important Safety Instruction

- If the wall socket is loose, do not insert the power plug.
It may cause electric shock or fire.
- Never unplug your refrigerator by pulling on the power cord. Always grip plug firmly and pull it straight out from the outlet.
You may disconnect a wire and cause a short circuit.
- Do not use a wet or damp cloth when cleaning the plug. Remove any foreign matter from the power plug pins.
Otherwise, there is a risk of fire.
- Do not put your hands into the bottom area of the appliance.
Any Sharp edges may cause personal injury..
- After unplugging the appliance, wait for at least five minutes before plugging it again to the wall socket.
Abnormal operation of the freezer may cause material damage.
- If the appliance is not to be used for a long time, pull out the power plug.
Any deterioration in the insulation may cause fire.
- Do not let children touch or play with the control panel on the front of the appliance.
- The refrigerant used in fridge/freezer and the gases in the insulation material require special disposal procedures. Ensure that none of the pipes on the back of the appliances are damaged prior to disposal.

Important Safety Instruction

⚠ WARNING

- ⚠ Keep ventilation openings, in the appliance enclosure or in the built-in structure, clear of obstruction.
- ⚠ Do not use mechanical devices or other means to accelerate the defrosting process, other than those recommended by the manufacturer.
- ⚠ Do not damage the refrigerant circuit.
- ⚠ Do not use electrical appliances inside the food storage compartments of the appliance, unless they are of the type recommended by the manufacturer.
- ⚠ The refrigerant and insulation blowing gas used in the appliance require special disposal procedures. When disposal, please consult with service agent or a similarly qualified person.



This appliance contains a small amount of isobutane refrigerant (R600a), natural gas with high environmental compatibility, but it is also combustible. When transporting and installing the appliance, care should be taken to ensure that no parts of the refrigerating circuit are damaged. Refrigerant squirting out of the pipes could ignite or cause an eye injury. If a leak is detected, avoid any naked flames or potential sources of ignition and air the room in which the appliance is standing for several minutes.

In order to avoid the creation of a flammable gas air mixture if a leak in the refrigerating circuit occurs, the size of the room in which the appliance may be sited depends on the amount of refrigerant used. The room must be 1m² in size for every 8g of R600a refrigerant inside the appliance. The amount of refrigerant in your particular appliance is shown on the identification plate inside the appliance.

Never start up an appliance showing any signs of damage. If in doubt, consult your dealer.

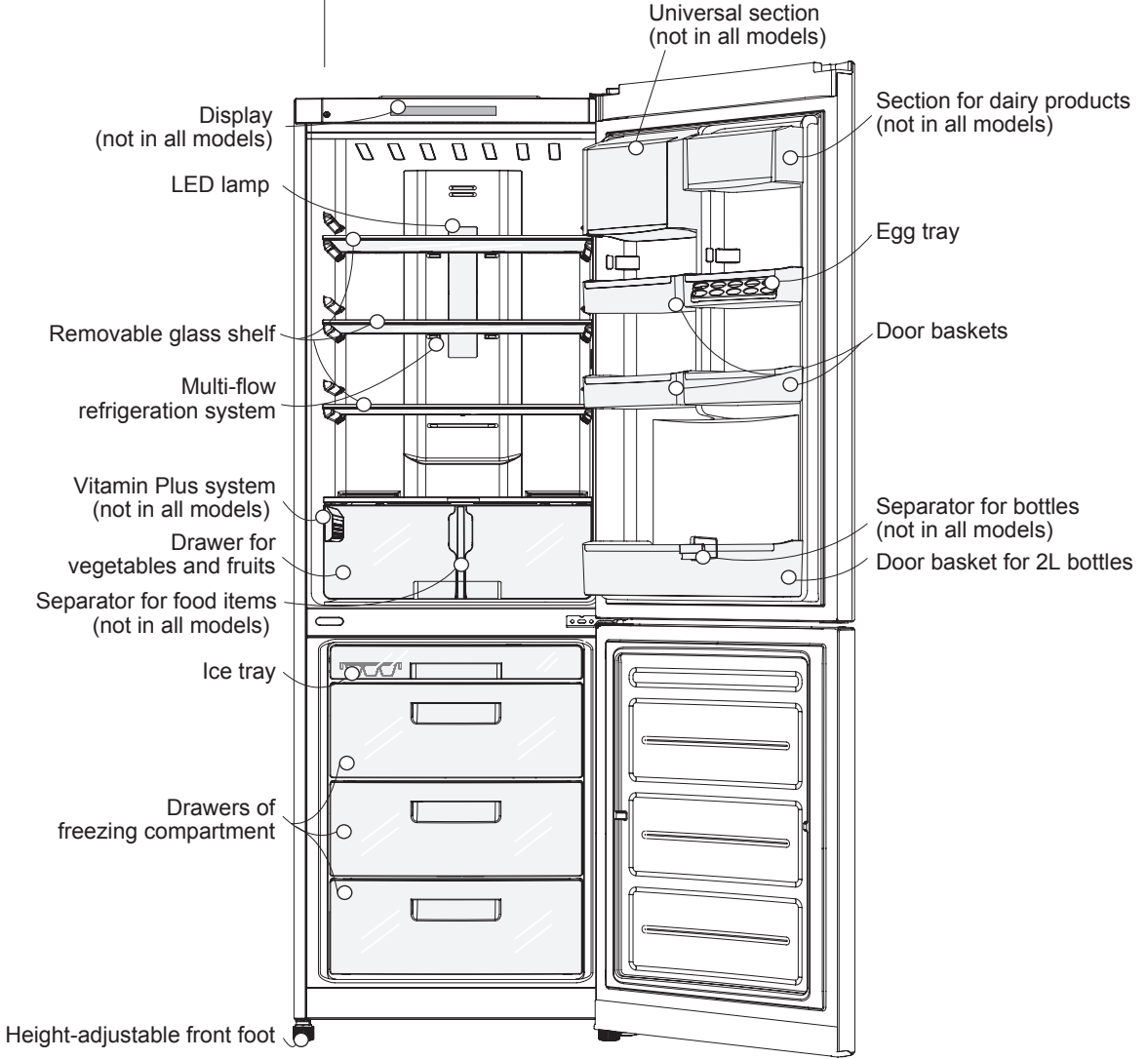

Identification of Parts



Note

If you find some parts or accessories missing from your unit, they may be parts only used in other models.

Installation

- Install the limit stops to the upper corners on the rear wall of the refrigerator as shown in Fig.1. The stops are supplied in the door basket inside the refrigeration compartment;
- Choose a suitable place. Locate the refrigerator in a place convenient for its use;
- The refrigerator is not a built-in appliance. Free space not less than 5 cm should be provided from above, from its rear and side faces for air circulation and reduction of power consumption. Fig.2;
- Do not install the refrigerator near heat sources and in a zone exposed to direct sunlight or high humidity;
- Make sure that electrical voltage indicated in the manual meets the parameters of your mains voltage. It should only be connected to a town mains supply.
- Do not remove the round stickers on the rear side of the refrigerator. They have a decorative function closing the fabrication holes;
- To exclude vibration, check the refrigerator installation using a level. If necessary, turn the adjustable front feet to compensate irregularity of the floor.
To raise the front part of the refrigerator, turn the adjustable front feet counter-clockwise () to lower it – turn them clockwise ();
- This appliance is intended to be used in household and similar applications such as staff kitchen areas, offices and other working environments; and by clients in hotels, motels and other residential type environments; bed and breakfast type environments; it is not intended for mobile or commercial applications.
- Do not store explosive substances such as aerosol cans with a flammable propellant in this appliance.
- To ensure proper air circulation around the fridge-freezer, please maintain sufficient space on both the sides as well as top and maintain at least 2 inches (5cm) from the rear wall.
- Before use, carefully wash the refrigerator;
- Install the removable parts, such as ice tray, etc. to the appropriate places as it is necessary to prevent possible damages during transportation;
- Insert the power cord plug to the power outlet. Do not power other electric appliances from the same outlet.

Starting

When your fridge-freezer is installed, allow it 3-4 hours to stabilize at normal operating temperature prior to filling it with fresh or frozen foods.

If power plug is disconnected, allow 5 minutes delay before restarting.

Your fridge-freezer is now ready for use.

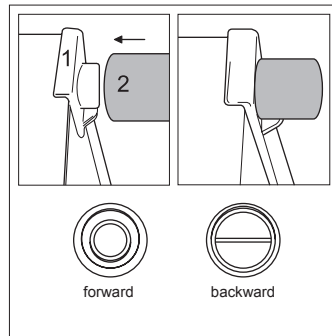

Figure 1. Installation of limit stops

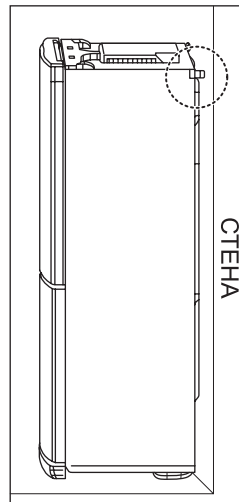

Figure 2. Installation of refrigerator to wall

NOTE

The limit stops are located in the door basket of the refrigeration compartment. They should be installed to get higher operational efficiency of the refrigerator.

CONTROL PANEL

External light-emitting-diode (LED) display

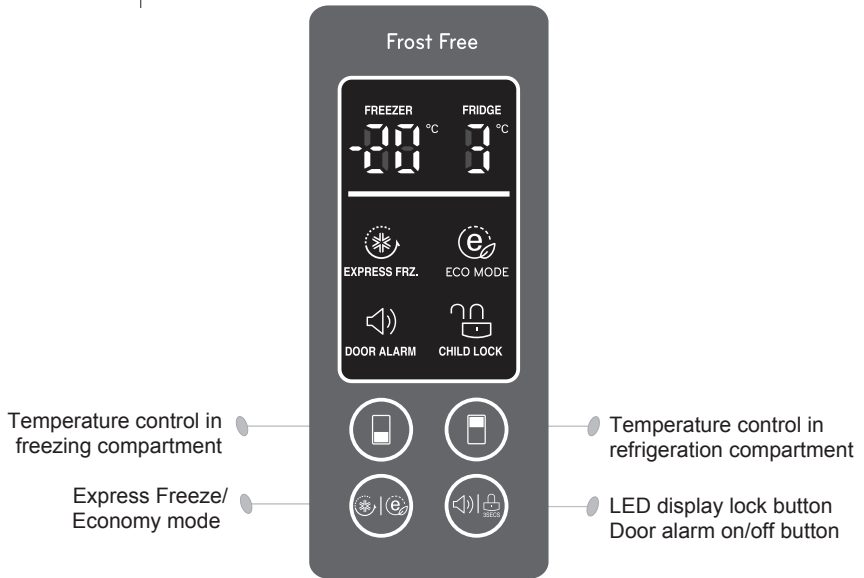

Internal display

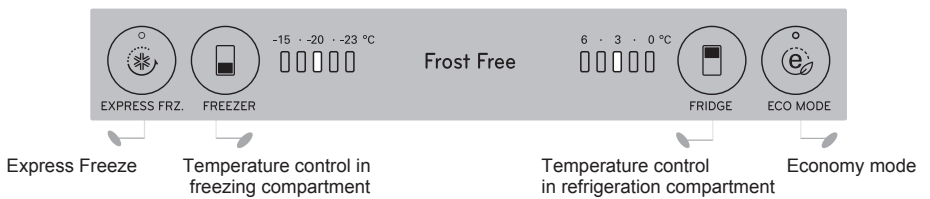

TEMPERATURE CONTROL

The initial temperature in the refrigeration and freezing compartments is 3 °C and -20 °C, respectively. If you wish, you can change it by pushing the temperature control button of the appropriate compartment.

External LED display

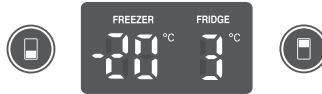

Internal LED display

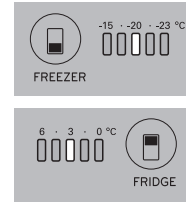

NOTE

Temperature indicated on the LED display is a target value, since actual temperature inside the refrigerator varies depending on intensity of exposure to external factors, such as temperature of placed food items and door opening frequency. The refrigerator may take up to 3 days to settle into a cooling pattern after initially installed. Please readjust the temperature as above if necessary after using the refrigerator for 2 ~ 3 days.

EXPRESS FREEZE

This function is used when you want to freeze the foods quickly. Press the 'EXPRESS FREEZE' button once, and then the Express freezer operation will start and the indicator will be on. The Express Freeze operation takes about 24 hours. When its operation ends, it automatically returns to the previous temperature setting. If you want to end the Express freeze operation manually at any time, press the 'EXPRESS FREEZE' button once more, and the indicator will go out, and the Express freeze operation stops and the refrigerator will return to the previous temperature setting.

External LED display

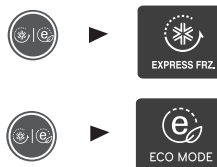

Internal LED display



ECO MODE

Economy Mode minimises power consumption by setting the Fridge and Freezer temperatures to the target temperatures used in the Australian/ New Zealand refrigerator performance standard AS/NZS 4474.1.

Turning down the temperatures to a cooler setting uses more electricity and increases the running cost.

Push the "EXPRESS FREEZE /Economy mode" button twice (on the external display) or the "Economy mode" button once (on the internal display) to activate Economy mode.

The indicator ECO MODE will light, repeated pushing of the button will deactivate the Economy mode.

External LED display



Internal LED display



NOTE

In Economy mode the external display is switched to energy conservation mode – only the "LOCK" indicator will light when activated.

When the "Economy mode" is activated the temperature setting buttons are deactivated.

DOOR ALARM

- If the refrigerator door is opened for some time (30 sec), the door alarm will sound.
- You can enable and disable the door alarm by pushing the "ALARM" button (not on all models);
- If the alarm continues to sound even after closure of the door, contact the service center.

External LED display



"LOCK" (for models with LED display)

- When the "LOCK" button is activated, other buttons are inoperative;
- To lock/unlock the refrigerator display, push the "LOCK" button and hold it for 3 seconds.



NOTE

In the event of power cut off, the mode settings are kept.

SELF-TEST

The display has a self-test function.

If the refrigerator has a failure, the buttons become inoperative and the indicator shows the error code. In this case, do not switch off the power and immediately contact an authorised Service provider.

If you switch off the refrigerator, the error will reset and also be difficult for the technician to diagnose.

REMOVAL AND INSTALLATION OF DETACHABLE GLASS SHELF

To remove a shelf from the refrigerator, first slightly raise it (1) and then pull (2). Improper removal may result in damage of internal parts in the refrigerator.

To install a shelf to the refrigerator, proceed in the same way: first raise the front edge of the shelf (3) and then locate it into the refrigerator (4). Improper installation may result in damage of internal parts in the refrigerator.

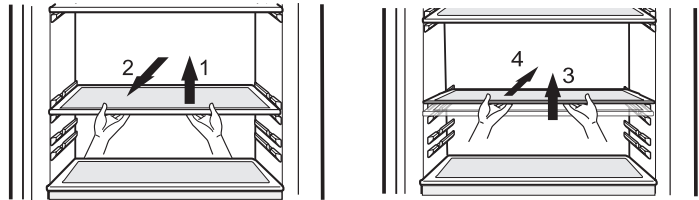

REMOVAL AND INSTALLATION OF DRAWERS IN REFRIGERATION COMPARTMENT

To remove the lower drawer from the refrigeration compartment, proceed as follows:

- Remove the lower basket from the door by gently raising the basket;
- Pull the drawer out as far as it will go, then raise the front and continue to pull out.
- Raise the drawer cover by the front part and pull to remove it;
- To install the drawer back, proceed in the reverse sequence.



⚠ CAUTION!

Improper removal and installation may result in damage of internal parts in the refrigerator.

REMOVAL AND INSTALLATION OF DRAWERS IN FREEZING COMPARTMENT

Always empty the drawers before removing them.

To remove any drawer of the freezing compartment, proceed as follows:

1. Pull the drawer all the way out as far as it will go.
2. Raise it at the front and continue to pull it out.

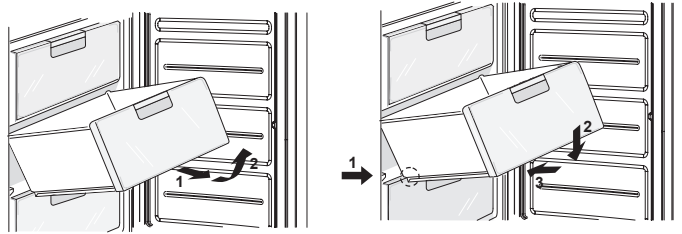

To install any drawer back into the freezing compartment, proceed in the reverse sequence:

1. Place the drawer onto the guides at an angle 45°;
2. Lower the front part of the drawer in parallel to the guides as you push it in.
3. Push the drawer all the way in.

Do not apply excessive force to remove the drawers and shelves – this may result in damage of the refrigerator.

NOTE

The warranty does not cover mechanical damages (cracks, shears, dents, scratches, chips, etc.) caused by violation of the refrigerator storage, transportation, operation, and maintenance instructions, and by application of excessive force.

⚠ CAUTION!

Do not apply excessive force to remove the drawers and shelves – this may result in damage of the refrigerator.

ICE PREPARATION

Fill the ice tray with water and place it to the freezing compartment.



If ice cubes are required as soon as possible, activate the "EXPRESS FREEZE" function.

To remove ice cubes, hold the tray on ends and slightly bend it.

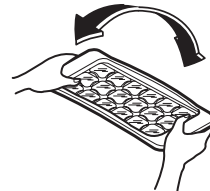

ADVICE

To easily remove cubes, water the tray in advance.

⚠ WARNING

Fill with potable water only.

Storing Food**Storing Food**

- Do not store food which goes bad easily at low temperature, such as banana, and melon.
- Allow hot food to cool prior to storing. Placing hot food in the fridge-freezer could spoil other food, and lead to higher electric bills.
- When storing the food, use a container with a lid. This prevents moisture from evaporating, and helps food to keep its taste and nutrients.
- Do not block air vents with food. Smooth circulation of cold air keeps fridge-freezer temperature even.
- Do not open the door frequently. Opening the door lets warm air enter the fridge-freezer, and cause temperature to rise.
- To adjust the temperature control easily, do not store food near the temperature control dial.
- Never keep too many foods in door rack, as this may stop the door from fully closing.
- Do not store bottles or cans in the freezer compartment - they may break when frozen.
- Do not refreeze food that has been thawed. This causes loss of taste and nutrition.
- If it is necessary to quickly freeze fresh food items, place them to the lower drawer of the freezing compartment and push the "EXPRESS FREEZE" button;
- Frozen food items should be stored packed (in polyethylene film, aluminum foil, etc.) in the freezing compartment;

Note

If you keep the fridge-freezer in a hot, and humid place, frequently open its door or put a lot of vegetables in it, dew or frost may form in it, which has no effect on its performance. Remove the dew and frost a dust free cloth.

VITAMIN PLUS (OPTIONAL)

It contains anti-oxydant that is able to avoid oxidation process in order to make the fruits and vegetables fresh for longer time.

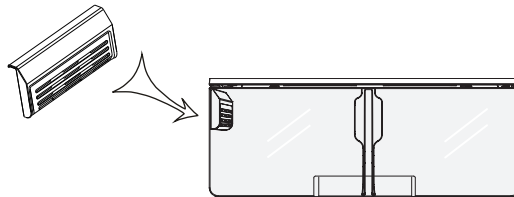

This part contains anti-oxydant substance that should not be eaten. Opening and closing the door too much often can reduce its lifetime.

General Information

Power Failure

- 1~2 hour power failure does no harm to the stored foods.
Try to avoid opening and closing the door too frequently.

DURING MOVE

- Remove all food items and other objects from the refrigerator
Firmly secure the internal detachable parts (shelves, drawers, door baskets);
- To avoid damage of the floor and adjustable front feet of the refrigerator, turn them counter-clockwise before transportation;
- The refrigerator should be firmly secured to prevent it from dislodging or moving during transportation.
- The refrigerator should be transported in a vertical position in a suitable vehicle.
The original package should not be damaged during the initial transportation;
- During loading and unloading, the refrigerator should be protected against impacts.
- If the refrigerator is transported during a cold season, unpack the refrigerator in a warm room and do not switch on it for at least 12 hours.

BEFORE SWITCHING ON

⚠ CAUTION!

Do not move or incline the refrigerator during its operation.
Noise may occur in the compressor.

This feature does not affect operability of compressor. If the noise does not stop within 10 seconds, then turn off the refrigerator, wait for 1 minute then turn back on again.

REFRIGERATOR OPERATION FEATURES

Cracking noise may be heard due to thermal changes of the refrigerator components.

Typical sounds from activation of the thermostatic controller and compressor are normal sounds occurring during operation of electric equipment in the appliance.

The refrigerant circulating inside the refrigeration system may calmly gurgle, even if the compressor is not in operation.

Do not worry, this is absolutely normal.

The following sounds may be heard during operation of the refrigerator:

- Clicks from actuation of the temperature sensor/switch;
- Murmur of the refrigerant circulating in tubes of the refrigeration system;
- Slight cracking noise from thermal changes of internal parts.

These sounds are not associated with any defect and they have a functional aspect.

Anti Condensation Pipe

- The Anti-Condensation pipe is installed around the front side of fridge-freezer as well as on the partition between fridge compartment and freezer compartment to prevent dew, or sweating.
- Especially after installation or when ambient temperature is high, the fridge-freezer may feel hot, which is quite normal.

Anti-Condensation Pipe

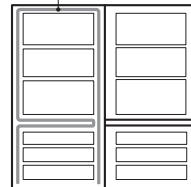

Cleaning

Before Cleaning

Be sure to unplug the power.

Exterior

Clean the outside of the fridge-freezer with a soft cloth soaked with hot water or liquid dishwashing detergent. If you use a detergent, be sure to wipe it with a clean wet cloth.

For products with a stainless steel exterior, use a clean sponge or soft cloth and a mild dish washing detergent in warm water. Do not use abrasive or harsh cleaners.

Dry thoroughly with a Soft cloth.

Do not use appliance wax, bleach, or other products containing chlorine on stainless steel.

Interior

As above.

After Cleaning

Check that the power cord is not damaged, power plug has not overheated, and that the power plug is firmly inserted into the outlet.

CAUTION!

Be sure to dry the appliance with a cloth after washing it with water.

Do not use abrasive, petroleum, benzene, thinner, hydrochloride acid, boiling water, harsh brushes, etc, as they may damage parts of the fridge-freezer.

Trouble Shooting

Before calling for service, check this list. It may save you both time and expense.

This list includes common occurrences that are not the result of defective workmanship or materials in this appliance.

Problem	Possible Causes
Fridge-Freezer does not operate	<ul style="list-style-type: none"> • Power plug may be unplugged from the electric outlet. Plug it in securely. • House fuse has blown or circuit breaker has tripped. Check and/or replace fuse and reset circuit breaker. • Power cut. Check other power outlets.
Fridge or Freezer Compartment Temperature too warm	<ul style="list-style-type: none"> • Temperature control not set on proper position. Refer to Temperature Control section. • Appliance is placed close to heat source. • Warm weather-frequent door openings. • Door left open for a long time. • Package holding door open or blocking air duct in freezer compartment.
Vibration or Rattling or Abnormal Noise	<ul style="list-style-type: none"> • The floor on which the fridge-freezer is installed may be uneven or the fridge-freezer may be unstable. Make it even by rotating front leveling feet. • Unnecessary objects placed in the back side of the fridge-freezer.
Frost or Ice Crystals on frozen Food	<ul style="list-style-type: none"> • Door may have been left ajar or package holding door open. • Too frequent or too long door openings. • Frost within package is normal.
Moisture forms on Cabinet Surface Moisture collects inside	<ul style="list-style-type: none"> • This phenomenon is likely to occur in a wet space. Wipe it with a dry towel. • Too frequent or too long door openings.
Fridge has odor	<ul style="list-style-type: none"> • In humid weather, air carries moisture into fridge when doors are opened. • Foods with strong odors should be tightly covered or wrapped. • Check for spoiled food. • Interior needs cleaning. Refer to CLEANING section
Door not closing properly	<ul style="list-style-type: none"> • Food package is keeping door open. Move packages that keep door from closing. • Fridge-freezer is not level. Adjust the front leveling feet.
Interior light does not work	<ul style="list-style-type: none"> • The floor on which the fridge-freezer is installed may be uneven or the fridge-freezer may be unstable. Slightly raise the front side with the front leveling feet. • No power at outlet. • Light lamp needs replacing or faulty LED module. Refer to the Lamp Replacement section. if fitted with LED lighting, call the manufacturer for a service technician. DO NOT ATTEMPT TO REMOVE THE LED MODULE.

TO REVERSE THE DOORS

How to Reverse the Doors

The refrigerator is designed so that the doors can be opened right or left depending on the layout of your kitchen.

⚠ CAUTION!

1. Prior to hinging the door to the opposite side, first of all unload the refrigerator from foodstuffs and remove all unsecured accessories (shelves and drawers) from it.
2. To tighten and loose bolts, use a socket wrench or a box wrench for 10 mm.
3. Do not lay the refrigerator onto the floor.
4. Take care to exclude dropping of the door in the process of disassembly or assembly.

1. Unscrew the screw **2** of the upper hinge cover **1** to remove the hinge cover **1** and disconnect the connection cable **5** (only for models with an external display). Unscrew the bolts **3** fixing the upper hinge **4** and carefully remove the door from the middle hinge **16**. Remove the blank **8**.

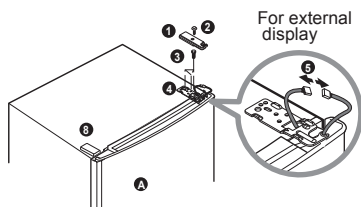

2. Remove the upper door cover **7** (only for models with an external display), pull out the cable **5** and install it to the hole on the opposite side of the door. Install the upper door cover **7** into place.

Remove the plastic bushing **6** from the door of the refrigeration compartment **A**. Unscrew the screw **10** located above the door of the refrigerator and move the door stop **9** to the opposite side. Tighten the screw **10**. Move the plastic bushings **6** and **14** (only for models with an internal display) to the opposite side.

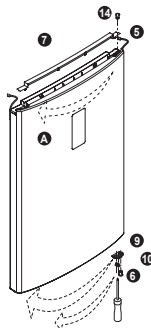

3. (Only for models with an external display). Using a flat screwdriver, push and separate the caps **12** from the front panel **11** and unscrew the screws **13**, remove the panel **11**, move the cable **15** to the opposite side. After installation of the panel **11** into place, tighten the screws **13** and close their heads with the caps **12**.

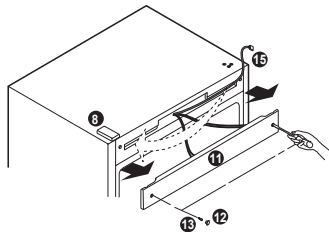

4. Unscrew the bolts **17** of the middle hinge, remove the middle hinge and raise the door of the freezing compartment **5** to remove the door. Remove the blank **18** and install it instead of the removed middle hinge **18**.

Unscrew the dowel 22 of the lower hinge 23 turning it counter-clockwise and screw the dowel into the opposite hole. Unscrew the bolts 24 fixing the lower hinge 23 and bolt 25 on the refrigerator enclosure. Unscrew the screw 10 on the lower part of the door fixing the door closer 29 of the freezing compartment B. Unscrew the screw 10 on the lower part of the door fixing the door stop 9 of the freezing compartment B, move the stop 9 to the opposite side into the dedicated place and fix it. Rehinge the closer 29 to the opposite side into the dedicated place and fix it. Move the upper cap 26 to the opposite side.

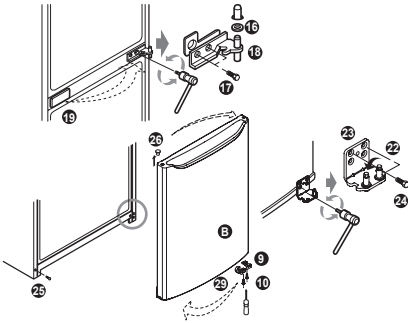

5. Attach the removed lower hinge 23 to the holes located on the opposite side of the enclosure and fix the hinge with the bolts 24. Tighten the screw 25 in the enclosure on the opposite side. Install the door of the freezing compartment B onto the lower hinge dowel 23. Unfold the removed middle hinge 18 with its axis out and fix the hinge with the bolts 17 (tighten the bolts carefully to exclude scratching of the door). Install the washer 16 onto the middle hinge 18.

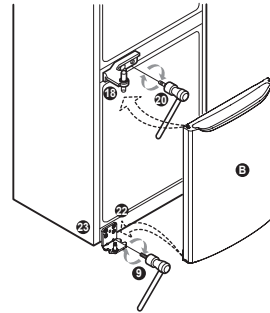

6. Install the door of the refrigeration compartment A aligning the hole in the lower part of the door and middle hinge dowel 18. Then install the upper hinge 27 supplied in the refrigerator package placing the dowel into the appropriate upper hole in the door of the refrigeration compartment A. Connect the cable connectors 5 (only for models with an external display). Fix the upper hinge 27 using the bolts 3. Install the left cover of the upper hinge 25 and fix it with the screw 2. Install the blank 28 supplied in the refrigerator package.

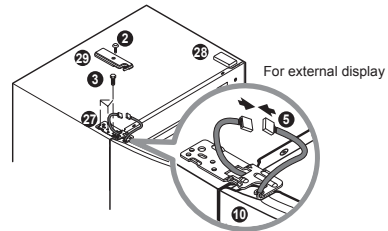

NOTE

Reversing the doors is not covered by the warranty.

SMART DIAGNOSIS

Should you experience any problems with your refrigerator, it has the capability of transmitting data via your telephone to the LG service center. This gives you the capability of speaking directly to our trained specialists. The specialist records the data transmitted from your machine and uses it to analyze the issue, providing a fast and effective diagnosis.

If you experience problems with your refrigerator, call the phone No. of LG Customer Information Center. Only use the Smart Diagnosis feature when instructed to do so by the LG call center agent. The transmission sounds that you will hear are normal and sound similar to a fax machine.

Smart Diagnosis cannot be activated unless your refrigerator is connected to power. If your refrigerator is unable to turn on, then troubleshooting must be done without using Smart Diagnosis.

Using Smart Diagnosis

First, call the phone No. of LG Customer Information Center. Only use the Smart Diagnosis feature when instructed to do so by the LG call center agent.

- 1 Lock the display. (Option)
To lock the display, press and hold the Lock button for three seconds. (If the display has been locked for over five minutes, you must deactivate the lock and then reactivate it.)



- 2 Open the refrigerator door.

- 3 Hold the mouthpiece of your phone in front of the speaker that is located on the right hinge of the refrigerator door, when instructed to do so by the call center.

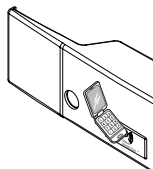

- 4 Press and hold the Freezer Temperature button for three seconds while continuing to hold your phone to the speaker.



- 5 After you hear three beeps, release the Freezer Temperature button.
- 6 Keep the phone in place until the tone transmission has finished. This takes about 15 seconds, and the display will count down the time. Once the countdown is over and the tones have stopped, resume your conversation with the specialist, who will then be able to assist you in using the information transmitted for analysis.

NOTE

- For best results, do not move the phone while the tones are being transmitted.
- If the call center agent is not able to get an accurate recording of the data, you may be asked to try again.

NOTE

- Call quality differences by region may affect the function.
- Use the home telephone for better communication performance, resulting in better service.
- Bad call quality may result in poor data transmission from your phone to the call center, which could cause Smart Diagnosis to not work properly.