



ENGLISH

OWNER'S MANUAL

DVD Home Cinema System

Please read this manual carefully before operating your set and retain it for future reference.

FOR THE GUARANTEE TERMS & CONDITIONS, PLEASE REFER TO LAST SECTION ON THE OTHER SIDE OF THE BACK COVER.

DH3140S (DH3140S, S34S1-S, S34S1-W)



MFL09153686

www.lg.com

Safety Information



CAUTION: TO REDUCE THE RISK OF ELECTRIC SHOCK DO NOT REMOVE COVER (OR BACK) NO USER-SERVICEABLE PARTS INSIDE REFER SERVICING TO QUALIFIED SERVICE PERSONNEL.



This lightning flash with arrowhead symbol within an equilateral triangle is intended to alert the user to the presence of uninsulated dangerous voltage within the product's enclosure that may be of sufficient magnitude to constitute a risk of electric shock to persons.



The exclamation point within an equilateral triangle is intended to alert the user to the presence of important operating and maintenance (servicing) instructions in the literature accompanying the product.

WARNING: TO PREVENT FIRE OR ELECTRIC SHOCK HAZARD, DO NOT EXPOSE THIS PRODUCT TO RAIN OR MOISTURE.

WARNING: Do not install this equipment in a confined space such as a book case or similar unit.

CAUTION: The apparatus shall not be exposed to water (dripping or splashing) and no objects filled with liquids, such as vases, shall be placed on the apparatus.

CAUTION: Do not use high voltage products around this product. (ex. Electrical swatter) This product may malfunction due to electrical shock.

CAUTION: Do not block any ventilation openings. Install in accordance with the manufacturer's instructions.

Slots and openings in the cabinet are provided for ventilation and to ensure reliable operation of the product and to protect it from over heating. The openings shall be never be blocked by placing the product on a bed, sofa, rug or other similar surface. This product shall not be placed in a builtin installation such as a bookcase or rack unless proper ventilation is provided or the manufacturer's instruction has been adhered to.



CAUTION : This product employs a Laser System. To ensure proper use of this product, please read this owner's manual carefully and retain it for future reference. Shall the unit require maintenance, contact an authorized service center. Use of controls, adjustments or the performance of procedures other than those specified herein may result in hazardous radiation exposure. To prevent direct exposure to laser beam, do not try to open the enclosure. Visible laser radiation when open. DO NOT STARE INTO BEAM.

CAUTION concerning the Power Cord

Most appliances recommend they be placed upon a dedicated circuit;

That is, a single outlet circuit which powers only that appliance and has no additional outlets or branch circuits. Check the specification page of this owner's manual to be certain. Do not overload wall outlets. Overloaded wall outlets, loose or damaged wall outlets, extension cords, frayed power cords, or damaged or cracked wire insulation are dangerous. Any of these conditions could result in electric shock or fire. Periodically examine the cord of your appliance, and if its appearance indicates damage or deterioration, unplug it, discontinue use of the appliance, and have the cord replaced with an exact replacement part by an authorized service center. Protect the power cord from physical or mechanical abuse, such as being twisted, kinked, pinched, closed in a door, or walked upon. Pay particular attention to plugs, wall outlets, and the point where the cord exits the appliance. The Power Plug is the disconnecting device. In case of an emergency, the Power Plug must remain readily accessible.

This device is equipped with a portable battery or accumulator.

Safe way to remove the battery or the battery from the equipment:

Remove the old battery pack, follow the steps in reverse order than the assembly. To prevent contamination of the environment and bring on possible threat to human and animal health, the old battery or the battery put in the appropriate container at designated collection points. Do not dispose of batteries or battery together with other waste. It is recommended that you use local, free reimbursement system batteries and accumulators. The battery shall not be exposed to excessive heat such as sunshine, fire or the like.

Disposal of your old appliance



1. All electrical and electronic products shall be disposed of separately from the municipal waste stream via designated collection facilities appointed by the government or the local authorities.
2. The correct disposal of your old appliance will help prevent potential negative consequences for the environment and human health.
3. For more detailed information about disposal of your old appliance, please contact your city office, waste disposal service or the shop where you purchased the product.

Disposal of waste batteries/accumulators



Pb

1. This symbol may be combined with chemical symbols for mercury(Hg), cadmium(Cd) or lead(Pb) if the battery Contains more than 0.0005% of mercury, 0.002% of cadmium or 0.004% of lead.
2. All batteries/accumulators should be disposed separately from the municipal waste stream via designated collection facilities appointed by the government or the local authorities.
3. The correct disposal of Your old batteries/ accumulators will help to prevent potential negative consequences for the environment, animal and human health.
4. For more detailed information about disposal of Your old batteries/ accumulators, please contact Your city office, waste disposal service or the shop where You purchased the product.

POWER: This unit operates on a mains supply of 200-240V~, 50/60Hz.

Wiring: This unit is supplied with a BS 1363 approved main plug. When replacing the fuse, always use of the same rating approved to BS 1362. Never use this plug with the fuse cover omitted. To obtain a replacement fuse cover contact your dealer. If the type of plug supplied is not suitable for the mains sockets in your home, then the plug should be removed and a suitable type fitted. Please refer to the wiring instructions below:

Warning: A mains plug removed from the mains lead of this unit must be destroyed. A mains plug with bared wires is hazardous if inserted in a mains socket. Do not connect either wire to the earth pin, marked with the letter E or with the earth symbol **6** or coloured green or green and yellow. If any other plug is fitted, use same rating of fuse in the plug.

Important: The wires in this mains lead are coloured in accordance with the following codes:

- **BLUE: NEUTRAL, BROWN: LIVE** - As the colours of the wires in the mains lead of this unit may not correspond with the coloured marking identifying the terminals in your plug, proceed as follows: The wire which is coloured blue must be connected to the terminal which is marked with the letter N or coloured black. The wire which is coloured brown must be connected to the terminal which is marked with the letter L or coloured red.

Contact office for compliance of this product:

LG Electronics European Shared Service Center
B.V. European Standard Team
Krijgsmans 1 1186 DM Amstelveen
The Netherlands

Table of Contents

1 Getting Started

- 2 Safety Information
- 6 Introduction
 - 6 - Accessories
 - 6 - Playable Discs
 - 6 - About the  Symbol Display
 - 6 - Symbol Used in this Manual
 - 6 - Regional Codes
 - 7 - Playable file Requirement
- 9 Front panel
- 9 Rear panel
- 10 Remote control

2 Connecting

- 11 Connecting the speakers
 - 11 - Attaching the speakers to the unit
 - 11 - Positioning the System
- 12 Connections to Your TV
 - 12 - Video Connection
- 12 Optional Equipment Connection
 - 12 - AUX IN Connection
- 13 - USB Connection
- 13 - Antenna Connection

3 System Setting

- 14 Adjust the Setup settings
 - 14 - OSD Initial language settings - Optional
 - 14 - To display and exit the Setup Menu
 - 14 - LANGUAGE
 - 15 - DISPLAY
 - 15 - AUDIO
 - 16 - LOCK (Parental Control)
 - 17 - OTHERS

4 Operating

- 18 Basic Operations
- 19 Other Operations
 - 19 - Displaying Disc Information on-screen
 - 19 - To display the DVD Menu
 - 19 - To display the DVD Title
 - 19 - Selecting a subtitle language
 - 19 - 1.5 times speed playback
 - 19 - Resume playback
 - 20 - Starting play from selected time
 - 20 - Last Scene Memory
 - 20 - Power Resume - Optional
 - 20 - Changing the character set to display DivX® subtitle correctly
 - 20 - Programmed Playback
 - 21 - Viewing a PHOTO file
 - 21 - Viewing photo files as a slide show
 - 21 - Listening to music during slide show
 - 21 - Sleep Timer Setting
 - 21 - Dimmer
 - 21 - Turn off the sound temporarily
 - 21 - Auto Power Down
 - 22 - Screen Saver
 - 22 - System Select - Optional
 - 22 - Displaying file information (ID3 TAG)
- 22 Radio Operations
 - 22 - Listening to the Radio
 - 22 - Presetting the Radio Stations
 - 22 - Deleting all the saved stations
 - 22 - Improving poor FM reception
- 23 Sound adjustment
 - 23 - Setting the surround mode

5 Troubleshooting

24 Troubleshooting

6 Appendix

25 Maintenance
25 - Handling the Unit
25 - Notes on Discs
26 Area Code List
27 Language Code List
28 Trademarks and Licenses
29 Specifications

1

2

3

4

5

6

7

Introduction

Accessories

Please check and identify the supplied accessories.



Remote Control (1)/
Batteries (2)

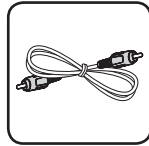

Video Cable (1)

Playable Discs

This unit plays DVD±R/RW and CD-R/RW that contains audio titles, DivX, MP3, WMA and/or JPEG files. Some DVD±RW/DVD±R or CD-RW/CD-R cannot be played on this unit due to the recording quality or physical condition of the disc, or the characteristics of the recording device and authoring software.

	DVD-VIDEO (8 cm / 12 cm disc) Discs such as movies that can be purchased or rented.
	DVD±R (8 cm / 12 cm disc) Video mode and finalized only.
	DVD-RW (8 cm / 12 cm disc) Video mode and finalized only.
	DVD+R: Video mode only. Supports the double layer disc also.
	DVD+RW (8 cm / 12 cm disc) Video mode and finalized only.
	Audio CD: Music CDs or CD-R/CD-RW in music CD format that can be purchased.

About the Symbol Display

"" may appear on your TV display during operation and indicates that the function explained in this owner's manual is not available on that disc.

Symbol Used in this Manual

	DVD-Video, DVD±R/RW in Video mode and finalized
	Audio CDs
	Video files contained in the USB/Disc
	Audio files contained in the USB/Disc
	Photo files

Note

Indicates special notes and operating features.

Caution

Indicates cautions for preventing possible damages from abuse.

Regional Codes

This unit has a regional code printed on the rear of the unit. This unit can play only DVD discs labeled same as the rear of the unit or "ALL".

- Most DVD discs have a globe with one or more numbers in it clearly visible on the cover. This number must match your unit's regional code; or the disc cannot play.
- If you try to play a DVD with a different regional code from your unit, the message "Check Regional Code" appears on the TV screen.

Playable file Requirement

Music file requirement

MP3/ WMA file compatibility with this unit is limited as follows :

- Sampling frequency : within 8 k to 48 kHz (MP3), within 22.05 k to 48 kHz (WMA)
- Bit rate : within 8 k to 320 kbps (MP3), 32 k to 192 kbps (WMA)
- Support Version : v2, v7, v8, v9
- Maximum files : Under 650
- File extensions : ".mp3"/ ".wma"
- CD-ROM file format : ISO 9660/ JOLIET
- We recommend that you use Easy-CD Creator, which creates an ISO 9660 file system.
- You have to set the disc format option to [Mastered] in order to make the discs compatible with the LG players when formatting rewritable discs. When setting the option to Live File System, you cannot use it on LG players. (Mastered/ Live File System : Disc format system for Windows Vista)

The DTS is not supported. In case of DTS audio format, audio is not output.

Photo file requirement

JPEG disc compatibility with this unit is limited as follows :

- Max pixel in width : 2760 x 2048 pixel
- Maximum files : Under 650
- Some discs may not operate due to a different recording format or the condition of disc.
- File extensions: ".jpg"
- CD-ROM file format : ISO 9660/ JOLIET

DivX file requirement

DivX file compatibility with this unit is limited as follows :

- Available resolution: within 720 x 576 (W x H) pixels.
- The file name of the DivX subtitle should be entered within 45 characters.
- Playable video file bit rate : 7 Mbps and under.
- If there is impossible code to express in the DivX file, it may be displayed as " _ " mark on the display.
- Frame rate : less than 30 fps.
- If the video and audio structure of recorded files is not interleaved, either video or audio is outputted.
- Playable DivX file : ".avi", ".mpg", ".mpeg", ".divx"
- Playable Subtitle format : SubRip (*.srt/ *.txt), SAMI (*.smi), SubStation Alpha (*.ssa/ *.txt), MicroDVD (*.sub/ *.txt), SubViewer 2.0 (*.sub/ *.txt), Vobsub (*.sub)
- Playable Codec format : "DIVX 3.11", "DIVX4", "DIVX5", "DIVX6", "MP4V3", "3IVX"
- Playable Audio format : "AC3", "PCM", "MP3", "WMA".
- Sampling frequency : within 8 k to 48 kHz (MP3), within 22.05 k to 48 kHz (WMA)
- Bit rate : within 8 k to 320 kbps (MP3), 32 k to 192 kbps (WMA)
- For Discs formatted in Live file system, you can not it on this unit.
- If the name of movie file is different from that of the subtitle file, during playback of a DivX file, subtitle may not be display.
- If you play a DivX file different from the DivXspec, it may not operate normally.

Compatible USB Devices

- MP3 Player : Flash type MP3 player.
- USB Flash Drive : Devices that support USB2.0 or USB1.1.
- The USB function of this unit does not support some USB devices.

USB device requirement

- Devices which require additional program installation connected to a computer, are not supported.
- Do not extract the USB device while in operation.
- For a large capacity USB, it may take longer than a few minute to be searched.
- To prevent data loss, back up all data.
- If you use a USB extension cable or USB hub, the USB device is not recognized.
- Using NTFS file system is not supported. (Only FAT(16/32) file system is supported.)
- This unit is not supported when the total number of files is 1000 or more.
- External HDD, Card readers, Locked devices, or hard type USB devices are not supported.
- USB port of the unit cannot be connected to PC. The unit can not be used as a storage device.
- Some USB may not work with this unit.

Front panel

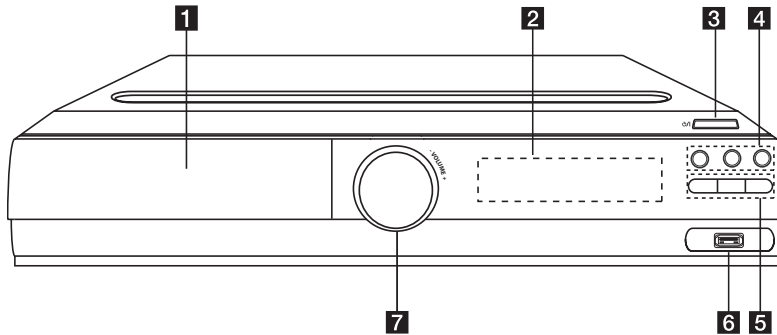

1 DVD/CD Disc Drawer

2 Display window

3 (Power)

4 (Open/Close)

(Play/Pause)

(Stop)

5 (Skip/Search)

You can skip and search chapter/ track/ file by pressing and holding .

TUNING (-/+)

Tunes in the desired radio station.

FUN (FUNCTION)

Selects the function or input source.

6 USB port

7 **VOLUME (-/+)**

Rear panel

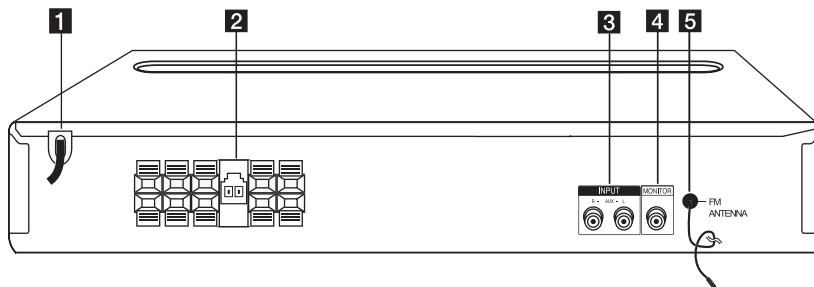

1 Power cord

2 Speaker connector

3 **AUX (L/ R) INPUT** connector

4 **MONITOR (VIDEO OUT)** connector
Connect to a TV with video inputs.

5 **FM ANTENNA**

1

Getting Started

Remote control

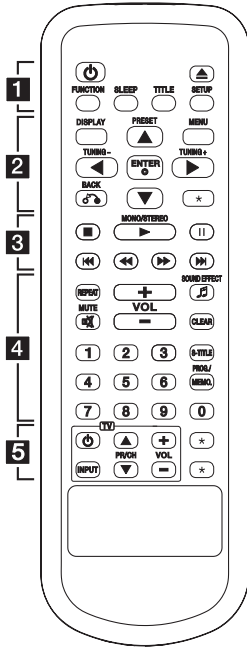

Replacement of battery

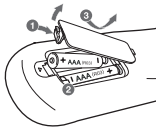

Remove the battery cover on the rear of the Remote Control, and insert one (size AAA) battery with **+** and **-** matched correctly.

..... **1**

⏻ (POWER) : Switches the unit ON or OFF.

⏏ (OPEN/CLOSE) : Opens and closes the disc Drawer.

FUNCTION : Selects the function and input source.

SLEEP : Sets the system to turn off automatically at a specified time. (Dimmer : The display window will be darkened by half.)

TITLE : If the current DVD title has a menu, the title menu appears on the screen. Otherwise, the disc menu may not appear.

SETUP : Accesses or removes setup menu.

..... **2**

DISPLAY : Accesses On-Screen Display.

MENU : Accesses the menu on a DVD disc.

PRESET (▲/▼) : Selects programme of Radio.

TUNING (-/+) : Tunes in the desired radio station.

▲/▼/◀/▶ (up/ down/ left/ right): Used to navigate on-screen displays.

ENTER (⊙) : Acknowledges menu selection.

BACK (↶) : Moves backwards in the menu or exits the setup menu.

*****: This button is not available.

..... **3**

■ (STOP) : Stops playback.

▶ (PLAY) MONO/STEREO : Starts playback. Selects Mono/ Stereo.

|| (PAUSE) : Pauses playback.

⏮/⏭ (SKIP) : Goes to next or previous chapter/ track/ file.

⏪/⏩ (SCAN) : Searches backward or forward.

..... **4**

REPEAT: Selects a play mode. (Random, repeat)

VOL (Volume) (+/-) : Adjusts speaker volume.

SOUND EFFECT (🎵) : Chooses sound impressions.

MUTE (🔇) : Mutes the sound.

CLEAR : Removes a track number on the Program List.

S-TITLE : During playback, press **S-TITLE** repeatedly to select a desired subtitle language .

0 to 9 numerical buttons : Selects numbered options in a menu.

PROG./MEMO. : Accesses or removes Program menu.

..... **5**

TV Control buttons : Controls the TV. (LG TV only)

- You can control the sound level, input source, and power switching of LG TVs as well. Hold **POWER (TV)** and press **PR/CH (+/-)** button repeatedly until the TV turns on or off.

*****: This button is not available.

Connecting the speakers

Attaching the speakers to the unit

To connect the cable to the unit, press each plastic finger pad to open the connection terminals on the unit. Insert the wire and release the finger pad.

Connect the black wire to the terminals marked - (minus) and the other end to the terminals marked + (plus).

Speaker connection

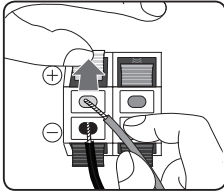

Connect a woofer cord to the player. When connecting a woofer cord to the player, insert the connector until it clicks.

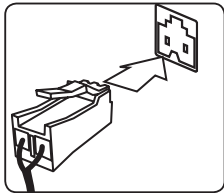

Caution

- Be careful to make sure children not to put their hands or any objects into the *speaker duct.
- *Speaker duct: A hole for plentiful bass sound on speaker cabinet (enclosure).
- The speakers contain magnet parts, so color irregularity may occur on the TV screen or PC monitor screen. Please use the speakers far away from either TV screen or PC monitor.

Positioning the System

The following illustration shows an example of positioning the system.

Note that the illustrations in these instructions differ from the actual unit for explanation purposes.

For the best possible surround sound, all the speakers other than the subwoofer should be placed at the same distance from the listening position (A).

Speaker Positioning

- Ⓐ Front left speaker (L)/ Ⓑ Front right speaker (R): Place the front speakers to the sides of the monitor or screen and as flush with the screen surface as possible.
- Ⓒ Center speaker: Place the center speaker above or below the monitor or screen.
- Ⓓ Surround left speaker (L)/ Ⓔ Surround right speaker (R): Place these speakers behind your listening position, facing slightly inwards.
- Ⓕ Subwoofer: The position of the subwoofer is not so critical, because low bass sounds are not highly directional. But it is better to place the subwoofer near the front speakers. Turn it slightly toward the center of the room to reduce the wall reflections.
- Ⓖ Unit

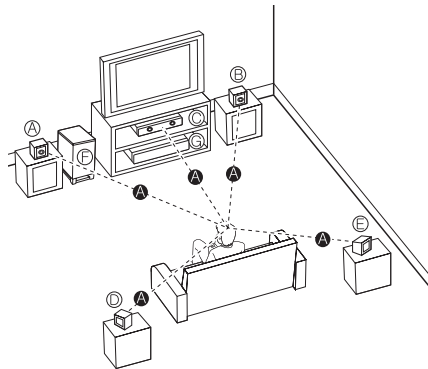

Connections to Your TV

Make one of the following connections, depending on the capabilities of your existing equipment.

! Note

- Depending on your TV and other equipment you wish to connect, there are various ways you could connect the player. Use only one of the connections described in this manual.
- Please refer to the manuals of your TV, Stereo System or other devices as necessary to make the best connections.

! Caution

- Make sure the unit is connected directly to the TV. Tune the TV to the correct video input channel
- Do not connect your player via your VCR. The image could be distorted by the copy protection system.

Video Connection

Connect the MONITOR jack on the unit to the video in jack on the TV using a video cable.

You can hear the sound through the system's speakers.

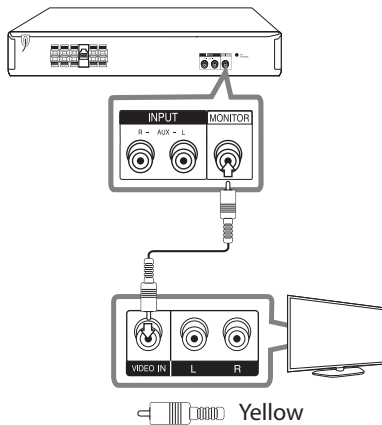

Optional Equipment Connection

AUX IN Connection

Connect an Output of auxiliary device to the AUX (L/R) INPUT Connector.

If your TV has only one output for audio (mono), connect it to the left (white) audio jack on the unit.

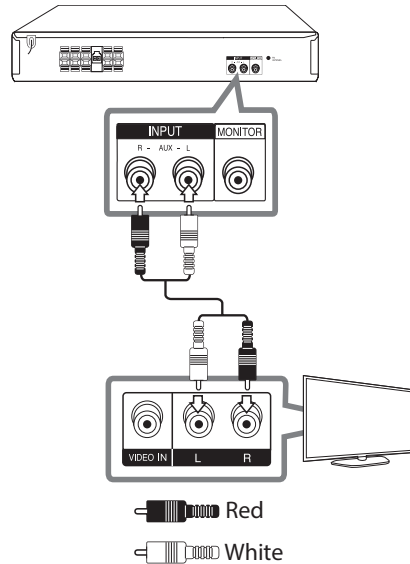

USB Connection

Connect the USB port of USB Memory (or MP3 player, etc.) to the USB port on the front of the unit.

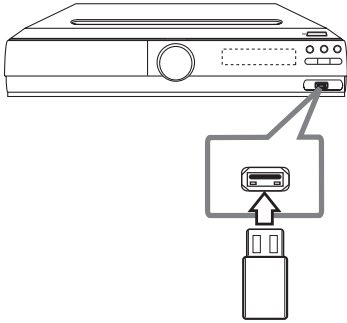

! Note

Removing the USB Device from the unit

1. Choose a different function mode or press **■** twice in a row.
2. Remove the USB device from the unit.

Antenna Connection

Be sure to fully extend the FM wire antenna.

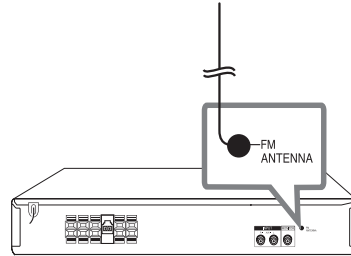

Adjust the Setup settings

By using the Setup menu, you can make various adjustments to items such as picture and sound.

You can also set a language for the subtitles and the Setup menu, among other things. For details on each Setup menu item, see pages 14 to 17.

OSD Initial language settings - Optional

During the first use of this unit, the initial language setup menu appears on your TV screen. You must complete initial language selection before using the unit. English will be selected as the initial language.

1. Press **⏻** (POWER) to turn the unit on. The language setup menu will appear on the screen.

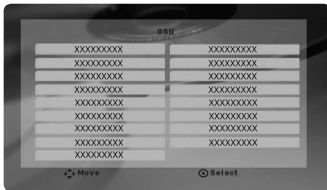

2. Use **▲/▼/◀/▶** to select a language then press **ENTER**. The confirm menu will appear.



3. Use **◀/▶** to select the [Enter] then press **ENTER** to finish the language setup.

To display and exit the Setup Menu

1. Select the DVD/CD or USB function by pressing **FUNCTION**.
2. Press **SETUP**. Displays the [Setup] Menu.
3. Press **SETUP** or **BACK** to exit in the [Setup] Menu.

About help menu for Setup

Menu	Buttons	Operation
▲/▼ Move	▲/▼	Moving to another menu.
◀ Prev.	◀	Moving to previous level.
▶ Select	▶	Moving to next level or selecting menu.
🔙	BACK	To exit the [Setup] menu or [5.1 Speaker Setup].
⊙	ENTER	To confirm menu.

LANGUAGE

Menu Language

Select a language for the Setup menu and then on screen display.

Disc Audio / Disc Subtitle / Disc Menu

Select the language you prefer for the audio track (disc audio), subtitles, and the disc menu.

[Original]

Refers to the original language in which the disc was recorded.

[Other]

To select another language, press numeric buttons and then **ENTER** to enter the corresponding 4-digit number according to the language code list on the page 27. If you enter the wrong language code, press **CLEAR**.

[Off (for Disc Subtitle)]

Turn off Subtitle.

DISPLAY**TV Aspect**

Select which screen aspect to use based on the shape of your TV screen.

[4:3]

Select when a standard 4:3 TV is connected.

[16:9]

Select when a 16:9 wide TV is connected.

Display Mode

The Display Mode setting works only when the TV Aspect mode is set to 4:3.

[Letterbox]

Displays a wide picture with bands on the upper and lower portions of the screen.

[Panscan]

Automatically displays the wide picture on the entire screen and cuts off the portions that do not fit. (If the disc/file is not compatible with Pan Scan, the picture is displayed at Letterbox ratio.)

AUDIO**DRC (Dynamic Range Control)**

Make the sound clear when the volume is turned down (Dolby Digital only). Set to [On] for this effect.

Vocal

Select [On] to mix karaoke channels into normal stereo.

This function is effective for multi-channel karaoke DVDs only.

5.1 Speaker Setup

Make the following settings for the built-in 5.1 channel surrounds decoder.

1. Press **SETUP**.
2. Use **▲/▼** to select AUDIO menu and then press **▶**.
3. Use **▲/▼** to select [5.1 Speaker setup] menu and then press **▶**.
4. Press **ENTER**
The [5.1 Speaker setup] appears.



5. Use **◀/▶** to select the desired speaker.
6. Adjust options using **▲/▼/◀/▶** buttons.
7. Press **BACK** to confirm your selection. Return to the previous menu.

[Speaker]

Select a speaker that you want to adjust.

! Note

Certain speaker settings are prohibited by the Dolby Digital licensing agreement.

[Size]

Since the speaker settings are fixed, you cannot change the settings.

[Volume]

Press ◀/▶ to adjust the output level of the selected speaker.

[Distance]

Adjust the distance between each speaker and the listening position.

[Test]

Press ◀/▶ to test the signals of each speaker. Adjust the volume to match the volume of test signals memorized in the system.

LOCK (Parental Control)**Initial Setting of the Area Code:**

When you use this unit for the first time, you have to set the Area Code.

1. Select the [Lock] menu and then press ▶.
2. Press ▶.
To access the [Lock] options, you must input the password you have created. Input a password and press **ENTER**. Enter it again and press **ENTER** to verify. If you make a mistake before pressing **ENTER**, press **CLEAR**.
3. Select the first character using ▲/▼ buttons.
4. Press **ENTER** and select the second character using ▲/▼ buttons.
5. Press **ENTER** to confirm your Area code selection.

Rating

Blocks playback of rated DVDs based on their contents. Not all discs are rated.

1. Select [Rating] on the [Lock] menu then press ▶.
2. Input a password and press **ENTER**.
3. Select a rating from 1 to 8 using the ▲/▼ buttons.

[Rating 1-8]

Rating one (1) has the most restrictions and rating eight (8) is the least restrictive.

[Unlock]

If you select unlock, parental control is not active and the disc plays in full.

4. Press **ENTER** to confirm your rating selection.

Password

You can enter or change password.

1. Select [Password] on the [Lock] menu and then press ▶.
2. Input a password and press **ENTER**.
To change the password, press **ENTER** when the [Change] option is highlighted. Input a password and press **ENTER**. Enter it again and press **ENTER** to verify.
3. Press **SETUP** to exit the menu.

Note

If you forget your password, you can clear it using the following steps:

1. Press **SETUP** to display the Setup menu.
2. Input the 6-digit number "210499" and press **ENTER**. The password is cleared.

Area Code

Enter the code of the area whose standards were used to rate the DVD video disc, based on the list on page 26.

1. Select [Area Code] on the [Lock] menu then press ►.
2. Input a password and press **ENTER**.
3. Select the first character using ▲/▼ buttons.
4. Press **ENTER** and select the second character using ▲/▼ buttons.
5. Press **ENTER** to confirm your Area code selection.

OTHERS

DivX(R) VOD

ABOUT DIVX VIDEO: DivX® is a digital video format created by DivX, LLC, a subsidiary of Rovi Corporation. This is an official DivX Certified® device that has passed rigorous testing to verify that it plays DivX video. Visit divx.com for more information and software tools to convert your files into DivX videos.

ABOUT DIVX VIDEO-ON-DEMAND: This DivX Certified® device must be registered in order to play purchased DivX Video-on-Demand (VOD) movies. To obtain your registration code, locate the DivX VOD section in your device setup menu. Go to vod.divx.com for more information on how to complete your registration.

[Register]

Displays the registration code of your unit.





[Deregister]

Deactivate your unit and display the deactivation code.

Note

All the downloaded videos from DivX VOD can only be played back on this unit.

Basic Operations













1. Insert the disc by pressing  or connect the USB device to the USB port.
2. Select the DVD/ CD or USB function by pressing **FUNCTION**.
3. Select a file (or track/ title) you want to play by pressing ///.

Note

When playing a disc or USB Flash Drive containing with DivX, MP3/ WMA and JPEG files together, you can select menu of files which you would like to play by pressing **MENU**. If "This file has non-supported type on the unit" pops up, select an appropriate file by pressing **MENU**.

4

Operating

To	Do this
Stop	Press  STOP .
Playback	Press  PLAY .
Pause	Press  PAUSE .
Frame-by-Frame playback	Press  PAUSE repeatedly to play title Frame-by-Frame.
Skipping to the next/previous chapter/track/ file	During playback, press  /  SKIP to go to the next chapter/track or to return to the beginning of the current chapter/track. Press  twice briefly to step back to the previous chapter/ track.
Locating a point quickly by playing a file in fast forward or fast reverse	During playback, press  /  SCAN repeatedly to select the required scan speed. To return to normal speed, press  PLAY .
Playing repeatedly	Press REPEAT/RANDOM repeatedly, and the current title, chapter or track will be played back repeatedly or randomly. - Random play mode : only music files.
Slowing down the playing speed	In the pause mode, press  /  SCAN to select the required speed. (The reverse playback is not supported on DivX files.)

Other Operations

Displaying Disc Information on-screen

You can display various information about the disc loaded on-screen.

1. Press **DISPLAY** to show various playback information.
The displayed items differ depending on the disc type or playing status.
2. You can select an item by pressing **▲/▼** and change or select the setting by pressing **◀/▶**.

Title – Current title number/ total number of titles.

Chapter – Current chapter number/total number of chapters.

Time – Elapsed playing time. When you put cursor in "Time" menu, you can check total playing time. on botton menu.

Audio – Selected audio language or channel.

Subtitle – Selected subtitle.

Angle – Selected angle/total number of angles.

Sound – Selected sound mode.

Note

If any button is not pressed for a few seconds, the onscreen display disappears.

To display the DVD Menu

DVD

When you play a DVD which contains several menus, you can select the menu you want using the menu.

1. Press **MENU**.
The disc's menu appears.
2. Select the menu by using **▲/▼/◀/▶**.
3. Press **▶** to confirm.

To display the DVD Title

DVD

When you play a DVD which contains several titles, you can select the title you want using the menu.

1. Press **TITLE**.
The disc's title appears.
2. Select the menu by pressing **▲/▼/◀/▶**.
3. Press **▶** to confirm.

Selecting a subtitle language

DVD MOVIE

During playback, press **S-TITLE** repeatedly to select a desired subtitle language.

1.5 times speed playback

DVD

The 1.5 speed allows you to watch the pictures and listen to the sound quicker than playing at a normal speed.

1. During playback, press **▶** to play at 1.5 times speed. "▶X1.5" appears on the screen.
2. Press **▶** again to exit.

Resume playback

DVD MOVIE MUSIC ACD

The unit records the point where you pressed the **■** depending on the disc.

If "**||■**" (Resume Stop) appears on the screen briefly, press **▶** to resume playback (from the scene point).

If you press **■** twice or unload the disc, "**■**" (Complete Stop) appears on the screen. The unit will clear the stopped point.

Note

- The resume point may be cleared when a button is pressed (for example; **POWER**, **▲**, etc).
- This function may not work on some disc or title/track.

Starting play from selected time

DVD MOVIE

To start playing at any chosen time on the file or title.

1. Press **DISPLAY** during playback.
2. Press **▲/▼** to select the time clock icon and "----:" appears.
3. Input the required start time in hours, minutes, and seconds from left to right. If you enter the wrong numbers, press **CLEAR** to remove the numbers you entered. Then input the correct numbers.
For example, to find a scene at 1 hour, 10 minutes, and 20 seconds, enter "11020" by using numerical buttons.
4. Press **ENTER** to confirm. Playback starts from the selected time.

Last Scene Memory

DVD

This unit memorizes the last scene from the last disc that is viewed. The last scene remains in memory even if you remove the disc from the player or switch off (Stand-by mode) the unit. If you load a disc that has the scene memorized, the scene is automatically recalled.

Power Resume - Optional

DVD

Even if the power suddenly goes out, turn on the unit and then it plays a position where the contents is being played. System will periodically save current playback status.

Changing the character set to display DivX® subtitle correctly

MOVIE

If the subtitle does not display properly during playback press and hold **S-TITLE** for about 3 seconds then press **◀/▶** or **S-TITLE** to select another language code until the subtitle is displayed properly and then press **ENTER**.

Programmed Playback

ACD MUSIC

The program function enables you to store your favourite files from any disc or USB device.

A program can contain 30 tracks/ files.

1. Select the DVD/CD or USB function by pressing **FUNCTION**.
2. To add a music(s) on the program list, press **PROG./MEMO**. to enter the program edit mode (ⓔ icon appears on the menu).
3. Select a desired music on the [List] by using the **▲/▼** then press **ENTER** to add the music to the program list.
4. Select music from the program list then press **ENTER** to start programmed playback.
5. Press **PROG./MEMO**. to exit the program edit mode (ⓔ icon disappears on the menu).

Erasing a file from Program List

1. Press **PROG./MEMO**. to enter the program edit mode (ⓔ icon appears on the menu).
2. Use **▲/▼** to select the track that you wish to erase from the Program list.
3. Press **CLEAR**.

Erasing the Complete Program List

Use **▲/▼/◀/▶** to select [Clear All] then press **ENTER**.

! Note

The programs are also cleared when the disc or USB device is removed, the unit is switched to power off or the function is switched to others.

Viewing a PHOTO file



PHOTO

This unit can play discs with photo files.

1. Select the DVD/CD or USB function by pressing **FUNCTION**.
2. Press **▲/▼** to select a folder, and then press **ENTER**.
A list of files in the folder appears.
If you want to return to the previous folder list, use the **▲/▼** buttons on the remote to highlight  and press **ENTER**.
3. If you want to view a particular file, press **▲/▼** to highlight a file and press **ENTER** or **▶**. While viewing a file, you can press **■** to move to the previous menu (JPEG menu).

Viewing photo files as a slide show

PHOTO

1. Use **▲/▼/◀/▶** to highlight () icon then press **ENTER** to start slide Show.
2. You can change slide show speed using **◀/▶** when () icon is highlighted.

About help menu for slide show

Menu	Buttons	Operation
▲/▼ ↶90° / ↷90°	▲/▼	Rotating the picture
◀◀/▶▶ Prev./ Next	◀/▶	Moving to another file
 Hide	BACK	Hiding the help menu
■	STOP	Closing the slide show

Listening to music during slide show

PHOTO

You can listen to music during slide show, if the disc contain music and photo files together. Use **▲/▼/◀/▶** to highlight () icon then press **ENTER** to start slide show.

! Note

This function is available only in disc.

Sleep Timer Setting

Press **SLEEP** one or more times to select delay time between 10 and 180 minutes, after the unit will turn off.

To check the remaining time, press **SLEEP**.

To cancel the sleep function, press **SLEEP** repeatedly until "SLEEP 10" appears, and then press **SLEEP** once again while "SLEEP 10" is displayed.

! Note

You can check the remaining time before the unit turns off.

Dimmer

Press **SLEEP** once. The display window will be darken by half. To cancel it, press **SLEEP** repeatedly until dimmer gets off.

Turn off the sound temporarily

Press **MUTE** () to mute your unit.

You can mute your unit, for example, to answer the telephone, the "MUTE" displayed in the display window.

Auto Power Down

This unit will power off itself to save electric consumption in the case main unit is not connected to external device and is not used for 20 minutes.

This unit will power off after six hours when connected to a device using an analog input.

Screen Saver

The screen saver appears when you leave the unit in stop mode for about five minutes.

System Select - Optional

You must select the appropriate system mode for your TV system. If "NO DISC" or "NO USB" appears in the display window, press and hold **II** for more than five seconds to select a system. (AUTO/NTSC/PAL)

Displaying file information (ID3 TAG)

While playing an MP3 file containing file information, you can display the information by pressing **DISPLAY**.

4

Operating

Radio Operations

Be sure to fully extend the FM wire antenna.

Listening to the Radio

1. Press **FUNCTION** until FM appears in the display window.
The last received station is tuned in.
2. Press and hold **TUNING (-/+)** for about two seconds until the frequency indication starts to change, then release. Scanning stops when the unit tunes in a station.

or

Press **TUNING (-/+)** repeatedly.

3. Adjust the volume by rotating **VOLUME(-/+)** on the front panel or by pressing **VOL +** or **-** on the remote control repeatedly.

Presetting the Radio Stations

You can preset 50 stations for FM.

Before tuning, make sure that you have turned down the volume.

1. Press **FUNCTION** until FM appears in the display window.
2. Select the desired frequency by using **TUNNING (-/+)**.
3. Press **PROG./MEMO**. a preset number will flash in the display window.
4. Press **PRESET (▲/▼)** to select the preset number you want.
5. Press **PROG./MEMO**.
The station is stored.
6. Repeat the steps 2 to 5 to store other stations.

Deleting all the saved stations

1. Press and hold **CLEAR** for two seconds.
"CLEAR" will flash up on the unit display.
2. Press **CLEAR** to erase all of the saved radio stations.

Improving poor FM reception

Press **▶** on the remote control. This will change the tuner from stereo to mono and usually improve the reception.

Sound adjustment

Setting the surround mode

This system has a number of pre-set surround sound fields. You can select a desired sound mode by using **SOUND EFFECT**. You can change the sound effect using ◀/▶ arrow key while the sound effect information is displayed on.

The displayed items for the Equalizer may be different depending on sound sources and effects

On Display	Description
NAT PLUS	You can enjoy the natural sound effect same as a 5.1-channel.
NATURAL	You can enjoy comfortable and natural sound.
Local Specialization equalizer -Optional	Regionally optimized sound effect. (DANGDUT/ ARABIC/ PERSIAN/ INDIA/ REGUETON/ MERENGUE/ SALSA/ SAMBA/ CUMBIA/ AFRO)
POP CLASSIC JAZZ ROCK	This program lends an enthusiastic atmosphere to the sound, giving you the feeling you are at an actual pop, classic, jazz or rock concert.
BASS	During playback, Reinforces the treble, bass and surround sound effect.
LOUDNESS	Improves the bass and treble sound.
BYPASS	You can enjoy the sound without equalizer effect.
P-FRONT (POWER FRONT) -Optional	You can enjoy the harmonious sound. This mode is suited for front-positioned speakers when they are all placed in a row.

! Note

- In some of surround modes, on some speakers, there's no sound or low sound. it, depends on the mode of surround and the source of audio, it is not defective.
- You may need to reset the surround mode, after switching the input, sometimes even after the sound track changed.

Troubleshooting

PROBLEM	CORRECTION
The unit does not work properly.	<ul style="list-style-type: none"> • Turn off the power of this unit and the connected external device (TV, Woofer, DVD-player, Amplifier, etc.) and turn it on again. • Disconnect the power cord of this unit and the connected external device (TV, Woofer, DVD-player, Amplifier, etc.) and then try connecting again.
No power	<ul style="list-style-type: none"> • Plug the power cord into the wall outlet securely.
No picture	<ul style="list-style-type: none"> • Select the appropriate video input mode on the TV so the picture from the unit appears on the TV screen. • Connect the video cables securely to both the TV and unit.
There is little or no sound	<ul style="list-style-type: none"> • Select the correct input mode of the unit so you can hear the sound from the unit. • Connect the audio cables into the connection terminals correctly. • Replace with a new audio cable.
The DVD picture quality is poor	<ul style="list-style-type: none"> • Clean the disc using a soft cloth with outward strokes.
A DVD/CD will not play	<ul style="list-style-type: none"> • Insert a disc. • Insert a playable disc (check the disc type, colour system and regional code). • Place the disc with the label or printed side facing upwards. • Enter your password or change the rating level.
Humming noise heard while a DVD or CD is playing	<ul style="list-style-type: none"> • Clean the disc using a soft cloth with outward strokes. • Move unit and audio components further away from your TV.
Radio stations can't be tuned in properly.	<ul style="list-style-type: none"> • Check the antenna position. • Attach an external antenna if necessary. • Tune to the station manually. • Preset some radio stations, see page 22 for details.
The remote control doesn't work well / at all	<ul style="list-style-type: none"> • The remote is not pointed directly at the unit. Point the remote directly at the unit. • The remote is too far from the unit. Use the remote within 7 m of the unit. • There is an obstacle in the path between the remote control and the unit. Remove the obstacle. • The battery in the remote control are flat. Replace the battery with new ones.

Maintenance

Handling the Unit

When shipping the unit

Please save the original shipping carton and packing materials. If you need to ship the unit, for maximum protection, re-pack the unit as it was originally packed at the factory.

Keeping the exterior surfaces clean

- Do not use volatile liquids such as insecticide spray near the unit.
- Wiping with strong pressure may damage the surface.
- Do not leave rubber or plastic products in contact with the unit for a long period of time.

Cleaning the unit

To clean the player, use a soft, dry cloth. If the surfaces are extremely dirty, use a soft cloth lightly moistened with a mild detergent solution. Do not use strong solvents such as alcohol, benzine, or thinner, as these might damage the surface of the unit.

Maintaining the Unit

The unit is a high-tech, precision device. If the optical pick-up lens and disc drive parts are dirty or worn, the picture quality could be diminished. For details, please contact your nearest authorized service center.

Notes on Discs

Handling Discs

Do not touch the playback side of the disc. Hold the disc by the edges so that fingerprints do not get on the surface. Never stick paper or tape on the disc.

Storing Discs

After playing, store the disc in its case. Do not expose the disc to direct sunlight or sources of heat and never leave it in a parked car exposed to direct sunlight.

Cleaning Discs

Fingerprints and dust on the disc can cause poor picture quality and sound distortion. Before playing, clean the disc with a clean cloth. Wipe the disc from the center to out.

Do not use strong solvents such as alcohol, benzine, thinner, commercially available cleaners, or anti-static spray intended for older vinyl records.

Area Code List

Choose an area code from this list.

Area	Code	Area	Code	Area	Code	Area	Code
Afghanistan	AF	Fiji	FJ	Monaco	MC	Singapore	SG
Argentina	AR	Finland	FI	Mongolia	MN	Slovak Republic	SK
Australia	AU	France	FR	Morocco	MA	Slovenia	SI
Austria	AT	Germany	DE	Nepal	NP	South Africa	ZA
Belgium	BE	Great Britain	GB	Netherlands	NL	South Korea	KR
Bhutan	BT	Greece	GR	Antilles	AN	Spain	ES
Bolivia	BO	Greenland	GL	New Zealand	NZ	Sri Lanka	LK
Brazil	BR	Hong Kong	HK	Nigeria	NG	Sweden	SE
Cambodia	KH	Hungary	HU	Norway	NO	Switzerland	CH
Canada	CA	India	IN	Oman	OM	Taiwan	TW
Chile	CL	Indonesia	ID	Pakistan	PK	Thailand	TH
China	CN	Israel	IL	Panama	PA	Turkey	TR
Colombia	CO	Italy	IT	Paraguay	PY	Uganda	UG
Congo	CG	Jamaica	JM	Philippines	PH	Ukraine	UA
Costa Rica	CR	Japan	JP	Poland	PL	United States	US
Croatia	HR	Kenya	KE	Portugal	PT	Uruguay	UY
Czech Republic	CZ	Kuwait	KW	Romania	RO	Uzbekistan	UZ
Denmark	DK	Libya	LY	Russian Federation	RU	Vietnam	VN
Ecuador	EC	Luxembourg	LU	Saudi Arabia	SA	Zimbabwe	ZW
Egypt	EG	Malaysia	MY	Senegal	SN		
El Salvador	SV	Maldives	MV				
Ethiopia	ET	Mexico	MX				

Language Code List

Use this list to input your desired language for the following initial settings: [Disc Audio], [Disc Subtitle] and [Disc Menu].

Language	Code	Language	Code	Language	Code	Language	Code
Afar	6565	French	7082	Lithuanian	7684	Sindhi	8368
Afrikaans	6570	Frisian	7089	Macedonian	7775	Singhalese	8373
Albanian	8381	Galician	7176	Malagasy	7771	Slovak	8375
Ameharic	6577	Georgian	7565	Malay	7783	Slovenian	8376
Arabic	6582	German	6869	Malayalam	7776	Spanish	6983
Armenian	7289	Greek	6976	Maori	7773	Sudanese	8385
Assamese	6583	Greenlandic	7576	Marathi	7782	Swahili	8387
Aymara	6588	Guarani	7178	Moldavian	7779	Swedish	8386
Azerbaijani	6590	Gujarati	7185	Mongolian	7778	Tagalog	8476
Bashkir	6665	Hausa	7265	Nauru	7865	Tajik	8471
Basque	6985	Hebrew	7387	Nepali	7869	Tamil	8465
Bengali; Bangla	6678	Hindi	7273	Norwegian	7879	Telugu	8469
Bhutani	6890	Hungarian	7285	Oriya	7982	Thai	8472
Bihari	6672	Icelandic	7383	Panjabi	8065	Tonga	8479
Breton	6682	Indonesian	7378	Pashto, Pushto	8083	Turkish	8482
Bulgarian	6671	Interlingua	7365	Persian	7065	Turkmen	8475
Burmese	7789	Irish	7165	Polish	8076	Twi	8487
Byelorussian	6669	Italian	7384	Portuguese	8084	Ukrainian	8575
Chinese	9072	Japanese	7465	Quechua	8185	Urdu	8582
Croatian	7282	Kannada	7578	Rhaeto-Romance	8277	Uzbek	8590
Czech	6783	Kashmiri	7583	Rumanian	8279	Vietnamese	8673
Danish	6865	Kazakh	7575	Russian	8285	Volapük	8679
Dutch	7876	Kirghiz	7589	Samoan	8377	Welsh	6789
English	6978	Korean	7579	Sanskrit	8365	Wolof	8779
Esperanto	6979	Kurdish	7585	Scots Gaelic	7168	Xhosa	8872
Estonian	6984	Laothian	7679	Serbian	8382	Yiddish	7473
Faroese	7079	Latin	7665	Serbo-Croatian	8372	Yoruba	8979
Fiji	7074	Latvian, Lettish	7686	Shona	8378	Zulu	9085
Finnish	7073	Lingala	7678				

Trademarks and Licenses



"DVD Logo" is a trademark of DVD Format/Logo Licensing Corporation.



DivX®, DivX Certified® and associated logos are trademarks of Rovi Corporation or its subsidiaries and are used under license.



Manufactured under license from Dolby Laboratories. Dolby and the double-D symbol are trademarks of Dolby Laboratories.

Notes on Copyrights

- This product incorporates copyright protection technology that is protected by U.S. patents and other intellectual property rights. Use of this copyright protection technology must be authorized by Rovi, and is intended for home and other limited viewing uses only unless otherwise authorized by Rovi. Reverse engineering or disassembly is prohibited.
- Under the U.S. Copyright laws and Copyright laws of other countries, unauthorized recording, use, display, distribution, or revision of television programs, videotapes, BD-ROM discs, DVDs, CDs and other materials may subject you to civil and/or criminal liability.

Specifications

General	
Power requirements	Refer to main label.
Power consumption	Refer to main label.
Dimensions (W x H x D)	Approx. 360 mm X 65 mm X 270 mm without foot
Net Weight (Approx.)	2.15 kg
Operating temperature	5 °C to 35 °C
Operating humidity	5 % to 90 %

Outputs	
VIDEO OUT	1.0 V (p-p), 75 Ω, sync negative, RCA jack x 1
ANALOG AUDIO IN	2.0 Vrms (1 kHz, 0 dB), 600 Ω, RCA jack (L, R) x 1

System	
Laser	Semiconductor laser, wavelength: 650 nm
Signal system	Standard NTSC/ PAL color TV system
Frequency response	20 Hz to 20 kHz (48 kHz, 96 kHz, 192 kHz sampling)
Signal-to-noise ratio	More than 80 dB
Harmonic distortion	0.5 % at 1 W
Dynamic range	More than 80 dB
Bus Power Supply (USB)	5 V  500 mA

Amplifier		
Stereo mode	45 W + 45 W (3 Ω at 1 kHz)	
Surround mode	Front	45 W + 45 W (3 Ω at 1 kHz)
	Center	45 W (3 Ω at 1 kHz)
	Surround	45 W + 45 W (3 Ω at 1 kHz)
	Subwoofer	75 W (6 Ω at 80 Hz)

Tuner	
FM Tuning Range	87.5 to 108.0 MHz or 87.50 to 108.00 MHz

Front Speaker	
Type	1 Way 1 Speaker
Impedance Rated	3 Ω
Input Power	45 W
Max. Input Power	90 W
Net Dimensions (W x H x D)	115 mm x 115 mm x 84 mm
Net Weight	0.3 kg

Rear Speaker	
Type	1 Way 1 Speaker
Impedance Rated	3 Ω
Input Power	45 W
Max. Input Power	90 W
Net Dimensions (W x H x D)	115 mm x 115 mm x 84 mm
Net Weight	0.3 kg

Center Speaker	
Type	1 Way 1 Speaker
Impedance Rated	3 Ω
Input Power	45 W
Max. Input Power	90 W
Net Dimensions (W x H x D)	115 mm x 115 mm x 84 mm
Net Weight	0.3 kg

Subwoofer	
Type	1 Way 1 Speaker
Impedance Rated	6 Ω
Input Power	75 W
Max. Input Power	150 W
Net Dimensions (W x H x D)	156 mm x 300 mm x 272 mm
Net Weight	2.7 kg

- Design and specifications are subject to change without notice.

Technology with the human touch
GUARANTEE

- LG Electronics U.K. Ltd. will provide the following services in order to expedite this Guarantee.
- 1. All faulty components which fail due to defective manufacture will be replaced free of charge for a period of 12 months from the original date of purchase.
- 2. The dealer (or his service agent) who sold the product will be reimbursed for any labour provided in the repair of this LG equipment, for a period of 12 months from the original date of purchase. These claims must be made in accordance with the published scale of service charges and relevant claims procedure.

PLEASE NOTE:

- A. The dealer may restrict the guarantee to the original purchaser.
- B. The dealer is not obliged to carry out service under guarantee if unauthorized modifications are made to the apparatus, or if non standard components are used or if the serial number of the apparatus is removed, defaced, misused, or altered.
- C. Any claims made under guarantee must be directed to the dealer from whom the equipment was originally purchased. The dealer may, before carrying out service under guarantee, require a receipted account as evidence of the date of purchase.
- D. We respectfully point out that your dealer is not obligated to replace batteries if they become exhausted or worn in use.
- E. Aerial alignment and consumer control adjustments are not covered by this guarantee.

This guarantee does not affect your statutory rights.

- REQUIREMENTS TO MAINTAIN WARRANTY COVERAGE:
RETAIN YOUR RECEIPT TO PROVE DATE OF PURCHASE. A COPY OF YOUR RECEIPT MUST BE SURRENDERED AT THE TIME GUARANTEE SERVICE IS PROVIDED.
- Product Registration Card :
It is helpful to complete at least your name, address, phone, model & serial numbers and return it. This will enable LG to assist you in the future should you lose your receipt, your units be stolen, or should modifications be necessary.
- To obtain information or assistance:
Call UK: 0344 847 5454 IE: 01 686 9454

MODEL NO.*	SERIAL NO.*	DATE OF PURCHASE.*

In all cases of difficulty - consult your LG dealer from whom the product was purchased

LGEUK Website : www.lg.com/uk
(Service website : www.lg.com/uk/support)

