



ENGLISH

FRANÇAIS

ESPAÑOL

# OWNER'S MANUAL CHEST FREEZER

Please read this manual carefully before operating your set and retain it for future reference.

---

# **CONTENTS**

IMPORTANT WARNINGS .....	3-5
INSTALLATION .....	5
POWER SOURCE AND TEST - RUNNING .....	5
FEATURE CHART.....	6
OPERATIONS.....	7
ADVICE ON FOOD STORAGE.....	7
CARE AND CLEANING.....	8
MAINTENANCE.....	8
TROUBLE SHOOTING.....	9
BEFORE CALLING FOR SERVICE .....	10

# IMPORTANT WARNINGS

## WARNING

To reduce the risk of fire, electric shock, or injury to persons when using your product, basic safety precautions should be followed, including the following. Read all instructions before using this appliance.

### **BASIC SAFETY PRECAUTIONS**

This guide contains many important safety messages. Always read and obey all safety messages.

 This is the safety alert symbol. It alerts you to safety messages that inform you of hazards that can kill or hurt you or others or cause damage to the product. All safety messages will be preceded by the safety alert symbol and the hazard signal word DANGER, WARNING, or CAUTION. These words mean:

 **DANGER** You will be killed or seriously injured if you don't follow instructions.

 **WARNING** You can be killed or seriously injured if you don't follow instructions.

 **CAUTION** Indicates an imminently hazardous situation which, if not avoided, may result in minor or moderate injury, or product damage only.

All safety messages will identify the hazard, tell you how to reduce the chance of injury, and tell you what can happen if the instructions are not followed.

### **The dedicated outlet should be used.**

- Using several devices at one outlet may cause fire.
- The electric leakage breaker may damage food and the dispenser may be leaked.

### **Do not pull out the cord or touch the power plug with wet hands.**

- It may cause electric shock or injury.

### **Unplug the power plug when cleaning.**

- It may cause electric shock or injury.

### **Make sure of grounding.**

The incorrect grounding may cause breakdown and electric shock.

### **Do not install the chest freezer in the wet place or the place which water or rain splashes.**

Deterioration of insulation of electric parts may cause electric leakage.

### **When gas is leaked, do not touch the chest freezer or the outlet and ventilate the room immediately.**

### **Do not put bottle in the chest freezer.**

It may freeze the contents to break the bottle to cause injury.

### **Avoid the heating devices.**

It may cause fire.

### **Do not extend or modify the length of the power plug.**

It causes electric shock or fire by the electric damage of the power cord or others.

### **Do not allow the power plug to face upward or to be squeezed at the back of the chest freezer.**

Water may be flown into or the plug may be damaged, which causes fire or electric shock.

### **If the supply cord is damaged, it must be replaced by the manufacturer or its service agent or a similarly qualified person in order to avoid a hazard . Accessibility of supply plug.**

The chest freezer should be so positioned that the supply plug is accessible for quick disconnection when accident happens.

### **Do not damage, puncture, kink, stretch, or twist the power cord.**

A damaged power cord can cause fire or electric shock.

### **Install the chest freezer on the solid and level floor.**

Installing it on the unstable place may cause death by falling down the chest freezer when opening or closing the door.

## **IMPORTANT WARNINGS**

### **Do not store the medicine or the academic materials at the chest freezer.**

When the material with the strict temperature control is stored, it may be deteriorated or it may make an unexpected reaction to cause any risk.

### **Do not insert the hands or the metal stick into the exit of cool air, the cover, the bottom of the chest freezer, the heatproof grill (exhaust hole) at the backside.**

It may cause electric shock or injury.

### **Do not cling to the chest freezer.**

It may make the chest freezer fallen down or damage the hands. Especially, do not allow the children to do the above.

### **Do not spray water at the outside or the inside of the chest freezer or do not clean it with benzene or thinner.**

Deterioration of insulation of electric parts may cause electric shock or fire.

### **Do not allow any person except the qualified engineer to disassemble, repair or alter the chest freezer.**

It may cause injury, electric shock or fire.

**Violating this direction may cause injury or damage house or furniture. Always be careful, please.**

### **Do not touch food or containers at the freezer with wet hands.**

It may cause frostbite.

### **Do not place flower vase, cup, cosmetics, medicine or any container with water on the chest freezer.**

It may cause fire, electric shock or injury by dropping down.

### **Do not use or store inflammable materials ether, benzene, alcohol, medicine, LP gas, spray or cosmetics near or in the chest freezer.**

It may cause explosion or fire.

### **Do not place the lit candle within the chest freezer to deodorize.**

It may cause explosion or fire.

### **When disposing the refrigerator, remove the packing material from the door or take off the doors but leave the shelves in place so that children may not easily climb inside.**

It many cause to lock out the child.

### **Use the submerged chest freezer after checking it.**

It may cause electric shock or fire.

### **Do not put any living animal in the chest freezer.**

### **Do not store explosive substances such as aerosol cans with a flammable propellant in this appliance.**

This appliance is not intended for use by persons (including children) with reduced physical, sensory or mental capabilities, or lack of experience and knowledge, unless they have been given supervision or instruction concerning use of the appliance by a person responsible for their safety.





**Children should be supervised to ensure that they do not play with the appliance.**

If possible, connect the refrigerator to its own individual electrical outlet to prevent it and other appliances or household lights from causing an overload that could cause a power outage.

The refrigerator-freezer should be so positioned that the supply plug is accessible for quick disconnection when accident happens.

If the supply cord is damaged, it must be replaced by the manufacturer or its service agent or a similarly qualified person in order to avoid a hazard.

## IMPORTANT WARNINGS

-  Keep ventilation openings, in the appliance enclosure or in the built-in structure, clear of obstruction.
-  Do not use mechanical devices or other means to accelerate the defrosting process, other than those recommended by the manufacturer.
-  Do not damage the refrigerant circuit.
-  Do not use electrical appliances inside the food storage compartments of the appliance, unless they are of the type recommended by the manufacturer.
-  The refrigerant and insulation blowing gas used in the appliance require special disposal procedures. When disposal, please consult with service agent or a similarly qualified person.



**This appliance contains a small amount of isobutane refrigerant (R600a), natural gas with high environmental compatibility, but it is also combustible. When transporting and installing the appliance, care should be taken to ensure that no parts of the refrigerating circuit are damaged. Refrigerant squirting out of the pipes could ignite or cause an eye injury. If a leak is detected, avoid any naked flames or potential sources of ignition and air the room in which the appliance is standing for several minutes.**

In order to avoid the creation of a flammable gas air mixture if a leak in the refrigerating circuit occurs, the size of the room in which the appliance may be sited depends on the amount of refrigerant used. The room must be 1m<sup>3</sup> in size for every 8g of R600a refrigerant inside the appliance. The amount of refrigerant in your particular appliance is shown on the identification plate inside the appliance. Never start up an appliance showing any signs of damage. If in doubt, consult your dealer.

## INSTALLATION

1. Place your chest freezer at a convenient location.
2. Avoid placing the near any heat sources, direct sunlight or moisture.
3. Clean your chest freezer thoroughly and wipe off all dust accumulated during transportation.
4. Connect the power supply cord to the outlet. Don't plug other appliances to the same outlet.
5. Before use, remove all the packing material. The back side of the cabinet should be more than 20cm away from the wall, both flank sides more than 20cm.
6. The chest freezer should be put in well-ventilated, dry place. Don't use it under direct sunshine. The chest freezer should be kept away from water sink, heat source and any volatile, corrosive material.

## POWER SOURCE AND TEST RUNNING

1. Specified capacity of the wire is 6A. Section squares of the wire is 0.75mm<sup>2</sup>. Single line or compound lines are all allowed. The fuse of 2.5A specified electric current should be installed. (Power cord should be replaced with the same of 6A and 0.75mm<sup>2</sup>, when it is damaged).
2. Single-phase power supply, 60Hz, voltage range 98-147V. If the voltage is unstable, please install a voltage stabilizer with capacity above 1000W.
3. Avoid turning on and off the power too frequently. If the power is turned off, wait an interval of 5 minutes before turning it on again.
4. When the chest freezer will be out of use for along time, disconnect the power first, then clean it. Please examine the circuit whether it is excellent before reuse.

## FEATURE CHART

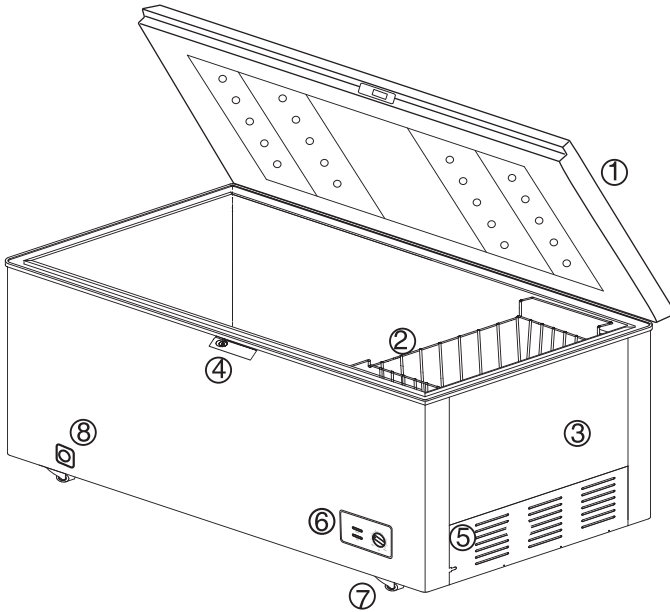

- |                          |                             |
|--------------------------|-----------------------------|
| 1. Door                  | 6. Thermostat control panel |
| 2. Basket (1 or 2)       | 7. Castors                  |
| 3. Cabinet               | 8. Drain cover              |
| 4. Lock (optional)       |                             |
| 5. Compressor room cover |                             |

### NOTE

Parts, features, and options vary by model. Your model may not include every option.

# OPERATIONS

## STARTING

When your chest freezer is first installed, leave it for 2 or 3 hours for stabilization to normal operating temperature before filling it with food.

Delay 5 minutes before restarting if operation has been interrupted.

## TEMPERATURE CONTROL

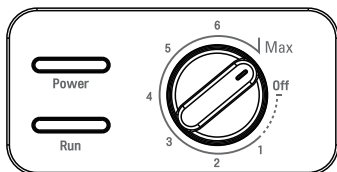

Initially, set the chest freezer control at mid position. If you wish a colder temperature, set the desired compartment control to a higher number.

The knob should be kept upright normally to adjust the temperature.

Power: when the light is on, the power is on.

Run: when the light is on, the compressor is working normally.

"Off" stop the compressor.

"Max" is the strongest cooling position and is suitable for fast freezing. Do not keep the knob at this point for long.

## ADVICE ON FOOD STORAGE

1. Never store hot food in the chest freezer. Always wait until cooled off.
2. When storing, cover food with vinyl wrap or store in a container with lid. When moisture in the food evaporates, taste and nutrition of the food disappear as well.
3. Never place bottles in the freezer compartment. They may break while freezing.
4. Never refreeze food that has been thawed after being frozen. This would cause the taste and nutrition to disappear.
5. Clean food before you store it, so that adjacent food will not be spoiled.
6. There must be space between the foods stored in the cabinet, between the foods and the inner surface of the cabinet, so as to keep good ventilation of cold air and freeze evenly. Do not put in any bottled or canned beverage with freezing point above the temperature in the cabinet when it is below zero.
7. For foods that should be moisture-free or lose water easily, wrap them up with hermetical food bags or fresh films before putting in the cabinet for the sake of avoiding smell-mixing and reducing frosting.
8. Storage of volatile and combustible gases, liquids such as strong alkalis, strong acids, petrol, etc. is forbidden.

## CARE AND CLEANING

### Cleaning-Inside

- To clean the inside, use a soft cloth dampened with solution of one tablespoon of baking soda to a quarter of water, or some mild detergent.
- This solution both cleans and neutralizes odors. Rinse with water and wipe dry. Follow the same procedure to clean the interior parts.

### Cleaning-Outside

- Use a lukewarm solution of mild soap or detergent to clean the durable finish of your chest freezer. Wipe with a clean, dampened cloth, then dry.  
**For products with a stainless steel exterior, use a clean sponge or soft cloth and a mild Detergent in warm water. Do not use abrasive or harsh cleaners.**  
**Dry thoroughly with a Soft cloth. Do not use appliance wax, bleach, or other products containing chlorine on stainless steel.**



#### **WARNING**

Always remove power cord from the wall outlet prior to cleaning in the vicinity of electrical parts. Wipe up excess moisture with a sponge or cloth to prevent water or liquid from getting into any electrical part and causing an electric shock. Do not use flammable or toxic cleaning liquids.

## MAINTENANCE

1. The chest freezer should be cleaned regularly. When cleaning, turn off the power, take out the foods in the cabinet, clean the inside using water or a little neutral detergent.
2. Do not use boiling water, acid, chemical diluents, petrol and oil, or dirt-removing powder.
3. Dry it after cleaning.
4. Use light soap water when cleaning the door seal, apply a little of talcum powder on it after natural drying to extend its service life.
5. Use soft cloth with water or a little detergent to clean the out surface. Note, keeping the power supply and lower part of connect wires away from water to avoid electricity leakage.
6. Except common breakdowns, those who are not service technician should not take apart and repair the chest freezer on their own so as to avoid worsening the trouble. Unauthorized repair of electrical part such as compressor, temperature controller is forbidden.
7. Defrost for better freezing efficiency when the frost film in the cabinet is 4-5mm thick.
8. When defrosting, turn off the power, take out the frozen foods, open the door for warming and melting. Use soft cloth to absorb water and clean it up.
9. Do not use sharp metal tools such as steel brush to clean the frost film when defrosting so as to avoid evaporator damage.
10. **This appliance is intended to be used in household and similar applications such as staff kitchen areas in shops, offices and other working environments; farm houses and by clients in hotels, motels and other residential type environments; bed and breakfast type environments; catering and similar non-retail applications.**



## TROUBLE SHOOTING

Breakdown	Case	Removal method
The indicator is not on. The compressor does not start.	The plug isn't connected to the socket really.	Replug it.
	No power	Connect the socket with power.
The indicator is on, but the compressor doesn't work and buzzes only.	The power voltage is < 98V.	Put a power-regulator more than 1000W power together.
The compressor stops a minute after start, and restart after a few minutes, and so repeatedly.	The power voltage is > 147V.	
The compressor works normally, but the temperature in the cabinet lowers too slowly.	The door is opened too frequently.	Reduce open times.
	The food in the cabinet is too much, and placed improperly.	Place food properly keep place between them for ventilation of cold air.
	The frost film is too thick.	Take out foods and defrost.
	The door seals badly.	Adjust the door seal.
The noise is too loud	The chest freezer is placed unstably.	Place it stably.
	The fixing of the chest freezer is loose.	Tighten the fixing.
	There's contact between pipes.	Separate them.

## **BEFORE CALLING FOR SERVICE**

It is often possible to avoid a service call. Before calling for service, make the following checks.

1. Has a house fuse blown or a circuit breaker tripped on?
2. Has the power cord plug been removed or loosened from the wall outlet?
3. Is the temperature control set to a proper position?
4. Is the appliance placed too close to a wall or a heat source?
5. Has the door been kept open more than necessary?
6. Is the chest freezer installed on a firm and even place?
7. In case of odor, food with strong odor should be tightly covered or wrapped, and interior may need cleaning.

THE FOLLOWING ARE NOT FAULTS:

1. When the chest freezer is working or after it stops for a while, the refrigerant in the pipes is cycling and gives out "running water" sounds.
2. The surface temperature of the compressor may be up to 70°C ~ 80°C when it is working.
3. The front and back side of the chest freezer give off heat.
4. In rainy season, the outer surface of the cabinet may have dew, which makes no difference in normal use. Just dry it with a piece of cloth.