



OWNER'S MANUAL

HOM-BOT

Before using, carefully read the Safety Precautions pages to allow for safe operation of the product. After reading this manual, keep it in an easily accessible location.

VR657*** Ser

VR655*** Ser



MFL67680039

www.lg.com

TABLE OF CONTENTS

BEFORE USING

- 3 Features
- 4 Safety Precautions
- 9 Included with Product
- 10 Parts
- 12 Button Functions
- 14 Display Status
- 15 Before Starting
- 16 Overview

METHOD OF USE

- 17 Installing the Home Station
- 18 Turning the Robot Cleaner On/Off
- 19 How to Start and Stop Cleaning
- 20 Charging the Battery
- 23 Choosing a Cleaning Mode
- 25 Auxiliary Cleaning Modes
- 27 Setting the Clock
- 28 Scheduling Cleaning
- 29 Mop Cleaning (on some models)
- 30 Location Search Function
- 31 Smart Diagnosis™

MAINTENANCE

- 33 Cleaning the Dust Bin
- 34 Cleaning the Dust Bin Filter
- 35 Cleaning the Brush
- 36 Cleaning the Sensor/Charging Terminal
- 37 Cleaning the Side Brush
- 38 Cleaning the Ultra Microfiber Mop
(on some models)

ADDITIONAL INFORMATION

- 39 Troubleshooting
- 42 Before Calling for Service

REFERENCE

- 43 Product Specifications
- 44 Reference Items
- 45 Performance Testing (IEC 62929 Standard)

WARRANTY

- 46 LG Robot Cleaner WARRANTY

FEATURES

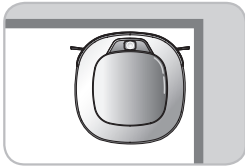

Corner Master

The Robot Cleaner's ability to navigate around walls is part of what makes its cleaning performance so efficient.

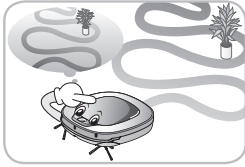

Learning Mode

The Robot Cleaner memorizes the cleaning environment for smarter cleaning via its Smart Operation feature.

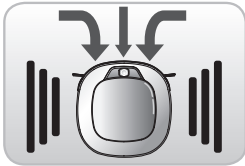

Turbo Mode

In the Turbo mode, the Robot Cleaner operates the suction motor and the brushes at a greater speed giving cleaner results. When selected, the Turbo mode activates automatically, cleaning carpets more efficiently.

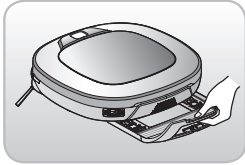

Drawer Mop Plate (on some models)

Use the optional drawer mop plate to fit and remove the mop without having to turn the Robot Cleaner over.



My Space Mode

The Robot Cleaner can be programmed to quickly clean a desired space.

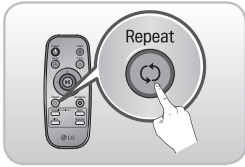

Repeat Cleaning

The Robot Cleaner cleans continuously until the battery runs out.

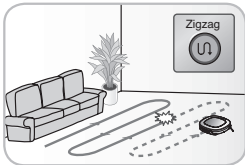

Location Search Function

If the Robot Cleaner is moved from a spot while operating, the device will automatically search for the previous location and return to the spot where it was interrupted.

SAFETY PRECAUTIONS

This guide contains many important safety messages. Always read and obey all safety messages. Read all instructions before using.

SAVE THESE INSTRUCTIONS

Basic Safety Precautions

After reading this manual, please keep it in an easily accessible location.



This is the safety alert symbol. This symbol alerts you to potential hazards that can result in property damage and/or serious bodily harm or death.



WARNING

Indicates a hazardous situation which, if not avoided, could result in death or serious injury.



CAUTION

Indicates a hazardous situation which, if not avoided, could result in minor or moderate injury.

IMPORTANT SAFETY INSTRUCTIONS



WARNING

1. This appliance is not intended for use by persons (including children) with reduced physical, sensory or mental capabilities, or lack of experience and knowledge, unless they have been given supervision or instruction concerning use of the appliance by a person responsible for their safety.
2. Children should be supervised to ensure that they do not play with the appliance.
3. If the supply cord is damaged, it must be replaced by an LG Electronics Service Agent in order to avoid a potential hazard.
4. This appliance can be used by children aged 8 years and above and persons with reduced physical, sensory or mental capabilities or lack of experience and knowledge if they have been given supervision or instruction concerning use of the appliance in a safe way and understand the hazards involved. Children shall not play with the appliance. Cleaning and user maintenance must not be performed by children without supervision.

SAFETY PRECAUTIONS



WARNING

- 1) Place the cords from other appliances out of the area to be cleaned.
- 2) Do not operate the vacuum in a room where an infant or child is sleeping.
- 3) Do not operate the vacuum in an area where there are lit candles or fragile objects on the floor to be cleaned.
- 4) Do not operate the vacuum in a room that has lit candles on furniture that the vacuum may accidentally hit or bump into.
- 5) Do not allow children to sit on the vacuum.
- 6) Do not use the vacuum on a wet surface.

- **For your safety, do not remove the battery from the Robot Cleaner. If you need to replace the battery of the Robot Cleaner, take it to the nearest authorized LG Electronics service center or dealer for assistance.**

Failure to follow this warning can cause fire or product failure.

- **Make sure the power cord of the home station is not crushed under a heavy object or damaged by contact with sharp objects. If the power cord is broken, do not plug it in. Take the product to an LG Electronics authorised service repairer.**

Failure to follow this warning can cause electric shock, fire or product failure.

- **Do not place the home station and/or the Robot Cleaner near a heating device.**
Doing so can cause product deformation, fire, or product failure.

- **Do not force the power plug to bend. Do not use the power plug when it has been damaged or loosened.**

Doing so can cause fire or product failure.

- **Do not touch the power plug with wet hands.**

Doing so can cause electric shock.

- **Have servicing performed by an authorized service repairer using only identical replacement parts. This will ensure that the safety of the product is maintained.**

- **Never use the Robot Cleaner with a battery and/or home station from any other product than the Robot Cleaner.**

Doing so can cause fire or product failure.

- **Do not use the Robot Cleaner when candles or fragile objects are placed on the floor.**

Doing so can cause fire or product failure.

- **Always use a dedicated power outlet with a 10 amp rating.**

If multiple appliances are connected to an outlet simultaneously, they can generate enough heat to cause a fire.

- **When pulling out the home station power plug, always pull it out by grabbing the plug, not the cord. When pulling out the power plug, do not touch the prongs with your fingers.**

Doing so can cause an electric shock.

SAFETY PRECAUTIONS



WARNING

- **Do not allow children or pets to play with or rest upon the Robot Cleaner at any time. Do not use the Robot Cleaner while an object is hanging from it.**

Doing so can cause injury or product damage.

- **Keep gasoline, thinners, or other flammable materials, detergents, shampoos, or other foaming agents, or drinking water away from the Robot Cleaner.**

Failure to do so can cause fire or product failure.

- **Do not insert any part of the body, such as a hand or foot, below the brush or wheels of the Robot Cleaner while in use.**

Doing so can cause injury or product damage.

- **Do not operate the Robot Cleaner on narrow and high furniture such as a wardrobe, refrigerator, desk, table, etc.**

Doing so can cause injury, product failure or damage which is not covered by the warranty.

- **Do not activate the device on a floor that has more than a 10 degree incline.**

The device may not work properly.

- **Turn the power supply off immediately if any abnormal sound, odor or smoke is generated from the Robot Cleaner. Remove the Robot Cleaner from the home station and turn off the main switch on the rear side of the unit.**

Failure to do so can cause fire or product failure.

- **Do not operate the Robot Cleaner in a room where a child is sleeping.**

Doing so can cause injury or product damage.

- **Do not leave children or pets near the Robot Cleaner unsupervised.**

Doing so can cause injury or product damage.

- **Do not repair or replace any parts or attempt any servicing other than as described in this manual. We strongly recommend that any service be performed by a qualified technician.**

- **A coin cell battery on the mainboard of the Robot Cleaner cannot be replaced by the user. Used cells must be disposed of properly.**

- ⚠ **This product is intended for indoor, domestic use and should not be used in mobile or commercial locations, such as workshops, garages, indoor swimming pools, etc.**

- **This product contains chemicals known to the State of California to cause cancer and birth defects or reproductive harm. *WASH HANDS AFTER HANDLING.***

SAFETY PRECAUTIONS



CAUTION

- **Frequently empty the dust bin and keep it clean.**

The dust collected in the dust bin can trigger allergies and may contain harmful insects. It should be cleaned after each use.

- **Only use the Robot Cleaner indoors.**
Using it outdoors can cause product failure and irreparable damage to the unit.

- **Close the cover of the dust bin on the main unit before use.**

If the cover is not closed, it can cause injury or product damage.

- **DO NOT use the Robot Cleaner around a banister, staircase or any other dangerous place.**

Doing so could cause injury or damage to the unit.

- **In rare cases, the Robot Cleaner's brush can damage carpet. If this happens, immediately stop the cleaning operation.**

When a carpet has long tassels, the tassels can be damaged.

- **Do not let the main unit and charging terminal of the home station come into contact with metallic objects.**

Doing so can cause product failure.

- **Do not put water, detergent, etc. into or onto the Robot Cleaner.**

Doing so can cause product failure. If liquids get inside of the Robot Cleaner, turn off the power supply and contact an LG Electronics sales agent or customer care center.

- **Do not drop the Robot Cleaner or subject it to strong impacts.**

Doing so can cause injury or product failure not covered by the warranty.

- **Do not expose the Robot Cleaner to temperatures lower than 23°F (-5°C) for a long period of time.**

Doing so can cause product failure.

- **Remove any cables or string from the floor before use.**

Cable or string can get tangled in the wheels of the Robot Cleaner and cause product failure or cause another appliance to be disconnected.

- **Do not place the Robot Cleaner on a table or other elevated surface while it is on.**

Doing so may result in an injury or damage to the product.

- **Do not allow the Robot Cleaner to sweep up liquids, blades, thumb tacks, sharp objects or ashes, hot or cold. etc.**

These items can cause product failure or damage.

- **Do not put sharp objects into the opening of the Robot Cleaner's ultrasonic sensors.**

Doing so can cause product failure.

- **Do not use the Robot Cleaner when the dust bin is completely full.**

Doing so can cause product failure.

- **If the floor is wet or has wet spots, wipe them up before using the Robot Cleaner. Do not use the Robot Cleaner on a wet surface.**

Doing so can cause product failure.

- **Attach the mop so that it does not block the lower camera sensor.**

Blocking the bottom camera sensor may prevent the product from working correctly.

- **Turn off the power switch to save energy when the Robot Cleaner is not in use for long periods. Turn on the power switch just prior to resuming use.**

- **Prevent unintentional starting. Ensure the switch is in the off-position before connecting to the battery pack, picking up or carrying the appliance. Carrying the appliance with your finger on the switch or energizing an appliance that has the switch on invites accidents.**

SAFETY PRECAUTIONS



CAUTION

- **Disconnect the battery pack from the appliance before making any adjustments, changing accessories, or storing the appliance. Such preventive safety measures reduce the risk of starting the appliance accidentally.**
- **When the robot cleaner is operating, it may hit a chair leg, desk leg, table leg or other narrow pieces of furniture.**
For quicker and better cleaning, place dining chairs on top of the dining table.
- **Recharge only with the charger specified by Robot Cleaner provided by LG Electronics. A charger that is suitable for one type of battery pack may create a risk of fire when used with another battery pack.**
- **Use appliances only with specifically designed battery packs for Robot Cleaner provided by LG Electronics. Use of any other battery packs may create a risk of injury and fire.**
(* Discharging Range : -20~60°C
Charging Range : 0~60°C)
- **When battery pack is not in use, keep it away from other metal objects, like paper clips, coins, keys, nails, screws or other small metal objects, that can make a connection from one terminal to another. Shorting the battery terminals together may cause burns or a fire.**
- **Under abusive conditions, liquid may be ejected from the battery; avoid contact. If contact accidentally occurs, flush with water. If liquid contacts eyes, seek medical help.**
Liquid ejected from the battery may cause irritation or burns.
- **Do not use a battery pack or appliance that is damaged or modified. Damaged or modified batteries may exhibit unpredictable behavior resulting in fire, explosion or risk of injury.**
- **Do not expose a battery pack or appliance to fire or excessive temperature. Exposure to fire or temperature above 265°F (130°C) may cause explosion.**
- **NOTE: Very low thresholds will allow the Robot cleaner to go over them and perhaps into an undesirable location. Make sure that all doors to rooms that are not to be cleaned are closed.**



Tip

Check the following items before use:

- Empty the dust bin after each operation or prior to it filling up.
- Remove any cables or long strings from the floor.
- Remove any moisture from the floor before cleaning.
- Close the cover of the dust bin before cleaning.
- Remove fragile or unnecessary objects from the room to be cleaned.
For example, remove expensive ceramics and valuables from the floor.
- Make sure the battery is charged.
- Close the doors of any room that you do not want the Robot Cleaner to enter.
During cleaning, the Robot Cleaner may enter another room and continue cleaning.
- Do not use this product in the room where a child is sleeping alone. The child can be hurt or woken.
- Remove towels, floor mats, or any other thin cloth from the floor as they can get caught by the brush.
- Before starting the device, remove carpets that are thicker than 3/4 in. (20 mm) as they may cause it to malfunction.
- Please close any balcony doors as the wheels may get stuck while cleaning.

INCLUDED WITH PRODUCT



Robot Cleaner



Remote controller

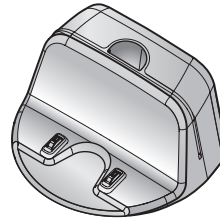

Home station

► Appearance and accessories may vary depending on model.

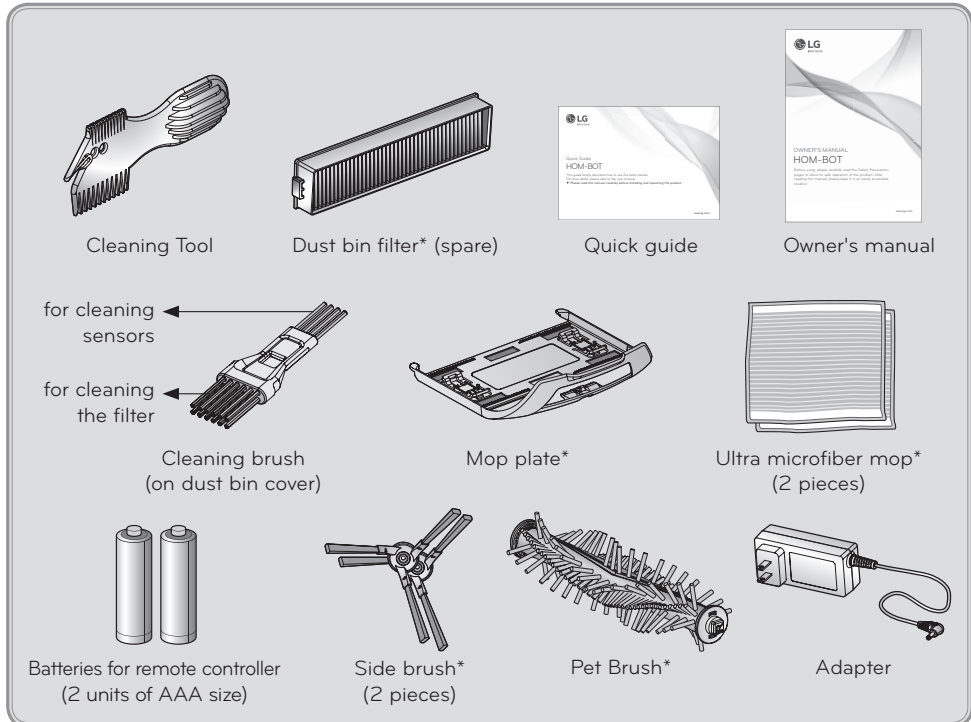

*Available on some models.

PARTS - ROBOT CLEANER

Top view

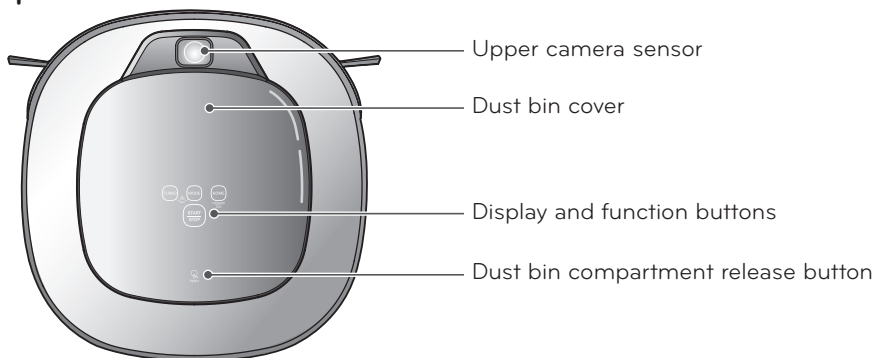

Front view

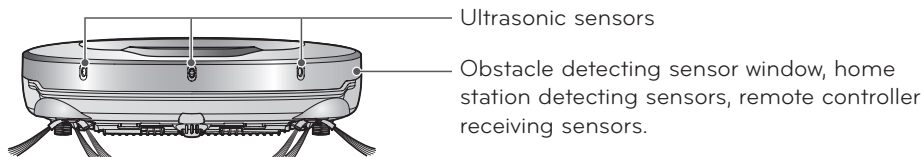

Rear view

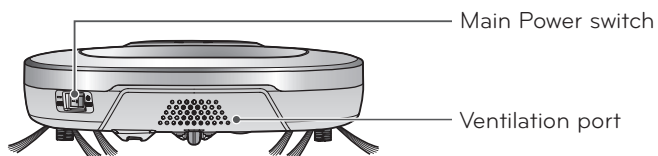

Bottom view

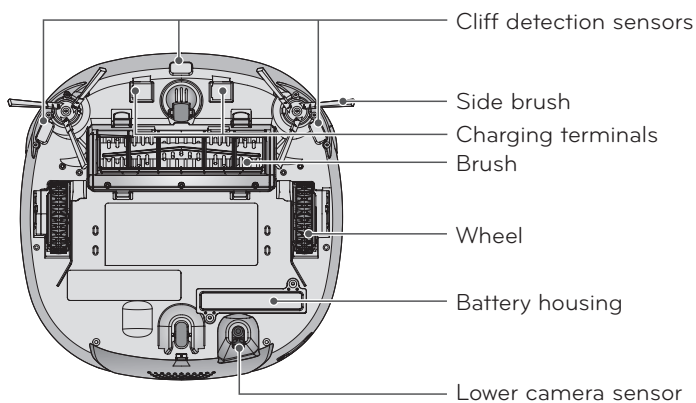

► Appearance may vary depending on model.

PARTS – HOME STATION / DUST BIN

Home station

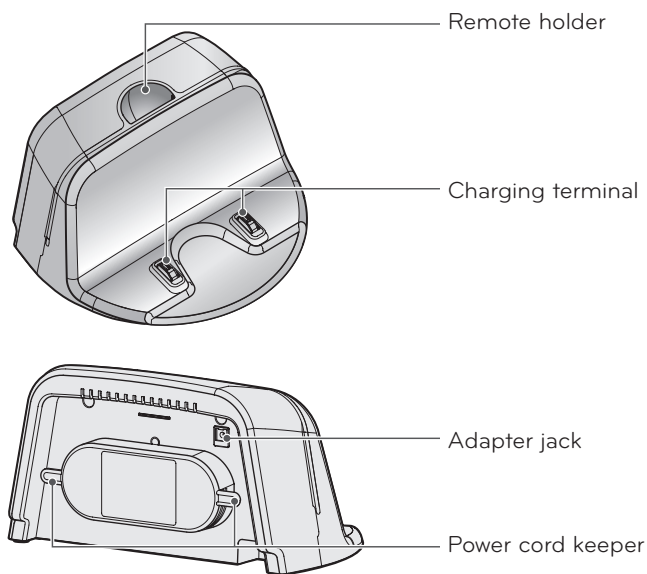

Dust bin

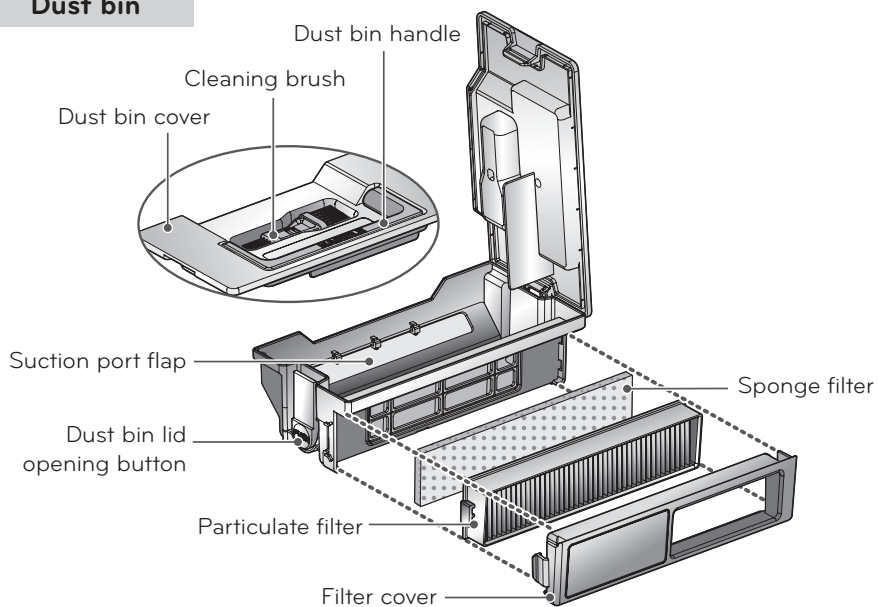

► Appearance may vary depending on model.

BUTTON FUNCTIONS – ROBOT CLEANER

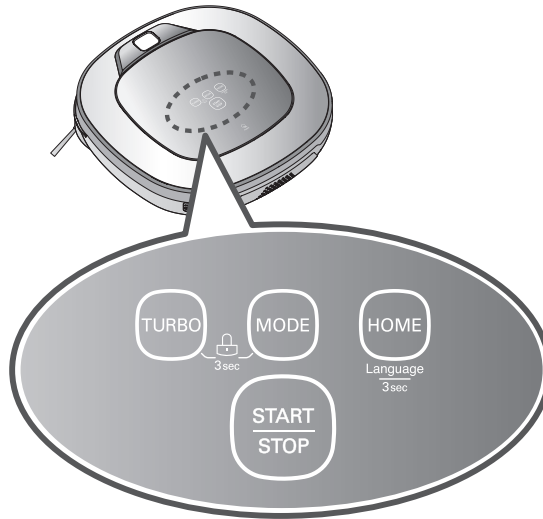

TURBO	<ul style="list-style-type: none"> • Press to activate Turbo Mode. • Press again (while in Turbo Mode) to deactivate Turbo Mode.
START/STOP	<ul style="list-style-type: none"> • After the power switch is in the ON position, press the Start/Stop button to start cleaning. • Press to stop cleaning. • Press and hold for two seconds to return to standby mode. • If button is pressed during Smart Diagnosis, the diagnosis will end.
MODE	<ul style="list-style-type: none"> • Press to change the mode. The mode icon will illuminate on the display when selected. • The Spot Clean mode is not available if the Robot Cleaner is at the home station. • The My Space mode can only be selected by remote control (when the Robot Cleaner is not on the home station).
HOME	<ul style="list-style-type: none"> • Press to return the Robot Cleaner back to the home station for charging or storage. • If cleaning is finished or the battery is low, the Robot Cleaner will automatically return to the home station to recharge the battery.
BUTTON LOCK On/Off	<ul style="list-style-type: none"> • Press and hold the Turbo and Mode buttons simultaneously for three seconds to activate or deactivate the Button Lock function. • If the Button Lock function is activated, "Key lock has already been set" voice notification will play every time a button is pressed.
Language Change	<ul style="list-style-type: none"> • Press the Home button for three seconds to change the language for the voice message. • This function cannot be set using the remote.

BUTTON FUNCTIONS – REMOTE

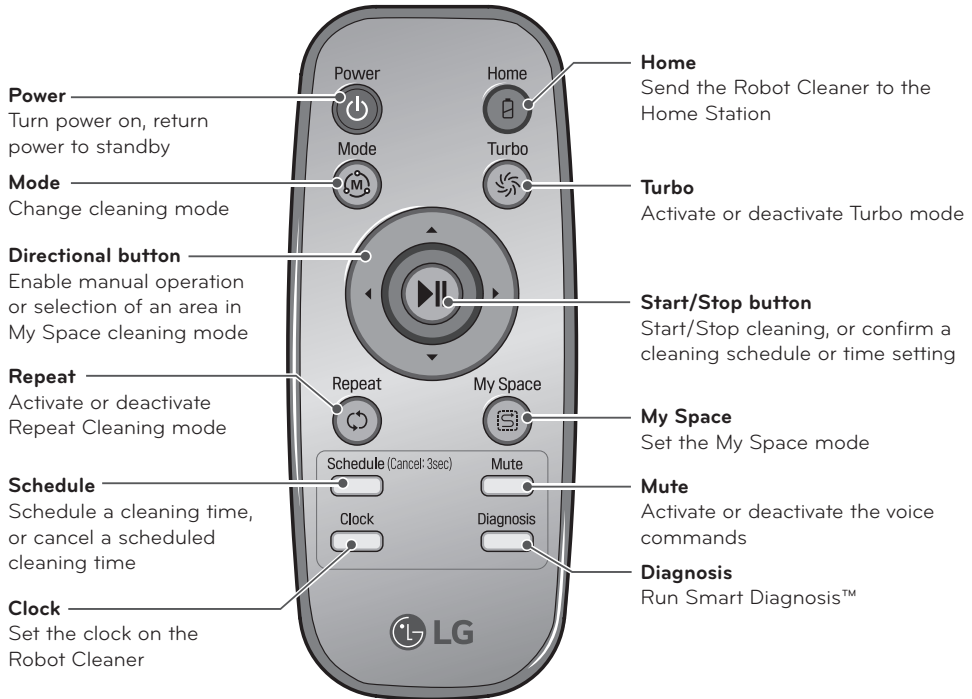

Tip

- To turn the power ON/OFF, use the START/STOP button on the upper section of the Robot Cleaner or the Power button on the remote.
- The Mode, My Space and Clock buttons can only be set while the Robot Cleaner is not cleaning.
- To cancel a scheduled cleaning, press and hold the Schedule button for three seconds while the Robot Cleaner is recharging.

DISPLAY STATUS

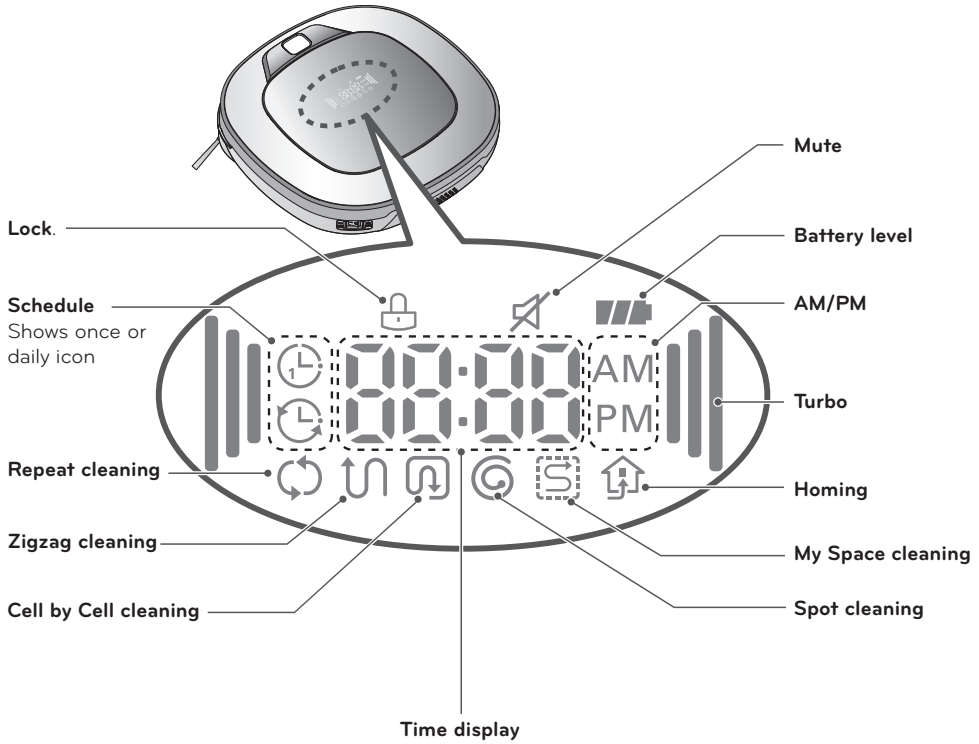

 **Tip** • The Robot Cleaner defaults to the last cleaning mode selected.

BEFORE STARTING

Before Cleaning

- Do not use this device in a room where a child is left alone. The child could be injured.
- Remove fragile or unnecessary objects from the room to be cleaned, especially expensive ceramics and valuables which could fall or break.
- Close the cover of the dust bin compartment before cleaning.
- Remove any moisture that might be on the floor.
- Remove cables, strips, towels, mats etc. from the floor so they will not get tangled in the brushes.
- Make sure the battery is charged.
- Empty the dust bin before or after each use, or before it becomes full.
- Close the doors of any room that you do not want the Robot Cleaner to enter. During cleaning, the Robot Cleaner may enter another room and continue cleaning.
- When the mop is attached, Robot Cleaner will not be able to go over thresholds higher than 3/16 in. (5 mm). If you are not planning to use the mop for cleaning, remove the mop before using Robot Cleaner.
- Before starting the device, remove carpets that are thicker than 3/4 in. (20 mm) as they may cause it to malfunction.
- Close any balcony doors as the wheels may get stuck while cleaning.

Loading the Remote's Batteries

1. Open the battery cover by lifting the rear hook of the remote.
2. Insert two AAA batteries, checking for +, - nodes while loading.
3. Close the battery cover completely so that the batteries will not fall out.

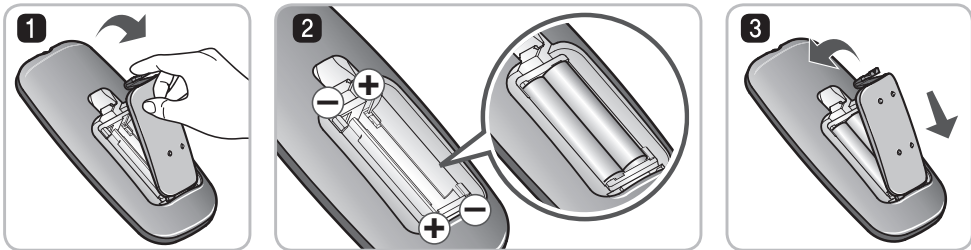

Precautions while Using the Remote

- Only press one button at a time.
- Do not drop or subject the remote to any impact.
- Do not store the remote near devices that give off heat, fire or hot air.
- Certain fluorescent lamps, such as three band radiation lamps, can interfere with the activation of the remote. Therefore, use it as far away as possible from such lamps.
- If the remote is far from the Robot Cleaner when activated, it may fail to operate properly. Use the remote within 9.8 ft (3 m) of the Robot Cleaner if possible.

OVERVIEW

1

Install the home station. (p17)

Insert the power cord plug into an outlet and locate the station against a wall. If power is not supplied to the home station, the Robot Cleaner will not charge.

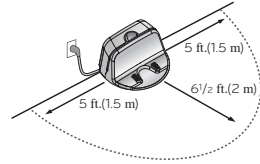

2

Turn on the power supply of the Robot Cleaner. (p18)

Turn on the power switch located on the rear-left side of the Robot Cleaner. Press the Start/Stop button on the Robot Cleaner or the Start button on the remote.

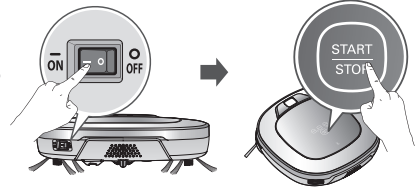

3

Check the dust bin.

Empty the dust bin if necessary.

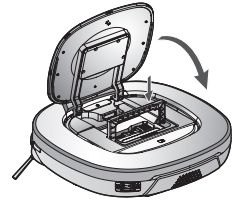

4

Select the desired cleaning mode and options. (p23-29)

Set the cleaning mode and options using the buttons on the Robot Cleaner or on the remote.

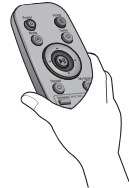

5

Start cleaning. (p19)

Press the Start/Stop button on the Robot Cleaner or the Start button on the remote. Cleaning begins once the Robot Cleaner reverses and turns around.

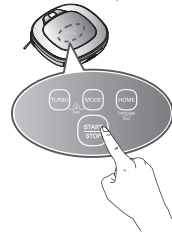

6

Automatic charge. (p20-22)

The Robot Cleaner automatically returns to the home station to charge. If the Robot Cleaner is in the middle of cleaning and runs out of battery charge, it returns to the home station to recharge and then continues cleaning where it left off once the battery is fully charged.

It takes approximately three hours for the battery to fully charge.

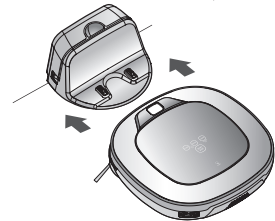

Warning If the Robot Cleaner is operated with the dust bin compartment lid left open, it can cause an injury or serious damage to the product.

INSTALLING THE HOME STATION

1. Position the home station against a wall on hard, level flooring to prevent sliding during docking.

It is not recommended to install the home station on carpet. Doing so may cause the Robot Cleaner to have difficulty docking.

Remove objects within 5 ft. (1.5 m) to the right and left side and within 6 1/2 ft. (2 m) to the front.

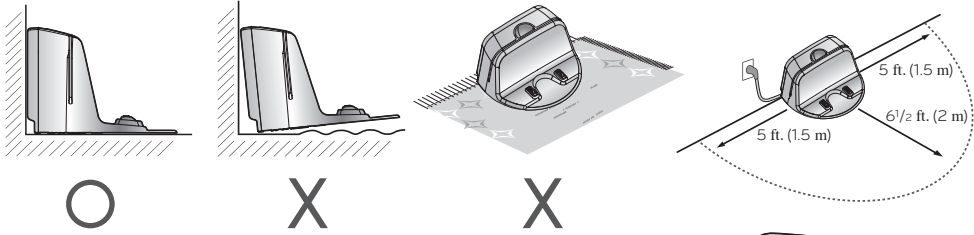

2. Plug the jack into the home station.

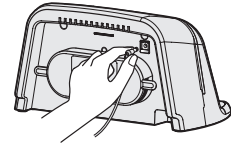

3. Plug the power cord into an outlet.

Wrap the remaining power cord around the cord keeper on the back side of the home station or along the wall surface so that the travel path of the Robot Cleaner will not be obstructed.

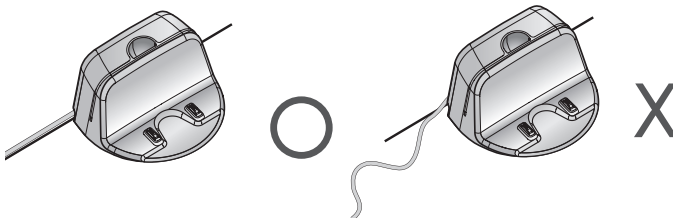
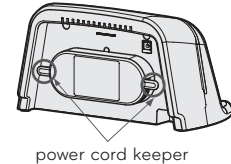

4. Fix the home station against the wall so that it does not move.

5. When the remote is not in use, store it in the remote holder on the home station.

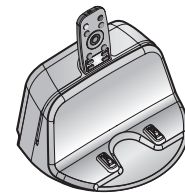

Tip • Always keep the home station plugged in when in use. If the home station is not plugged in, the Robot Cleaner will not return to the station to charge automatically.

Warning Do not operate the Robot Cleaner if the home station has a damaged cord or plug, if it is not working properly, or if it has been damaged or dropped. To avoid electrical hazards, the cord must be replaced by LG Electronics, Inc. or a qualified service person.

TURNING THE Robot Cleaner ON/OFF

Turning On the Main Power Supply

Flip the power switch to the ON position.

- * Do not press the Start/Stop button at the same time as flipping the power switch. Doing so may delay the operation.
- * Turn off the power switch when the Robot Cleaner is not used for long periods. The switch must be turned back on for the Robot Cleaner to charge.

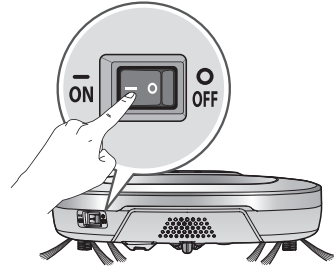

Turning On from Standby Mode

If the Robot Cleaner is in standby mode, press and hold the Start/Stop button for one second or until a tone sounds. After approximately 10 seconds a melody sounds and the Robot Cleaner comes out of standby mode.

- * If the Robot Cleaner is not used within 10 minutes of being turned on, it returns to standby mode.

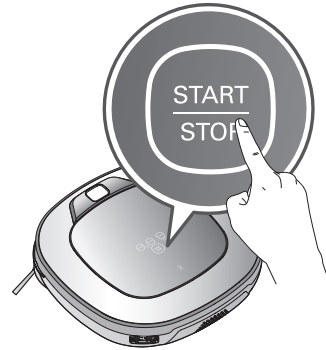

Turning Off the Power Supply

Press the Power button on the remote or press and hold the Start/Stop button on the Robot Cleaner for two seconds to turn off the Robot Cleaner. A melody sounds when the Robot Cleaner is turned off.



Tip

- If the power cannot be turned on, do the following.
 1. Turn the main power switch OFF, wait 5 seconds, then turn it ON again.
 2. Press the START/STOP button on the Robot Cleaner or the Power button on the remote.
 3. If the Robot Cleaner still does not power on or if there is nothing in the display, mount the Robot Cleaner on the home station and let it charge.

HOW TO START AND STOP CLEANING

Using the Robot Cleaner's Buttons

Once the Robot Cleaner is turned on, press the START/STOP button on the top of the Robot Cleaner to begin cleaning. A melody sounds and cleaning begins.

Press the START/STOP button any time during the cleaning cycle to stop cleaning.

※ To start cleaning when the Robot Cleaner is in standby mode, press START/STOP once to turn on the power, then press again to start cleaning.



Using the Remote

Press the Power button on the remote to turn on the Robot Cleaner.

Once the Robot Cleaner is turned on, press the Start/Stop button on the remote to start cleaning. A melody sounds and cleaning begins.

Press the Start/Stop button any time during the cleaning cycle to stop cleaning.



※ Collisions can occur during cleaning when the sensor cannot detect objects such as thin chair legs, table legs, or furniture corners. The internal impact detecting sensor reacts by moving the Robot Cleaner backwards.

※ If the Robot Cleaner is set to start cleaning at a location away from the home station, select a flat floor clear of obstacles for a starting location to prevent a malfunction of the obstacle detecting sensor. Curtains and walls must be 12 in. (30 cm) from the Robot Cleaner.

Tip For best results:

- Briefly scan the area to be cleaned for big and small objects that will cause difficulty for the Robot Cleaner.
- If cleaning is started when the Robot Cleaner is at the home station, the device can rapidly be returned to the home station as the current home position has been accurately read.
- When the mop plate is installed, the Robot Cleaner will not go over door sills or other obstructions higher than 3/16 in. (5 mm).

CHARGING THE BATTERY

Automatic charging

The Robot Cleaner returns to the home station at the end of a cleaning cycle or when its battery is running low.

- ※ If 10 minutes elapse without the Robot Cleaner moving or the battery is too low, the Robot Cleaner automatically goes into standby mode.
- ※ **The power switch has to be in the ON position in order for the Robot Cleaner to charge at the home station. If the switch is OFF, an error message sounds.**
- ※ After the battery is fully charged, the Robot Cleaner resumes cleaning, if interrupted, from the spot where it left off. (Page 21)
- ※ If the Robot Cleaner is unable to dock to the home station on its first attempt, it will try again until it docks successfully.
- ※ When the Robot Cleaner has completed cleaning the area, it will return to the home station even if the battery level is not low.

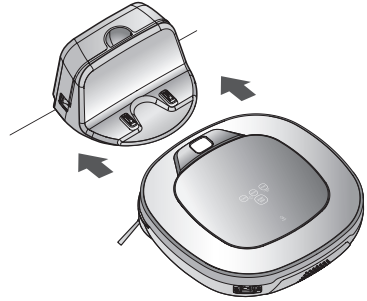

Manual charging

Manually charge the Robot Cleaner before using it for the first time.

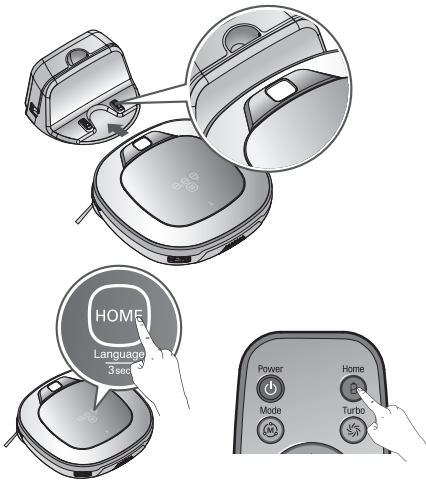

Method 1. Attach the Robot Cleaner to the home station by aligning it to the front side of the home station. A melody sounds along with a message to start charging.

- ※ The main power switch must be in the ON position in order for the Robot Cleaner to charge. An error message is heard if the power switch is in the OFF position while mounted to the home station.

Method 2. Press the HOME button on either the Robot Cleaner or the remote to return the Robot Cleaner to the home station to charge.

- ※ If the Robot Cleaner did not start cleaning from the home station or if the Robot Cleaner is manually charged by pressing the Home button, it may take slightly longer to find the home station.
- ※ If the Robot Cleaner is within 4 in. (10 cm) of the front of the charging terminal while the power is turned on from Standby, it will automatically be returned to the home station and charging will begin.

Tip Take the following precautions when using the home station:

- If foreign material is caught on the charging terminal, charging may not be activated. Wipe the terminal from time to time with a dry cloth after the power plug is disconnected.(p36)
- To prevent electric shock or damage to the home station, do not touch the charging terminal with any metallic objects.
- To avoid fire or electric shock, never disassemble or modify the home station.
- Do not to place the Robot Cleaner, the home station or the power plug near a heat source.

CHARGING THE BATTERY

Battery Level Indicator

The battery level indicator is located on the status display.

- The battery level indicator flashes if recharging is in progress, showing the charge level.
- If recharging is complete, only the battery and clean mode icons are displayed to save energy.
- The first level of the battery level icon flashes when the Robot Cleaner needs to be charged.



※ If the Robot Cleaner performs an automatic recharge while in a cleaning cycle, the cleaning mode icon flashes while the Robot Cleaner is mounted on the home station.

- After an automatic recharge, the Robot Cleaner continues cleaning in the areas that were not completed.
- Pressing the Start button on the remote or the Start/Stop button on the Robot Cleaner while the Clean Mode light is flashing will direct the Robot Cleaner to clean uncovered areas.
- Press the Start button on the remote or the Start/Stop button on the Robot Cleaner after charging is complete to start cleaning from the beginning.

The status indicators show the different pending conditions during charging mode.



When no area remains to be cleaned after charging.



When an area remains that the Robot Cleaner will resume cleaning after charging. (flashing Cleaning indicator)

CHARGING THE BATTERY

Energy Saving Charging Mode

You can recharge the battery with the Energy Saving mode, if you don't use the Robot Cleaner for a long period of time or overnight.



Step 1. Press the On/Off button on the remote. All functions of the Robot Cleaner are turned off except the recharging mode.

※ After recharging is complete, press the On/Off button on the remote to use the Robot Cleaner.

If the Battery is Not Charging

Check 1:

If the Robot Cleaner is not charging while attached to the home station, try the following.

- Turn the power switch on the rear-left of the Robot Cleaner off once and then on again.
- Check the power lamp to make sure the home station is turned on.
- Wipe the terminals on the home station with a dry cloth. (p36)

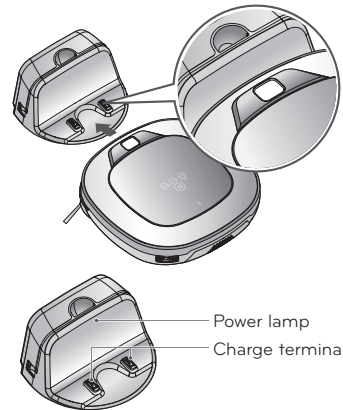

CHOOSING A CLEANING MODE

Zigzag Cleaning

In Zigzag mode, the Robot Cleaner zigzags through each spot of the cleaning area. Select the Zigzag mode to quickly clean an area.

Selecting the Zigzag Mode

Press the Mode button continuously, on either the Robot Cleaner or remote, until the Zigzag icon illuminates.

* The default mode on the Robot Cleaner is the Zigzag mode.

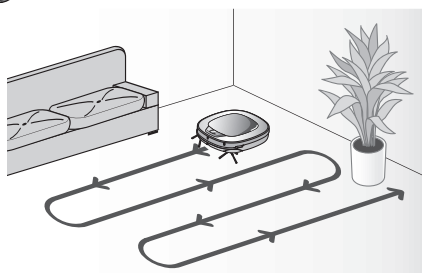
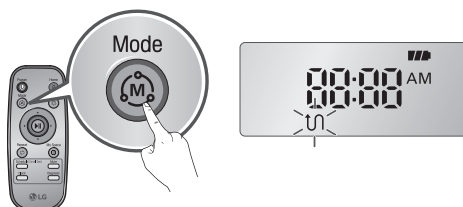

Cell by Cell Cleaning

Select the Cell by Cell mode for meticulous cleaning. In this mode, the Robot Cleaner divides the area to be cleaned into rectangular spaces.

Selecting the Cell by Cell Mode

Press the Mode button continuously, on either the Robot Cleaner or remote, until the Cell by Cell icon illuminates.

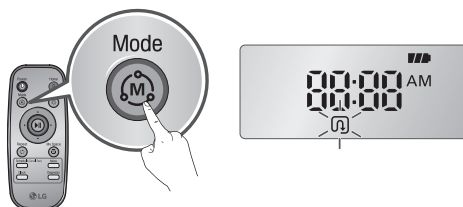

Stage One

First, the outline of each space is cleaned. The size of the outline may vary with the shape of the overall area to be cleaned, but the maximum size of each space is approximately 10 ft. x 10 ft. (3 m x 3 m).

Stage Two

Second, the interior of each space is cleaned in the Zigzag mode.

These stages repeat until the entire area is clean.

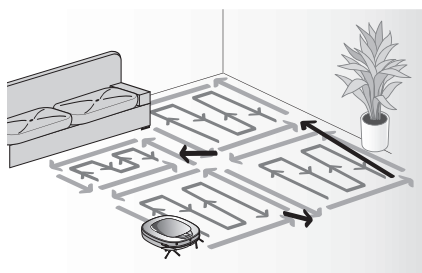

Tip

- The Robot Cleaner defaults to the last cleaning mode used when it is turned back on after being powered off.
- To change the cleaning mode during operation, press the Start/Pause button on the remote and select a new cleaning mode. Cleaning starts from the beginning.

CHOOSING A CLEANING MODE

My Space Cleaning

Select the My Space mode to manually set the cleaning space.

Selecting the My Space Mode

1. Press the My Space button.
2. Using the arrow buttons on the remote, guide the Robot Cleaner around the perimeter of the desired cleaning space.

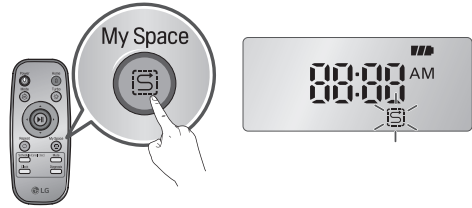

* Cleaning space must be smaller than 3 1/4 ft. (3 m).

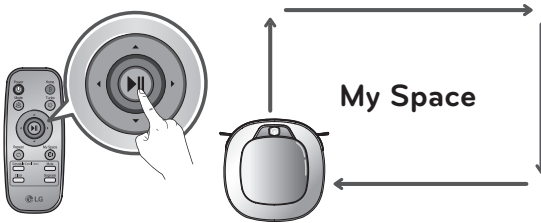

3. Once the area is specified, press the Start button.

NOTE: If the cleaning area is not correctly outlined, an error message sounds. Repeat steps 1 and 2 until the cleaning area has been correctly specified.

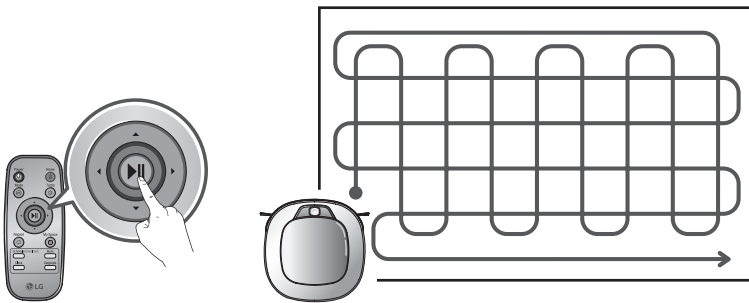

- Tip**
- The My Space cleaning mode cannot be activated while the Robot Cleaner is charging
 - To change the cleaning mode during operation, press the Stop button and select a different mode. The cleaning cycle will then start over.

AUXILIARY CLEANING MODES

Manual Cleaning

Manual mode moves the Robot Cleaner manually to the front, back and either side using the arrow buttons on the remote.

While in Manual mode, the Robot Cleaner runs into obstacles placed behind it if the back arrow key on the remote is held down.

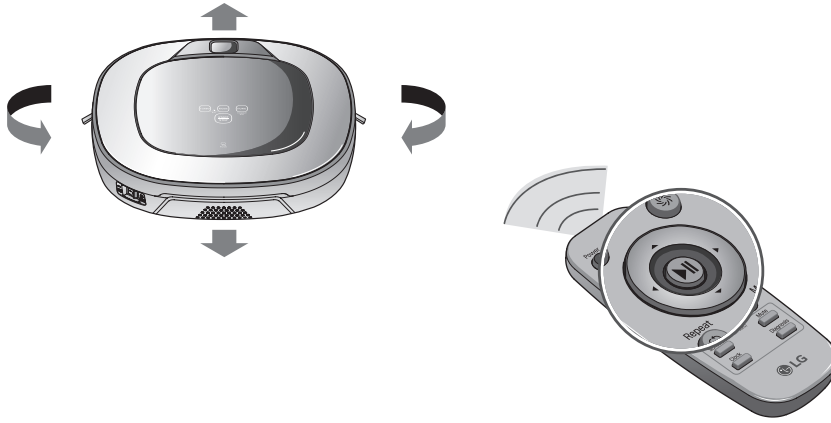

Spot Cleaning

The Spot mode cleans the area where it is placed within a 4¹/₂ ft (1.37 m) diameter.

Starting Spot Mode

1. Place the Robot Cleaner in the desired cleaning area.
2. Press the Mode button continuously until the Spot mode icon displays in the screen.
3. Press the Start button.

* The Spot mode cannot be selected while the Robot Cleaner is recharging.



AUXILIARY CLEANING MODES

Turbo Mode

Select Turbo Mode for a more intense, powerful clean. Turbo Mode reduces the battery duration.

Selecting Turbo Mode

Press the Turbo button on the remote or on the Robot Cleaner to activate the Turbo mode.

Press the Turbo button at any time during the cleaning operation to cancel the Turbo mode.

* Turbo Mode (Floor Master Function)

Turbo mode activates automatically on carpets.

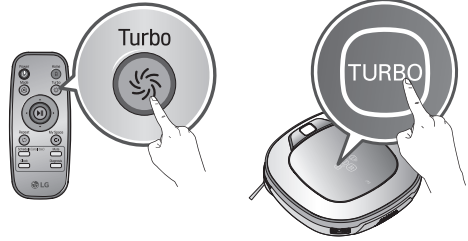

Repeat Mode

Select the Repeat mode to repeat the cleaning in progress until the battery runs out, without returning to the home station.

Selecting the Repeat Mode

Press the Repeat button on the remote or on the Robot Cleaner to activate the Repeat mode.

Press the Repeat button at any time during the cleaning operation to cancel the Repeat mode.

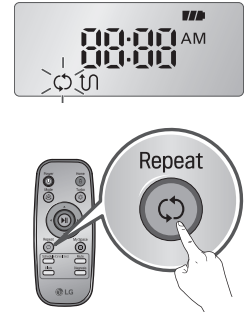

Learning Mode

The Robot Cleaner memorizes the cleaning environment through the Learning mode.

* The Learning mode is only available when the Robot Cleaner starts cleaning from the home station.

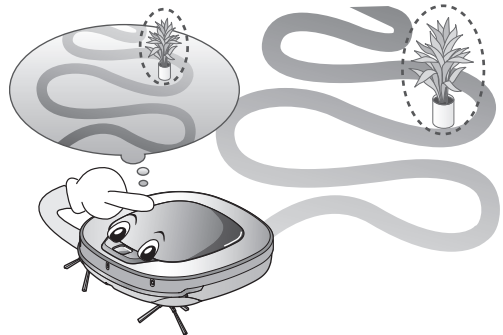





Tip

- Precautions with the Learning mode
- The Learning mode memorizes locations of obstacles in order to avoid them. The Robot Cleaner memorizes every aspect of the environment it encounters from when it leaves the home station to start cleaning to the moment it returns.
- If the home station is moved, the Robot Cleaner must learn the environment again.
- Once the Learning mode is complete, an alert message will sound.

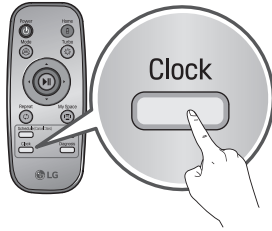
SETTING THE CLOCK

You can set or change the current time on the Robot Cleaner.
Pressing the Clock button on the remote when the Robot Cleaner is in standby mode starts the clock setting mode.

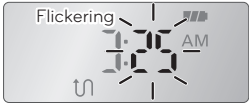

 <p>Select by using ◀▶ buttons on the remote.</p> <p>The function can be heard through the voice guide.</p>		Set the hour by using ▲▼ buttons on the remote.
		Set the minutes using ▲▼ buttons on the remote.
		Set AM/PM using ▲▼ buttons on the remote.
		Pressing the Clock or ▶▶ button on the remote will complete the time setting process.



Tip

- Any scheduled cleaning will be activated based on the time on the Robot Cleaner. The clock must be set before scheduled cleaning can be set.
- If there is no input for 10 seconds, the clock setting is canceled.

SCHEDULING CLEANING

Cleaning can be scheduled so that the Robot Cleaner starts cleaning at a scheduled time. Press the Schedule button on the remote while the Robot Cleaner is recharging to set a scheduled cleaning.

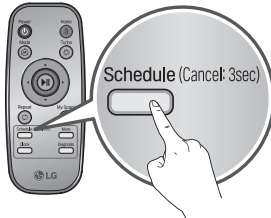

Setting/Canceling a scheduled cleaning is only possible when the unit is recharging on the home station

		<p>Select Schedule Once or Schedule Daily option using the ▲▼ buttons on the remote. A voice message confirms the schedule.</p>
<p>Select a setting by using ► buttons on the remote.</p>		<p>Set the hour using the ▲▼ buttons on the remote.</p>
Schedule Once Schedule Daily		<p>Set the minutes using the ▲▼ buttons on the remote.</p>
		<p>Set the AM/PM using the ▲▼ buttons on the remote.</p>
		<p>Press Schedule or ► button on the remote to complete the process.</p>

- Tip**
- When the scheduled time comes up, the Robot Cleaner starts cleaning by itself.
 - Scheduled cleaning can only be set when the Robot Cleaner is recharging.
 - Pressing the Schedule button on the remote for three seconds while the Robot Cleaner is recharging cancels the set schedule.
 - If there is no input when setting the schedule time within 10 seconds, the setting is canceled.

MOP CLEANING (on some models)

Remove dust on hard floors by attaching the ultra microfiber mop to the Robot Cleaner.

When the mop plate is attached, the Robot Cleaner will not climb on to carpets or over thresholds, in order to prevent transferring dirt from the mop.

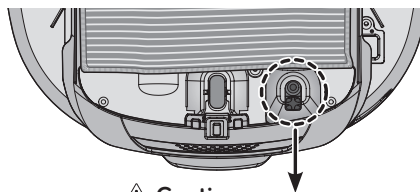

⚠ Caution

Do not cover the bottom camera sensor with the mop.

For mop cleaning, mount the mop and mop plate to the Robot Cleaner according to the following instructions:

1. Attach the ultra microfiber mop to the Velcro of the mop plate as shown in the figure.

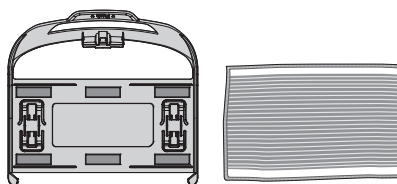

2. Firmly slide the mop plate into the grooves until you hear a click.

※ If the mop plate is not secured correctly, it may separate during cleaning.

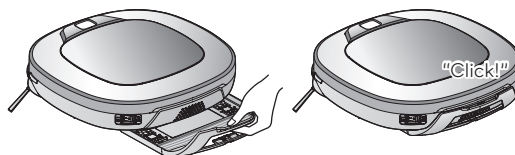

3. It is essential that the fixing hooks on the mop plate align correctly with the fixing grooves on the underside of the cleaner.

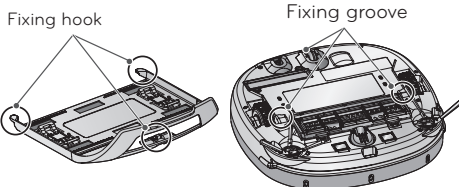

Tip

- To avoid odors, wash any foreign material or dust off the mop after cleaning is completed.
 - To avoid staining floors, do not use the ultra microfiber mop to clean when dirt is contaminated with liquids such as coffee or ink.
 - To avoid damage to carpets from the Velcro or dirt transfer from the mop, do not attempt to clean carpets while the mop plate or mop is attached.
 - Keep the ultra microfiber mop dry. Do not use it on wet surfaces.
- If there is moisture on the floor, it can interfere with the navigation and damage the unit.
- The Smart Diagnosis™ feature is not available when the mop plate is attached.

LOCATION SEARCH FUNCTION

The Robot Cleaner remembers its location while cleaning. If the user moves the Robot Cleaner while it is operating, it will search for the location it was moved from by using its navigational location search function before continuing to clean.

- * The navigational function is activated after the Robot Cleaner adequately recognizes the cleaning environment.

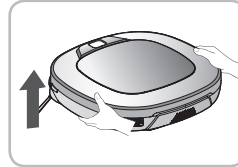

Change location

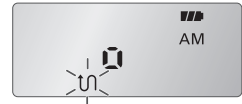

When the location search function is activated, the cleaning mode of the status indicator will flash

Manual Relocation.

1. With the power off, locate the Robot Cleaner near where it was originally moved from.
 - * The location search is more effective when the Robot Cleaner is closer to the location where it was moved from.
 - * If it is moved from its original cleaning position by more than 3¹/₄ ft. (1 m), it becomes difficult for the Robot Cleaner to search for its previous location.

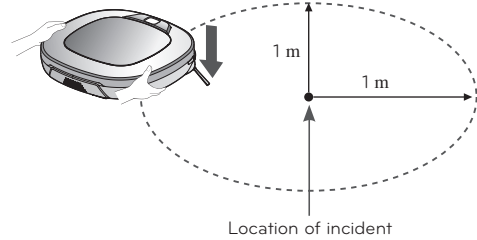

2. Press the START/STOP button on the Robot Cleaner or the **▶||** button on the remote. The Robot Cleaner starts the location search function along with an audio guide.
 - * When the location search is successfully completed, the Robot Cleaner continues cleaning from where it was moved.
 - If the location search fails, cleaning starts again from the beginning.

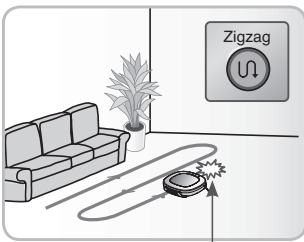

Location of incident

To find exact location, please step away from the Robot Cleaner.

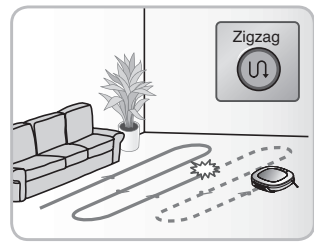

- Tip**
 - If the power is turned off after the location search function is set, the location search function is canceled.
 - Location search is more effective when the Robot Cleaner is closer to the location it was moved from.

SMART DIAGNOSIS™

Robot Cleaner uses the Smart Diagnosis feature to run a self-diagnosis. If any irregularity is found from the diagnosis, contact the local LG Electronics service center.

✳ **During Smart Diagnosis, the Robot Cleaner moves about within a 1¹/₅ ft. (50 cm) radius. So, make sure no objects are in the way within a 3³/₄ ft. (1 m) radius around the home station, before starting Smart Diagnosis.**

1. Smart Diagnosis will operate when the main power switch of the Robot Cleaner and the home station are turned on, and the unit is docked on the home station.

✳ **Smart Diagnosis is only possible when the Robot Cleaner is attached to the home station.**



2. Press the Diagnosis button on the remote, then the process will start with a voice message which says "Robot Cleaner Smart Diagnosis will be started. Please step away and clear around 1 meter around the home station."

✳ **If the Mop Plate is attached, the process will not be activated.**



3. When the Smart Diagnosis has successfully finished, Robot Cleaner will return back to the Home Station and inform you of the result through a voice message. After the voice message, pressing the Home button on the remote or main unit will allow the voice message to be repeated. To terminate the diagnosing process, press the ►► button on the remote or main unit.

✳ **After the Smart Diagnosis voice message, the Robot Cleaner will start recharging after 1 minute.**

✳ **If an error is detected with any of the sensors while in Smart Diagnosis, a voice message will announce, and the unit will not return to the home station.**

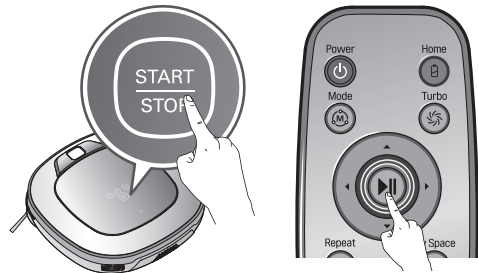

- ☑ **Tip**
- Be careful not to touch the Robot Cleaner or disturb its operation before Smart Diagnosis is complete. If it is accidentally interrupted, turn the main power switch OFF then ON again to resume the diagnosis.
 - Smart Diagnosis will not be activated in each of the following cases. In each case, check the problem and try again.
 - Robot Cleaner is detached from the home station.
 - Battery level is insufficient
 - No Dust Bin Filter is fitted.
 - Mop Plate is attached

SMART DIAGNOSIS™

Refer to the following table to resolve error messages encountered during Smart Diagnosis.

Voice message	Solution
Robot Cleaner Smart Diagnosis will be started. Please step away and clear around 1 meter around the home station.	Clear any object within a 31/4 ft. (1 m) radius around Home Station, and stay back until the diagnosis is complete.
Smart Diagnosis can start when it is being charged. Please dock Robot Cleaner to the home station to charge.	Move Robot Cleaner to the Home Station to recharge it.
No defect found during diagnosis.	
Diagnosis mode cannot be operated due to a low battery. Please try again after the battery is charged.	Try the Smart Diagnosis again after recharging the battery.
Please check if the dust bin is installed with the filter.	Open the Dust Bin Cover and examine the bin.
Charging cannot be done due to a problem in infrared sensor.	Run Smart Diagnosis again and, if the same message is announced, contact an LG Electronics service center.
Charging cannot be done due to a problem in ultrasonic sensor.	Run Smart Diagnosis again and, if the same message is announced, contact an LG Electronics service center.
Charging cannot be done due to a problem in the cliff detection sensors on the bottom. Please clean the sensors.	Clean the three Cliff Sensors on the bottom at the front of the unit.
Please wipe the lower camera sensor on the right bottom of the Robot Cleaner.	Clean the lens of Camera Sensor on the bottom-right.
Please wipe the obstacle detecting sensor window on the left and right side of the Robot Cleaner.	Clean the lens of the Obstacle Sensors on both the left and right hand sides.
A problem has been found on the Gyro Sensor.	Run Smart Diagnosis again and, if the same message is announced, contact an LG Electronics service center.
Please check for dirt on the left wheel.	Check for foreign materials on the left wheel.
Please check for dirt on the right wheel.	Check for foreign materials on the right wheel.
A problem has been found on the left wheel sensor.	Run Smart Diagnosis again and, if the same message is announced, contact an LG Electronics service center.
A problem has been found on the right wheel sensor.	Run Smart Diagnosis again and, if the same message is announced, contact an LG Electronics service center.
Please check the brushes for obstructions.	Check for any foreign material stuck in the Brush.
A problem has been found in the suction motor.	Run Smart Diagnosis again and, if the same message is announced, contact an LG Electronics service center.
A problem has been found in the acceleration sensor.	Run Smart Diagnosis again and, if the same message is announced, contact an LG Electronics service center.
In order to listen to the Smart Diagnosis result again, please press the charging button. To stop, please press the stop button.	If you need to repeat the diagnosis result, press the Home button, or press ▶ button to finish the diagnosis.
Smart Diagnosis mode will be turned off.	
Please try Smart Diagnosis again after turning the main power switch off and on from the back of Robot Cleaner. If the problem continues, please contact LG Electronics customer care.	
Smart Diagnosis mode cannot be operated with mop plate being attached. Please try again after removing it.	Run Smart Diagnosis again after removing the Mop Plate.
Smart Diagnosis has failed to operate. Please try it again after turning off and on the main power switch on the back of the Robot Cleaner.	Turn the main power switch OFF and then ON again to resume the diagnosis. Do NOT touch the robot or disturb its operation until the diagnosis is complete.

CLEANING THE DUST BIN

If the dust bin is full, suction power can be reduced. Clean the dust bin before or after each cleaning session. Clean the dust bin using the following sequence:

1. Open the dust bin compartment cover by pressing the PUSH button on the Robot Cleaner.
2. Grab the handle of the dust bin and pull it upward.
3. Pull the hook on the left of the filter cover on the rear of the dust bin to separate the filter and the sponge.
* Note that separating the filter may result in dust dropping.
* Refer to p.34 when cleaning the dust bin filter.
4. Lift the dust bin lid upward while pressing the separation button on the dust bin.
5. Empty the dust bin and clean it with a cleaning brush or under running water.
6. After cleaning with water, completely dry the dust bin in a well-ventilated area out of the direct sunlight.
7. Reassemble the dust bin, putting the sponge and particulate filter back in and closing the lid.
* Refer to p.34 for detailed assembly guides.
8. Put the dust bin into the Robot Cleaner and close the dust bin compartment cover.

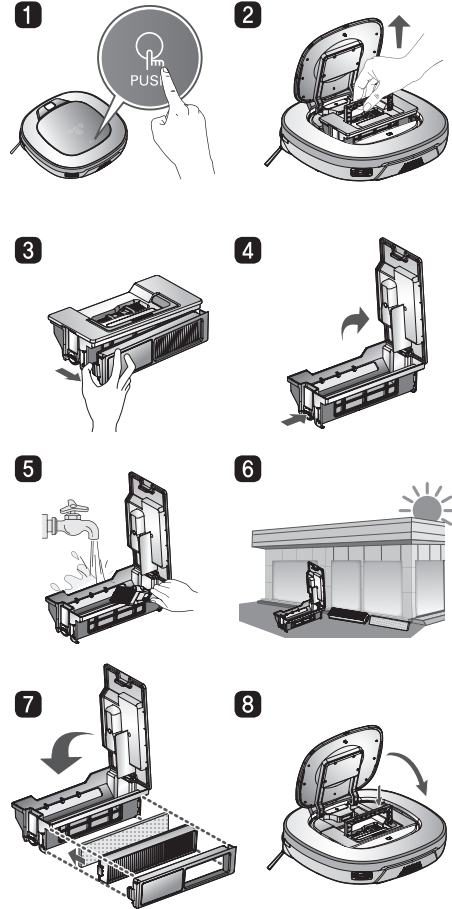

Tip

- Operating the unit without filters fitted to the dust bin can cause a motor malfunction not covered by the warranty.
- After cleaning the dust bin, make sure to assemble the filter and fit it to the dust bin. If the filters are not installed and the filter cover assembled before cleaning is started, an error message will sound.
- Always ensure that the dust bin lid is refitted correctly after cleaning the dust bin so that it closes easily and accurately.

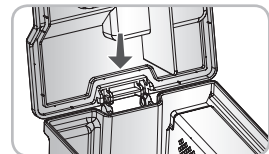

CLEANING THE DUST BIN FILTER

The Dust Bin Filter consists of a particulate filter and a sponge filter. Clean both the particulate filter and sponge filters using the following sequence.

1. Pull the hook on the left of the particulate filter module on the rear side of the dust bin to separate the particulate filter and the sponge filter.

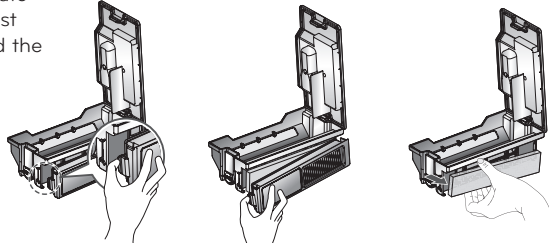

2. Thoroughly clean out the fine dust particles on the particulate filter with a vacuum cleaner or cleaning brush.

※ Do NOT wash the particulate filter with water. Its suction power will be reduced.

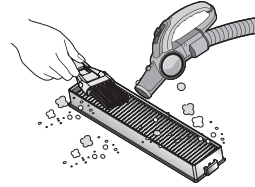

3. Use a cleaning brush to clean the sponge filter. If using water to clean it, allow it to dry completely in the shade before refitting.

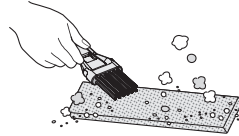

4. Assemble the particulate filter and sponge filters back onto the filter housing using the following sequence.

※ Fit the rectangular locator on the particulate filter into the locating slot of the filter body.

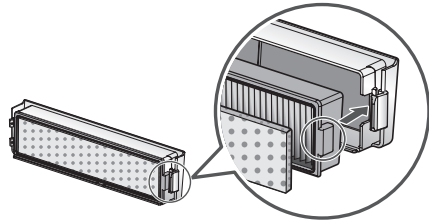

※ Be careful not to incorrectly assemble the particulate filter and sponge filter onto the filter housing.

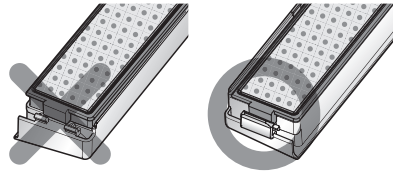

Tip

- To preserve the performance of the Robot Cleaner, clean the particulate filter at least once a week, with a brush or vacuum cleaner.
- The particulate filter and sponge filters must be fitted to the filter housing before refitting the filter to the dust bin. Operating the Robot Cleaner without the particulate filter and sponge filters will cause the suction motor to malfunction.

CLEANING THE BRUSH

The rotating brush, located on the bottom of the Robot Cleaner, helps collect dust. Clean the brush using the following sequence.

*** Before turning over the main unit, lay a soft cloth on the floor and remove the Dust Bin. Otherwise, the main unit can get scratched and dust will fall from the Dust Bin.**

- 1** Turn the main power switch OFF before starting to clean. Put the Robot Cleaner upside down on a soft cloth.
- 2** After checking for foreign materials, press down on the Fixing Hook and pull it up to separate the brush cover.
- 3** Using the cleaning tool, clear hairs and other debris and foreign materials on the brush and from the two smaller jockey wheels.

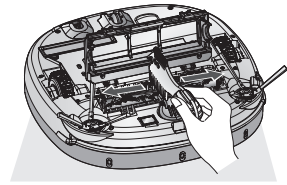
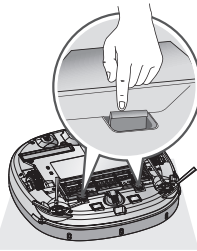
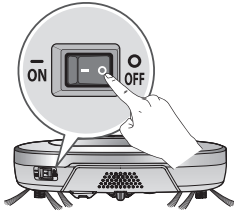

- 4** Push the brush all the way into the yellow protrusion.
- 5** While pushing the brush, lift the white protruding part up to separate it from the main unit.
- 6** Carefully clean the brush with a vacuum cleaner or scissors.

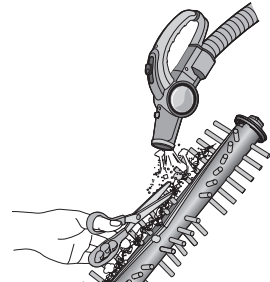
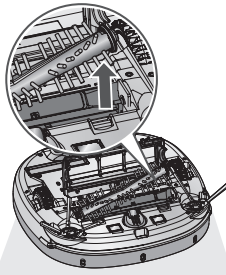
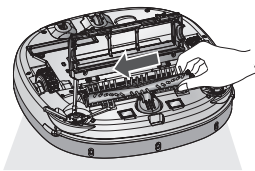

- 7** Fit the fixing hook (rectangular shape) on the side of the brush into the slots, with the colors matching.
- 8** While pushing the brush in the direction of the arrow, fit the fixing hook (rectangular shape) on the opposite side into the slot.
- 9** Press down and close the cover until the fixing hook snaps into place on both sides.
*** Be careful not to trap the side brush bristles under the cover when closing it.**

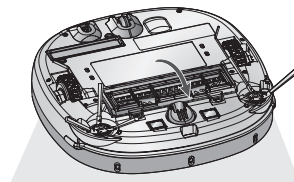
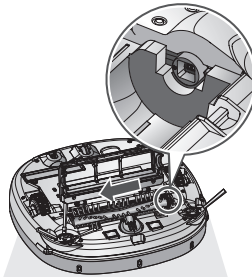
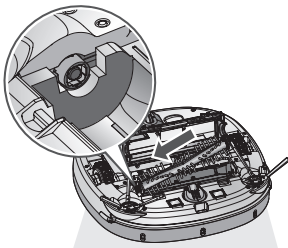

CLEANING THE SENSORS/CHARGING TERMINALS

There are sensors on the Robot Cleaner that detect obstacles, stairways and the home station for charging the battery. In order to maintain the performance of the Robot Cleaner, regularly clean the sensors and charging terminals as follows:

1. Turn off the power switch on the rear side of the Robot Cleaner.
Injury can be caused by the activation of the Robot Cleaner if the main power is not turned off.
2. Lay a smooth cloth on the floor, turn over the Robot Cleaner and put it on the cloth.

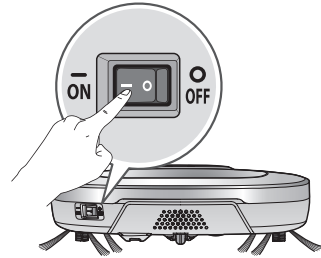

*** Make sure to remove the dust bin before rotating the main body. Otherwise, the dust in the dust bin may fall out.**

3. Use a smooth cloth or cleaning brush to wipe the dust off each of the 3 cliff sensors, camera sensors and ultrasonic sensors and the charging terminal as described below.

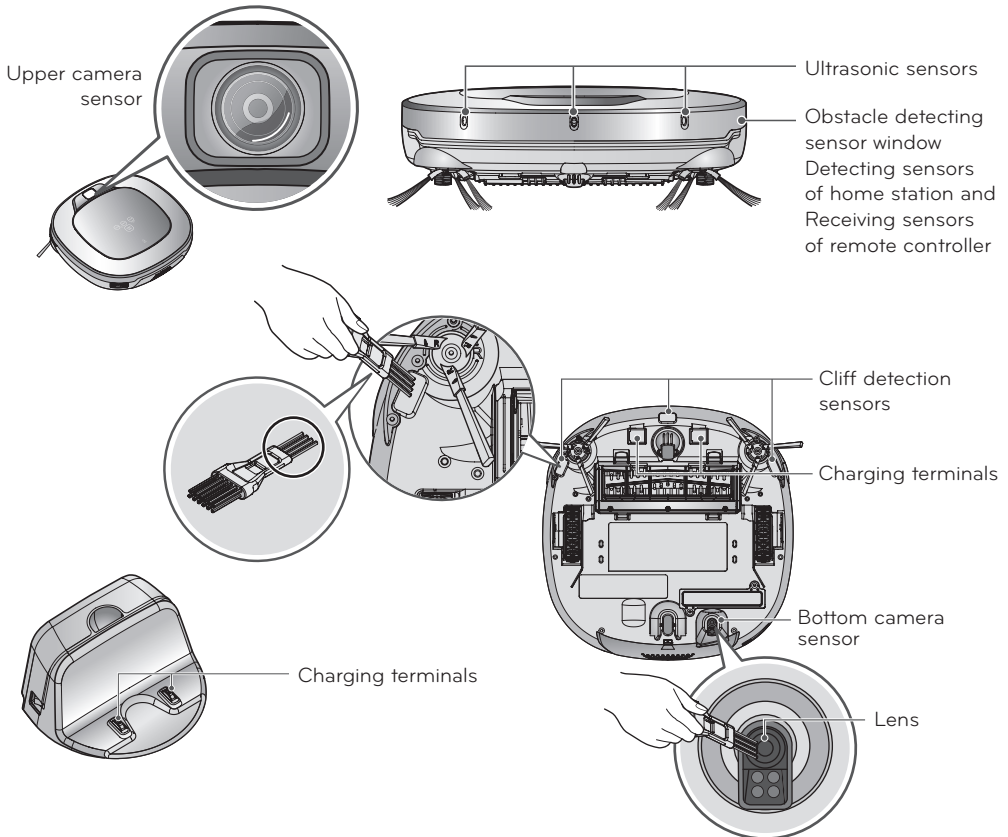

Tip

- Do not clean the Robot Cleaner by directly spraying it with water, thinners, solvents, benzene, or any other liquids.
- Call the service center if the sensor or charging terminal is damaged. Sensor and terminal damage can cause the product to malfunction.
- Use the cleaning brush to clean the sensor/charging terminals.

CLEANING THE SIDE BRUSH

Foreign objects/materials such as hair can easily adhere to the side brush. Remove such materials at least once a week.

If excessive amounts of foreign materials are stuck to the brush, there is the risk of damage to the brushes.

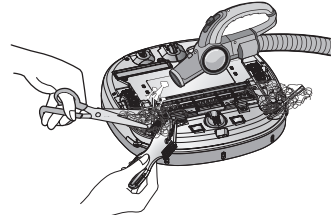

If the floor is rough or frequently cleaned, the side brushes may bend or become deformed. In this case, use the following method to straighten the side brush.

1. The following procedure is helpful in restoring deformed brushes.
2. Turn off the power by switching the main switch off on the rear of the unit.
3. Place the Robot Cleaner at the end of a table to make cleaning the side brush easier. Make sure that the Robot Cleaner is not in danger of falling.
4. Soak the side brush in warm to hot water.
5. Press down on the side brush for about ten seconds so that it is completely submerged in the water.
6. Slowly wipe the side brush by sliding it through your hand.
7. Rotate the side brush and repeat steps 4-6 for each section of the brush.
8. Use the side brush only after it has completely dried.

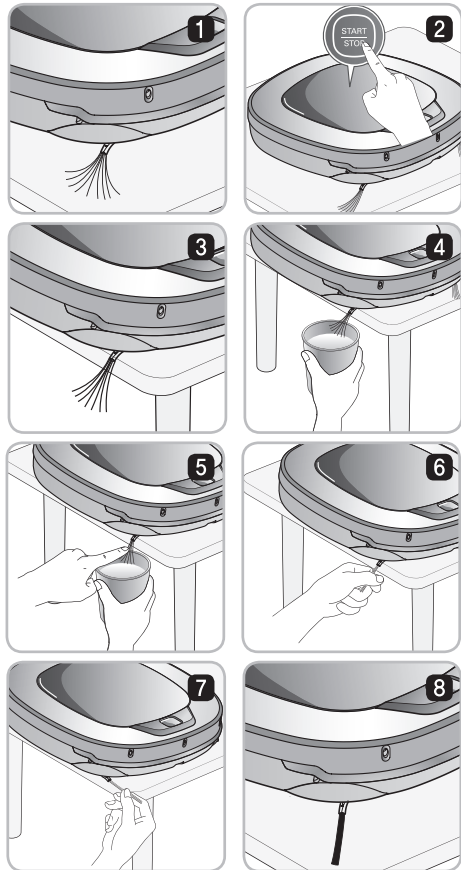

Side Brush Management

1. Remove the screws by using a suitable screw driver and separate the side brush from the main unit.
2. Remove any hair after the separation.
3. Assemble the side brush by replacing it onto the bottom of the Robot Cleaner, with the 'R' and 'L' marking of the brush matching the counterparts on Robot Cleaner.

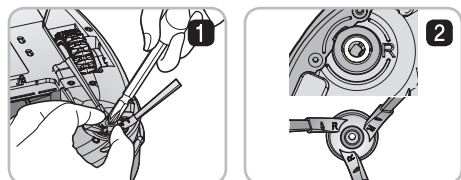

CLEANING THE ULTRA MICROFIBER MOP (on some models)

To avoid odors, dirt and dust should be washed off the mop after it is used for cleaning. Follow these directions to wash the ultra microfiber mop:

1. Separate the ultra microfiber mop from the mop plate.

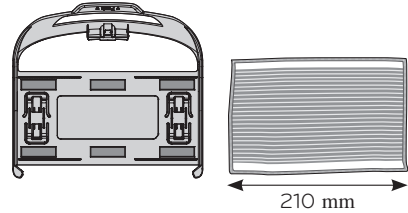

2. Carefully clean it with warm water.



3. Use the mop after completely drying it in direct sunlight.

※ If the mop is used in a damp or wet state, it will cause the Robot Cleaner to malfunction.

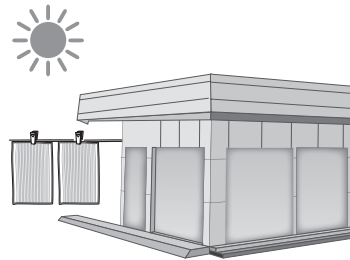

Tip

- To avoid product malfunction, only use the ultra microfiber mop provided with the Robot Cleaner.
- Additional microfiber mops can be purchased by visiting a nearby LG Electronics service center.

TROUBLESHOOTING

"The wheels are not touching the floor. Please move Robot Cleaner onto flat floor."

A warning message will be given if a wheel does not contact the floor surface for any reason.

- Is a wheel trapped in the front door, balcony, stairway, etc?
 - ▶ Move the Robot Cleaner on to a flat floor.



"Please remove foreign material on the left/right wheel."

- Is any foreign material wound around the wheel?
 - ▶ Turn off the main power switch on the rear side of the Robot Cleaner. Then lay a soft cloth on the floor, turn over the Robot Cleaner, and put it on the cloth. Remove foreign material after observing the wheels.
 - ※ Please make sure to remove the dust bin before turning over the main body. Otherwise, the dust in the dust bin may fall out.

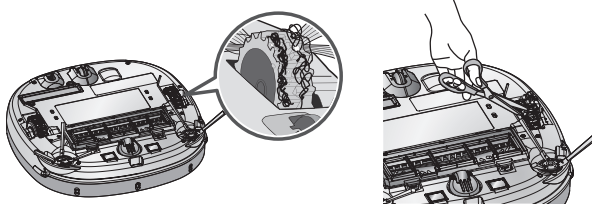

"Robot Cleaner cannot continue cleaning. Please check the area around Robot Cleaner."

A warning message will be given if the Robot Cleaner cannot go on cleaning due to any unfavourable condition.

- Is the Robot Cleaner stuck?
 - ▶ After removing it from the obstacle, place the Robot Cleaner back onto the flat floor.

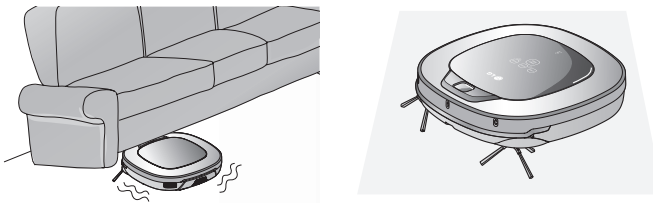

TROUBLESHOOTING

"Please check if the dust bin is installed with the filter."

A warning message will be given if there is no dust bin or filter housing fitted.

- Is the dust bin fitted to the Robot Cleaner?
 - ▶ Open the dust bin compartment cover and check to ensure the dust bin is in place.
 - ▶ Do NOT leave the dust bin cover open.

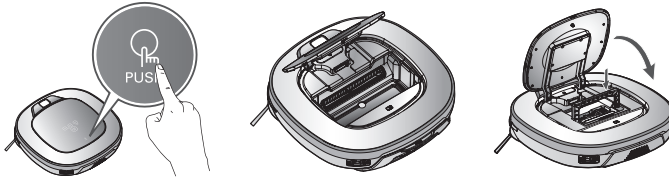

- Make sure the filter housing is assembled onto the dust bin.

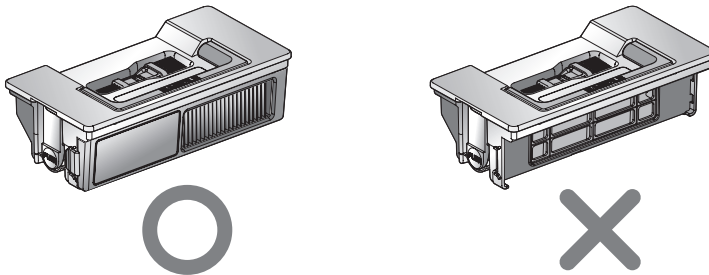

"Battery is low. Please move Robot Cleaner onto the home station to charge."

When the remaining amount of battery power is very low, the voice alert, "Battery is low", is generated.

- Initiate battery charging of the Robot Cleaner by moving it to the home station.
 - ▶ When the Robot Cleaner is attached to the docking station successfully, it will start the recharging with the recharging start melody.

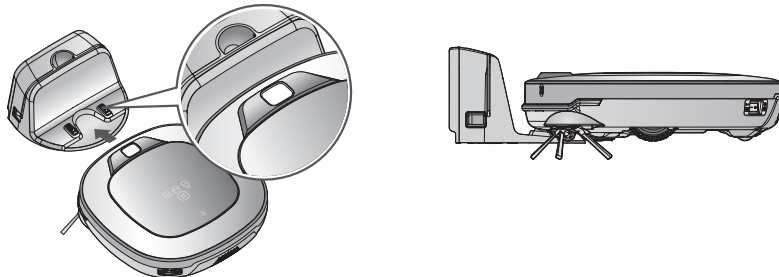

TROUBLESHOOTING

"Please remove foreign material from the brushes on the bottom."

A warning message will be given if foreign materials restrict the brush's rotation.

Turn off the main power switch on the rear of the Robot Cleaner. Lay a soft cloth on the floor and put the Robot Cleaner upside down on it.

※ **Before turning over the main unit, remove the Dust Bin.**
Otherwise, it will cause dust to fall from the Dust Bin.

• The brush is making a loud, abnormal sound.

- ▶ Confirm the correct assembly of the brush by checking the separation groove of the brush
- ▶ Remove the lower rotating brush from the Robot Cleaner and remove any foreign material from the brush.

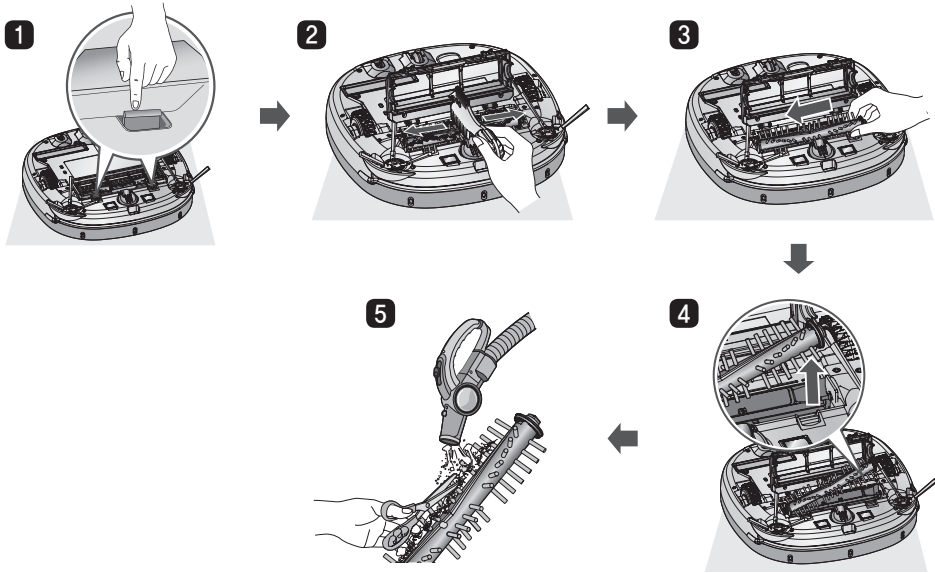

• The lower rotating brush or side brush is stuck.

- ▶ Remove any foreign materials such as cables, thread or hair caught in the side brushes or the lower rotating brush.

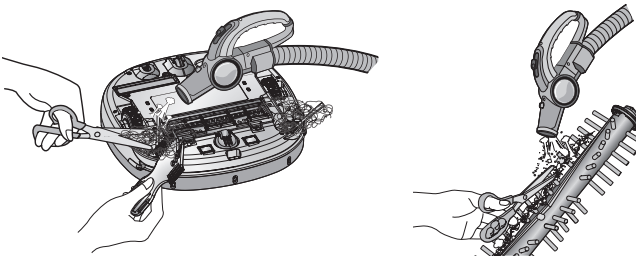

※ For a more detailed description of this process, refer to the instructions on pages 35 and 37.

BEFORE YOU CALL FOR SERVICE

Check the following before you call for service.

Problem	Solutions (Reference page)
The power supply cannot be turned on.	Check that the power switch is turned on. (Page 18)
The power supply automatically turns off.	This is not a failure. Robot Cleaner has its own power saving function. If it is not used for ten minutes after the power supply is turned on, the power will automatically turn off. (Page 20)
The Robot Cleaner will not charge.	<ul style="list-style-type: none"> ▶ Check whether the main power switch is turned on. ▶ Remove objects around the home station. (Page 18) ▶ Confirm that the power supply is connected to the home station. (Page 17) ▶ Wipe the charging terminals with a dry cloth.
Suction power becomes weak.	<ul style="list-style-type: none"> ▶ Check whether there is foreign material blocking the suction port. (Page 35) ▶ Empty the dust bin. (Page 33) ▶ Clean the dust bin filter. (Page 34)
Noise becomes louder.	<ul style="list-style-type: none"> ▶ Confirm that the dust bin has been mounted properly. ▶ Confirm that the dust bin filter has been mounted properly. (Page 34) ▶ Check whether foreign material is caught in the brush. (Page 35)
The Robot Cleaner will not activate.	<ul style="list-style-type: none"> ▶ Confirm that the power switch is turned on. (Page 18) ▶ Confirm that the battery has been charged. (Page 21)
The lower brush does not rotate.	<ul style="list-style-type: none"> ▶ Clean the brush. (Page 35) ▶ Confirm that the brush has been mounted properly. (Page 35)
Movements or travel path are abnormal.	<ul style="list-style-type: none"> ▶ Carefully wipe the sensors with a dry soft cloth. (Page 36) ▶ If the ultra microfiber mop is attached, confirm that it is mounted properly. (Page 29) ▶ Turn the main power switch off and on.
The Robot Cleaner cannot be activated with the remote control.	<ul style="list-style-type: none"> ▶ Replace the remote control batteries. (Page 15) ▶ Confirm that the control is within the coverage area of the main unit, which is less than 3 m. (Page 15) ▶ Check whether the main power switch is turned on. (Page 18)

PRODUCT SPECIFICATIONS

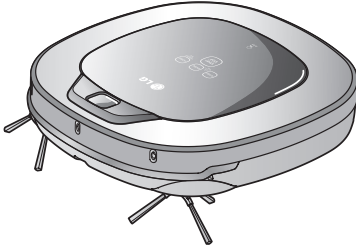

* This equipment is a Class B digital device that complies with 47 CFR Parts 2 and 15 of the FCC Rules. Operation is subject to the following two conditions: (1) This device may not cause harmful interference, and (2) this device must accept any interference received, including interference that may cause undesired operation.

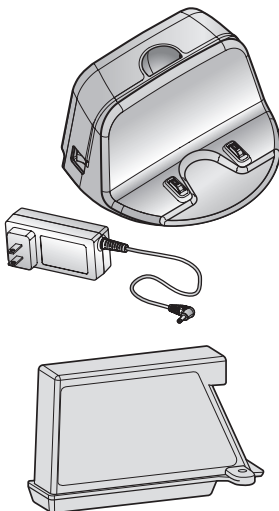

Item/Model	LG Robot Cleaner VR657*** Ser / VR655*** Ser
External Dimensions	13.4 inch x 13.4 inch x 3.5 inch (340 mm x 340 mm x 89 mm)
Weight	6.6 lb (3 kg)
Power Consumption	58 W
Battery (Fully Charging)	DC 16.8 V
Traveling Velocity	1.38 inch/s (350 mm/s) (Maximum)
Use Time	Approx. 100 minutes (Based on general wooden floor)
Charging Time	3 hours
Main Functions	Turbo Mode Learning Mode Obstacle Sensing Anti-Plunge function Scheduled Cleaning Error Displaying Navigation Auto/Manual Recharging Dry Mopping (cleaning) (Option) Corner Clean Voice Messaging Map Drawing Spot Cleaning Repeat Cleaning My Space Cleaning Cell by Cell cleaning Zigzag Cleaning

Item/Model	Home Station (VR650) EPS : ADS-30FSA-17 17030EPCU
External Dimensions	9.3 inch x 7.1 inch x 5.0 inch (236 mm x 181 mm x 128 mm)
Rating	120 V~ 60 Hz
Output Voltage/Current	DC 17.1 V / 1.7 A
Power Consumption	30 W

Item/Model	Battery(EAC62218205)
Type	Lithium Battery
Rating	DC 14.4 V / 2330 mAh / 4 cells
Charging temperature	Standard charge at 23±5 °C
Number of Batteries	1 EA

REFERENCE ITEMS

Open source software notice

To obtain the source code under GPL, LGPL, MPL and other open source licenses, that is contained in this product, please visit <http://opensource.lge.com>.

In addition to the source code, all referred license terms, warranty disclaimers and copyright notices are available for download.

Removing / Refitting the battery pack

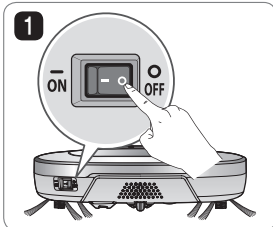

Turn off the main power switch on the back-left side of the Robot Cleaner.

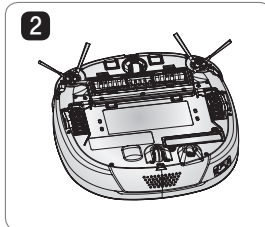

Place a soft cloth on the floor, remove the dust bin, and flip the Robot Cleaner over.

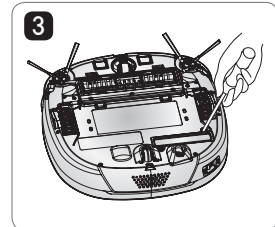

Remove the screws by using a Phillips head screwdriver.

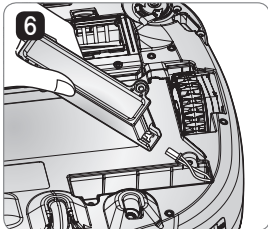

Refit the battery in the reverse order.

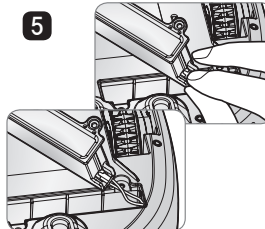

Press the connector release lug on the connecting plug to disconnect the battery wiring.

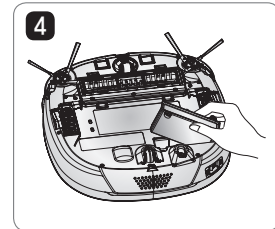

Remove the battery from the device.

WARNING

Please be careful of fire, explosion, electric shock, or breakdown.

- Do not charge this Battery Pack with any other type of charger other than the one originally provided with the Robot Cleaner.
- Do not damage the battery pack in such ways as dropping, crushing, cutting, or shorting external contacts.
- Do not attempt to disassemble the battery pack in any way. If the battery pack is damaged or malfunctioning, bring it and the Robot cleaner and home station to an authorised service center.
- Do not place the battery pack near a heat source or dispose of it in fire or water.
- Please keep the battery pack away from any damp or wet environment when the pack is charged.
- Please keep the battery pack away from children, infants or pets.

PERFORMANCE TESTING (IEC 62929 Standard)

Dust Removal Test - Box(Hard Floor & Carpet)

1. Put fully charged Robot Cleaner down on start point and turn on.
2. Push TURBO button on the Robot Cleaner or Turbo button on the remote and Robot Cleaner will be set to Turbo Mode.
3. Push the Repeat button on the remote and Robot Cleaner will be set to Repeat Mode.
4. Push the START/STOP button on the Robot Cleaner or ►► button on the remote and Robot Cleaner will operate.

Dust Removal Test - Straight Line(Hard Floor & Carpet)

1. Put fully charged Robot Cleaner down on start point and turn on.
2. Push both the Schedule button and the Mode button for 3 seconds to access the Test Mode(Straight).
3. (1) In case of testing on Hard Floor, LED expression : T-H .
(2) In case of testing on Carpet, LED expression : T-C.
* Change LED expression by pushing the Mode button on the remote or the MODE button on the Robot Cleaner.
4. Push the START/STOP button on the Robot Cleaner or ►► button on the remote and the Robot Cleaner will operate.

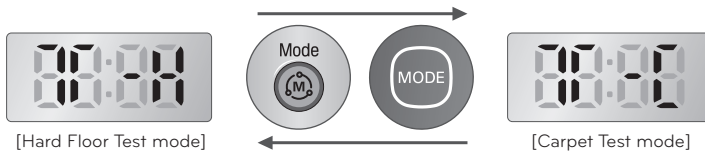

Autonomous navigation/coverage test

1. Put fully charged Robot Cleaner down on start point and turn on.
2. Push the Repeat button on the remote and Robot Cleaner will be set to Repeat Mode.
3. Push the START/STOP button on the Robot Cleaner or ►► button on the remote and the Robot Cleaner will operate.

* Use this mode only when organizations test cleaning performance or driving performance according to IEC62929

LG Robot Cleaner WARRANTY

LG Electronics Inc. will repair or replace your product, at LG's option, if it proves to be defective in material or workmanship under personal household use, during the warranty period set forth below, effective from the date of original consumer purchase of the product. This limited warranty is good only to the original purchaser of the product and effective only when used in U.S.A. and Canada.

*Manufacturing Locations : LG Electronics, Changwon Factory 2 Sungsang Gongdanro 473 road 33, Changwon City, Gyeongnam, 641-711 KOREA

WARRANTY PERIOD:	HOW SERVICE IS HANDLED:
1 Year From the date of the original purchase	Any part of the Robot Cleaner which fails due to a defect in materials or workmanship. During this full 1 Year warranty , LG will also provide, free of charge , all labor and shop service to replace the defective part. Inverter motor : 10 year warranty (Suction motor)

THIS WARRANTY IS IN LIEU OF ANY OTHER WARRANTIES, EXPRESS OR IMPLIED, INCLUDING WITHOUT LIMITATION, ANY WARRANTY OF MERCHANTABILITY OR FITNESS FOR A PARTICULAR PURPOSE. TO THE EXTENT ANY IMPLIED WARRANTY IS REQUIRED BY LAW, IT IS LIMITED IN DURATION TO THE EXPRESS WARRANTY PERIOD ABOVE. LG WILL NOT BE LIABLE FOR ANY CONSEQUENTIAL, INDIRECT, OR INCIDENTAL DAMAGES OF ANY KIND, INCLUDING LOST REVENUES OR PROFITS, IN CONNECTION WITH THE PRODUCT. SOME STATES DO NOT ALLOW LIMITATION ON HOW LONG AN IMPLIED WARRANTY LASTS OR THE EXCLUSION OF INCIDENTAL OR CONSEQUENTIAL DAMAGES, SO THE ABOVE LIMITATIONS OR EXCLUSIONS MAY NOT APPLY TO YOU.

This warranty covers only defects in material and workmanship.

LGE will NOT pay for:

1. Expendable items that can wear out, including, but not limited to, filters and belts.
2. A service technician to instruct the user in correct product assembly, operation or maintenance.
3. A service technician to clean or maintain this product.
4. Damage to or failure of this product if it is not assembled, operated or maintained according to all instructions supplied with this product.
5. Damage to or failure of this product resulting from accident, abuse, misuse or use for other than its intended purpose.
6. Damage to or failure of this product caused by the use of detergents, cleaners, chemicals or utensils other than those recommended in all instructions supplied with this product.
7. Damage to or failure of parts or systems resulting from unauthorized modifications made to this product.

This warranty is extended to the original purchaser for products purchased for home use within the U.S.A. In Alaska, the warranty excludes the cost of shipping or service calls to your home. Some states do not allow the exclusion or limitation of incidental or consequential damages, so this exclusion or limitation may not apply to you. This warranty gives you specific legal rights, and you may also have other rights which vary from states to states. To know what your legal rights are, consult your local or state consumer affairs or your state's Attorney General.

CUSTOMER ASSISTANCE INFORMATION:

To Prove Warranty Coverage	Retain your Sales Receipt to prove date of purchase. A copy of your Sales Receipt must be submitted at the time warranty service is provided.
To Obtain Nearest Authorized Service Center or Sales Dealer, or to Obtain Product, Customer, or Service Assistance	Call 1-800-243-0000 (Phone answered 24 hours - 365 days a year) and choose the appropriate prompt from the menu; or visit our website at: http://us.lgservice.com . (In Canada- Call 1-888-542-2623, website http://ca.lgservice.com)

MEMO





Made in Korea